

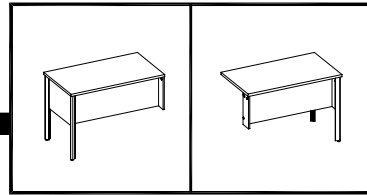

# Assembly Instructions

## Orenda™ Casegoods

### Aluminum Frame Return Rectangle



AKARR

QD-B-DU640	QN000001	QD-CAP-ODO	FER-PLAQUE	VIS7/8X10TRQ	DIV-COUSSINET-TRA
11	2	17	2	16	2

▲ Must be Secured to Another Unit

- 1.** Lay worksurface upside down on soft surface to protect the top. Insert all 11 shoulder screws into the top and end panels. Insert the 2 glides leaving 1/4 inch of adjustment.

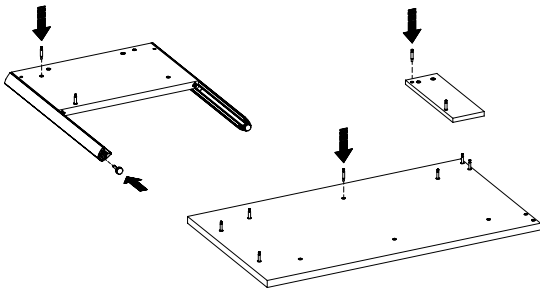

Reversible

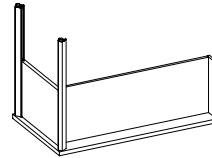

2 possible back positions

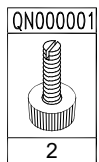
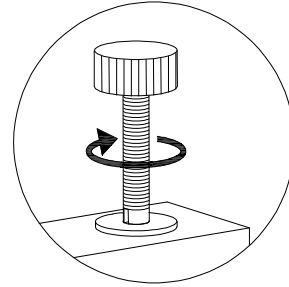
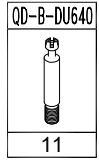
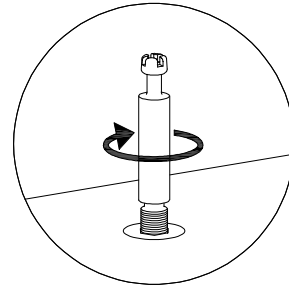
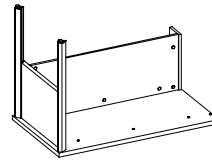

- 2.** Place back panel ① in place then ends ② ③ and then tighten all camlocks (see diagram). Place adhesive cover over visible hardware.

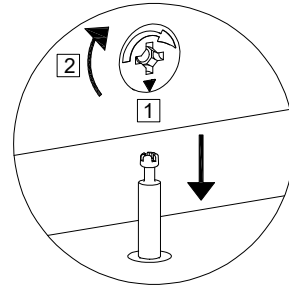
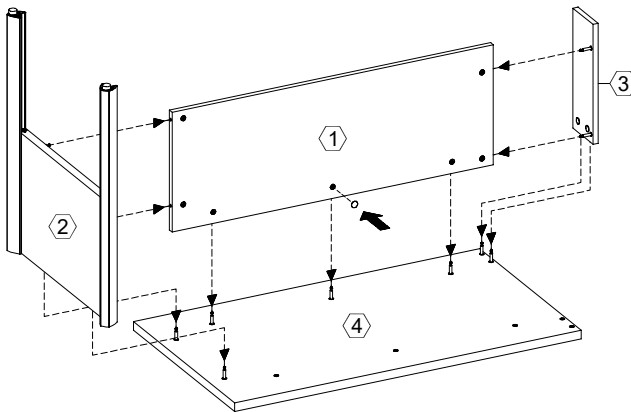

- ① Align arrow orientation to insert part
- ② Lock

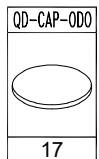
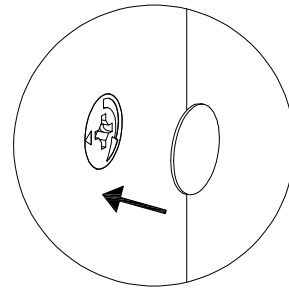

- 3.** Place return unit next to another furniture unit and install splice plates (see diagram).

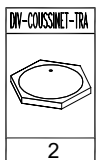
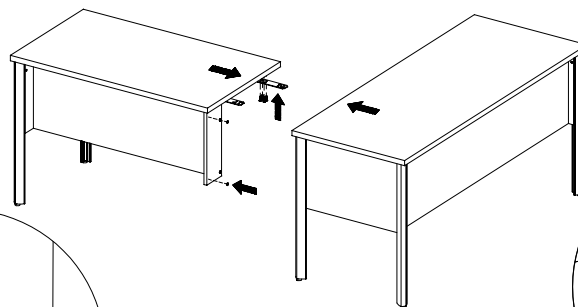

This hardware pad will help maintain an even gap.

