



OVERVIEW

The Planner is ideal for all kinds of classroom activities. The heavy duty construction contributes to a sturdy work surface that can hold 400 pounds. The Planner Activity table is shipped ready to assemble.

MATERIALS

The work surface consists of a 45 lb. density particle board core with a .020" high-pressure laminated surface and a .020" melamine backer sheet. The edge of the work surface features a bumper edge that is mechanically fastened every 6" to 8" to assure a long-lasting fit. The top is pre-drilled for ease of installation.

The frame consists of two fully welded leg segments and a center support channel. The legs are attached to the pre-drilled holes in the top with (16) #10 x 5/8" wood screws through a 3 1/8" w x 28"L 12-gauge steel mounting plate. The mounting plate is welded to (2) 1 1/4" square 12-gauge steel tube legs which is welded to a 1" x 2" 14-gauge steel tube cross bar. The leg inserts are 1" square 14-gauge steel tube and adjust in height from 24" to 34" in 1" increments. Leveling glides are on each table leg allowing for stability on uneven floors. The adjustment for each leg is secured with (2) 3 3/4" -16 x .675" Allen screws. The center support channel is 2" x 3" 14-gauge steel, with 11-gauge steel end plates for maximum stability. The center support channel is connected to the legs by (4) connector bolts.

PLANNER TOP & EDGE PROFILE

1 1/4" TOP W/ BUMPER T-MOLD
NO LETTER TO FOLLOW MODEL NO.



1 1/4" TOP W/ 4MM T-MOLD

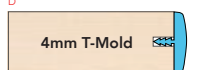

3/4" TOP W/ BULLET T-MOLD



3/4" TOP W/ 4MM T-MOLD

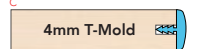

1 1/4" TOP W/ 3MM - 90° CORNERS

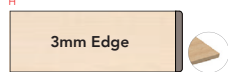

1 1/4" TOP W/ 3MM - ROUND CORNERS

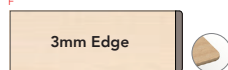

3/4" TOP W/ 3MM - 90° CORNERS



3/4" TOP W/ 3MM - ROUND CORNERS

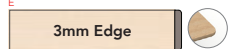

DIMENSIONS

Model	Description	D"	H"	WT
25620	42" Round Activity Table	42 dia.	24-34	86
25630	48" Round Activity Table	48 dia.	24-34	98
25640	60" Round Activity Table	60 dia.	24-34	148

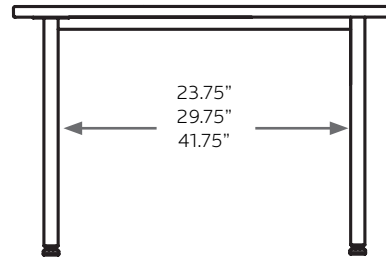

diameter:
42", 48", 60"

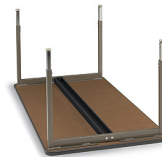
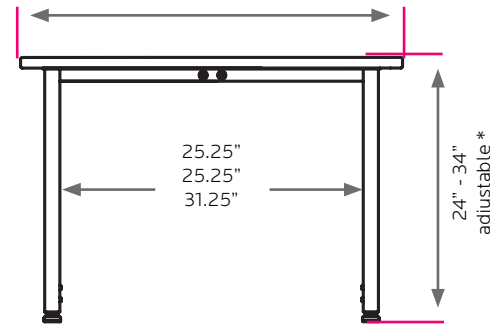

Center support channel is 2" by 3" wide 14-gauge steel, with 11-gauge steel endplates for maximum stability.

STANDARD LAMINATE OPTIONS

Want to specify a different laminate?

No problem. If you have 20 or more tops of the same color -60 or -38 there is no upcharge. Have 20 or less? We can quote for you with the Wilsonart code and - finish style. We can specify other laminates - call to inquire and get a quote.

SUGGESTED SURFACE OPTIONS



ASIAN NIGHT
7949-60



BOARDWALK OAK
7983-60



BUKA BARK
7982-60



CLASSIC LINEN
4943-60



FLAX LINEN
4990-60

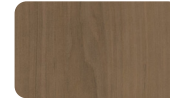

FRENCH PEAR
8220-60



FUSION MAPLE
7909-60



GREY NEBULA
4622-60



HIGH RISE
4996-60



MISSION MAPLE
7990-60



NEW AGE OAK
7938-60



NORTH SEA GRAY
D90-60



PALISADES OAK
7987-60

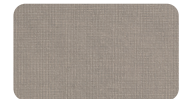

PEWTER MESH
4878-60

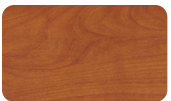

WILD CHERRY
7054-60

All 15 of the standard laminates are -60 finish, if you need to match a laminate from a previous year, please let us know on your order (example Pewter Mesh 4878-38, our standard is -60).

When the WilsonArt Laminate code includes a "Y", "K", "-12", "-78", "Aeon" etc, these are special laminates with an upcharge, even when it contains -38 or -60.

STANDARD EDGE COLOR OPTIONS



APPLE



BLACK



CERULEAN



CHARCOAL



NAVY



PERSIAN BLUE



PLATINUM

LEG COLOR OPTIONS



PLATINUM



BLACK

Alternate leg set heights:

- * Low range available in 15-24"h. Add **L** following model number.
- * Fixed-height leg available in 29.5"h. Add **X** following model number. Available in Black only.

EDGE COLOR OPTIONS WITH ADDITIONAL LEAD TIME



BLUEBERRY



BURGUNDY



CHAMPAGNE



FOREST GREEN



ORANGE



PURPLE



RED



YELLOW



**Make it mobile
with 3" casters**
Order Model 17576