

DEL 106

- Adjustable 355 degree x 180 degree
- Delivered lumen (warm white): 460lm
- Solid brass hardware with powder coat or metal plated finish
- Suitable for task and display lighting applications
- Suitable For 12V AC magnetic transformer
- Suitable For 12V DC electronic constant voltage driver
- Low voltage total power consumption for DEL 106 is 11W
- First photo shown is 5106-SV with Monorail adapter
- When choosing monopoint P1, P2, P3, P4, or P5, you must order proper **transformers** or **drivers**
- This fixture can be mounted on any Prima Lighting System and ceiling canopy through use of an appropriate adapter, see website for available system codes and specialized spec sheets.
- Consult factory for pricing on fixtures connect to multipoint (**M1~ M7 canopy**)

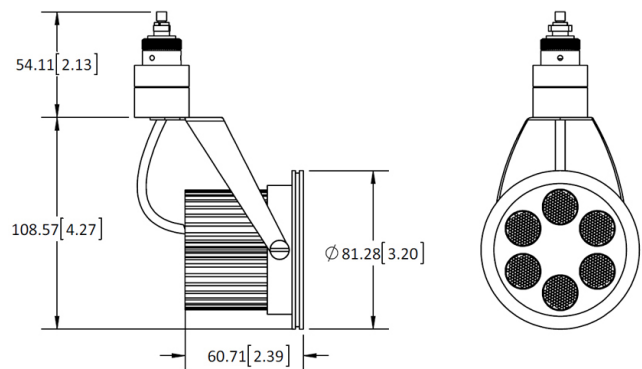

**DIMENSIONS ARE IN MILLIMETERS [INCHES]
(NOT TO SCALE)**

Variable Specs

Note: Variable spec listed below are dependant on system code selection. [Click here to see specific variations.](#)

■ Black ■ Silver or Aluminum

Lamp Type:

- (30K) 3000K
- (40K) 4000K
- (65K) 6500K

Special Note: *All fixtures and lighting systems must be used with dedicated circuit and a Prima transformer, driver, and/or ballast to comply with cUL/cETL listing; or all warranties are void.

REV. 030521

PRIMA LIGHTING

Project Name: _____

Type: _____

SYSTEM CODE:	LUMEN STYLES:	FINISH COLORS:
(10) 120V ADAPTER FOR P-TRACK FIXTURE	Not Available	Not Available
(20) FIT SYSTEM	LD/LO	BK/SV
(25) 120V RETRO-FIT ADAPTER FOR H-TRACK FIXTURE	Not Available	Not Available
(26) 120V RETRO-FIT ADAPTER FOR J-TRACK FIXTURE	Not Available	Not Available
(27) H-TRACK RETRO FIT ADAPTER	LD/LO	BK/SV
(28) J-TRACK RETRO FIT ADAPTER	LD/LO	BK/SV
(29) HOUSING ADAPTER FOR P-TRACK	LD/LO	BK/SV
(40) LOW VOLTAGE MONORAIL SYSTEM	LD/LO	BK/SV
(42) CABLE SYSTEM – 6" WIDTH	LD/LO	BK/SV
(43) CABLE SYSTEM – 2.75" WIDTH	LD/LO	BK/SV
(E1) MONOPOINT 5" CANOPY W/ 120V TO 12V TRANSFORMER	Not Available	Not Available
(E2) MONOPOINT 5" CANOPY W/ 277V TO 12V TRANSFORMER	Not Available	Not Available
(E3) MONOPOINT 5" CANOPY W/ 120V BALLAST OR LED 120V/12V TRANSFORMER	LD/LO	BK/SV
(E4) MONOPOINT 5" CANOPY W/ 277V BALLAST OR LED 277V/12V TRANSFORMER	LD/LO	BK/SV
(E5) MONOPOINT 5.5" CANOPY W/ DIMMABLE 120V~277V BALLAST	Not Available	Not Available
(E6) MONOPOINT 5.5" CANOPY W/ CONSTANT CURRENT DRIVER	Not Available	Not Available
(M1-M7) MULTIPOINT	(CONSULT FACTORY)	(CONSULT FACTORY)
(P1) MONOPOINT DIA. 0.7" W/ THREADED NIPPLE MOUNTING	LD/LO	BK/SV
(P2) MONOPOINT DIA. 1.6" W/ THREADED NIPPLE MOUNTING	LD/LO	BK/SV
(P3) MONOPOINT DIA. 1.6" W/ SCREW/ANCHOR MOUNTING	LD/LO	BK/SV
(P4) MONOPOINT 5" DIRECT MOUNT SQUARE COVER PLATE	LD/LO	BK/SV
(P5) MONOPOINT 5" JBOX PLATE	LD/LO	BK/SV

NOTE: DIMENSIONS ARE IN MILLIMETERS [INCHES]

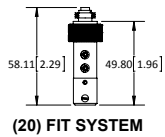

(20) FIT SYSTEM

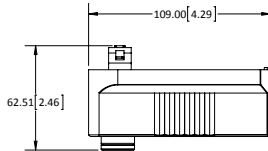

(27) H-TRACK ADAPTER

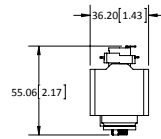

(28) J-TRACK ADAPTER

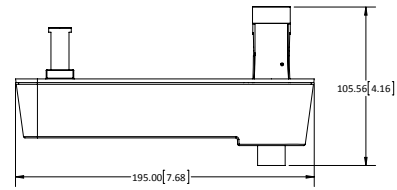

(29) HOUSING ADAPTER FOR P-TRACK

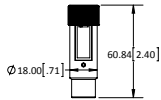

(40) LOW VOLTAGE
MONORAIL SYSTEM

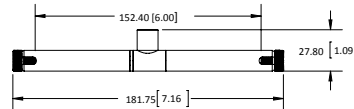

(42) CABLE SYSTEM
- 6.00" WIDTH

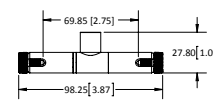

(43) CABLE SYSTEM
- 2.75" WIDTH

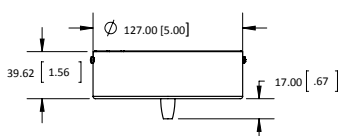

(E3) MONOPOINT 5" CANOPY W/ 120V BALLAST
OR LED 120V/12V TRANSFORMER

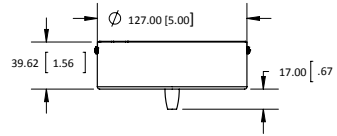

(E4) MONOPOINT 5" CANOPY W/ &+-+V
BALLAST OR LED 277V/12V TRANSFORMER

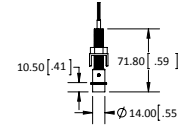

(P1) MONOPOINT DIA. 0.7" W/
THREADED NIPPLE MOUNTING

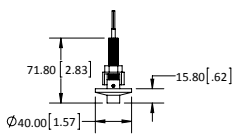

(P2) MONOPOINT DIA. 1.6" W/
THREADED NIPPLE MOUNTING

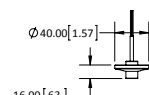

(P3) MONOPOINT DIA. 1.6" W/
SCREW/ANCHOR MOUNTING

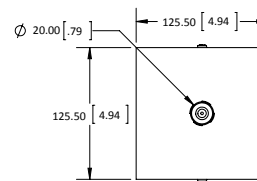

(P4) 5" DIRECT MOUNT
SQUARE COVER PLATE

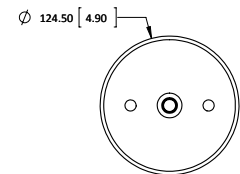

(P5) MONOPOINT 5" JBOX PLATE

Special Note: *All fixtures and lighting systems must be used with dedicated circuit and a Prima transformer, driver, and/or ballast to comply with cUL/cETL listing; or all warranties are void.