

DEL 312

- Adjustable 355 degree x 180 degree
- Delivered lumen (warm white): 900lm
- Solid brass hardware with powder coat or metal plated finish
- Suitable for task and display lighting applications
- Suitable For 12V AC magnetic transformer
- Suitable For 12V DC electronic constant voltage driver
- Low voltage total power consumption for DEL 312 is 21W
- Photo shown is 5912-BK with FIT adapter
- When choosing monopoint P1, P2, P3, P4, or P5, you must order proper **transformers** or **drivers**
- This fixture can be mounted on any Prima Lighting System and ceiling canopy through use of an appropriate adapter, see website for available system codes and specialized spec sheets.
- Consult factory for pricing on fixtures connect to multipoint (**M1~ M7 canopy**)

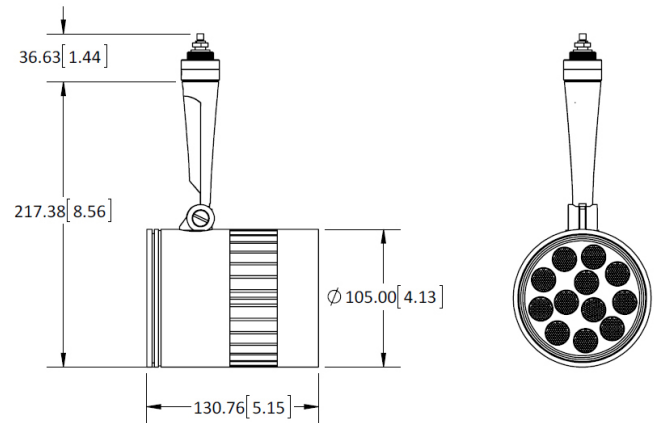

**DIMENSIONS ARE IN MILLIMETERS [INCHES]
(NOT TO SCALE)**

Variable Specs

Note: Variable spec listed below are dependant on system code selection. [Click here to see specific variations.](#)

- Black
 Silver or Aluminum
 White
 Bronze
 Champagne (Matted Gold)

Lamp Type:

- (30K) 3000K
- (40K) 4000K
- (65K) 6500K

Special Note: *All fixtures and lighting systems must be used with dedicated circuit and a Prima transformer, driver, and/or ballast to comply with cUL/cETL listing; or all warranties are void.

SYSTEM CODE:	LUMEN STYLES:	FINISH COLORS:
(10) 120V ADAPTER FOR P-TRACK FIXTURE	LD	BK/SV/WH
(20) FIT SYSTEM	LD/L0	BK/SV
(25) 120V RETRO-FIT ADAPTER FOR H-TRACK FIXTURE	LD	BK/SV/WH
(26) 120V RETRO-FIT ADAPTER FOR J-TRACK FIXTURE	LD	BK/SV/WH
(27) H-TRACK RETRO FIT ADAPTER	Not Available	Not Available
(28) J-TRACK RETRO FIT ADAPTER	Not Available	Not Available
(29) HOUSING ADAPTER FOR P-TRACK	Not Available	Not Available
(40) LOW VOLTAGE MONORAIL SYSTEM	LD/L0	BK/BZ/CP/SV
(42) CABLE SYSTEM – 6" WIDTH	LD/L0	BK/SV
(43) CABLE SYSTEM – 2.75" WIDTH	LD/L0	BK/SV
(E1) MONOPOINT 5" CANOPY W/ 120V TO 12V TRANSFORMER	Not Available	Not Available
(E2) MONOPOINT 5" CANOPY W/ 277V TO 12V TRANSFORMER	Not Available	Not Available
(E3) MONOPOINT 5" CANOPY W/ 120V BALLAST OR LED 120V/12V TRANSFORMER	LD/L0	BK/BZ/CP/SV/WH
(E4) MONOPOINT 5" CANOPY W/ 277V BALLAST OR LED 277V/12V TRANSFORMER	LD/L0	BK/BZ/CP/SV/WH
(E5) MONOPOINT 5.5" CANOPY W/ DIMMABLE 120V~277V BALLAST	Not Available	Not Available
(E6) MONOPOINT 5.5" CANOPY W/ CONSTANT CURRENT DRIVER	Not Available	Not Available
(M1-M7) MULTIPOINT	(CONSULT FACTORY)	(CONSULT FACTORY)
(P1) MONOPOINT DIA. 0.7" W/ THREADED NIPPLE MOUNTING	LD/L0	BK/BZ/CP/SV/WH
(P2) MONOPOINT DIA. 1.6" W/ THREADED NIPPLE MOUNTING	LD/L0	BK/BZ/CP/SV/WH
(P3) MONOPOINT DIA. 1.6" W/ SCREW/ANCHOR MOUNTING	LD/L0	BK/BZ/CP/SV/WH
(P4) MONOPOINT 5" DIRECT MOUNT SQUARE COVER PLATE	LD/L0	BK/BZ/CP/SV/WH
(P5) MONOPOINT 5" JBOX PLATE	LD	BK/BZ/CP/SV/WH

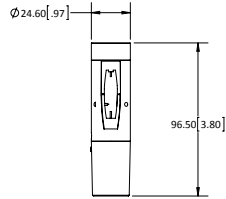

(10) 120V ADAPTER FOR P-TRACK FIXTURE

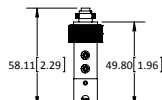

(20) FIT SYSTEM

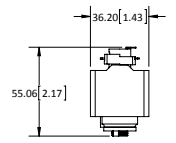

(25) 120V RETRO-FIT ADAPTER FOR H-TRACK FIXTURE

BCH9.8-A9BG-CBG5F9-B'A-@A9HFG0B7<9GQ

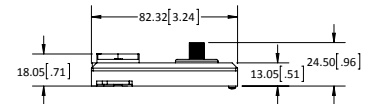

(26) 120V RETRO-FIT ADAPTER FOR J-TRACK FIXTURE

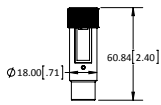

(40) LOW VOLTAGE MONORAIL SYSTEM

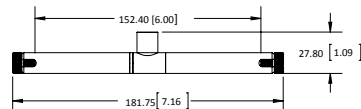

(42) CABLE SYSTEM - 6.00" WIDTH

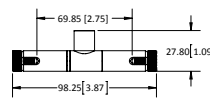

(43) CABLE SYSTEM - 2.75" WIDTH

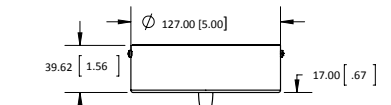

(E3) MONOPOINT 5" CANOPY W/ 120V BALLAST OR LED 120V/12V TRANSFORMER

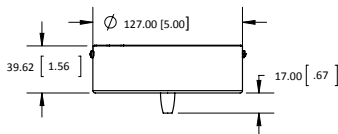

(E4) MONOPOINT 5" CANOPY W/ BALLAST OR LED 277V/12V TRANSFORMER

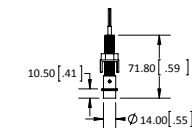

(P1) MONOPOINT DIA. 0.7" W/ THREADED NIPPLE MOUNTING

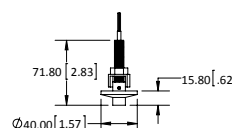

(P2) MONOPOINT DIA. 1.6" W/ THREADED NIPPLE MOUNTING

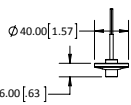

(P3) MONOPOINT DIA. 1.6" W/ SCREW/ANCHOR MOUNTING

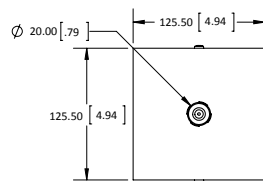

(P4) 5" DIRECT MOUNT SQUARE COVER PLATE

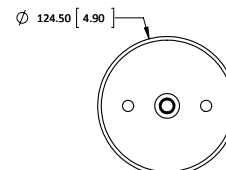

(P5) MONOPOINT 5" JBOX PLATE

Special Note: *All fixtures and lighting systems must be used with dedicated circuit and a Prima transformer, driver, and/or ballast to comply with cUL/cETL listing; or all warranties are void.