

Quasar II

- Single lamp adjustable track head
- Adjustable 355 degree x 90 degree
- Solid brass hardware with powder coat or metal plated finish
- Suitable for task and display lighting applications
- Custom clips required for accessories and/or LED MR16 lamp (sold separately)
- Photo shown is 1 622-BZ with Monorail adapter, 6" extension and Solid Lamp Back Cover catalog no. **90-SB16-BZ**
- Go to [lamps](#) for other options
- Go to [accessories](#) for other options
- When choosing monopoint P1, P2, P3, P4, or P5, you must order proper [transformers](#) or [drivers](#)
- This fixture can be mounted on any Prima Lighting System and ceiling canopy through use of an appropriate adapter, see website for available system codes and specialized spec sheets.
- Consult factory for pricing on fixtures connect to multipoint ([M1~ M7 canopy](#))

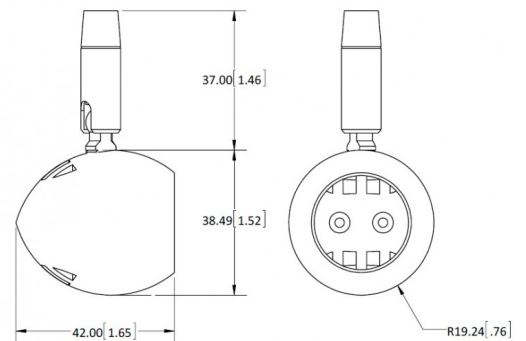

DIMENSIONS ARE IN MILLIMETERS [INCHES]
(NOT TO SCALE)

Variable Specs

Note: Variable spec listed below are dependant on system code selection. [Click here to see specific variations.](#)

- | | | |
|--|---|--------------------------------|
| <input type="checkbox"/> Black | <input type="checkbox"/> Polished Chrome | <input type="checkbox"/> White |
| <input type="checkbox"/> Bronze | <input type="checkbox"/> Silver or Aluminum | |
| <input type="checkbox"/> Champagne (Matted Gold) | | |

Special Note: *All fixtures and lighting systems must be used with dedicated circuit and a Prima transformer, driver, and/or ballast to comply with cUL/cETL listing; or all warranties are void.

SYSTEM CODE:	LUMEN STYLES:	FINISH COLORS:
(10) 120V ADAPTER FOR P-TRACK FIXTURE	Not Available	Not Available
(20) FIT SYSTEM	LD/00	BK/SV
(25) 120V RETRO-FIT ADAPTER FOR H-TRACK FIXTURE	Not Available	Not Available
(26) 120V RETRO-FIT ADAPTER FOR J-TRACK FIXTURE	Not Available	Not Available
(27) H-TRACK RETRO FIT ADAPTER	LD/00	BK/SV/WH
(28) J-TRACK RETRO FIT ADAPTER	LD/00	BK/SV/WH
(29) HOUSING ADAPTER FOR P-TRACK	LD/00	BK/SV/WH
(40) LOW VOLTAGE MONORAIL SYSTEM	LD/00	BK/SV/BZ/CP/PC
(42) CABLE SYSTEM – 6" WIDTH	LD/00	BK/SV/PC
(43) CABLE SYSTEM – 2.75" WIDTH	LD/00	BK/SV/PC
(E1) MONOPOINT 5" CANOPY W/ 120V TO 12V TRANSFORMER	00	BK/SV/BZ/PC/CP/WH
(E2) MONOPOINT 5" CANOPY W/ 277V TO 12V TRANSFORMER	00	BK/SV/BZ/PC/CP/WH
(E3) MONOPOINT 5" CANOPY W/ 120V BALLAST OR LED 120V/12V TRANSFORMER	LD	BK/SV/BZ/PC/CP/WH
(E4) MONOPOINT 5" CANOPY W/ 277V BALLAST OR LED 277V/12V TRANSFORMER	LD	BK/SV/BZ/CP/WH
(E5) MONOPOINT 5.5" CANOPY W/ DIMMABLE 120V~277V BALLAST	Not Available	Not Available
(E6) MONOPOINT 5.5" CANOPY W/ CONSTANT CURRENT DRIVER	Not Available	Not Available
(M1-M7) MULTIPOINT	(CONSULT FACTORY)	(CONSULT FACTORY)
(P1) MONOPOINT DIA. 0.7" W/ THREADED NIPPLE MOUNTING	LD/00	BK/SV/BZ/PC/CP/WH
(P2) MONOPOINT DIA. 1.6" W/ THREADED NIPPLE MOUNTING	LD/00	BK/SV/BZ/PC/CP/WH
(P3) MONOPOINT DIA. 1.6" W/ SCREW/ANCHOR MOUNTING	LD/00	BK/SV/BZ/PC/CP/WH
(P4) MONOPOINT 5" DIRECT MOUNT SQUARE COVER PLATE	LD/00	BK/SV/BZ/PC/CP/WH
(P5) MONOPOINT 5" JBOX PLATE	LD/00	BK/SV/BZ/PC/CP/WH

BCH9.8-A9BG-CBG5F9-B'A-@A9H9FG0B7<9GQ

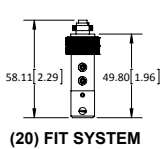

(20) FIT SYSTEM

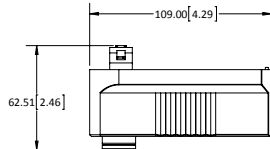

(27) H-TRACK ADAPTER

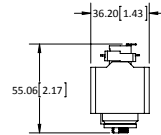

(28) J-TRACK ADAPTER

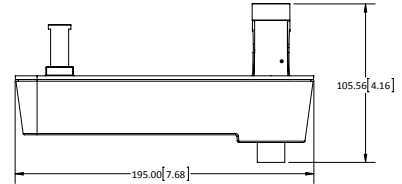

(29) HOUSING ADAPTER FOR P-TRACK

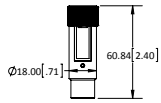

(40) LOW VOLTAGE MONORAIL SYSTEM

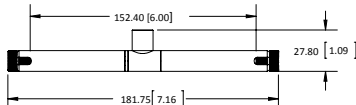

(42) CABLE SYSTEM - 6.00" WIDTH

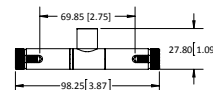

(43) CABLE SYSTEM - 2.75" WIDTH

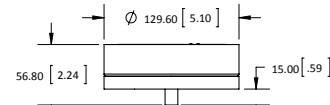

(E1) MONOPOINT 5" CANOPY W/ 120V TO 12V TRANSFORMER

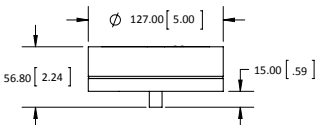

(E2) MONOPOINT 5" CANOPY W/ 277V TO 12V TRANSFORMER

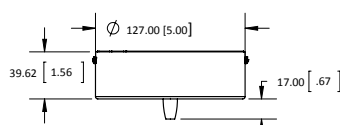

(E3) MONOPOINT 5" CANOPY W/ 120V BALLAST OR LED 120V/12V TRANSFORMER

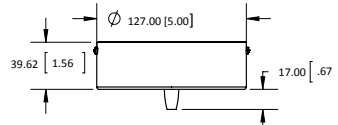

(E4) MONOPOINT 5" CANOPY W/ &+V BALLAST OR LED 277V/12V TRANSFORMER

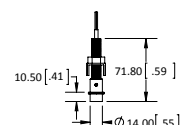

(P1) MONOPOINT DIA. 0.7" W/ THREADED NIPPLE MOUNTING

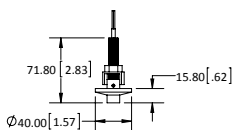

(P2) MONOPOINT DIA. 1.6" W/ THREADED NIPPLE MOUNTING

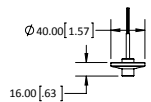

(P3) MONOPOINT DIA. 1.6" W/ SCREW/ANCHOR MOUNTING

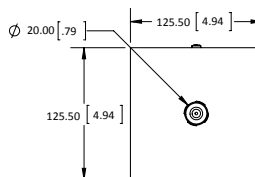

(P4) 5" DIRECT MOUNT SQUARE COVER PLATE

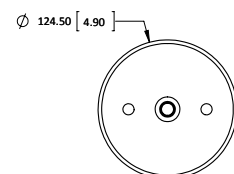

(P5) MONOPOINT 5" JBOX PLATE