

# AVELINA MEETING TABLES // DESIGNED BY MADSEN + CONTOIS

Please note that effective April 1st, 2025, a 4.5% tariff surcharge will be applied to the net subtotal on all orders.



## PRODUCT FEATURES:

- » Tables offered in veneer, laminate, Fenix and Formica Colorcore 2.
- » Corian top also available.
- » Tables with 20" depth are intended for use against a wall or divider (**signature edge detail featured on one side only**).

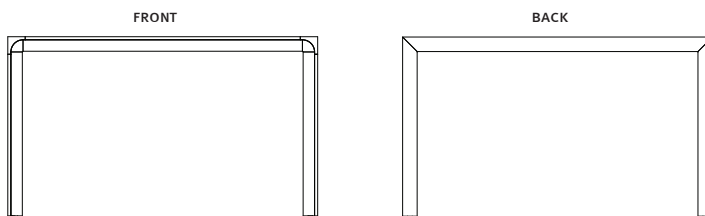

- » Table lengths of 120" and greater will require a center panel base.
- » All panel bases feature adjustable glides as standard for leveling purposes.
- » End panel bases, center panel bases and underside of tables feature removable panels for wire management accessibility.
- » Select technology options for top surface and/or side-mount placement available on all sizes, please refer to pages 6-10 for options. Power units cannot be installed on center panel bases.
- » Two-tone wood finishing available (exterior surface one color, interior surface another color), please add \$408 list for 1-piece tops and \$684 List for 2-piece tops and specify finishes. Edge finish will be the interior surface color.
- » All dimensions are nominal.

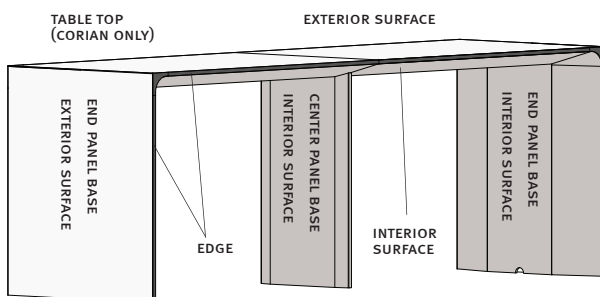

# AVELINA MEETING TABLES // DESIGNED BY MADSEN + CONTOIS



## veneER TABLE SPECIFICATIONS:

- » Available in maple, walnut and white oak wood species.
- » Veneer direction will run cross-grain on all table sizes.
- » All standard wood finishes available on selected wood species (note: MA0915 Ebony Maple not available).
- » Premium wood finish upcharge applies to the following wood finishes. Refer to options section for pricing.
  - Super Matte Sable Maple
  - Alabaster Oak
  - Super Matte Sable Oak
- » For custom wood finishes, please add one-time upcharge of \$472 List per color per order.

## LAMINATE TABLE SPECIFICATIONS:

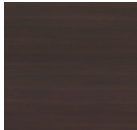
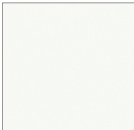

- » Applied to entire exterior surface only (cannot be used in combination with veneer exterior end panel bases).
- » Wood species and finish must be specified for the table interior surface, which will also be applied to the edge. For the best results, please reference guide below which identifies the appropriate wood species for each standard laminate.
- » Laminate wood grain direction will run lengthwise on all table sizes.
- » Available in all standard laminates.
- » Matching wood edges and/or bases specified with Formica Brite White and Pionite Slate, please add one-time upcharge of \$472 List per color, per order.
- » Matching wood edges and/or bases to our standard wood grain laminates is performed at no additional upcharge.
- » For custom laminates, add \$590 List per color per order. Pre-approval required, please contact client services.

## STANDARD LAMINATES AND CORRESPONDING WOOD SPECIES:

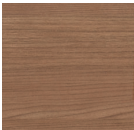
					<b>MAPLE</b>
Nevamar WM-8-340T Clear Maple	Nevamar WM-0005T Siren Maple	Pionite WX421-PV Witchcraft	Formica 459-58 Brite White	Pionite SG228-SD Slate	

	<b>WALNUT</b>
Wilsonart 7937-38 River Cherry	

					<b>WHITE OAK</b>
Wilsonart 7954-38 Natural Rift	Formica 5794-NG Beige Elm	Wilsonart 7937-38 River Cherry	Wilsonart 8212K-28 Phantom Ecru	Pionite WY160-SD Absolute Acajou	

		
Nevamar WM-0047T Iconic Maple	Pionite SW101-AW Black Ashwood	Wilsonart 1595-60 Black

# AVELINA MEETING TABLES // DESIGNED BY MADSEN + CONTOIS

## FENIX TABLE SPECIFICATIONS:

- » Applied to entire exterior surface only (cannot be used in combination with veneer exterior end panel bases).
- » Wood species and finish must be specified for the table interior surface, which will also be applied to the edge.
- » Matching wood edges and/or bases specified with Bianco Kos, please add one-time upcharge of \$472 List per order.
- » Matching wood edges and/or bases specified in Nero Ingo is performed at no additional upcharge. Finish will be super matte black on white oak species.

## FENIX COLORS:

- » FJ0032 Bianco Kos
- » FJ0718 Grigio Londra
- » FJ0720 Nero Ingo
- » FJ0724 Grigio Bromo
- » FJ0725 Grigio Efeso

## FORMICA COLORCORE 2 SPECIFICATIONS:

- » Features the same high performance characteristics as laminates with the added dimension of solid through color (i.e. eliminates the dark line associated with laminate edges).
- » Offered in 949C-58 White Matte color only.
- » Applied to entire exterior surface only (cannot be used in combination with veneer exterior end panel bases).
- » Wood species and finish must be specified for the table interior surface, which will also be applied to the edge.
- » To order in Colorcore 2, please specify and add \$421 list for 1-piece tops and \$699 List for 2-piece tops (add upcharge to applicable interior surface wood species column).

## CORIAN TOP SPECIFICATIONS:

- » Corian is affixed to table top only and increases overall table height by  $\frac{1}{2}$ ". Please note that a  $\frac{1}{8}$ " reveal will be present.
- » Corian not available on table edges or on panel bases.
- » Wood species and finish must be specified for panel bases.
- » For Corian top, specify "-CO" after model number with color selection and add upcharge to applicable table pricing.
- » Custom Corian colors available, please contact client services for pricing.

## CORIAN COLORS:

- » CWN Designer White
- » CLN Linen
- » CTD Witch Hazel
- » CRC Rain Cloud
- » CGQ Grey Onyx
- » CSQ Stonique

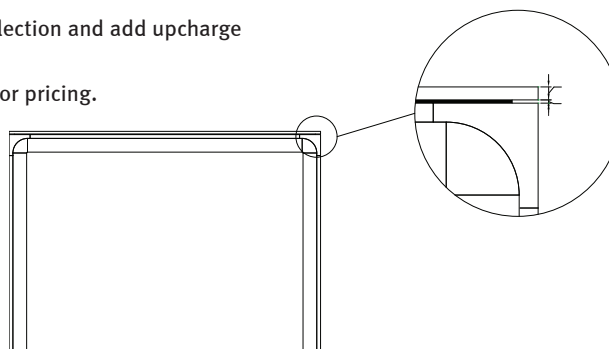

## SHIPPING/ASSEMBLY:

- » **All tables ship blanket-wrapped within the contiguous United States.**
- » If cartoning is required, a 20% upcharge will be applied to each applicable product. Contact client services for additional information.
- » Please note that Canadian shipments are unable to be shipped blanket-wrapped and a 20% cartoning surcharge will always apply.
- » Tables 96" in length and under ship in one piece.
- » Tables 120" in length and over ship in two sections.
- » All tables that are shipped in more than one piece will include a table joint connector to attach sections together.
- » Limited field assembly is required as bases are pre-assembled to table tops.

## ORDERING REQUIREMENTS:

- » Model number
- » Wood species
- » Exterior surface finish
- » Interior surface finish, as applicable
- » Options, as applicable

# AVELINA MEETING TABLES // DESIGNED BY MADSEN + CONTOIS

## ORDERING REQUIREMENTS:

- » Model number
- » Wood species
- » Exterior surface finish
- » Interior surface finish, as applicable
- » Options, as applicable

*Intended for use against a wall or divider	MODEL NUMBER	MAPLE OR LAMINATE EXTERIOR WITH MAPLE INTERIOR	WALNUT, WHITE OAK OR LAMINATE EXTERIOR WITH WALNUT OR WHITE OAK INTERIOR	FENIX EXTERIOR (-FE) Add upcharge to applicable wood species column	CORIAN TOP (-CO) Add upcharge to applicable wood species column	WEIGHT (excludes Corian)
<b>20" Depth*, 29" Height</b>						
20 D x 60 L x 29 H	A-206029	7730	8544	874	1848	142
20 D x 72 L x 29 H	A-207229	8039	8877	874	2217	151
20 D x 96 L x 29 H	A-209629	8524	9414	874	2952	165
20 D x 120 L x 29 H	A-2012029	10842	12024	1747	3690	256
20 D x 144 L x 29 H	A-2014429	11053	12218	1747	4426	269
20 D x 192 L x 29 H	A-2019229	11904	13094	1747	5899	289
<b>20" Depth*, 42" Height</b>						
20 D x 60 L x 42 H	A-206042	8039	8797	874	1848	153
20 D x 72 L x 42 H	A-207242	8342	9362	874	2217	163
20 D x 96 L x 42 H	A-209642	8833	9761	874	2952	177
20 D x 120 L x 42 H	A-2012042	11204	12368	1747	3690	287
20 D x 144 L x 42 H	A-2014442	11741	12960	1747	4426	301
20 D x 192 L x 42 H	A-2019242	12385	13795	1747	5899	321
<b>30" Depth, 29" Height</b>						
30 D x 60 L x 29 H	A-306029	9348	10581	1747	2767	156
30 D x 72 L x 29 H	A-307229	9702	10873	1747	3322	169
30 D x 96 L x 29 H	A-309629	10042	11409	1747	4426	183
30 D x 120 L x 29 H	A-3012029	12891	14546	2619	5534	280
30 D x 144 L x 29 H	A-3014429	13358	15136	2619	6638	198
30 D x 192 L x 29 H	A-3019229	14622	15753	2619	8848	318
<b>30" Depth, 42" Height</b>						
30 D x 60 L x 42 H	A-306042	9584	10878	1747	2767	193
30 D x 72 L x 42 H	A-307242	10052	11489	1747	3322	205
30 D x 96 L x 42 H	A-309642	10689	12187	1747	4426	221
30 D x 120 L x 42 H	A-3012042	13749	15402	2619	5534	347
30 D x 144 L x 42 H	A-3014442	13883	15619	2619	6638	364
30 D x 192 L x 42 H	A-3019242	14938	16787	2619	8848	388

OPTIONS						
-PFW06	Premium Wood Finish (96" Length and Under)			275		
-PFW07	Premium Wood Finish (120" Length and Over)			400		

# AVELINA MEETING TABLES // DESIGNED BY MADSEN + CONTOIS

## ORDERING REQUIREMENTS:

- » Model number
- » Wood species
- » Exterior surface finish
- » Interior surface finish, as applicable
- » Options, as applicable

	MODEL NUMBER	MAPLE OR LAMINATE EXTERIOR WITH MAPLE INTERIOR	WALNUT, WHITE OAK OR LAMINATE EXTERIOR WITH WALNUT OR WHITE OAK INTERIOR	FENIX EXTERIOR (-FE) Add upcharge to applicable wood species column	CORIAN TOP (-CO) Add upcharge to applicable wood species column	WEIGHT (excludes Corian)
<b>36" Depth, 29" Height</b>						
36 D x 60 L x 29 H	A-366029	9588	10726	1747	3813	176
36 D x 72 L x 29 H	A-367229	9969	11332	1747	4574	188
36 D x 96 L x 29 H	A-369629	10437	11834	1747	6099	204
36 D x 120 L x 29 H	A-3612029	13384	15077	2619	7620	315
36 D x 144 L x 29 H	A-3614429	14664	16668	2619	9142	332
36 D x 192 L x 29 H	A-3619229	15589	17353	2619	12189	356
<b>36" Depth, 42" Height</b>						
36 D x 60 L x 42 H	A-366042	9893	11085	1747	3813	193
36 D x 72 L x 42 H	A-367242	10231	11683	1747	4574	205
36 D x 96 L x 42 H	A-369642	10871	12366	1747	6099	222
36 D x 120 L x 42 H	A-3612042	14507	16398	2619	7620	357
36 D x 144 L x 42 H	A-3614442	15523	17180	2619	9142	373
36 D x 192 L x 42 H	A-3619242	16115	18041	2619	12189	398
<b>42" Depth, 29" Height</b>						
42 D x 60 L x 29 H	A-426029	9728	11078	1747	4458	184
42 D x 72 L x 29 H	A-427229	10285	11602	1747	5336	196
42 D x 96 L x 29 H	A-429629	10712	12167	1747	7113	210
42 D x 120 L x 29 H	A-4212029	14456	16331	2619	8891	334
42 D x 144 L x 29 H	A-4214429	15615	17279	2619	10665	352
42 D x 192 L x 29 H	A-4219229	16467	18579	2619	14220	371
<b>42" Depth, 42" Height</b>						
42 D x 60 L x 42 H	A-426042	10083	11548	1747	4458	201
42 D x 72 L x 42 H	A-427242	10628	12145	1747	5336	214
42 D x 96 L x 42 H	A-429642	11239	12432	1747	7113	230
42 D x 120 L x 42 H	A-4212042	15695	17780	2619	8891	377
42 D x 144 L x 42 H	A-4214442	16375	18694	2619	10665	395
42 D x 192 L x 42 H	A-4219242	17715	20069	2619	14220	418

## OPTIONS

-PFW06	Premium Wood Finish (96" Length and Under)	275
-PFW07	Premium Wood Finish (120" Length and Over)	400

# AVELINA MEETING TABLES // DESIGNED BY MADSEN + CONTOIS

## ELECTRICAL UNIT NOTES:

- » All units below are corded and available for top surface and/or side-mount placement. Refer to pages 8-9 for daisy chain options.
- » Power units cannot be positioned above center panel bases nor can they be installed onto center panel bases themselves.
- » Side-mount placement can be on inside or outside of end panel bases.
- » **Please specify if power unit is to be placed on table top, inside base panel or outside base panel.**
- » Cord length should be taken into account when specifying electrical placement.
- » **Power source location must be identified.**
- » Refer to page 10 for power unit standard locations.
- » End interior panel bases, center panel bases and underside of tables feature removable panels for wire management accessibility.
- » To add power cord exit to the exterior base panel, please specify "-PC02" and add \$98 List. For 20" depth tables, please note the base location as left or right, as facing.

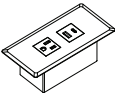
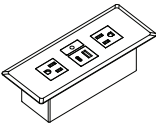
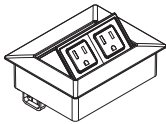
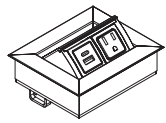
MODEL NUMBER	PRODUCT SPECIFICATIONS	LIST
<b>PX3-()</b> 	<b>Power Matrix 3</b> <ul style="list-style-type: none"> <li>» Dimensions: 5<sup>7</sup>/<sub>8</sub>" W x 2<sup>7</sup>/<sub>8</sub>" D</li> <li>» Black (-B) or white finish (-W)</li> <li>» One (1) outlet, one (1) USB-A and one (1) USB-C charging port</li> <li>» 120" electrical cord (only length available)</li> <li>» UL listed</li> </ul>	472
<b>PX4-()</b> 	<b>Power Matrix 4</b> <ul style="list-style-type: none"> <li>» Dimensions: 7<sup>1</sup>/<sub>4</sub>" W x 2<sup>7</sup>/<sub>8</sub>" D</li> <li>» Black (-B) or white finish (-W)</li> <li>» Two (2) outlets, one (1) USB-A and one (1) USB-C charging port</li> <li>» 120" electrical cord (only length available)</li> <li>» UL listed</li> </ul>	494
<b>PP2</b> 	<b>Portal Power 2</b> <ul style="list-style-type: none"> <li>» Dimensions: 5<sup>1</sup>/<sub>4</sub>" W x 4<sup>1</sup>/<sub>4</sub>" D</li> <li>» Touch latch lid with metallic silver finish</li> <li>» Unit features two (2) simplex outlets with 72" electrical cord</li> <li>» 120" length cord available, please specify and add \$38 List</li> <li>» UL listed</li> </ul>	670
<b>PP3</b> 	<b>Portal Power 3</b> <ul style="list-style-type: none"> <li>» Dimensions: 5<sup>1</sup>/<sub>4</sub>" W x 4<sup>1</sup>/<sub>4</sub>" D</li> <li>» Touch latch lid with metallic silver finish</li> <li>» One (1) outlet with 72" electrical cord, one (1) USB-A and one (1) USB-C charging port</li> <li>» 120" length cord available, please specify and add \$38 List</li> <li>» UL listed</li> </ul>	792

# AVELINA MEETING TABLES // DESIGNED BY MADSEN + CONTOIS

## ELECTRICAL UNIT NOTES:

- » All units below are corded and available for top surface placement only. Refer to pages 8-9 for daisy chain options.
- » Power units cannot be positioned above center panel bases.
- » Cord length should be taken into account when specifying electrical placement.
- » **Power source location must be identified.**
- » End interior panel bases, center panel bases and underside of tables feature removable panels for wire management accessibility.
- » To add power cord exit to the exterior base panel, please specify -"PC02" and add \$98 List. For 20" depth tables, please note the base location as left or right, as facing.

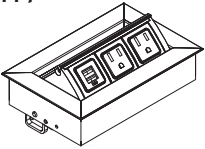
MODEL NUMBER	PRODUCT SPECIFICATIONS	LIST
<p><b>PP7</b></p> 	<p><b>Portal Power 7</b></p> <ul style="list-style-type: none"> <li>» Dimensions: 6<sup>3</sup>/<sub>4</sub>" W x 4<sup>3</sup>/<sub>8</sub>" D</li> <li>» Touch latch lid with clear anodized aluminum finish</li> <li>» Two (2) 15 amp simplex outlets, one (1) USB-A and one (1) USB-C charging port</li> <li>» 72" electrical cord</li> <li>» 120" length cord available, please specify and add \$38 List</li> <li>» UL listed</li> </ul> <p><b>PP7 units available for top surface mount placement only.</b></p>	<p>852</p>

# AVELINA MEETING TABLES // DESIGNED BY MADSEN + CONTOIS

## DAISY CHAIN ELECTRICAL UNIT NOTES:

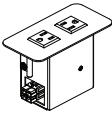
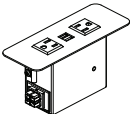
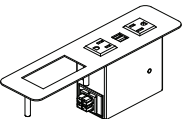
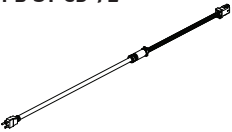
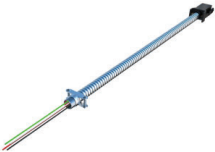

- » Daisy chain units are required when more than one electrical unit is specified on one top.
- » To determine jumper cable length, measure length from edge of electrical unit to end of table.
- » Every connection point must be a female-to-male or male-to-female connection **(all daisy chain power units feature male ends)**.

MODEL NUMBER	PRODUCT SPECIFICATIONS	LIST												
<b>PB2-DC-S (SILVER FINISH)</b> <b>PB2-DC-W (WHITE FINISH)</b> 	<b>Power Band 2 Daisy Chain</b> <ul style="list-style-type: none"> <li>» Dimensions: 5<sup>3</sup>/<sub>4</sub>" W x 2<sup>1</sup>/<sub>2</sub>" D</li> <li>» Metallic silver or white finish</li> <li>» Unit features two simplex outlets</li> <li>» UL listed</li> </ul>	428												
<b>PB3-DC-S (SILVER FINISH)</b> <b>PB3-DC-W (WHITE FINISH)</b> 	<b>Power Band 3 Daisy Chain</b> <ul style="list-style-type: none"> <li>» Dimensions: 6<sup>1</sup>/<sub>2</sub>" W x 2<sup>1</sup>/<sub>2</sub>" D</li> <li>» Metallic silver or white finish</li> <li>» Unit features two simplex outlets and two USB charging ports</li> <li>» UL listed</li> </ul>	640												
<b>PB4-DC-S (SILVER FINISH)</b> <b>PB4-DC-W (WHITE FINISH)</b> 	<b>Power Band 4 Daisy Chain</b> <ul style="list-style-type: none"> <li>» Dimensions: 10<sup>1</sup>/<sub>2</sub>" W x 2<sup>1</sup>/<sub>2</sub>" D</li> <li>» Metallic silver or white finish</li> <li>» Unit features two simplex outlets, two USB charging ports and cut-out for an A/V faceplate</li> <li>» For available A/V faceplate options, please contact client services</li> <li>» UL listed</li> </ul>	701												
<b>PB-ST-CD-72</b> 	<b>Power Band Starter Cable, 72" Long, Corded Plug Infeed</b> <ul style="list-style-type: none"> <li>» Must select either corded or hardwire starter cable which goes from power source in wall or floor to first power band unit</li> </ul>	276												
<b>PB-ST-HW-( )</b> 	<b>Power Band Starter Cable, Hardwire Infeed</b> <ul style="list-style-type: none"> <li>» Must select either corded or hardwire starter cable which goes from power source in wall or floor to first power band unit</li> </ul> <table border="1"> <thead> <tr> <th>MODEL</th> <th>LENGTH</th> <th>LIST</th> </tr> </thead> <tbody> <tr> <td>PB-ST-HW-72</td> <td>72"</td> <td>191</td> </tr> <tr> <td>PB-ST-HW-108</td> <td>108"</td> <td>220</td> </tr> <tr> <td>PB-ST-HW-120</td> <td>120"</td> <td>245</td> </tr> </tbody> </table>	MODEL	LENGTH	LIST	PB-ST-HW-72	72"	191	PB-ST-HW-108	108"	220	PB-ST-HW-120	120"	245	SEE TABLE
MODEL	LENGTH	LIST												
PB-ST-HW-72	72"	191												
PB-ST-HW-108	108"	220												
PB-ST-HW-120	120"	245												

# AVELINA MEETING TABLES // DESIGNED BY MADSEN + CONTOIS

## DAISY CHAIN ELECTRICAL UNIT NOTES:

- » Daisy chain units are required when more than one electrical unit is specified on one top.
- » To determine jumper cable length, measure length from edge of electrical unit to end of table.
- » Every connection point must be a female-to-male or male-to-female connection (**all daisy chain power units feature male ends**).

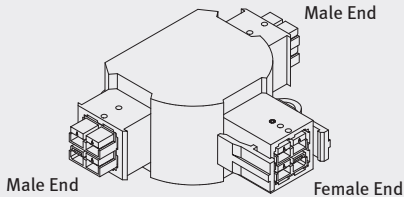
MODEL NUMBER	PRODUCT SPECIFICATIONS	LIST																											
<b>PB-FF-( )</b> 	<b>Power Band Jumper Cables, Female to Female</b> » Typically used to connect 2 units together » For additional lengths in 12" increments, please add \$21 List per foot  <table border="1"> <thead> <tr> <th>MODEL</th> <th>LENGTH</th> <th>LIST</th> </tr> </thead> <tbody> <tr><td>PB-FF-12</td><td>12"</td><td>130</td></tr> <tr><td>PB-FF-24</td><td>24"</td><td>142</td></tr> <tr><td>PB-FF-30</td><td>30"</td><td>154</td></tr> <tr><td>PB-FF-36</td><td>36"</td><td>154</td></tr> <tr><td>PB-FF-48</td><td>48"</td><td>166</td></tr> <tr><td>PB-FF-54</td><td>54"</td><td>172</td></tr> <tr><td>PB-FF-60</td><td>60"</td><td>179</td></tr> <tr><td>PB-FF-72</td><td>72"</td><td>191</td></tr> </tbody> </table>	MODEL	LENGTH	LIST	PB-FF-12	12"	130	PB-FF-24	24"	142	PB-FF-30	30"	154	PB-FF-36	36"	154	PB-FF-48	48"	166	PB-FF-54	54"	172	PB-FF-60	60"	179	PB-FF-72	72"	191	SEE TABLE
MODEL	LENGTH	LIST																											
PB-FF-12	12"	130																											
PB-FF-24	24"	142																											
PB-FF-30	30"	154																											
PB-FF-36	36"	154																											
PB-FF-48	48"	166																											
PB-FF-54	54"	172																											
PB-FF-60	60"	179																											
PB-FF-72	72"	191																											
<b>PB-FM-( )</b> 	<b>Power Band Jumper Cables, Female to Male</b> » Typically used to connect 2 units together » For additional lengths in 12" increments, please add \$21 List per foot  <table border="1"> <thead> <tr> <th>MODEL</th> <th>LENGTH</th> <th>LIST</th> </tr> </thead> <tbody> <tr><td>PB-FM-12</td><td>12"</td><td>130</td></tr> <tr><td>PB-FM-24</td><td>24"</td><td>142</td></tr> <tr><td>PB-FM-30</td><td>30"</td><td>154</td></tr> <tr><td>PB-FM-36</td><td>36"</td><td>154</td></tr> <tr><td>PB-FM-48</td><td>48"</td><td>166</td></tr> <tr><td>PB-FM-54</td><td>54"</td><td>172</td></tr> <tr><td>PB-FM-60</td><td>60"</td><td>179</td></tr> <tr><td>PB-FM-72</td><td>72"</td><td>191</td></tr> </tbody> </table>	MODEL	LENGTH	LIST	PB-FM-12	12"	130	PB-FM-24	24"	142	PB-FM-30	30"	154	PB-FM-36	36"	154	PB-FM-48	48"	166	PB-FM-54	54"	172	PB-FM-60	60"	179	PB-FM-72	72"	191	SEE TABLE
MODEL	LENGTH	LIST																											
PB-FM-12	12"	130																											
PB-FM-24	24"	142																											
PB-FM-30	30"	154																											
PB-FM-36	36"	154																											
PB-FM-48	48"	166																											
PB-FM-54	54"	172																											
PB-FM-60	60"	179																											
PB-FM-72	72"	191																											
<b>PB-T</b> 	<b>Power Band T-Connector</b> » Used when power is needed to go in two directions » Features 2 male ends and 1 female end  	172																											

# AVELINA MEETING TABLES // DESIGNED BY MADSEN + CONTOIS

POWER UNIT STANDARD LOCATIONS:

### Table Top Positioning

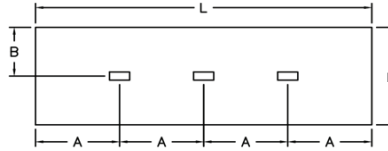
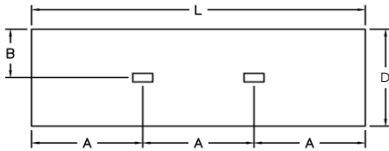

### Panel Base (inside & outside)

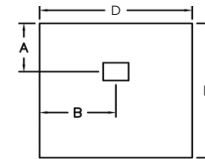

### 2 Power Units

D X L	A	B
20" x 60"	20"	5"
20" x 72"	24"	5"
20" x 96"	32"	5"
20" x 120"	40"	5"
20" x 144"	48"	5"
20" x 192"	64"	5"
30" x 60"	20"	15"
30" x 72"	24"	15"
30" x 96"	32"	15"
30" x 120"	40"	15"
30" x 144"	48"	15"
30" x 192"	64"	15"
36" x 60"	20"	18"
36" x 72"	24"	18"
36" x 96"	32"	18"
36" x 120"	40"	18"
36" x 144"	48"	18"
36" x 192"	64"	18"
42" x 60"	20"	21"
42" x 72"	24"	21"
42" x 96"	32"	21"
42" x 120"	40"	21"
42" x 144"	48"	21"
42" x 192"	64"	21"

### 3 Power Units

D X L	A	B
20" x 60"	15"	5"
20" x 72"	18"	5"
20" x 96"	24"	5"
30" x 60"	15"	15"
30" x 72"	18"	15"
30" x 96"	24"	15"
36" x 60"	15"	18"
36" x 72"	18"	18"
36" x 96"	24"	18"
42" x 60"	15"	21"
42" x 72"	18"	21"
42" x 96"	24"	21"

### 1 Power Unit

D X H	A	B
20" x 29"	10.25"	5"
30" x 29"	10.25"	15"
36" x 29"	10.25"	18"
42" x 29"	10.25"	21"
20" x 42"	10.25"	5"
30" x 42"	10.25"	15"
36" x 42"	10.25"	18"
42" x 42"	10.25"	21"

For custom power unit placement, please contact client services to verify location can be accommodated.