

Encore will determine best shipping method, whether blanket-wrapped or cartoned, based on unit quantity and destination. Please contact client services for additional information.

CROMO MULTIPURPOSE TABLES | Designed by CLAUDIO BELLINI Studio

Please note that effective April 1st, 2025, a 4.5% tariff surcharge will be applied to the net subtotal on all orders.



PRODUCT FEATURES:

- Flip-up and fixed top tables.
- Fixed tables available with glides or casters.
- Flip-up tables offered with casters only and feature a twist-and-release mechanism for quick and easy set-up and storage.
- All casters feature locking capability.
- Base tube diameter: 1.5".
- Ships KD. Assembly required.
- To ship fully assembled, set-up charge will be \$500 List per unit.
- Please note that Canadian shipments are unable to be shipped blanket-wrapped and a 20% cartoning surcharge will always apply.
- Optional power units available. Please refer to page 6 for options.
- All dimensions are nominal.
- Refer to terms and conditions for general information regarding finishes, warranty, freight, complete condition of sales and more.

SPECIFICATIONS:

- Table tops offered in White Oak and Walnut veneer as well as laminate and Fenix® selections.
- .75" top thickness.
- Premium wood finish upcharge applies to the following wood finishes. Refer to options section for pricing.
 - Alabaster Oak
 - Super Matte Sable Oak
- For custom wood finishes, please contact client services and add one-time upcharge of \$531 List per color per order.
- Laminate available in all standard colors.
- For custom laminate options, add \$649 List per color per order. Pre-approval required, please contact client services.
- Unless specified, veneer and laminate wood grain direction will run lengthwise on all top sizes.
- Fenix® offered in five standard colorways.
- For non-standard Fenix® colors, please contact client services for pricing.
- Metal base available in standard and premium finishes. See following page for options.
- For custom metal finish colors, please contact client services for pricing.

CROMO MULTIPURPOSE TABLES | Designed by CLAUDIO BELLINI Studio

TABLE EDGE SPECIFICATIONS:

- For veneer, edge finish will always match the top finish color, unless otherwise specified.
- For wood grain and solid black laminates, as well as Fenix® Nero Ingo (black), edge will match the top color, unless otherwise specified.
- For all other solid color laminates and Fenix®, edge finish will be natural (clear coat) as standard, unless otherwise specified.
- Edges are also available in all standard wood finishes, please specify. For custom edge finishes (e.g. to match standard solid color laminates), please add one-time upcharge of \$531 List per color, per order.

FENIX COLORS:

- Bianco Kos
- Nero Ingo
- Grigio Efeso
- Grigio Londra
- Grigio Bromo

STANDARD METAL BASE FINISHES:

- 0405 Charcoal Grey
- 0535 Metallic Silver
- 0630 Satin Black

PREMIUM METAL BASE FINISHES:

- 0605 Matte Black
- 0705 Matte Cotton
- 0788 Glossy Cotton
- 0805 Oasis
- 0905 Mint
- 1005 Mercury
- 1105 Canary
- 1205 Stone
- 1305 Sage
- 1405 Ice Blue
- 1505 Clay

CONNECTING TABLE MECHANISM FEATURES:

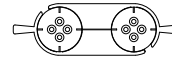
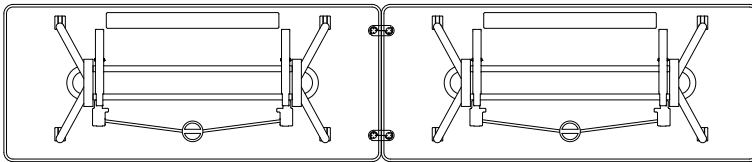

Ganging mechanism, locked
(2 units above are included per set).

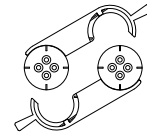

Ganging mechanism, unlocked.

- Ordered separately, ganging mechanism comes two per set to connect two tables together (end-to-end, side-to-side, end-to-side, etc.).
- **Please include layout drawings or sketch with each order to ensure proper ganging bracket placement location.**

MODESTY PANEL PRODUCT FEATURES:

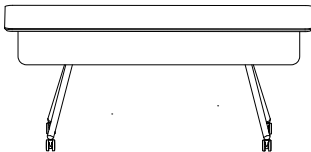

- 9.5" high x .5" thick panel available on flip-up tables with casters only.
- PET material, offered in Pewter as standard.
- In-field installation required.
- Attaches with provided velcro straps.

Encore will determine best shipping method, whether blanket-wrapped or cartoned, based on unit quantity and destination. Please contact client services for additional information.

CROMO MULTIPURPOSE TABLES | Designed by CLAUDIO BELLINI Studio

POWER UNITS:

- Available on all models and clamps onto edge of table-top.
- White finish with 72" or 120" electrical cord (no hardwire option available for this series).
- UL listed.
- Adjustable bands for vertical wire management included when power is specified.

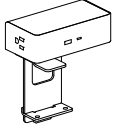

SPM
5" W x 3.5" D x 1.75" H
Two outlets, one USB-A and one USB-C charging port

DAISY CHAIN ELECTRICAL SPECIFICATIONS:

- Daisy chain units are required for end-to-end or ganging connections, as well as when two electrical units are specified on one top.
- To determine jumper cable length, measure length from edge of electrical unit to end of table.
- Ganging connectors are required for all daisy chain applications.
- Refer to page 7 for options and pricing.
- Note: Always disconnect cables prior to separating tables.

Encore will determine best shipping method, whether blanket-wrapped or cartoned, based on unit quantity and destination. Please contact client services for additional information.

CROMO MULTIPURPOSE TABLES | Designed by CLAUDIO BELLINI Studio

TABLE NESTING DIMENSIONS (BASED ON 72" TABLE LENGTH).

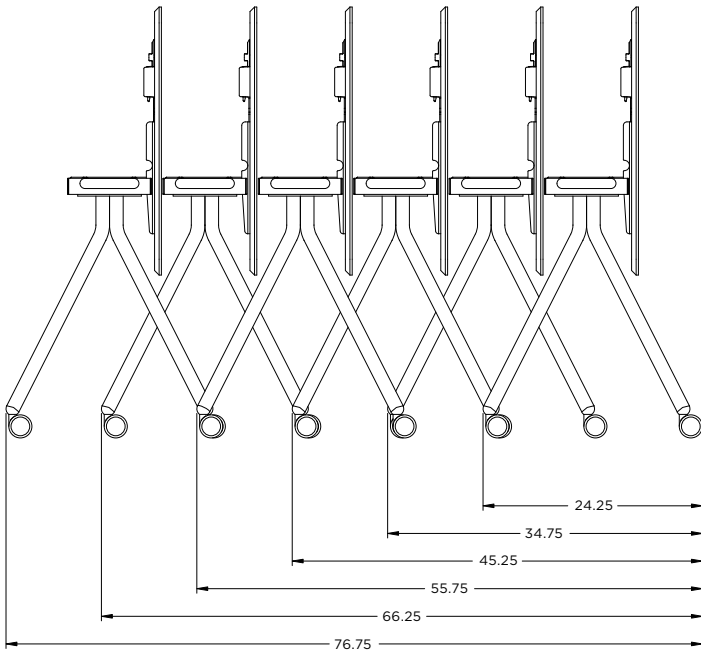
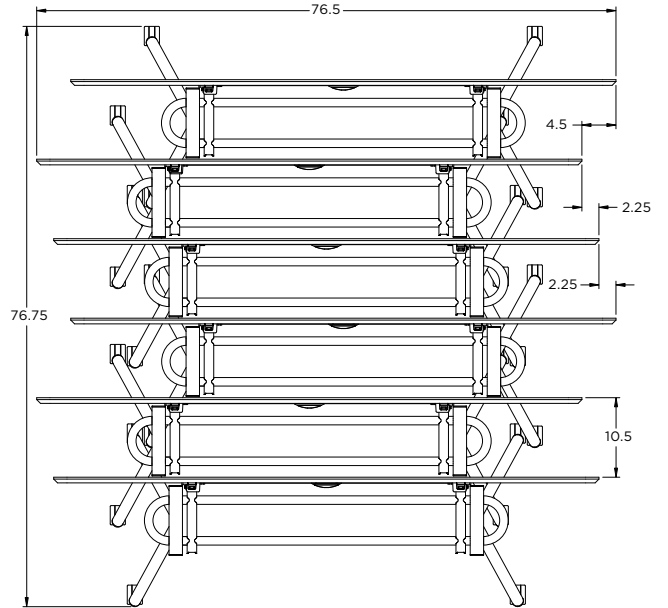
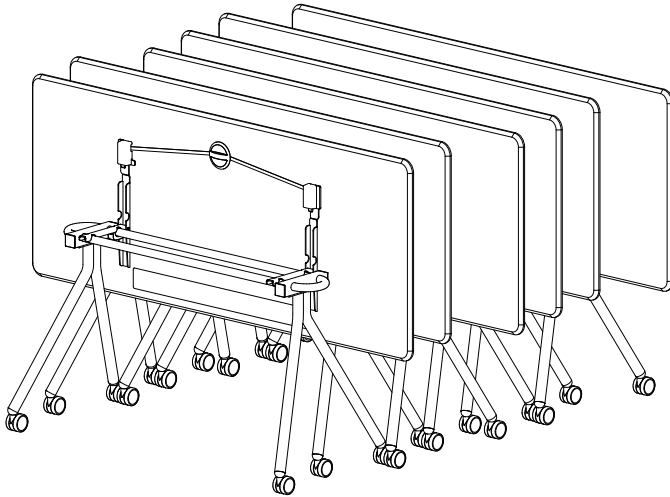





Encore will determine best shipping method, whether blanket-wrapped or cartoned, based on unit quantity and destination. Please contact client services for additional information.

CROMO MULTIPURPOSE TABLES | Designed by CLAUDIO BELLINI Studio

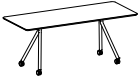
ORDERING REQUIREMENTS:

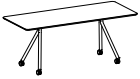
- Model number
- Surface material
- Surface finish
- Metal finish
- Options, as applicable

MODEL	DIMENSIONS	veneer (-V)	laminate (-L)	fenix (-FE)	weight
Flip-Up Top, Casters					
 9020-246029	24" D x 60" L x 29" H	3,648	3,398	3,859	66 lbs.
9020-247229	24" D x 72" L x 29" H	3,935	3,652	4,205	70 lbs.
 9020-306029	30" D x 60" L x 29" H	3,965	3,672	4,248	71 lbs.
9020-307229	30" D x 72" L x 29" H	4,282	3,946	4,637	77 lbs.
Fixed Top, Casters					
 9021-246029	24" D x 60" L x 29" H	3,008	2,759	3,220	66 lbs.
9021-247229	24" D x 72" L x 29" H	3,380	3,097	3,650	70 lbs.
9021-306029	30" D x 60" L x 29" H	3,325	3,033	3,609	71 lbs.
9021-307229	30" D x 72" L x 29" H	3,727	3,391	4,082	77 lbs.
Fixed Top, Glides					
 9022-246029	24" D x 60" L x 29" H	3,008	2,759	3,220	66 lbs.
9022-247229	24" D x 72" L x 29" H	3,380	3,097	3,650	70 lbs.
9022-306029	30" D x 60" L x 29" H	3,325	3,033	3,609	71 lbs.
9022-307229	30" D x 72" L x 29" H	3,727	3,391	4,082	77 lbs.

OPTIONS

-PFM02	Premium Metal Finish	\$101
-PFW06	Premium Wood Finish	\$311
GC11 (order separately)	Ganging Connector (per table joint)	\$70
MP54 (order separately)	54" Modesty Panel (for 60" L tables)*	\$304
MP66 (order separately)	66" Modesty Panel (for 72" L tables)*	\$400

*Note: Modesty panels are only available on flip-up tables with casters.

Encore will determine best shipping method, whether blanket-wrapped or cartoned, based on unit quantity and destination. Please contact client services for additional information.

CROMO MULTIPURPOSE TABLES | Designed by CLAUDIO BELLINI Studio

ORDERING REQUIREMENTS:

- Power unit model number should follow applicable table model number.

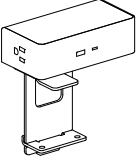
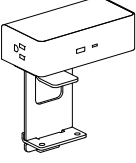

Note: No hardwire option available for this series.

MODEL	DESCRIPTION	LIST
SPM-72 	Surface Power Module 1 Dimensions: 5" W x 3.5" D x 1.75" H White finish Unit features two simplex outlets, one USB-A and one USB-C charging port 72" electrical cord UL listed	416
SPM-120 	Surface Power Module 2 Dimensions: 5" W x 3.5" D x 1.75" H White finish Unit features two simplex outlets, one USB-A and one USB-C charging port 120" electrical cord UL listed	416

Encore will determine best shipping method, whether blanket-wrapped or cartoned, based on unit quantity and destination. Please contact client services for additional information.

CROMO MULTIPURPOSE TABLES | Designed by CLAUDIO BELLINI Studio

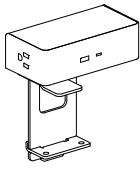
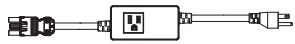
- Daisy chain units are required when more than one electrical unit is specified on one top.
- To determine jumper cable length, measure length from edge of electrical unit to end of table.

MODEL	DESCRIPTION	LIST												
SPM-DC 	Surface Power Module Daisy Chain <ul style="list-style-type: none"> ■ Dimensions: 5" W x 3.5" D x 1.75" H ■ White finish ■ Unit features two simplex outlets, one USB-A and one USB-C charging port ■ Includes splitter for connection with starter cable and jumper cables ■ UL listed 	512												
ST-DC 	Starter Cable, 124" Total Length <ul style="list-style-type: none"> ■ Corded plug infeed ■ Connects from power source in wall or floor to first Surface Power Module ■ Includes convenience outlet 	199												
JC-CD () 	Jumper Cables <ul style="list-style-type: none"> ■ Typically used to connect two (2) units together. <table border="1" data-bbox="532 1213 917 1507"> <thead> <tr> <th>MODEL</th> <th>LENGTH</th> <th>LIST</th> </tr> </thead> <tbody> <tr> <td>DC-CD-48</td> <td>48"</td> <td>121</td> </tr> <tr> <td>DC-CD-60</td> <td>60"</td> <td>129</td> </tr> <tr> <td>DC-CD-72</td> <td>72"</td> <td>136</td> </tr> </tbody> </table>	MODEL	LENGTH	LIST	DC-CD-48	48"	121	DC-CD-60	60"	129	DC-CD-72	72"	136	see table
MODEL	LENGTH	LIST												
DC-CD-48	48"	121												
DC-CD-60	60"	129												
DC-CD-72	72"	136												