



A WATTS Brand

# S19224PDCF, S19224DCF, S19224DCRPT

## Wall-Mount Halo™ Eye/Face Wash with Bowl Dust Cover

- Halo™ delivers the most effective eye/face washdown coverage and spray pattern
- Exceeds ANSI/ISEA Z358.1 Specifications
- Industry's only self-draining design – The Aquaduct™
- Separate supply and waste pipes – meets CEN and Plumbing Requirements
- Ergonomic hand activation eyewash paddle – easy to reach from any direction
- Barrier free
- Fully-assembled and factory-tested eyewash or eye/face wash with hinged dust covers
- Universal identification sign and inspection tag included
- Classified by Underwriters Laboratories Inc. to ANSI/ISEA Z358.1.

### Specifications

Standard eye/face wash units save space and fit easily into any work environment. Halo eye/face wash, operated by an ergonomic, highly visible push handle, provides effective wash down coverage and spray pattern. Integral strainer reduces debris in the water and also prevents clogging.

This plumbing fixture is not intended to dispense water for human consumption through drinking or for preparation of food or beverages.

#### Pipe and Fittings

Piping to ½" NPT water supply inlet on unit. Piping to 1¼" NPT drain outlet for eyewash.

1¼" piping assembly manufactured of one of the following materials:

- Galvanized steel with BradTect® safety yellow coating

#### Ball Valve

½" stay-open eye and eye/face wash valve manufactured of the following materials:

- Chrome-plated brass

#### Eye/Face Wash

The Halo eye/face wash system offers a high performance rinsing platform that provides rapid relief to an individual's eyes and face that have been injured by chemicals or particulate. This system provides the most complete face wash available in the market. The eye/face wash includes an integral 5.1 gpm (19.2 L) flow control, providing water at a safe velocity while maintaining its effectiveness (exceeds minimum water flow of 3.0 gpm (11.4 L) at 30 PSI (2.0 bar)). Eye/face wash is protected by flip open dust covers that open when product is activated or by a full bowl dust cover that activates the unit when it is opened. Safe, steady water flow under varying water supply conditions from 30–90 PSI (2.0–6.1 bar) is assured by integral flow control in the sprayhead assembly. Sprayheads are made from an impact resistant ABS plastic.

#### Activation

Type 304 stainless steel push handle.

#### Bowl

Bowl is constructed of yellow impact-resistant plastic (S19224PDCF) or Type 304 corrosion resistant stainless steel (S19224DCF, S19224DCRPT).

#### Bowl Dust Cover

Dust cover is constructed of yellow impact-resistant plastic (S19224PDCF) or Type 304 corrosion resistant stainless steel (S19224DCF, S19224DCRPT).



#### Wall Bracket

Heavy-gauge sand cast aluminum protected with BradTect safety yellow coating. Includes three clearance holes for mounting bracket onto wall (mounting hardware not included).

#### Waste

1¼" drain fitting furnished. Chrome-plated tailpiece and P-trap included with S19224DCRPT.

Model	Description
S19224PDCF	Halo Eye/Face Wash, Plastic Bowl w/ Dust Cover
S19224DCF	Halo Eye/Face Wash, Stainless Steel Bowl & Hinged Dust Cover
S19224DCRPT	Halo Eye/Face Wash, Stainless Steel Bowl & Hinged Dust Cover, P-Trap

### Tepid Water Options

[Navigator S19-2000 EFX8  
Emergency Thermostatic Mixing Valve](#)

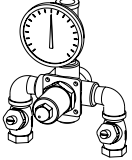

[Keltech CLE-Series  
Tankless Water Heater](#)

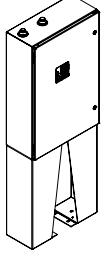

**NAVIGATOR**

Satisfies ANSI/ISEA Z358.1 tepid water requirements.



# S19224PDCFW, S19224DCFW, S19224DCRPT

## Wall-Mount Halo™ Eye/Face Wash with Bowl Dust Cover

### S19224 shown with Eye/Face Wash and Bowl Dust Cover

 Drawing depicts Eyewash. Eye/Face Wash dimensions are the same.

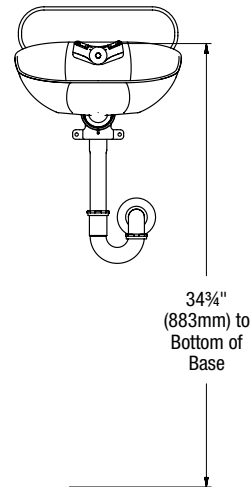
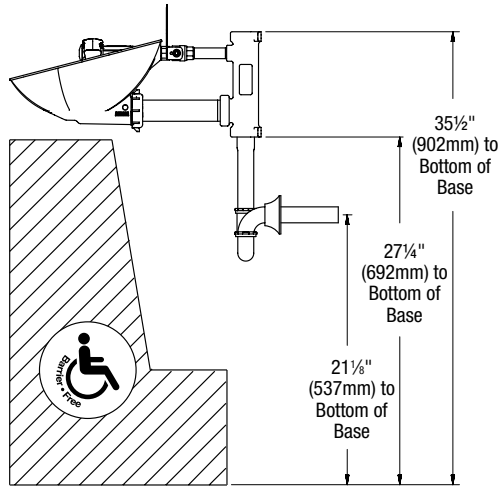

Eye/Face Wash Bowl

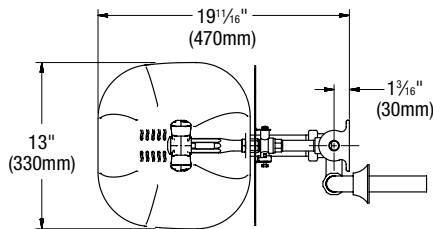

Dust Cover

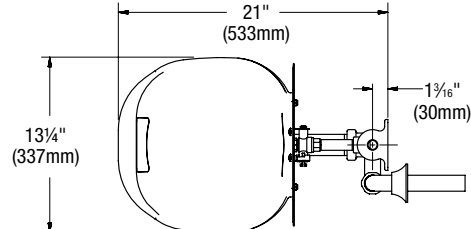

 All dimensions assume standard thread engagement. Variations in manufacturing allow for +/- 1/8" (3mm) per threaded joint. To find the tolerance of a dimension, add the number of thread joints across the length of the dimension and multiply it by 1/8" (3mm).