

# SitOnIt • Seating®

**Work From Home Price List** February 23, 2026



# TABLE OF CONTENTS

Warranty ..... 2  
Ordering Information ..... 4  
Shipping Information ..... 5  
Novo ..... 6  
Wit ..... 9  
Reya ..... 12  
Switchback..... 14  
Accessories ..... 16  
Care and Cleaning..... 17  
Laminate Care and Cleaning ..... 19  
Fabric and Finishes ..... 20

# SitOnIt • Seating®

## CALIFORNIA BORN AND BRED

We're a leading manufacturer of commercial solutions in the U.S.—and #1 in task chairs. From tables and lounge to screens and more, we've been the go-to destination for comprehensive, build-to-order solutions for almost 25 years.

We combine award-winning design with the fastest lead times around (choose from 2-, 5- or 10-day shipping). We can build almost any specification you want, deliver it when you need it and offer a price no one can match. It's all part of our indie California spirit and drive to help you do more.

### DESIGN THAT GETS YOU

Discover seating engineered around you. Experience responsive design, supreme comfort and hyper-customizable features—all at value-driven prices.

### OUR BUILD-TO-ORDER PROMISE

Custom-designed chairs, no waiting. Our nimble size and lean manufacturing operation means we can ship build-to-order chairs in just two days.

### FASTEST SHIPPING IN THE INDUSTRY

Choose from two, five, or 10 day shipping. We cut lead time, sync orders and avoid off-schedule shipments at a rate our competitors just can't match.

### WORLD-CLASS SERVICE

We're proud to announce that the Office Furniture Dealer Alliance voted for us as "Best Customer Service" three times in the past five years.

# WARRANTY

## Product Warranty Periods

The following warranty terms apply to SitOnIt Seating Home Edition products. Exemplis LLC, d.b.a. SitOnIt Seating (hereafter referred to as the Company), warrants to the original end user that this product will be free from defects in its material and workmanship when used in a single shift (standard eight-hour day, five days per week) for the following warranty periods:

### FIVE-YEAR WARRANTY COVERAGE:

- Wit – Home Edition
- Novo – Home Edition
- Reya – Home Edition
- Switchback<sup>1</sup> – Home Edition
- Mobile Pedestal<sup>2</sup> – Home Edition
- EON<sup>3</sup> – Home Edition
- High Tide 4 – Home Edition
- Mobio<sup>4</sup> – Home Edition
- Cable Caddy Basket – Home Edition
- Power Strip – Home Edition
- Laminate Tabletop

1. *Please note that power components on a height-adjustable table include: hand controls, motors, control boxes, and electrical cables.*
2. *This warranty does not cover damage from ordinary wear and tear, including paint finish changes and/ or discoloration resulting from aging or exposure to light.*
3. *Power components are defined as any power unit with electrical outlets and/ or USB/Data connections, connector jumper cables for daisy chain and infeed's for hardwire applications.*
4. *Weight capacity of the arms must be followed. If an arm is not functioning properly because of the weight of the monitor is outside of the advertised weight capacity, the monitor arm will not be considered defective under the warranty.*

## Freight Warranty

At SitOnIt Seating®, we take pride in crafting one-of-a-kind pieces. Products are thoughtfully inspected prior to being carefully wrapped and packed for shipment. Upon receiving your order, should your order be less than perfect, please follow these steps for an expedited resolution:

### IF DAMAGE IS VISIBLE:

1. Please accept shipment and report damages on the freight bill.
2. Contact SitOnIt Seating Customer Experience to report the issue **within 10 days after delivery.**

### IF DAMAGE IS CONCEALED:

1. Save merchandise and packaging.
2. Take a photo to document the damage.
3. Contact SitOnIt Seating Customer Experience **within 60 days after delivery.**

Either way, we are here to help! SitOnIt Seating Customer Experience Team is on standby to assist Monday through Friday, 5:00 a.m. to 5:00 p.m. PST. Call 866-764-4111 or email [shopcx@sitonit.net](mailto:shopcx@sitonit.net)

# WARRANTY

## The Company Does Not Warranty

- Product abuse or misuse
- Failure resulting from normal wear and tear
- User modification of or attachments to the product
- Products or parts not used, maintained or installed in accordance with the Company's installation, maintenance and/or applicable guidelines
- Products that are exposed to extreme environmental conditions and/or have been subject to improper storage
- Floor samples or display models
- Products purchased "as is" and/or secondhand
- The substitution or use of non-SitOnIt Seating components with SitOnIt Seating products
- Products sold by unauthorized dealers
- Creasing and/or gathering of textiles during upholstery application process
- Minor irregularities of color, surface, grain and texture
- Minor variations of color in textiles
- Variations of texture and natural markings such as neck wrinkles, scratches, backbone marks and stretch marks in leather
- Color matching of textiles exactly to samples, swatches or prior purchases

## Applicable Provisions To All Products And Services

Exemplis LLC and SitOnIt Seating (hereafter referred to as the Company), warrants to the original end user that this product will be free from defects in its material and workmanship when used in a single shift (standard 8-hour day, 5 days per week) for the above listed warranty periods: The Company will, at its option, repair or replace with a comparable product, without charge to the original purchaser, only defective products or parts found defective during the Warranty Period. If requested by the Company, the original purchaser must return the part or product with freight or other shipping charges prepaid.

Under no circumstances will the Company be liable for injuries or damages arising from use of the product.

This warranty shall be effective for the applicable time period beginning from date of purchase as shown on original purchaser's original receipt or other proof of purchase.

This is an EXCLUSIVE LIMITED WARRANTY.

There are no other warranties, expressed or implied, including without limitation, any implied warranty of merchantability or fitness for a particular purpose. The Company will not be responsible for incidental or consequential, special, or indirect damages. The purchaser is responsible for determining suitability for its intended use. The Company disclaims any liability for defects, loss of use, or claims or injuries arising out of the incorrect choice of product for particular usage. Some states do not allow the exclusion or limitation of incidental or consequential damages, so the above limitations or exclusions may not apply to you. This warranty gives you specific legal rights and you may have other rights which vary from state to state

The Company will advise you of the procedure to follow when making warranty claims. Call the Company at the number below to explain the defect. Give your name, address, and telephone number. Please be prepared with the model number and sales order number.

**SitOnIt Seating: (866) 764-4111**

# ORDERING INFORMATION

## Pricing

All prices are suggested retail and are subject to change without notice. Visit our websites or contact Customer Experience for the latest pricing. Prices in effect at the time of shipment will prevail. We reserve the right to make changes in prices, models, fabrics, finishes, materials and specifications and also discontinue models and options at any time without notice.

## Orders

Specify model number, quantity, desired delivery date and all other applicable information. Order templates can be found in the applicable Price Guide. Orders will be accepted with an acknowledgment form governing the transaction. In the event an error is made in the manufacture of the product, the acknowledgment will be used as the resolution document. Submit orders by email or fax:

### SITONIT SEATING

Email: [shopcx@sitonit.net](mailto:shopcx@sitonit.net)

Fax: (714) 995-4855

## Change Orders

Orders that have been scheduled for production may not be changed. All changes on customer orders previously acknowledged must be requested in writing and are subject to approval. Requests for changes are not deemed accepted until acknowledged. In the event a revision is accepted, change fees may apply.

## Lead Time

All "Home Edition" products have a two day manufacturing lead time.

Orders received by 10 a.m. Pacific Standard Time begin assembly the next day. Orders that are "On Hold" will begin production only when all holds are released. Types of holds include:

- Credit Hold for issues related to billing and invoicing.
- Incomplete Hold if the purchase order is incomplete or illegible.
- Pricing Hold if the price on the purchase order does not match the pricing shown in the Price Guide or in our computer system.

Customer Experience will notify you of any holds placed on your order.

## Product and Design Changes

We reserve the right to discontinue product lines, models and parts at any time. We also reserve the right to make changes in design and material when such action is deemed to be an improvement in design, function and/or construction.

## Cancellation and Returns

For Home Edition products, returns will be accepted within 30 days of purchase and are subject to a 20% restocking fee. Customer must receive an authorization to return the product, provide original order number and items must be shipped and received in new condition in original packaging. Customer is responsible for cost of return shipping.

Authorization for return must be requested from and be approved by Customer Experience prior to the return of the merchandise.

To request authorization contact Customer Experience by phone at (866) 764-4111 or by email [shopcx@sitonit.net](mailto:shopcx@sitonit.net).

Please allow a minimum of thirty days for SitOnIt Seating to process returned products after they have been received and a minimum of two billing cycles for refunds to be processed to credit cards, less the 20% restocking fee.

## Shipping

Shipments are made via standard residential delivery services based on our published transit times, unless otherwise specified. Special routing requests made by the customer or the consignee may result in additional charges.

We will not be held responsible for issues or costs arising from carrier transit delays, missed delivery appointments, etc.

Optional White Glove delivery service for product assembly is available for an additional fee. Please contact Customer Experience.

## Freight Terms

Freight terms apply to the continental U.S. only. This excludes Alaska and Hawaii. All standard transportation services and freight costs are included in the price of our products.

## Freight Damage

We are not responsible for product damage occurring in transit or during storage. Before accepting a shipment from the carrier, carefully review the packing list and inspect the quantity and condition of the items. Promptly document all visible damage on the and request a carrier inspection of the product. In the event of damage, accept the delivery and contact Customer Experience for issue resolution. Concealed damage must be reported in writing within 15 days of accepting delivery. We will take all reasonable steps to assist customers in resolving claims for loss or damage.

## Invoicing

Invoicing is triggered when the product ships.

# Novo

## HOME EDITION TASK CHAIR

*Hyper-customizable.  
Super-ergonomic.*

Modern and made to be the best seat in your house. Novo delivers a “corner office” experience with superior ergonomics, comfort-first design and easy adjustment options for making it look and feel almost any way you want.



reddot design award  
winner 2017



EFFECTIVE FEBRUARY 23, 2026

### Featured Models

#### **GOOD :: \$623**

Midback mesh, black frame, standard synchro mechanism, armless, grade 1 textile

#### **BETTER :: \$705**

Highback mesh, black frame, standard synchro mechanism, height-adjustable arms, grade 1 textile



#### **BEST :: \$797**

Highback mesh, white frame, standard synchro mechanism with seat-depth adjustment, height-adjustable arms, grade 1 textile

## Features

- Clean lines and subtly rounded corners give a contemporary aesthetic
- Midback and highback with adjustable lumbar support
- Multiple frame and fabric color choices to coordinate with your home
- Waterfall seat provides long-lasting comfort
- Synchronized mechanism and armless or height-adjustable arms
- Hard floor and carpet casters
- Standard 300 lb weight capacity warranty

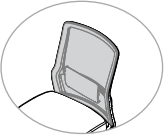
### 1. Back

Back Style	Code	Price	
Midback Mesh With Adjustable Lumbar Support	H1033 BK1 MB	\$623	
Highback Mesh With Adjustable Lumbar Support	H1033 BK2 MB	\$664	

Mesh Color	Code	Price	
Apple	MC31	+ \$0	
Desert	MC22	+ \$0	
Electric Blue	MC24	+ \$0	
Fire	MC25	+ \$0	
Fog	MC23	+ \$0	
Nickel	MC21	+ \$0	
Onyx	MC20	+ \$0	
Tangerine	MC28	+ \$0	

## HOME EDITION TASK CHAIR

### 2. Seat

Seat Style	Code	Price	
Upholstered Seat	US	+ \$0	

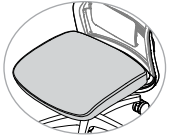
Seat Textile	Code	Price	
Grade 1 Fabric/Vinyl	FG1/VG1	+ \$0	

*Upholstery options are restricted to the 20 textiles that are available in the WFH program. For laminate swatches see Fabric and Finishes on page 17.*

### 3. Mechanism

Mechanism Style	Code	Price	
Standard Synchro	F	+ \$0	
Standard Synchro With Seat-Depth Adjustment	F/E3	+ \$63	

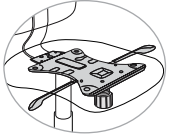
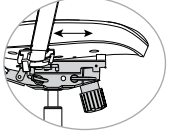
### 4. Frame and Lumbar

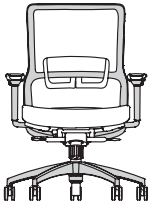
Frame and Lumbar Support Pad Color	Code	Price	
Black	FC1	+ \$0	
White	FC12	+ \$41	

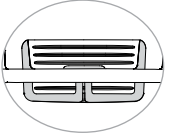

Adjustable Lumbar Color	Code	Price	
Black (For Black Frame FC1)	AL1	+ \$0	
White (For White Frame FC12)	AL2	+ \$0	

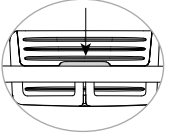

Lumbar Accent Color	Code	Price	
Black (For Black Frame FC1)	LA1	+ \$0	
White (For White Frame FC12)	LA13	+ \$0	

## 5. Arms

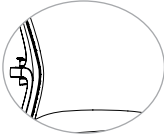
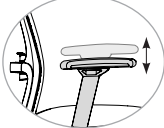
Arm Style	Code	Price	
Armless	AR0	+ \$0	
Height-Adjustable	AR4	+ \$41	

## 6. Base

Base Style	Code	Price	
5-Star Nylon	BT1	+ \$0	

Base Color	Code	Price	
Black (For Black Frame FC1)	BC1	+ \$0	
White (For White Frame FC12)	BC3	+ \$0	

Cylinder Height	Code	Price	
Standard Cylinder	CH1	+ \$0	

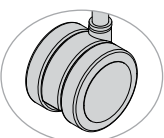
Casters	Code	Price	
Hard Floor and Carpet Casters	CS6	+ \$0	

## 7. Packaging

Packaging	Code	Price	
Knocked Down	KD	+ \$0	

## HOME EDITION TASK CHAIR

### SPECIFICATIONS

	1033.BK1 Midback Task Chair	1033.BK2 Highback Task Chair
Overall Width Armless	26"	26"
Overall Width With Arms	26"	26"
Overall Depth	26"	26"
Overall Height	36"	39"
Seat Width	20"	20"
Seat Depth	16.5"-18.5"	16.5"-18.5"
Seat Height	16.75"-20.25" (F) 17"-20.625" (F/E3)	16.75"-20.25" (F) 17"-20.625" (F/E3)
Back Width	19"	19"
Back Height	20"	23"
Weight Armless	31 lb	32 lb
Weight With Arms	37 lb	38 lb
Weight Capacity Warranty	300 lb	300 lb

Standard synchro mechanism (F). Seat-depth adjustment (E3).



Better

# Reya

## HOME EDITION DESK

### *The desk for everyone.*

Official business or family business, Reya provides a dedicated place to work when you're home. Rounded corners and slim, modern design fit in almost any room. Its patent-pending, lightning-fast assembly means you're ready to roll in about the time it takes to reheat those leftovers—no tools or teams required. Escape the clutter (and kitchen table) with a customizable look and feel for any home office.



20" x 40"



EFFECTIVE FEBRUARY 23, 2026

## Featured Models

**20" x 40" :: \$835**

20" x 40" table top, metal angled legs

**24" x 48" :: \$918**

24" x 48" table top, straight bamboo legs

**27" x 54" :: \$961**

27" x 54" table top, angled tapered bamboo legs

### Features

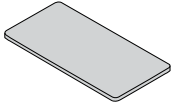

- With free residential delivery and easy assembly, Reya is a solution designed for everyone
- Our patent-pending design means you can go from box to work in 60 seconds—no tools needed
- Modern, light-scale design and selection of sizes, legs and finishes match any room in the house
- Rounded corners ensure only its looks are sharp, making it safe for hips and kids (and hip kids)
- Leveling glides ensure a stable table for any floor
- Every Reya includes a simple way to manage wires
- 200 lb weight capacity warranty

### 1. Tabletop

Product Type	Code	Price	
Reya – Home Edition	H3250	Priced by Size	
Tabletop Size	Code	Price	
<b>Rectangular Top With Rounded Corners</b>			
20" x 40"	TC2040	\$835	
24" x 48"	TC2448	\$877	
27" x 54"	TC2754	\$920	
Tabletop Material	Code	Price	
<b>Laminate</b>			
Black	TL19	+ \$0	
Cabinet Maple	TL21	+ \$0	
Folkstone	TL24	+ \$0	
Sandalwood	TL27	+ \$0	
Walnut Amati	TL28	+ \$0	
White	TL29	+ \$0	
<b>Bamboo</b>			
Clear Finish With Knife Edge	TL30	+ \$125	

For laminate swatches see Fabric and Finishes on page 17.

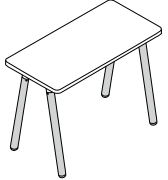
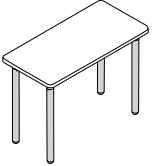
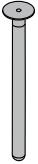
### 2. Table Base

Base Style	Code	Price	
Angled Legs	APL	+ \$0	
Straight Legs	SPL	+ \$0	
Base Material	Code	Price	
Metal	LS21	+ \$0	
Bamboo	LS23	+ \$41	
Tapered Bamboo	LS22	+ \$41	
Base Finish	Code	Price	
Black	BF03	+ \$0	
White	BF02	+ \$0	

On bamboo base, paint color will apply to the metal collar only.

# Switchback

HOME EDITION HEIGHT-ADJUSTABLE DESK

*Find your fit.*

Stand or sit, mix it up with the press of a button. Switchback® height-adjustable desk elevates the way you work from home—while maximizing ergonomics and minimizing fatigue.



EFFECTIVE FEBRUARY 23, 2026

## Featured Models

**24" × 42" :: \$1,242**

24" × 42" laminate tabletop and 2-leg 2-stage height-adjustable base

**24" × 48" :: \$1,274**

24" × 48" laminate tabletop and 2-leg 2-stage height-adjustable base

**27" × 54" :: \$1,463**

27" × 54" bamboo tabletop with knife edge and 2-leg 2-stage height-adjustable base

## HOME EDITION HEIGHT-ADJUSTABLE DESK

### Features

- Push-button controls with four user-customized positions
- Anti-collision sensor and digital lock ensure safety at home
- Quick and easy assembly in 10 minutes or less
- Six durable laminates, including eco-friendly bamboo, feature perfectly rounded corners
- Two durable powder-coated metal finishes in black or white
- With a height range of 28"-47" inches (including 0.75" top), anyone can find their ideal position
- 220 lb weight capacity warranty

### 1. Tabletop

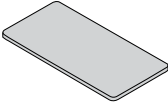
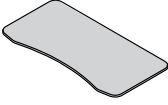
Product Type	Code	Price	
Switchback – Home Edition Tabletop	H3160	Priced by Size	
Tabletop Style	Code	Price	
T-Style 2-Leg	TBT5	Priced by Size	
Table Top Size (D x W)	Code	Price	
<b>Rectangular</b>			
24" x 42"	TC2442	\$1,242	
24" x 48"	TC2448	\$1,274	
27" x 54"	TC2754	\$1,338	
<b>Concave</b>			
24" x 48"	TD2448	\$1,341	
27" x 54"	TD2754	\$1,406	
Tabletop Material	Code	Price	
<b>Laminate</b>			
Black	TL19	+ \$0	
Cabinet Maple	TL21	+ \$0	
Folkstone	TL24	+ \$0	
Sandalwood	TL27	+ \$0	
Walnut Amati	TL28	+ \$0	
White	TL29	+ \$0	
<b>Bamboo</b>			
Clear Finish With Knife Edge	TL30	+ \$125	

*For laminate swatches see Fabric and Finishes. Concave tops are not available in bamboo (TL30). 24" x 42" tabletops (TC2442) are not available in bamboo.*

### 2. Base

Base Finish	Code	Price	
Silver	BF01	+ \$0	
White	BF02	+ \$0	
Black	BF03	+ \$0	

# Wit

## HOME EDITION TASK CHAIR

### *Work smarter.*

Discover a blueprint for coziness and our in-style solution for working at home. Wit® helps you zoom through meetings all day long with a look and feel that won Gold for Design Excellence at the ADEX Awards—one of the largest and most prestigious awards programs for product design.



*Best*

**EFFECTIVE FEBRUARY 23, 2026**

### Featured Models

#### **GOOD :: \$573**

Midback mesh back, upholstered seat, armless, swivel-tilt mechanism, black frame and base

#### **BETTER :: \$655**

Highback mesh back, upholstered seat, height-adjustable arms, swivel-tilt mechanism, black frame and base

#### **BEST :: \$781**

Highback mesh back, upholstered seat, height-adjustable arms, standard synchro mechanism with seat-depth adjustment, white frame and base

## Features

- Built-in pull handle makes it easy to grab-and-go (to work)
- Midback and highback options with adjustable lumbar support
- Multiple frame and fabric color choices to coordinate with your home
- Slim yet plush dual-density waterfall seat
- Swivel-tilt mechanism and armless or height-adjustable arms
- Hard floor and carpet casters
- Standard 300 lb weight capacity warranty

### 1. Back

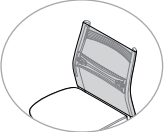
Back Style	Code	Price	
Midback Mesh With Adjustable Lumbar Support	H2222 MB	\$573	

Highback Mesh With Adjustable Lumbar Support	H2223 MB	\$614	
--	----------	-------	---

Mesh Color	Code	Price	
Fog Woven Striped	MC37	+ \$0	
Onyx Woven Striped	MC35	+ \$0	
Apple	MC31	+ \$0	
Desert	MC22	+ \$0	
Electric Blue	MC24	+ \$0	
Fire	MC25	+ \$0	
Fog	MC23	+ \$0	
Nickel	MC21	+ \$0	
Onyx	MC20	+ \$0	
Tangerine	MC28	+ \$0	

## HOME EDITION TASK CHAIR

### 2. Seat

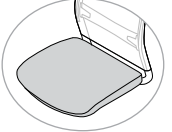
Seat Style	Code	Price	
Upholstered Seat	US	+ \$0	

Textile Grade	Code	Price	
Grade 1 Fabric/Vinyl	FG1/VG1	+ \$0	

*Upholstery options are restricted to the 20 textiles that are available in the WFH program. For laminate swatches see Fabric and Finishes on page 17.*

### 3. Mechanism

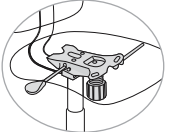
Mechanism	Code	Price	
Swivel-Tilt	T	+ \$0	

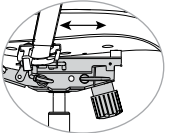
Standard Synchro With Seat-Depth Adjustment	F/E3	+ \$85	
---	------	--------	--

### 4. Frame

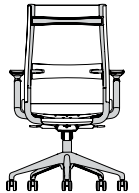
Frame Color	Code	Price	
Black	FC1	+ \$0	
White	FC12	+ \$41	

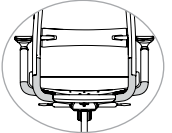
Back Support Color	Code	Price	
Black (For Black Frame FC1)	Z1	+ \$0	
White (For White Frame FC12)	Z4	+ \$0	

5. Arms

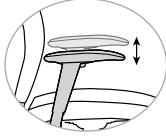
Arm Style	Code	Price	
Armless	AR0	+ \$0	
Height-Adjustable	AR4	+ \$41	

Arms, if specified, come with fog arm pads for the white and fog frames and black arm pads for the black frame.

6. Base

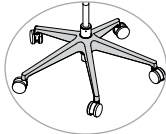
Base Style	Code	Price	
Nylon Base	BT1	+ \$0	

Base Color	Code	Price	
Black (For Black Frame FC1)	BC1	+ \$0	
White (For White Frame FC12)	BC3	+ \$0	

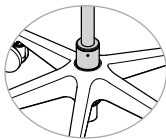
Cylinder Height	Code	Price	
Standard Cylinder	CH1	+ \$0	

Casters or Glides	Code	Price	
Hard Floor and Carpet Casters	CS6	+ \$0	

7. Packaging

Packaging	Code	Price	
Knocked Down	KD	+ \$0	

SPECIFICATIONS

	2222 B1 Midback Mesh Task Chair	2223 B1 Highback Mesh Task Chair
Overall Width Armless	25"	25"
Overall Width With Arms	26"	26"
Overall Depth	25"	25"
Overall Height	36.75"	40.75"
Seat Width	20"	20"
Seat Depth	17.5"-19.5"	17.5"-19.5"
Seat Height	17.5"-21.25" (T) 17.75"-21.5" (F/E3)	17.5"-21.25" (FT) 17.75"-21.5" (F/E3)
Back Width	18.75"	18.75"
Back Height	19"	23"
Weight Armless	30 lb	31 lb
Weight With Arms	36 lb	37 lb
Weight Capacity Warranty	300 lb	300 lb

Swivel-tilt mechanism (T). Standard synchro mechanism (F). Seat-depth adjustment (E3).

# Accessories

HOME EDITION ANTI-FATIGUE MAT, MONITOR ARMS, POWER, WIRE MANAGEMENT, SIT-TO-STAND, AND FILING

## Anti-Fatigue Mat – Home Edition

Product Type	Code	Price	
20" x 30" Black Anti-Fatigue Mat	3153 AFM01	\$216	

## EON – Home Edition

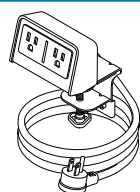
Product Type	Code	Price	
Clamp On Dual Outlet	H3130 PTC PT5	\$150	

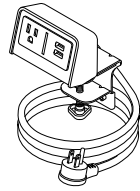
EON Clamp On, Single Outlet, Dual USB	3130 PTC PT2	\$218	
---------------------------------------	--------------	-------	--

Color	Code	Price	
Black	PC1	+ \$0	
White	PC4	+ \$0	

Two USB-A Port option (PT2) is available in black only (PC1).

## Cable Caddy Basket – Home Edition

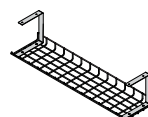
Product Type	Code	Price	
Wire Management	H3152 WM05	\$108	

Color	Code	Price	
Black	WM03	+ \$0	

## High Tide – Home Edition

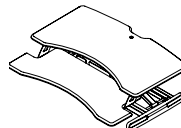
Product Type	Code	Price	
Desktop Sit-to-Stand	H3120 SSHT4 MAT00	\$636	

## Mobio – Home Edition

Product Type	Code	Price	
Monitor Arm	H3210	+ \$0	

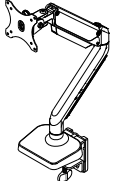
Product Style	Code	Price	
Single Desk	MAT33	\$299	

Dual Desk	MAT34	\$447	
-----------	-------	-------	--

Paint Color	Code	Price	
Black	MAC03	+ \$0	
White	MAC02	+ \$0	

## Power Strip – Home Edition

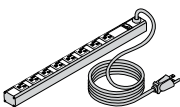
Product Type	Code	Price	
Power Strip	H3130 PST1 WM00	\$182	

## Mobile Pedestal – Home Edition

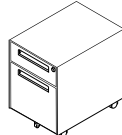
Product Type	Code	Price	
Mobile Pedestal No Upholstered Cushion	H3150 CPT00	\$476	

Paint Color	Code	Price	
White	PDC02	+ \$0	
Black	PDC03	+ \$0	

## Safety First

To ensure proper cleaning and/or disinfecting, it's important to consult with facilities or safety personnel and follow the manufacturer's instructions—including detailed dilution requirements, safe application instructions, dwell time for effective disinfecting and more.

Per CDC instructions, always read and follow the directions on the label to ensure safe and effective use.

- Wear skin protection and consider eye protection for potential splash hazards
- Ensure adequate ventilation
- Use no more than the amount recommended on the label
- Use water at room temperature for dilution (unless stated otherwise on the label)
- Avoid mixing chemical products
- Label diluted cleaning solutions
- Store and use chemicals out of the reach of children and pets

Always read and follow the directions on the cleaner/disinfectant labels to ensure safe and effective use.

## Clean + Disinfect

Cleaning and disinfecting are two distinct actions, and knowing the difference between the two can help promote safety in any space. This comprehensive, 2-step process requires cleaning before disinfecting.

## Clean

### CLEANING REMOVES GERMS

- The act of removing visible dirt and debris from objects or surfaces
- Cleaning works by using soap/detergent with water to remove impurities from surfaces either manually or mechanically
- Cleaning does not kill germs, but by removing them, it lowers their numbers and risk of spreading infection

## Clean (Cont.)

### CLEANING GUIDELINES AND TIPS

- Start by lightly dusting with a soft, grit-free cloth or chamois (no wiping)
- After dusting, dampen cloth or chamois with a solution of mild, non-abrasive liquid soap and water
- Wipe clean and dry with a soft, grit-free cloth, sponge or chamois
- Avoid using abrasive cleaners and steel wool to prevent scratching
- Test any cleaning method or agent in an inconspicuous area of the surface

## Disinfect

### DISINFECTING KILLS GERMS

- This process comes after a surface is cleaned
- Disinfecting kills germs on objects or surfaces with the use of chemicals
- Most common disinfectants include one of the following active ingredients: Quaternary Ammonium (Quats), Sodium Hypochlorite (Bleach), Hydrogen Peroxide, or 70% Isopropyl Alcohol
- EPA-registered disinfectants List N: Disinfectants for Use Against SARS-CoV-2

### DISINFECTING GUIDELINES AND TIPS

- Follow the disinfectant manufacturer's instructions when applying the agent
- Once finished, remove all disinfecting agents from the surface with water and a grit-free cloth, then dry
- If not properly removed, disinfectant residue could degrade product life and appearance

## Cleaning Our Hard Surfaces

Over 95% of the hard surfaces on our products can be cleaned/disinfected using any one of the four primary ingredients listed below.

- Bleach (Sodium Hypochlorite)
- Hydrogen Peroxide
- Quaternary Ammonium Compounds (Quats)
- 70% Isopropyl Alcohol

### EXAMPLES OF HARD SURFACES THAT CAN BE DISINFECTED:

- Plastics (i.e. polyurethane and acrylic)
- Solid Surface
- Metals
- Painted Surfaces
- Laminate

### EXCEPTIONS:

- Veneer
- Wood Surfaces

## Cleaning Our Soft Surfaces

Our textiles and meshes offer a performance and cleaning story unmatched in the industry.

### MESH:

- All of our mesh materials are bleach-cleanable. This determination is supported by 3rd-party results from completing AATCC 188 Colorfastness to Bleach testing where the subject material is submerged, and friction stirred in a diluted sodium hypochlorite solution.
- Cleaning of our mesh materials varies. Check out the [Mesh Spec + Care Guide](#) on our website for more information.

### SEATING FABRICS:

- Soft surfaces on seating can vary widely from woven, knits and leather to coated textiles such as vinyl and polyurethane. Woven and knits tend to be more permeable than vinyl or polyurethane.
- Cleaning of our seating fabric materials varies. For a list of our textile spec + care guides, see the [Materials Downloads](#) on our website.

# LAMINATE CARE AND CLEANING

## Clean

### CLEANING GUIDELINES AND TIPS

Thermally fused melamine finished panels may be easily cleaned using a mild, non-abrasive, all-purpose cleaner and a soft cloth.

Coffee, tea or other difficult stains may be removed using a mild household detergent or a paste of baking soda and water.

Note: 10–20 strokes should remove most stains, excessive force or scrubbing may damage the surface.

### NO HARSH CHEMICALS

Should the surface come in contact with drain, toilet or oven cleaner, immediately remove the chemical, rinse thoroughly and wipe dry.

### NO ABRASIVES

Abrasives such as scouring pads or gritty cleansers may permanently dull and/or scratch the surface and result in future staining.

## Protect

### AVOID HEAT







Do not place hot cookware, dishes or objects onto the surface. Protect surfaces from heat with an insulating pad or trivet.

### NOTHING SHARP

Knives and other sharp objects used directly on the surface can also be damaging. Protect surfaces from sharp objects with a chopping block or counter protector.

# FABRIC AND FINISHES







## Laminate

Finish	Code	Price	
Black	TL19	+ \$0	
Cabinet Maple	TL21	+ \$0	
Folkstone	TL24	+ \$0	
Sandalwood	TL27	+ \$0	
Walnut Amati	TL28	+ \$0	
White	TL29	+ \$0	



















## Bamboo

Finish	Code	Price	
Clear	TL30	+ \$0	

## Mesh

Mesh Color	Code	Price	
Fog Woven Striped	MC37	+ \$0	
Onyx Woven Striped	MC35	+ \$0	
Apple	MC31	+\$0	
Desert	MC22	+\$0	
Electric Blue	MC24	+\$0	
Fire	MC25	+\$0	
Fog	MC23	+\$0	
Nickel	MC21	+ \$0	
Onyx	MC20	+ \$0	
Tangerine	MC28	+\$0	

## Fabric

Pattern	Price	
<b>Huntington</b>		
Fleece	+ \$0	
Meteor	+ \$0	
Natural	+ \$0	
<b>Malibu</b>		
Lemongrass	+ \$0	
Navy	+ \$0	
Orange	+ \$0	
Ruby	+ \$0	
Soot	+ \$0	
Violet	+ \$0	
<b>Spice</b>		
Electric Blue	+ \$0	
Fire	+ \$0	
<b>Sugar</b>		
Sugar Licorice	+ \$0	
<b>Venice</b>		
Apple	+ \$0	
Carbon	+ \$0	
Deep Sea	+ \$0	
Gold Dusk	+ \$0	
Mainstream	+ \$0	
Milestone	+ \$0	
Sandstorm	+ \$0	
Sundown	+ \$0	