



CASCHA[®] FURNITURE

PRICE LIST

EFFECTIVE APRIL 9, 2026
800.424.2432

Contents

Refer to KI Terms & Conditions document or visit ki.com.



Contents

Refer to KI Terms & Conditions document or visit ki.com.

Fabric Yardage Pricing	3
Ordering Customer's Own Material (C.O.M.) Upholstery	4
Cascha™ Lounge Seating	
Technical Specifications	6
Product Color Options	17
Lounge Chair, Armless, Sled Base	18
Lounge Chair, Armless, Sled Base, With Welting	19
Lounge Chair, Armless, Wood Four-Leg Base	20
Lounge Chair, Armless, Wood Four-Leg Base, With Welting	21
Lounge Chair, Armless, Metal Swivel Base with Casters	22
Lounge Chair, Armless, Metal Swivel Base with Casters, With Welting	23
Lounge Chair, Armless, Metal Swivel Base	24
Lounge Chair, Armless, Metal Swivel Base, With Welting	25
Lounge Chair, Armless, Wood Swivel Base	26
Lounge Chair, Armless, Wood Swivel Base, With Welting	27
Lounge Chair, Armless, Rocking Base	28
Lounge Chair, Armless, Rocking Base, With Welting	29
Ottoman, Wood Swivel Base	30
Ottoman, Wood Swivel Base, With Welting	31
Ottoman, Metal Swivel Base	32
Ottoman, Metal Swivel Base, With Welting	33
Cascha™ Guest Seating - Armless	
Guest Chair, Armless, Metal Four-Leg Base	34
Guest Chair, Armless, Metal Four-Leg Base, With Welting	35
Guest Chair, Armless, Wood Four-Leg Base	36
Guest Chair, Armless, Wood Four-Leg Base, With Welting	37
Guest Chair, Armless, Height Adjustable, Metal Swivel Base With Casters	38
Guest Chair, Armless, Height Adjustable, Metal Swivel Base With Casters, With Welting	39
Guest Chair, Armless, Height Adjustable, Metal Swivel Base	40
Guest Chair, Armless, Height Adjustable, Metal Swivel Base, With Welting	41
Guest Chair, Armless, Wood Swivel Base	42
Guest Chair, Armless, Wood Swivel Base, With Welting	37
Cascha™ Guest Seating - With Arm	
Guest Chair, With Arm, Metal Four-Leg Base	44
Guest Chair, With Arm, Metal Four-Leg Base, With Welting	45
Guest Chair, With Arm, Wood Four-Leg Base	46
Guest Chair, With Arm, Wood Four-Leg Base, with Welting	47
Guest Chair, With Arm, Height Adjustable, Metal Swivel Base With Casters	48
Guest Chair, With Arm, Height Adjustable, Metal Swivel Base With Casters, With Welting	49
Guest Chair, With Arm, Height Adjustable, Metal Swivel Base	50
Guest Chair, With Arm, Height Adjustable, Metal Swivel Base, With Welting	51
Guest Chair, With Arm, Wood Swivel Base	52
Guest Chair, With Arm, Wood Swivel Base, With Welting	53
Cascha™ Stools - Armless	
Stool, Armless, Metal Four-Leg Base, 24" High	54
Stool, Armless, Metal Four-Leg Base, 24" High, With Welting	55
Stool, Armless, Metal Four-Leg Base, 30" High	56
Stool, Armless, Metal Four-Leg Base, 30" High, With Welting	57
Stool, Armless, Wood Four-Leg Base, 24" High	58
Stool, Armless, Wood Four-Leg Base, 24" High, With Welting	59
Stool, Armless, Wood Four-Leg Base, 30" High	60
Stool, Armless, Wood Four-Leg Base, 30" High, With Welt	61
Stool, Armless, Height Adjustable, Metal Swivel Pedestal Base	62
Stool, Armless, Height Adjustable, Metal Swivel Pedestal Base, With Welting	63
Cascha™ Stools - With Arm	
Stool, With Arm, Metal Four-Leg Base, 24" High	64
Stool, With Arm, Metal Four-Leg Base, 24" High, With Welting	65
Stool, With Arm, Metal Four-Leg Base, 30" High	66
Stool, With Arm, Metal Four-Leg Base, 30" High, With Welting	67
Stool, With Arm, Wood Four-Leg Base, 24" High	68
Stool, With Arm, Wood Four-Leg Base, 24" High, With Welting	69
Stool, With Arm, Wood Four-Leg Base, 30" High	70
Stool, With Arm, Wood Four-Leg Base, 30" High, With Welting	71
Stool, With Arm, Height Adjustable, Metal Swivel Pedestal Base	72
Stool, With Arm, Height Adjustable, Metal Swivel Pedestal Base, With Welting	73

Cascha™ Tables - Tops	
Round Table Tops, 24" Diameter	74
Cascha™ Tables - Bases	
Coffee Table and Side Table, Wood Base	75
Standard Height, Counter Height and Cafe Height Tables, Wood Base	76
Cascha™ Lounge Seating - Replacement Bases	
Replacement Lounge Chair Base	77
Replacement Ottoman Base	79
Cascha™ Guest Seating - Replacement Bases	
Replacement Guest Chair Base	81
Replacement Stool Base	85
Cascha™ Lounge Seating - Replacements	
Replacement Lounge Chair Back and Seat	87
Replacement Ottoman Seat	89
Replacement Ottoman Seat, With Welting	90
Cascha™ Guest Seating - Replacements	
Replacement Guest Chair Back and Seat, Armless	91
Replacement Guest Chair Back and Seat, With Arm	93
Cascha™ Stools - Replacements	
Replacement Stool Back and Seat, Armless	95
Replacement Stool Back and Seat, With Arm	97
Cascha™ Guest Seating - Replacement Kits	
Replacement Guest Chair & Stool, Arm Kit	99
Cascha™ Lounge Seating - Replacement Kits	
Replacement Base Kits	101



Yardage	Grade	List Price Per Yard
1	C	\$ 49
1	D	\$ 64
1	E	\$ 78
1	F	\$ 100
1	G	\$ 122
1	H	\$ 144
1	I	\$ 178
1	J	\$ 222
1	K	\$ 289
1	L	\$ 333
1	M	\$ 422

To calculate the fabric option price, multiply the model's total yardage by the fabric grade's list price per yard. Add this fabric option price to the base model price to determine the total price. Fabric yardage can be found on the model pricing page.



Customer's Own Material ■

Specifications Form

January 2023

How to Specify

As a standard procedure, KI applies seating upholstery as swatched by the textile distributor. Reference distributor's website. Upholstery that is required to be applied differently than is swatched, will need a Product Modification Request written specifying the direction the upholstery is to be applied.

Seating upholstery requiring specific positioning of intricate patterns or patterns repeats on seats and backrests, will need a Product Modification Request written including a sketch noting the specific requirements, as in Diagram A.

C.O.M. must be supplied in continuous yardage.

Yardage requirements listed in price list are based on plain goods 54" wide. Fabrics less than 54" wide, or those requiring matching (stripes, plaids, prints, large patterns) will require additional yardage based on the fabric used and the item ordered. Consult matrix below for additional yardage needed.

C.O.M. INCREASE MATRIX (yardage matrix is also applicable to any reservations of KI Ingrade, Pallas, or K.O.M. upholsteries).

This table is a general guide.

FABRIC WIDTH	PLAIN FABRIC	UNDER 7"	8"-13"	14"-21"	22"-27"	28"-33"	34"-40"	41"-48"
	REPEAT	REPEAT	REPEAT	REPEAT	REPEAT	REPEAT	REPEAT	REPEAT
54"	0	20%	25%	30%	45%	55%	70%	80%
51"-53"	15%	25%	30%	35%	50%	60%	80%	90%
48"-50"	20%	30%	35%	40%	55%	65%	85%	95%
45"-47"	30%	45%	50%	55%	60%	80%	90%	100%
36"-44"	50%	65%	70%	75%	80%	100%	110%	120%

Fabric with double repeat: If using a fabric with a double repeat, please follow this formula: take the total amount of the larger and half of the smaller repeat; add together to find the correct overall repeat. Example: 10" vertical with 14" horizontal would be $14+5=19$.

If fabric comes in on multiple rolls, one additional yard per roll needs to be added to the yardage requirement.

Leather hides must be a minimum of 50 square feet of usable material. The outer edges cannot be calculated as square feet or yardage. To determine square footage, multiply unit yardage by 18 square feet to obtain the total square footage required per unit.

For exact production yardage requirements, call 1-800-424-2432, ext. 2707.

Production

Customer's upholstery must be approved prior to acceptance for production.

After approval, a memo swatch of the C.O.M. from the textile distributor must accompany the order. KI assumes no responsibility for wear, defects, or performance of C.O.M. or K.O.M. upholstery.

C.O.M. not received into the appropriate facility 3 weeks prior to acknowledged delivery date may go on hold. See KI C.O.M.

Shipping Location listing for the correct facility address by product.

All C.O.M. must be labeled as follows:

1. Name and address
2. Your purchase order number
3. Our style number to which fabric is to be applied
4. Supplier name and fabric name, number, and color

ALL C.O.M. Shipments must be prepaid. Collect shipments will be refused.

Testing

When KI requires testing, actual yardage to upholster one chair may be required. The C.O.M. Specialist will confirm model and fabric testing requirements when applicable.

Approved test samples will be applied to the order or will be held for 6 months. After 6 months, the sample will no longer be applied to your order. For all product testing, send fabric samples to the manufacturing facility. See KI C.O.M. Shipping Location listing for the correct facility address by product.

ALL C.O.M. Shipments must be prepaid. Collect shipments will be refused.

Treated Materials

If C.O.M. requires processing such as a stain resistance treatment or acrylic backing, it may shrink. To prevent delays in delivery or back ordering due to shrinkage, please have your processor verify measurement after processing and assure adequate yardage shipped.

Split Orders

If a portion of the shipment which does not require C.O.M. application is to be processed and shipped early, KI will enter the order immediately at your request. These split shipments are subject to minimum order changes.

Excess Upholstery Material

KI will dispose of excess upholstery material at the time of shipment unless expressly requested to return it with the product shipment.

Cancelled or Changed Orders

KI assumes no responsibility for extra C.O.M. due to a change of upholstery or cancellation of an order. If it the customer's responsibility to arrange for return of the material.

Contact the C.O.M. Specialist at 1-800-424-2432, ext. 2707, with questions or to request a split order

Diagram A

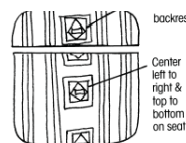



C.O.M. SHIPPING LOCATION



Architectural Walls	Panel Systems	Impress Ultra OM
Evoke MN	All Terrain..... KP	Intellect Wave GB
Genius MN	Balance MN	Jessa HN
Casegoods	Universal MN	Jubilee VQ
Aristotle..... MN	Wireworks MN	Katera..... GB
Likha..... MN	Unite..... MN	Kurv Benches..... HN
Classroom Furniture	Residence Hall Furniture	Learn2..... GB
Cogni GB	RoomScape..... MN	LimeLite..... GB
Intellect Wave GB	Screens	Lyra HN
Learn2..... GB	All Terrain..... KP	Medical & Laboratory Stools..... OM
Ruckus..... GB	Connection Zone..... BW	MyPlace HN
Desking	Tributaire..... BW	MyWay HN
700 Series KP	True/Volition KP	Oath GB
Balance MN	Genesis..... KP	Opt4 GB
Genesis MN	Tattoo..... MN	Pilot OM
True KP	Universal..... BW	Promenade..... BW
Universal MN	Seating	Ruckus..... GB
WorkZone MN	600 Series..... BW	Sela HN
Files & Storage	Affina HN	Sift GB
700 Series..... GB	Altus GB	Signia..... OM
Connection..... BW	Apply GB	Soltice Metal HN
U-Series..... GB	Calida HN	Soltice..... HN
Tattoo..... BW	Cascha VT	Sonrisa HN
Fixed Seating	Civara VT	Strive..... GB
Concerto..... BW	Clamber HN	Sway BW
Single Pedestal GB	Cogni GB	Tattoo..... HN
Jury Base GB	Diem OM	Torsion-on-the-Go! GB
Lancaster..... BW	Doni GB	Torsion Air GB
Sequence GB	Gladly VQ	Zeker HN
University GB	Grazie GB	Zentori VT
	Hub HN	Zoetry HN
	Impress OM	

KI C.O.M. Manufacturing Site Addresses:

BW
 KI Bonduel
 Attn: COM Storage
 204 West South St.
 Bonduel, WI 54107

HN
 KI High Point
 Attn: COM Storage
 217 Feld Avenue
 High Point, NC 27263

MN
 KI Manitowoc
 Attn: COM Storage
 1400 S. 41st St.
 Manitowoc, WI 54220

VQ
 KI
 Attn: COM Fabrics
 6892 Marlin Circle
 La Palma, CA 90623

GB
 KI Green Bay
 Attn: COM Storage
 1687 Westminster Drive - Gate 3
 Green Bay, WI 54302

KP
 KI Pembroke
 Attn: COM Storage
 1000 Olympic Dr.
 Pembroke, Ontario K8A6X7

OM
 KI
 Attn: COM Storage
 1110 S. Mildred Ave.
 Ontario, CA 91761

VT
 KI
 Attn: COM Storage
 2803 South Taylor Drive
 Sheboygan, WI 53081



Lounge Chairs

Seat & Backrest Shell Construction

All seat and backrest structures are constructed of a 1/2" thick formed, then CNC-cut continuous curved hardwood plywood. Plywood underside includes threaded inserts for installation of lounge chair bases as specified.

Upholstered Seat & Backrest

Seat top and backrest front foam thickness is 1 1/2". Seat back and seat underside foam thickness is 1/4". All foam is glued to the continuous curved plywood structure, then upholstered using heat-activated glue. Upholstered Cascha lounge chairs are sewn with double needle top stitch, when no welting is present. Units may be specified with contrasting or non-contrasting upholstery choices. Specific models include decorative welting defining the seam between the top and front user surfaces around the perimeter. See Product Color Options page in the Cascha Pricelist for upholstery options offered.

Lounge Chair Frames

Sled Base

Made from 16 mm diameter, 1.5 mm thick steel tubing, formed and welded. Frames are finished with baked-on electrostatically applied powder-coat paint in select KI colors to customer specification or may be specified as duplex nickel-chrome plated. Bases come equipped with fixed nylon saddle glides, attached underneath with a zinc plated screw (silver appearance). Frame attaches into threaded inserts under the upholstered chair using two M6 x 35mm and two M6 x 18mm screws and into threaded inserts on the back of the upholstered chair using two M6 x 18mm screws. Screws are black oxide when powder-coat paint is specified on the frame, and zinc plated (silver appearance) when any other finish is specified.

Wood 4-Leg Base

Four legs are milled out of solid Ash. Legs are stained in select KI colors to customer specification then clear coated. See Product Color Options in the Cascha Furniture Pricelist. Two steel supports join the wood leg assemblies using eight M6 x 18 black oxide screws. The metal support secures to the underside of the lounge using four M6 x 18 black oxide screws. Steel support is powder-coat painted Black. Base glide options available are none, felt or nylon. Glides each are attached using one #4 x 5/8" wood screw.

Metal Swivel Base

Four-spoke base is constructed of die-cast aluminum, finished with baked-on electrostatically applied powder-coat Black paint, or specified as polished aluminum. Base comes with either casters or glides. Available caster option is 50 mm O.D. double-wheel nylon. Optional push-in nylon glides are available with either felt or nylon pads adhered underneath. A steel support cylinder atop the four-spoke base which swivels 360-degrees is finished with baked-on electrostatically applied powder-coat Black paint or may be specified as duplex nickel-chrome plated. Lounge is supported by a contoured top plate, of molded high-strength black plastic. Top plate attaches to threaded inserts in the underside of the lounge using four M6 x 30mm black oxide screws and external tooth lock washers.

Lounge Chair Frames (cont.)

Wood Swivel Base

Four pyramidal base legs are each milled out of solid Ash. Reinforced with a steel post. Legs are stained in select KI colors to customer specification then clear coated. See Product Color Options in the Cascha Furniture Pricelist. Each leg inserts into a leg support knuckle and is secured underneath with a #10 x 3/4" Phillips flat head screw. Leg support knuckle is constructed of steel, finished with baked-on electrostatically applied powder-coat Black paint. Fixed in the knuckle is a nylon bushing with a zinc-plated steel post, which swivels 360-degrees. Lounge is supported by a contoured top plate, of molded high-strength black plastic. Top plate attaches to threaded inserts in the underside of the lounge using four M6 x 30mm black oxide screws and external tooth lock washers. Base glide options available are none, felt or nylon. Glides each are attached using one #4 x 5/8" wood screw.

Rocking Base

Base is constructed of steel and wood. Upper base frame is made from 22 mm diameter, 2 mm thick steel tubing, formed and welded. Frame is finished with baked-on electrostatically applied powder-coat paint in select KI colors to customer specification or may be specified as duplex nickel-chrome plated. Attached to the frame using four M6 x 35mm zinc plated screws (silver appearance) is a pair of wood rockers made of solid Ash. Rockers are stained in select KI colors to customer specification then clear coated. See Product Color Options in the Cascha Furniture Pricelist. Upper base frame attaches into threaded inserts under the lounge using four M6 x 18mm screws. Screws are black oxide when powder-coat paint is specified on the frame, and zinc plated (silver appearance) when any other finish is specified.

Ottomans

Ottoman Shell Construction

Ottoman structures are constructed of a 1/2" thick formed, then CNC-cut continuous curved hardwood plywood. Plywood underside includes threaded inserts for installation of ottoman bases as specified.

Upholstery

Ottoman top foam thickness is 1" and underside foam thickness is 1/4". All foam is glued to the continuous curved plywood structure, then upholstered using heat-activated glue. Upholstered Cascha ottomans are sewn with double needle top stitch, when no welting is present. Units may be specified with contrasting or non-contrasting upholstery choices. Specific models include decorative welting defining the seam between the top and front user surfaces around the perimeter. See Product Color Options page in the Cascha Pricelist for upholstery options offered.

Ottoman Frames

Wood Swivel Base

Four pyramidal base legs are each milled out of solid Ash. Legs are stained in select KI colors to customer specification then clear coated. See Product Color Options in the Cascha Furniture Pricelist. Each leg inserts into a leg support knuckle and is secured underneath with a #10 x 3/4" Phillips flat head screw. Leg support knuckle is constructed of die-cast aluminum, finished with baked-on electrostatically applied powder-coat Black paint, or specified as polished aluminum. Fixed in the knuckle is a nylon bushing with a zinc-plated steel post, which swivels 360-degrees. Ottoman is supported by a contoured top plate, of molded high-strength black plastic. Top plate attaches to threaded inserts in the underside using four M6 x 30mm black oxide screws and external tooth lock washers. Base glide options available are none, felt or nylon. Glides each are attached using one #4 x 5/8" wood screw.



Ottomans (cont.)

Ottoman Frames (cont.)

Metal Swivel Base

Four-spoke base is constructed of die-cast aluminum, finished with baked-on electrostatically applied powder-coat Black paint, or specified as polished aluminum. Push-in nylon glides are available with either felt or nylon pads adhered underneath. A steel support cylinder atop the four-spoke base which swivels 360-degrees is finished with baked-on electrostatically applied powder-coat Black paint or may be specified as duplex nickel-chrome plated. Ottoman is supported by a contoured top plate, of molded high-strength black plastic. Top plate attaches to threaded inserts in the underside of the lounge using four M6 x 30mm black oxide screws and external tooth lock washers.

Guest Chairs

Seat & Backrest Shell Construction

All seat and backrest structures are constructed of a 1/2" thick formed, then CNC-cut continuous curved hardwood plywood. Plywood underside includes threaded inserts for installation of chair bases as specified.

Upholstered Seat, Backrest & Arms

Seat top and backrest front foam thickness is 1". Seat underside and seat back foam thickness is 1/4". Arms inside and outside foam thickness 1/2". All foam is glued to the continuous curved plywood structure, then upholstered using heat-activated glue. Upholstered Cascha guest chairs are sewn with double needle top stitch, when no welting is present. Units may be specified with contrasting or non-contrasting upholstery choices. Specific models include decorative welting defining the seam between the top and front user surfaces around the perimeter. See Product Color Options page in the Cascha Pricelist for upholstery options offered. Guest chairs are available with arms or without arms.

Guest Chair Frames

Metal 4-Leg Base

Legs are made from 18 mm diameter, 1.5 mm thick steel tubing, formed and welded. Bases are finished with baked-on electrostatically applied powder-coat paint in select KI colors to customer specification or may be specified as duplex nickel-chrome plated. See Product Color Options in the Cascha Furniture Pricelist. Bases come equipped with plastic press-in glides with either nylon or felt adhered to the bottom. Upper x-frame structure secures to threaded inserts in the underside of the chair using eight M6 x 18mm screws. Screws are black oxide when powder-coat paint is specified on the frame, and zinc plated (silver appearance) when any other finish is specified.

Wood 4-Leg Base

Four legs are milled out of solid Ash. Legs are stained in select KI colors to customer specification then clear coated. See Product Color Options in the Cascha Furniture Pricelist. A formed and welded steel 14 mm diameter rod x-frame support joins at the four leg tops, securing with one #4 x 5/8" screw each. X-frame support is baked-on electrostatically applied powder-coat painted in Black and attaches to the chair underside using eight M6 x 18mm black oxide screws. Base glide options available are none, felt or nylon. Glides each are attached using one #4 x 5/8" wood screw.

Guest Chairs (cont.)

Guest Chair Frames (cont.)

Metal Swivel Base

Four-spoke base is constructed of die-cast aluminum, finished with baked-on electrostatically applied powder-coat Black paint, or specified as polished aluminum. Base comes with either casters or glides. Available caster option is 50 mm O.D. double-wheel nylon. Optional push-in nylon glides are available with either felt or nylon pads adhered underneath. A steel support cylinder atop the four-spoke base which swivels 360-degrees is finished with baked-on electrostatically applied powder-coat Black paint or may be specified as duplex nickel-chrome plated. Adjustable-Height chair is supported by a contoured top plate, of molded high-strength black plastic which contains a height-adjust lever. Lever is only available duplex nickel-chrome plated. Press-fit in the support cylinder below and the top plate above is an adjustable-height class-4 gas cylinder. Top plate attaches to threaded inserts in the underside of the lounge using four M6 x 30mm Phillips black oxide screws and black oxide external tooth lock washers.

Wood Swivel Base

Four pyramidal base legs are each milled out of solid Ash. Legs are stained in select KI colors to customer specification then clear coated. See Product Color Options in the Cascha Furniture Pricelist. Each leg inserts into a leg support knuckle and are secured underneath with a #10 x 3/4" Phillips flat head screw. Leg support knuckle is constructed of die-cast aluminum, finished with baked-on electrostatically applied powder-coat Black paint, or specified as polished aluminum. Fixed in the knuckle is a nylon bushing with a zinc-plated steel post, which swivels 360-degrees. Chair is supported by a contoured top plate, of molded high-strength black plastic. Top plate attaches to threaded inserts in the underside using four M6 x 30mm black oxide screws and external tooth lock washers. Base glide options available are none, felt or nylon. Glides each are attached using one #4 x 5/8" wood screw.

Stools

Seat & Backrest Shell Construction

All seat and backrest structures are constructed of a 1/2" thick formed, then CNC-cut continuous curved hardwood plywood. Plywood underside includes threaded inserts for installation of Stool bases as specified.

Upholstered Seat & Backrest & Arms

Seat top and backrest front foam thickness is 1". Seat underside and seat back foam thickness is 1/4". Arms inside and outside foam thickness 1/2". All foam is glued to the continuous curved plywood structure, then upholstered using heat-activated glue. Upholstered Cascha stools are sewn with double needle top stitch, when no welting is present. Units may be specified with contrasting or non-contrasting upholstery choices. Specific models include decorative welting defining the seam between the top and front user surfaces around the perimeter. See Product Color Options page in the Cascha Pricelist for upholstery options offered. Stools are available with or without arms.

Stool Frames

Metal 4-Leg Frame

Fixed frame heights are available for 24" and 30" high stools. Legs are made from 16 mm diameter, 1.5 mm thick steel tubing. Formed and welded is an upper solid 12 mm diameter rod x-frame structure. Stool frames also include a formed 11 mm diameter solid rod welded-on foot ring. Bases are finished with baked-on electrostatically applied powder-coat paint in select KI colors to customer specification or may be specified as duplex nickel-chrome plated. See Product Color Options in the Cascha Furniture Pricelist. Bases come equipped with plastic press-in glides with either nylon or felt adhered to the bottom. Upper x-frame solid 12 mm diameter rod structure secures to threaded inserts in the underside of the chair using eight M6 x 18mm screws. Screws are black oxide when powder-coat paint is specified on the frame, and zinc plated (silver appearance) when any other finish is specified.

Stools (cont.)

Stool Frames (cont.)

Wood 4-Leg Frame

Fixed frame heights are available for 24" and 30" high stools. Legs are milled out of solid Ash. Legs are stained in select KI colors to customer specification then clear coated. See Product Color Options in the Cascha Furniture Pricelist. A formed and welded steel 12 mm diameter rod x-frame support joins at the four leg tops, securing with one #4 x 5/8" screw each. X-frame support is baked-on electrostatically applied powder-coat painted in Black and attaches to the chair underside using eight M6 x 18mm black oxide screws. Stool frames also include a formed 11 mm diameter solid rod foot ring. Foot ring is finished with baked-on electrostatically applied powder-coat paint in select KI colors to customer specification or may be specified as duplex nickel-chrome plated. Foot ring attaches to threaded inserts in the legs using four M6 x 22mm screws. Screws are black oxide when powder-coat paint is specified on the frame, and zinc plated (silver appearance) when any other finish is specified. Base glide options available are none, felt or nylon. Glides each are attached using one #4 x 5/8" wood screw.

Metal Swivel Pedestal Base

At the bottom of the base is a steel disk with dimensions of 450 mm diameter by 7 mm thick. The base bottom contains six nylon threaded glides allowing for minimal adjustability on un-level floors. Atop the base is a 50 mm diameter, 1.5 mm thick steel lower support post, secured from under the base by three M8 x 35mm flat Allen head screws. Lower support post holds an internally, press-fit adjustable-height class-4 gas lift cylinder with an adjustment range of 260 mm. Concealing the height-adjust cylinder and raising or lowering over of the lower support post is the upper seat support post with seat support. Support post consists of a steel cylinder of 60 mm diameter, 1.5 mm thick, 385 mm length. Includes a welded-on footrest of 25 mm diameter, 2 mm thick, 310 mm length. Welded to the top of the support post is the seat support which the top of the gas cylinder mates into. Integrated into the seat support is a height-adjust lever which activates the gas cylinder below. All steel base parts are finished with baked-on electrostatically applied powder-coat paint in select KI colors to customer specification or may be specified as duplex nickel-chrome plated. Upper seat support attaches to the stool underside using four M6 x 30 screws and external tooth lock washers. Screws are black oxide when powder-coat paint is specified on the frame, and zinc plated (silver appearance) when any other finish is specified.

Tables

Assembled table heights are: 16", 20", 29", 36" and 42". Tabletops and bases are ordered separately.

Tabletops

Tabletops all are 24" diameter, constructed of 3/4" thick high-density particleboard core, with high-pressure laminate top, and phenolic backing sheet. Total thickness of top is 7/8". Tabletops are available with 2 mm (73P) edge, or knife (KN3) edge.

Wood 4-Leg Base

Four pyramidal base legs are each milled out of solid Ash. Legs are stained in select KI colors to customer specification then clear coated. See Product Color Options in the Cascha Furniture Pricelist. Each leg inserts into a leg support knuckle and is secured underneath with a #10 x 3/4" Phillips flat head screw. Leg support knuckle is constructed of die-cast aluminum, finished with baked-on electrostatically applied powder-coat paint in select KI colors to customer specification or may be specified as polished aluminum. Leg support knuckle top contains a 50 mm diameter, Ash wood post sized for 16", 20", 29", 36", or 42" table heights. Post attaches to the leg knuckle below using one M8 x 40mm nickel-plated screw and two #6 x 5/8" zinc plated (silver appearance) when knuckle is polished or powder-coat paint is specified on the frame, or two #6 x 5/8" black oxide screws when black finish is specified. Post attaches above to a black fixed steel top plate, 3 mm thick using one M8 x 35mm zinc plated screw (silver appearance) and two #6 x 5/8" black oxide wood screws on the side. Top plate attaches to the underside of the tabletop using four #10 x 3/4" black oxide screws. Base glide options available are none, felt or nylon. Glides each are attached using one #4 x 5/8" wood screw.

Cascha Sled Base Lounge Chair - Armless - (model CALSL shown)

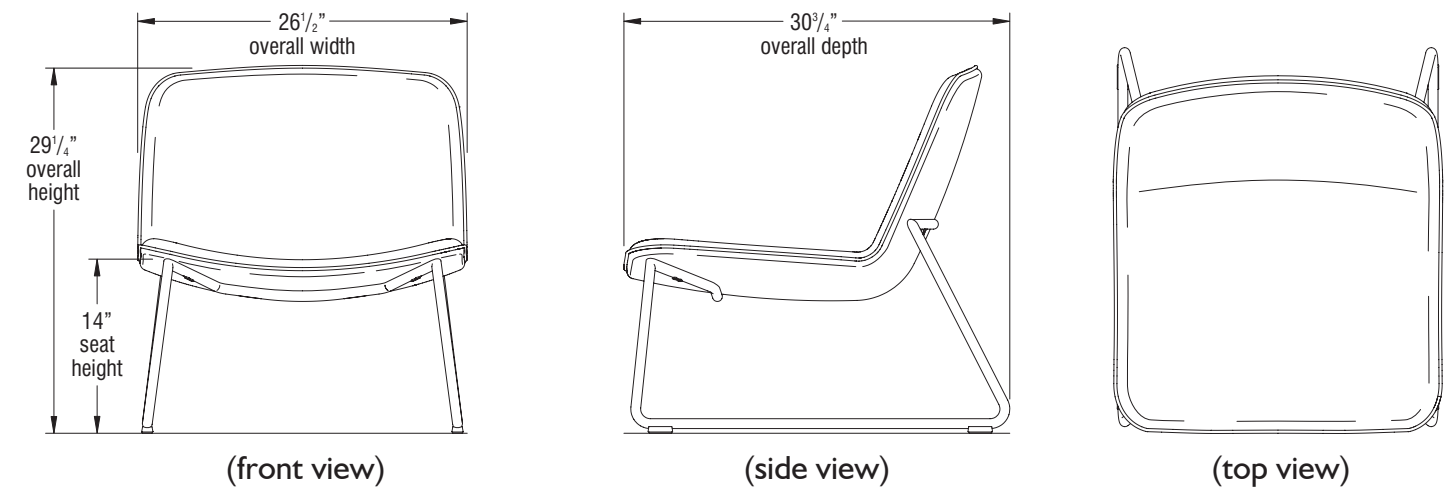

Cascha Wood 4-Leg Base Lounge Chair - Armless - (model CAL4W shown)

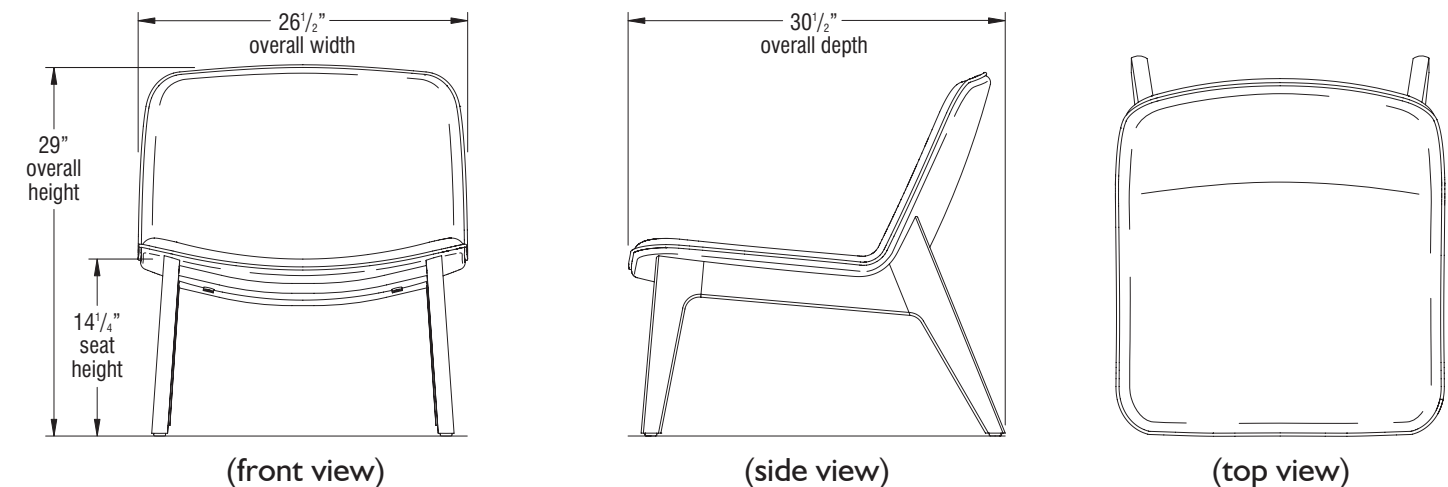

Cascha Metal Swivel Caster Base Lounge Chair - Armless - (model CALSC shown)

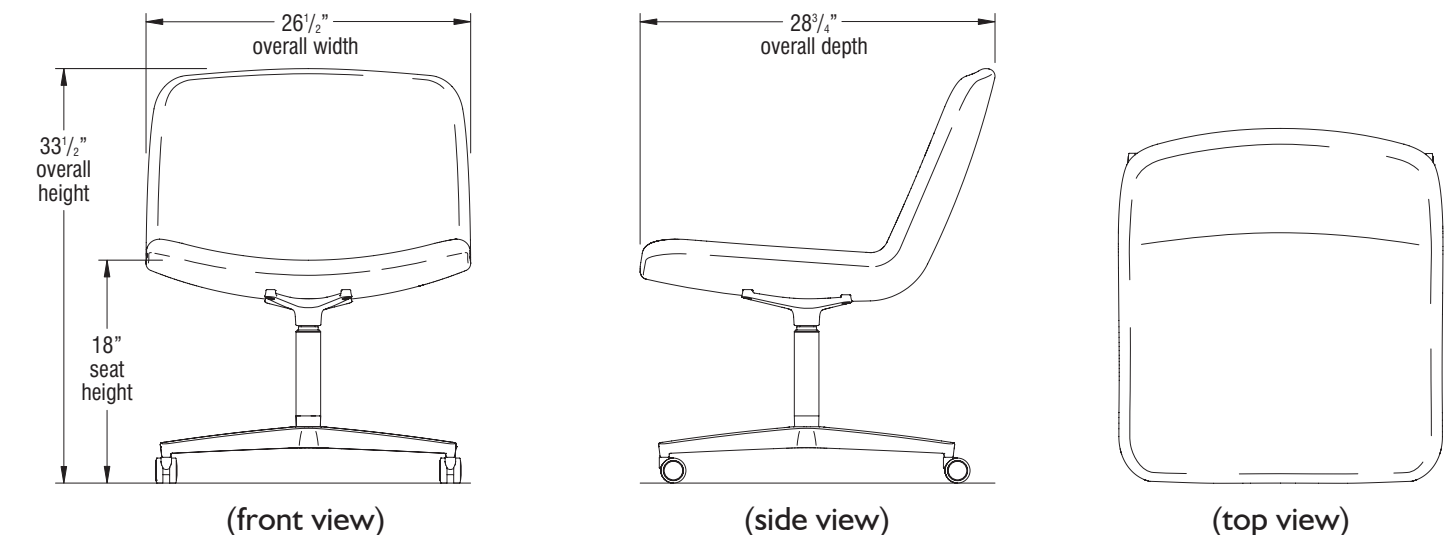



Cascha Metal Swivel Glide Base Lounge Chair - Armless - (model CALSG shown)

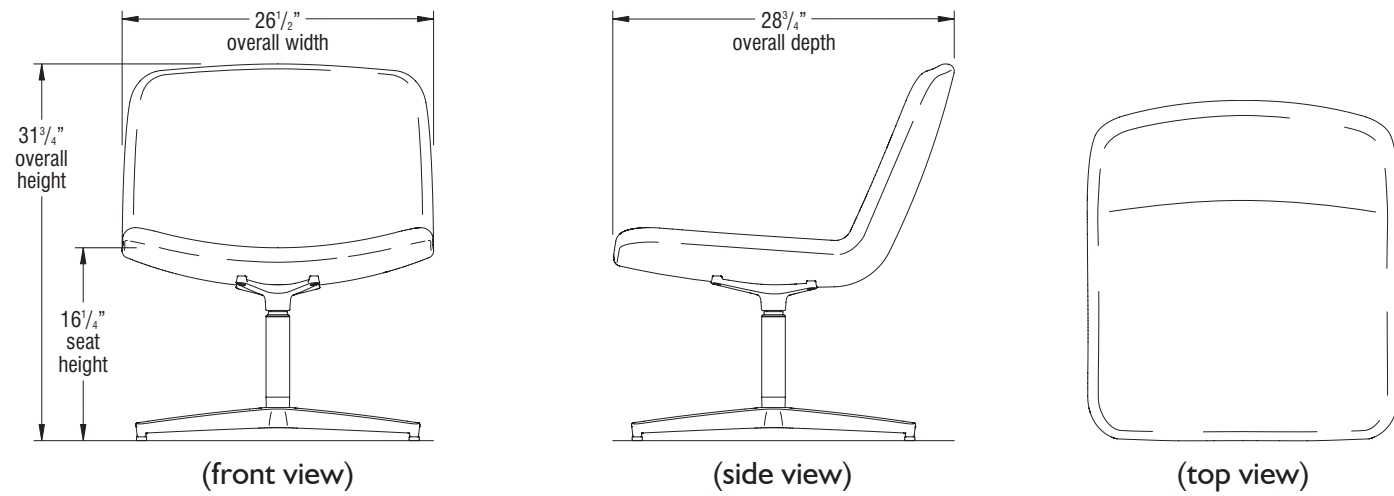

Cascha Wood Swivel Base Ottoman - (model CAF4K shown)

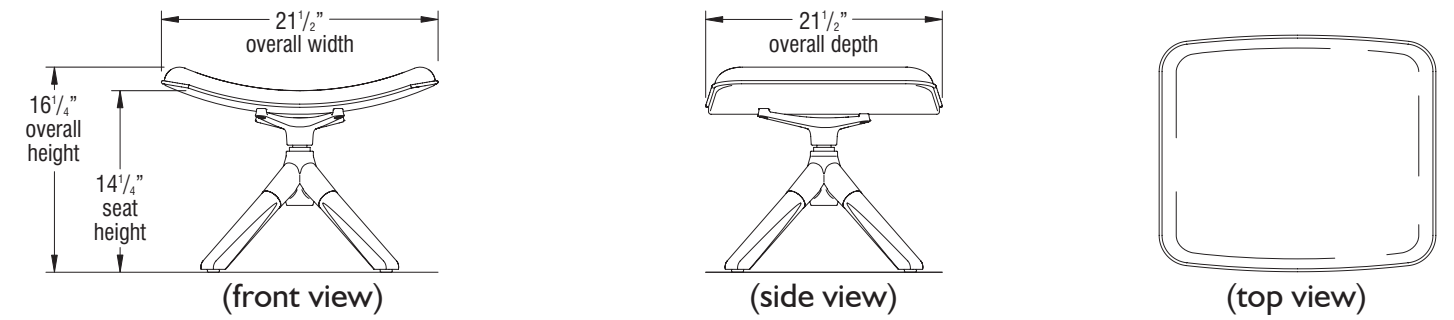

Cascha Wood Swivel Base Lounge Chair - Armless - (model CAL4K shown)

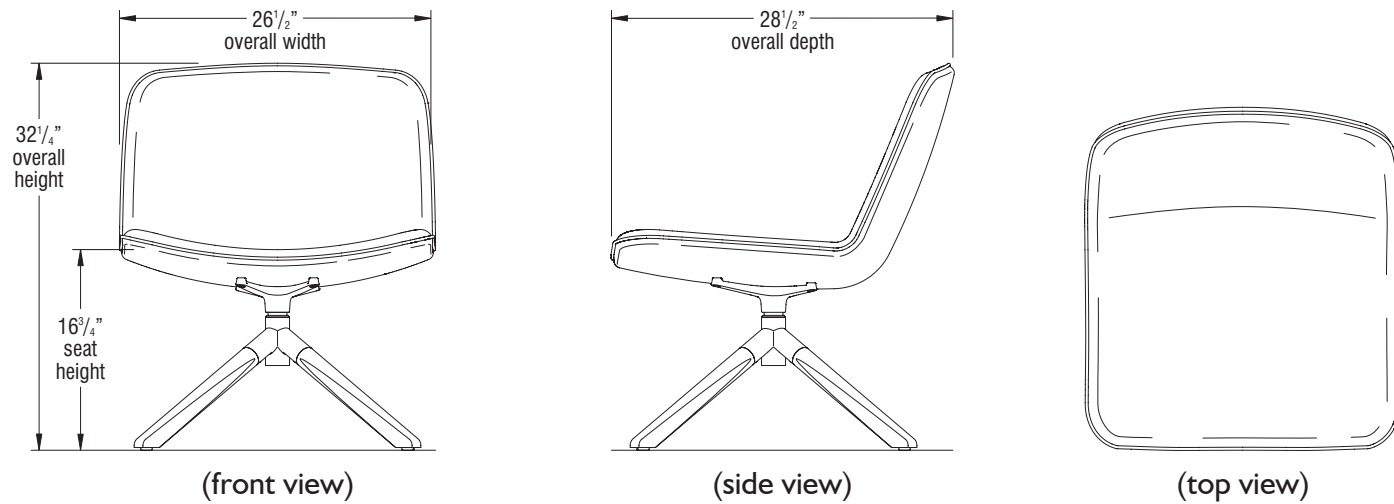

Cascha Metal Swivel Base Ottoman - (model CAFSG shown)

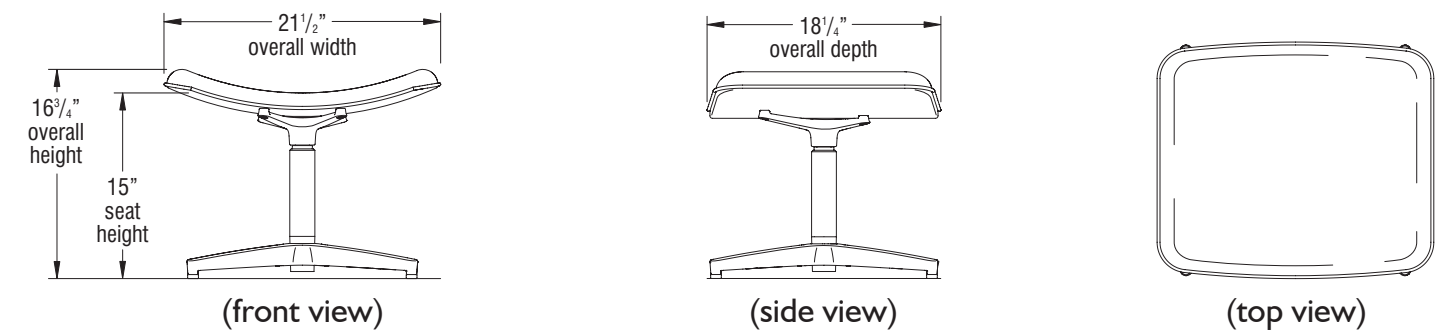

Cascha Rocking Base Lounge Chair - Armless - (model CALRW shown)

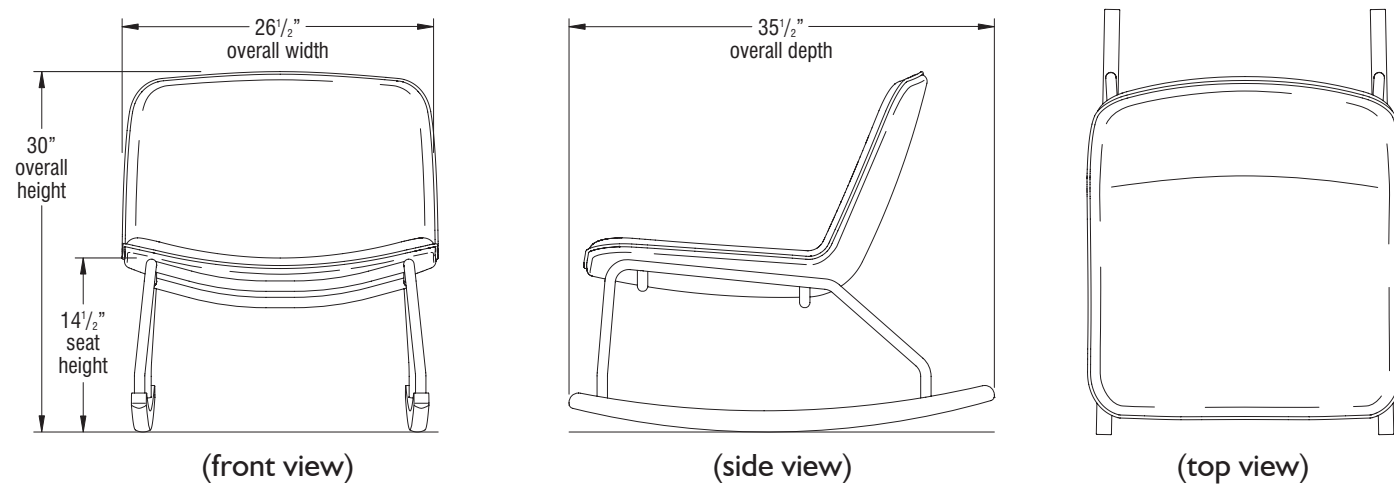

Cascha Metal 4-Leg Base Guest Chairs - (model CAM4M shown)

Model Number	A Overall Depth	B Overall Width	C Overall Height	D Seat Height	Armless	With Arms
CAG4M	23 1/2"	19 1/2"	34 1/2"	19 1/4"	•	
CAM4M	23 1/2"	23 1/2"	34 1/2"	19 1/4"		•

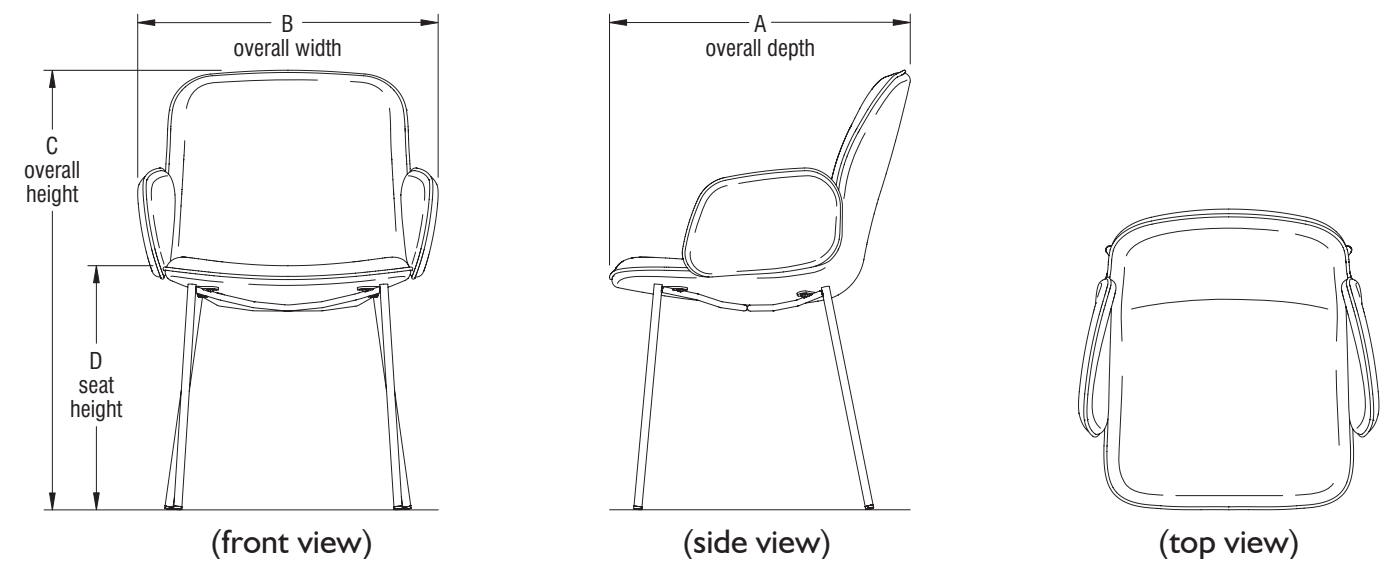



Cascha Wood 4-Leg Base Guest Chairs - (model CAM4W shown)

Model Number	A Overall Depth	B Overall Width	C Overall Height	D Seat Height	Armless	With Arms
CAG4W	23 1/2"	19 1/2"	34 1/2"	19"	•	
CAM4W	23 1/2"	23 1/2"	34 1/2"	19"		•

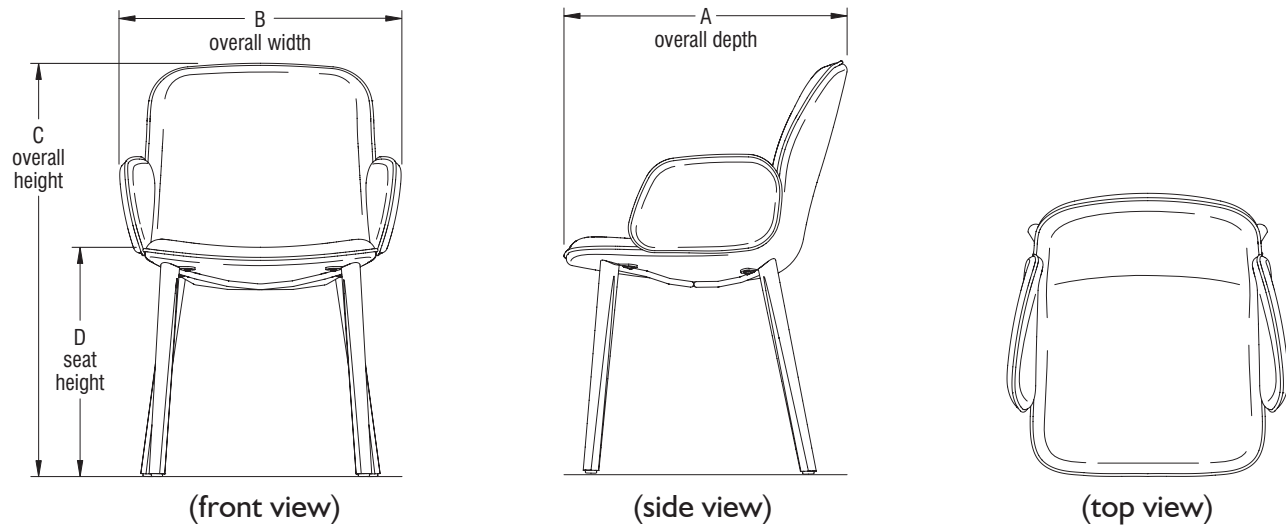

Cascha Metal Swivel Glide Base Guest Chairs - Adjustable-Height (model CAM4G shown)

Model Number	A Overall Depth	B Overall Width	C Overall Height	D Seat Height	Armless	With Arms
CAG4G	23 1/2"	19 1/2"	34 3/4" - 39 1/4"	19 1/2" - 24"	•	
CAM4G	23 1/2"	23 1/2"	34 3/4" - 39 1/4"	19 1/2" - 24"		•

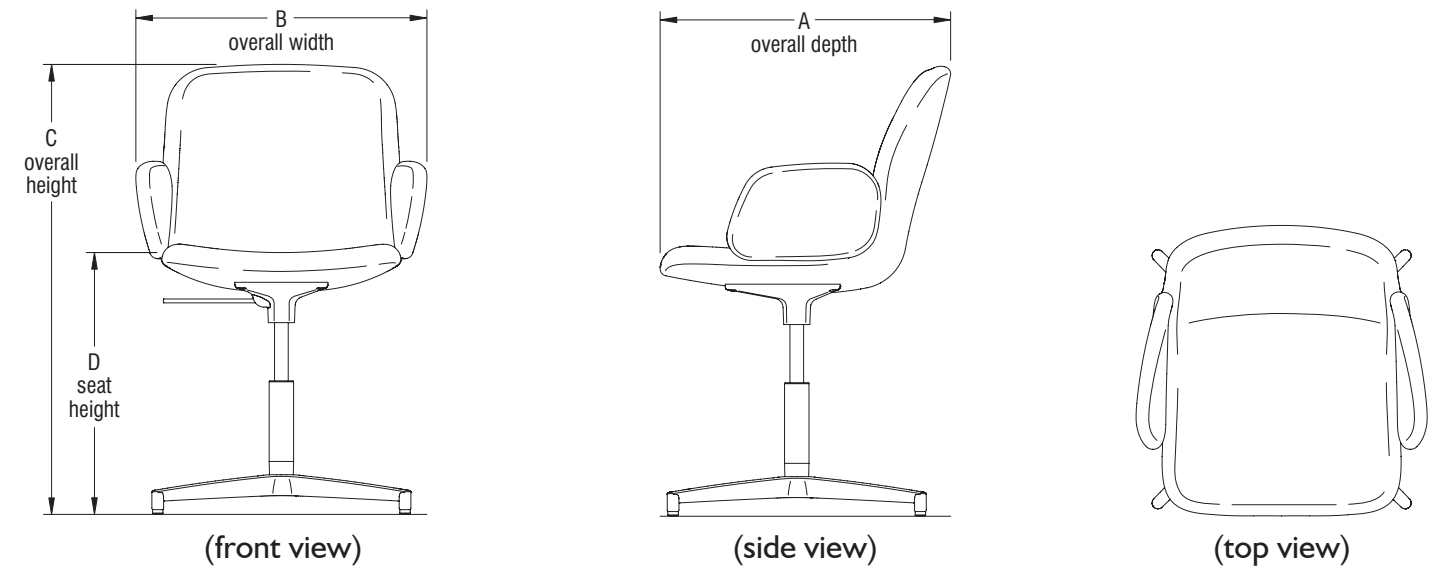

Cascha Metal Swivel Caster Base Guest Chairs - Adjustable-Height (model CAM4C shown)

Model Number	A Overall Depth	B Overall Width	C Overall Height	D Seat Height	Armless	With Arms
CAG4C	23 1/2"	19 1/2"	36 1/2" - 41"	21 1/4" - 25 3/4"	•	
CAM4C	23 1/2"	23 1/2"	36 1/2" - 41"	21 1/4" - 25 3/4"		•

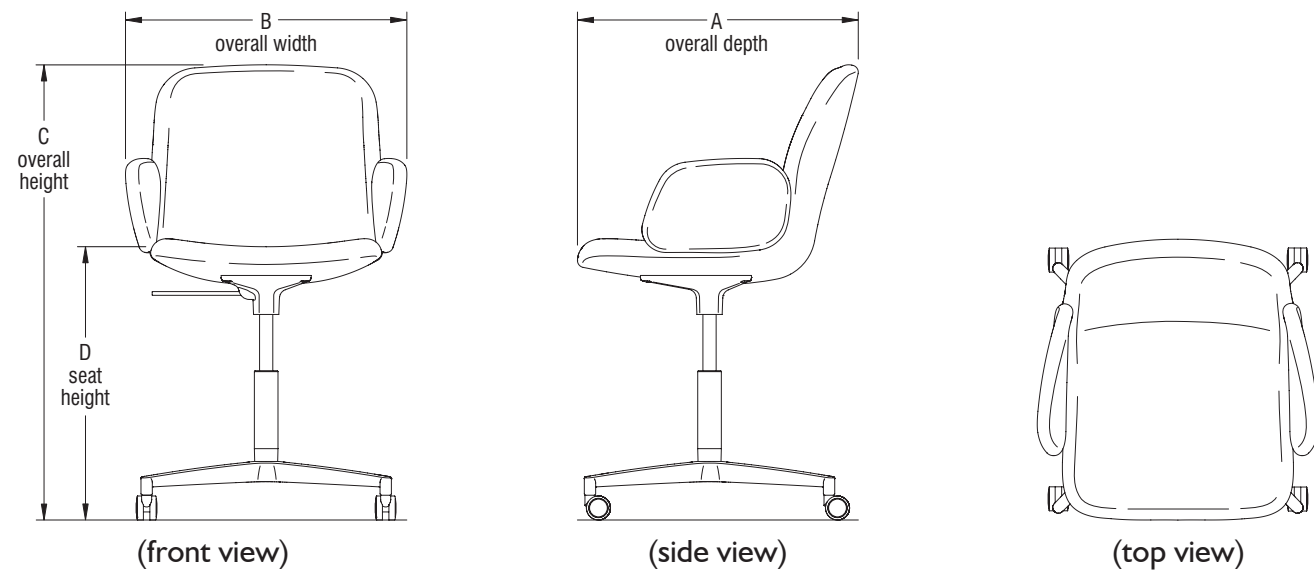

Cascha Wood Swivel Base Guest Chairs - (model CAM4K shown)

Model Number	A Overall Depth	B Overall Width	C Overall Height	D Seat Height	Armless	With Arms
CAG4K	23 1/2"	19 1/2"	33 1/4"	18 1/4"	•	
CAM4K	23 1/2"	23 1/2"	33 1/4"	18 1/4"		•

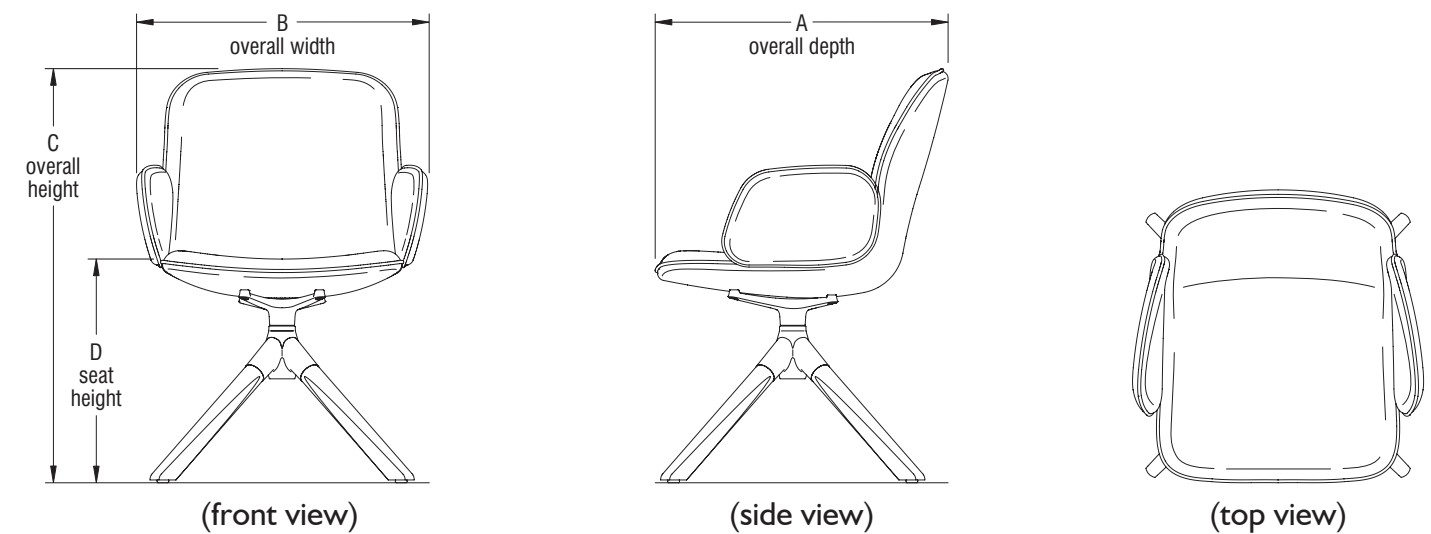



Cascha Metal 4-Leg Base Stools - (model CAR4M shown)

Model Number	A Overall Depth	B Overall Width	C Overall Height	D Seat Height	Armless	With Arms
CAS4M24	21 1/4"	19 1/2"	37"	24 3/4"	•	
CAS4M30	21 1/4"	19 1/2"	42 3/4"	30 1/2"	•	
CAR4M24	21 1/4"	23 1/2"	37"	24 3/4"		•
CAR4M30	21 1/4"	23 1/2"	42 3/4"	30 1/2"		•

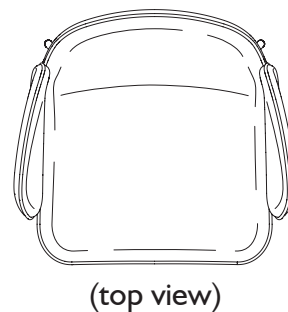
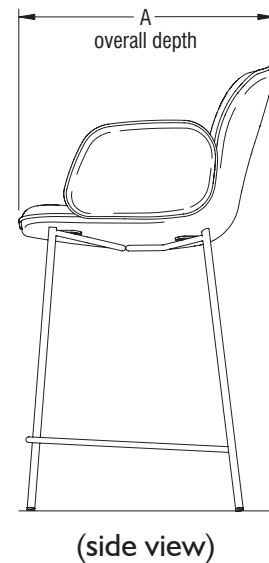
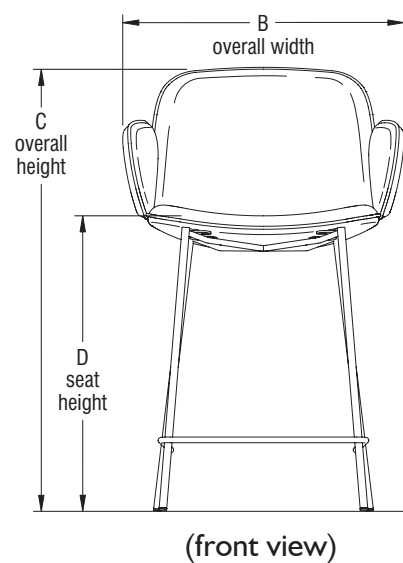

Cascha Metal Swivel Pedestal Base Stools - Adjustable-Height - (model CARPD shown)

Model Number	A Overall Depth	B Overall Width	C Overall Height	D Seat Height	Armless	With Arms
CASPD	21 1/4"	19 1/2"	32 1/4" - 41 3/4"	20" - 29 1/2"	•	
CARPD	21 1/4"	23 1/2"	32 1/4" - 41 3/4"	20" - 29 1/2"		•

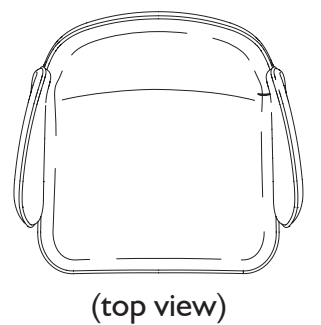
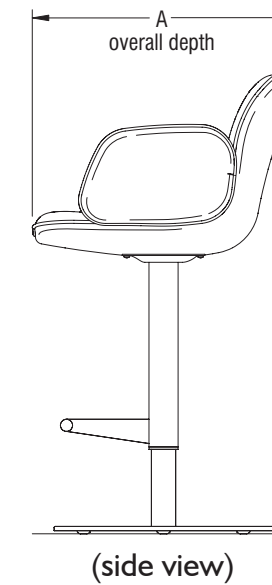
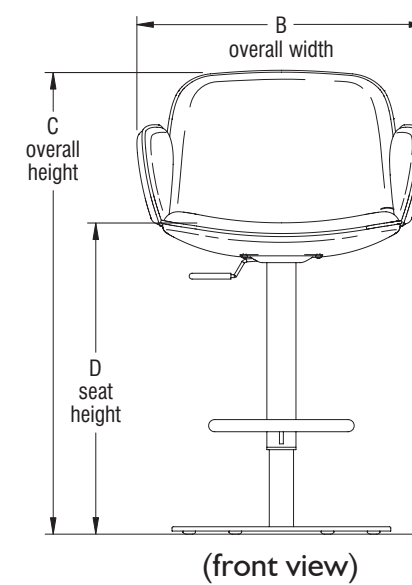

Cascha Wood 4-Leg Base Stools - (model CAR4W shown)

Model Number	A Overall Depth	B Overall Width	C Overall Height	D Seat Height	Armless	With Arms
CAS4W24	21 1/4"	19 1/2"	37"	24 3/4"	•	
CAS4W30	21 1/4"	19 1/2"	43"	30 3/4"	•	
CAR4W24	21 1/4"	23 1/2"	37"	24 3/4"		•
CAR4W30	21 1/4"	23 1/2"	43"	30 3/4"		•

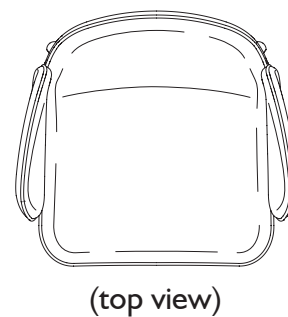
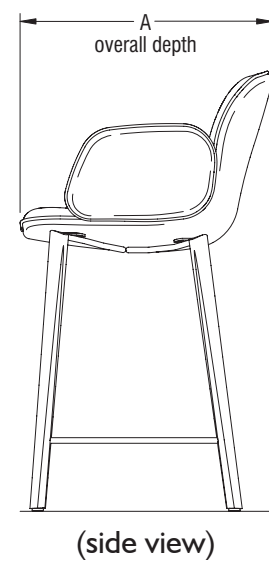
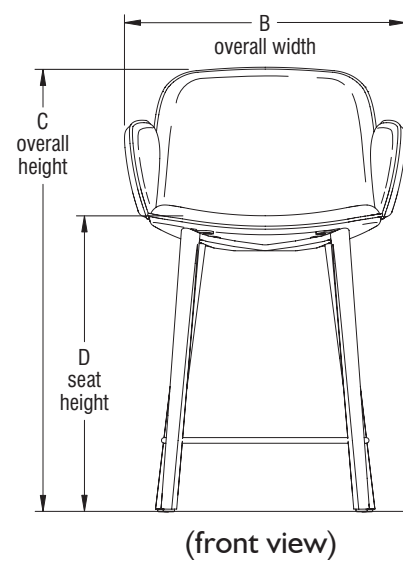

Cascha Table - (model CAM4K shown)

Model Number	A Overall Depth	B Overall Width	C Overall Height
CABXW16	25 3/4"	25 3/4"	16 1/4"
CABXW20	25 3/4"	25 3/4"	20 1/4"
CABXW29	25 3/4"	25 3/4"	29"
CABXW36	25 3/4"	25 3/4"	36"
CABXW42	25 3/4"	25 3/4"	42"

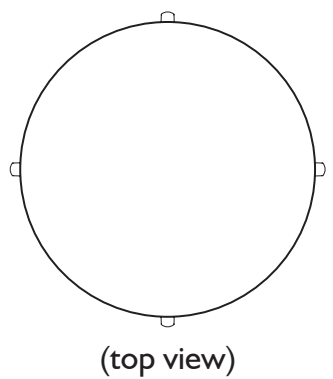
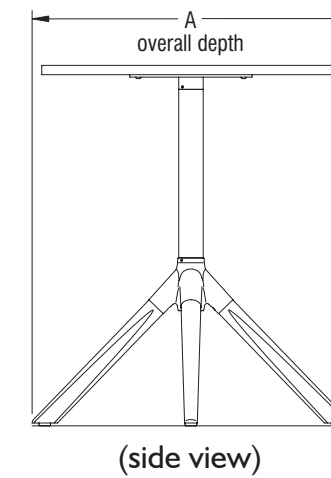
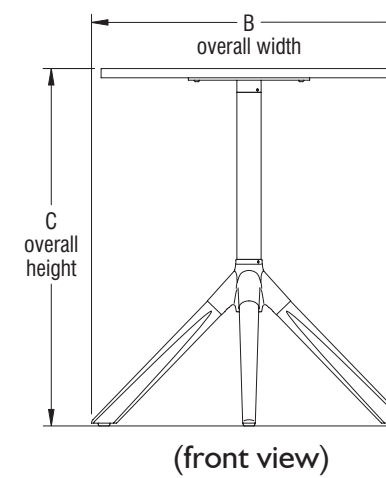



Cascha Lounge Chairs

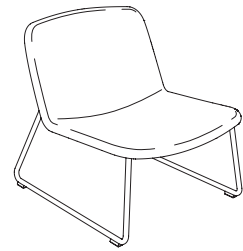

Sled Base
Non-Contrast
without Welting
CALSLNN

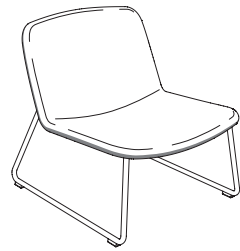

Sled Base
Contrast
without Welting
CALSLCN

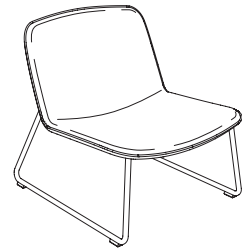

Sled Base
Non-Contrast
with Welting
CALSLNP

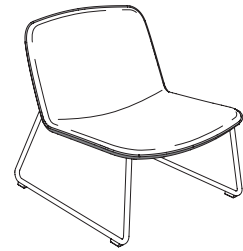

Sled Base
Contrast
with Welting
CALSLCP

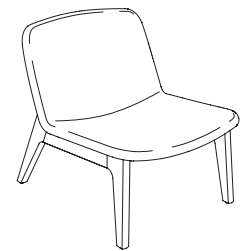

Wood Four-Leg Base
Non-Contrast
without Welting
CAL4WNN

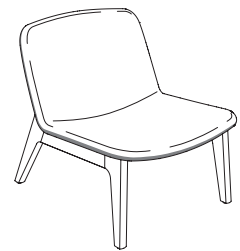

Wood Four-Leg Base
Contrast
without Welting
CAL4WCN

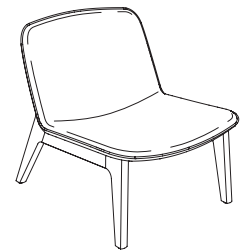

Wood Four-Leg Base
Non-Contrast
with Welting
CAL4WNP

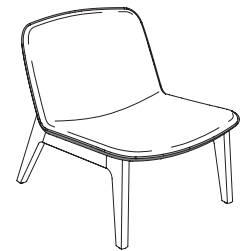

Wood Four-Leg Base
Contrast
with Welting
CAL4WCP



Metal Swivel Base with Casters
Non-Contrast
without Welting
CALSCNN



Metal Swivel Base with Casters
Contrast
without Welting
CALSCCN



Metal Swivel Base with Casters
Non-Contrast
with Welting
CALSCNP



Metal Swivel Base with Casters
Contrast
with Welting
CALSCCP



Metal Swivel Base with Glides
Non-Contrast
without Welting
CALSGNN



Metal Swivel Base with Glides
Contrast
without Welting
CALSGCN



Metal Swivel Base with Glides
Non-Contrast
with Welting
CALSGNP



Metal Swivel Base with Glides
Contrast
with Welting
CALSGCP

Cascha Lounge Chairs (cont.)

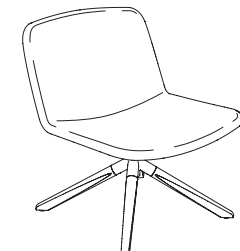

Wood Swivel Base
Non-Contrast
without Welting
CAL4KNN



Wood Swivel Base
Contrast
without Welting
CAL4KCN



Wood Swivel Base
Non-Contrast
with Welting
CAL4KNP



Wood Swivel Base
Contrast
with Welting
CAL4KCP

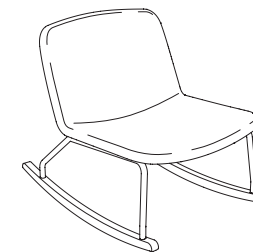

Rocking Base
Non-Contrast
without Welting
CALRWNN

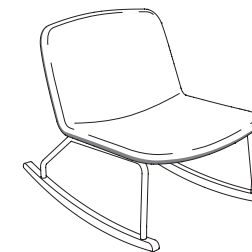

Rocking Base
Contrast
without Welting
CALRWCN

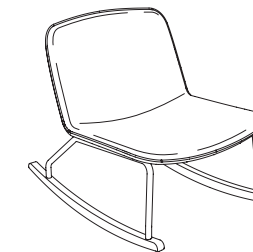

Rocking Base
Non-Contrast
with Welting
CALRWNP



Rocking Base
Contrast
with Welting
CALRWCP

Cascha Ottomans

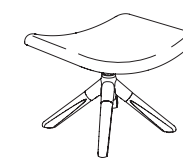

Wood Swivel Base
Non-Contrast
without Welting
CAF4KNN

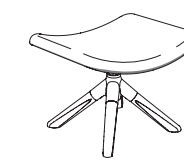

Wood Swivel Base
Contrast
without Welting
CAF4KCN

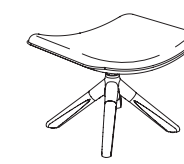

Wood Swivel Base
Non-Contrast
with Welting
CAF4KNP

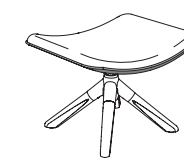

Wood Swivel Base
Contrast
with Welting
CAF4KCP

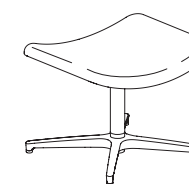

Metal Swivel Base
Non-Contrast
without Welting
CAFSGNN



Metal Swivel Base
Contrast
without Welting
CAFSGCN



Metal Swivel Base
Non-Contrast
with Welting
CAFSGNP



Metal Swivel Base
Contrast
with Welting
CAFSGCP



STATEMENT OF LINE

Cascha Guest Chairs (Armless)



Metal Four-Leg Base
 Non-Contrast
 without Welting
 CAG4MNN



Metal Four-Leg Base
 Contrast
 without Welting
 CAG4MCN

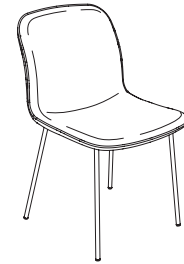

Metal Four-Leg Base
 Non-Contrast
 with Welting
 CAG4MNP



Metal Four-Leg Base
 Contrast
 with Welting
 CAG4MCP

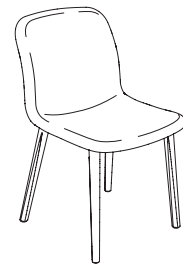

Wood Four-Leg Base
 Non-Contrast
 without Welting
 CAG4WNN



Wood Four-Leg Base
 Contrast
 without Welting
 CAG4WCN

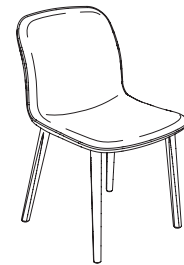

Wood Four-Leg Base
 Non-Contrast
 with Welting
 CAG4WNP

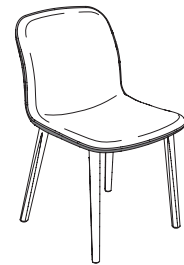

Wood Four-Leg Base
 Contrast
 with Welting
 CAG4WCP



Metal Swivel Base with Casters
 Non-Contrast
 without Welting
 CAG4CNN



Metal Swivel Base with Casters
 Contrast
 without Welting
 CAG4CCN



Metal Swivel Base with Casters
 Non-Contrast
 with Welting
 CAG4CNP



Metal Swivel Base with Casters
 Contrast
 with Welting
 CAG4CCP



Metal Swivel Base with Glides
 Non-Contrast
 without Welting
 CAG4GNN



Metal Swivel Base with Glides
 Contrast
 without Welting
 CAG4GCN



Metal Swivel Base with Glides
 Non-Contrast
 with Welting
 CAG4GNP



Metal Swivel Base with Glides
 Contrast
 with Welting
 CAG4GCP

STATEMENT OF LINE

Cascha Guest Chairs (Armless)

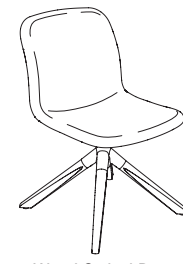

Wood Swivel Base
 Non-Contrast
 without Welting
 CAG4KNN

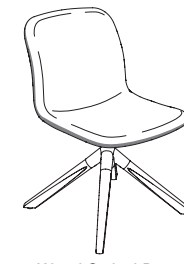

Wood Swivel Base
 Contrast
 without Welting
 CAG4KCN



Wood Swivel Base
 Non-Contrast
 with Welting
 CAG4KNP



Wood Swivel Base
 Contrast
 with Welting
 CAG4KCP

Cascha Guest Chairs (with Arms)



Metal Four-Leg Base
 Non-Contrast
 without Welting
 CAM4MNN



Metal Four-Leg Base
 Contrast
 without Welting
 CAM4MCN

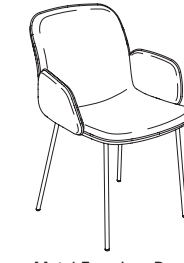

Metal Four-Leg Base
 Non-Contrast
 with Welting
 CAM4MNP

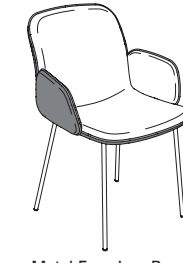

Metal Four-Leg Base
 Contrast
 with Welting
 CAM4MCP

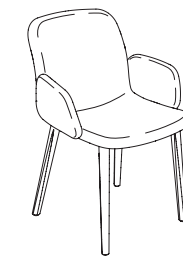

Wood Four-Leg Base
 without Welting
 CAM4WNN
 CAM4WCN

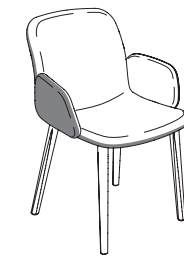

Wood Four-Leg Base
 Contrast
 without Welting
 CAM4WCN

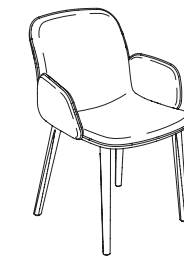

Wood Four-Leg Base
 with Welting
 CAM4WNP
 CAM4WCP

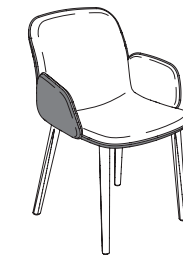

Wood Four-Leg Base
 Contrast
 with Welting
 CAM4WCP



Metal Swivel Base with Casters
 Non-Contrast
 without Welting
 CAM4CNN



Metal Swivel Base with Casters
 Contrast
 without Welting
 CAM4CCN



Metal Swivel Base with Casters
 Non-Contrast
 with Welting
 CAM4CNP



Metal Swivel Base with Casters
 Contrast
 with Welting
 CAM4CCP



STATEMENT OF LINE

Cascha Guest Chairs (with Arms) (cont.)



Metal Swivel Base with Glides
 Non-Contrast
 without Welting
 CAM4GNN



Metal Swivel Base with Glides
 Contrast
 without Welting
 CAM4GCN



Metal Swivel Base with Glides
 Non-Contrast
 with Welting
 CAM4GNP



Metal Swivel Base with Glides
 Contrast
 with Welting
 CAM4WCN



Wood Swivel Base
 Non-Contrast
 without Welting
 CAM4KNN



Wood Swivel Base
 Contrast
 without Welting
 CAM4KCN



Wood Swivel Base
 Non-Contrast
 with Welting
 CAM4KNP



Wood Swivel Base
 Contrast
 with Welting
 CAM4KCP

Cascha Stools (Armless)

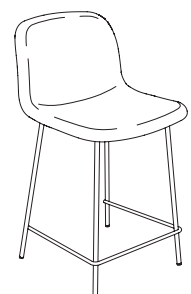

Metal Four-Leg Base
 24" High
 Non-Contrast
 without Welting
 CAS4MNN24



Metal Four-Leg Base
 24" High
 Contrast
 without Welting
 CAS4MCN24

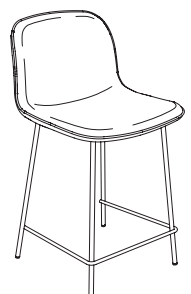

Metal Four-Leg Base
 24" High
 with Welting
 CAS4MNP24
 CAS4MCP24

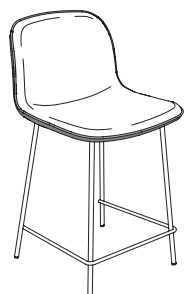

Metal Four-Leg Base
 24" High
 Contrast
 with Welting
 CAS4MCP24

Cascha Stools (Armless)

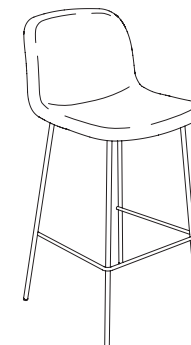

Metal Four-Leg Base
 30" High
 Non-Contrast
 without Welting
 CAS4MNN30



Metal Four-Leg Base
 30" High
 Contrast
 without Welting
 CAS4MCN30



Metal Four-Leg Base
 30" High
 Non-Contrast
 with Welting
 CAS4MNP30



Metal Four-Leg Base
 30" High
 Contrast
 with Welting
 CAS4MCP30



Wood Four-Leg Base
 24" High
 Non-Contrast
 without Welting
 CAS4WNN24



Wood Four-Leg Base
 24" High
 Contrast
 without Welting
 CAS4WCN24

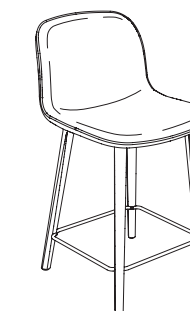

Wood Four-Leg Base
 24" High
 Non-Contrast
 with Welting
 CAS4WNP24



Wood Four-Leg Base
 24" High
 Contrast
 with Welting
 CAS4WCP24



Wood Four-Leg Base
 30" High
 Non-Contrast
 without Welting
 CAS4WNN30



Wood Four-Leg Base
 30" High
 Contrast
 without Welting
 CAS4WCN30



Wood Four-Leg Base
 30" High
 Non-Contrast
 with Welting
 CAS4WNP30



Wood Four-Leg Base
 30" High
 Contrast
 with Welting
 CAS4WCP30



STATEMENT OF LINE

Cascha Stools (Armless)



Metal Swivel Base
Adjustable-Height
Non-Contrast
without Welting
CASPDNN



Metal Swivel Base
Adjustable-Height
Contrast
without Welting
CASPCDN



Metal Swivel Base
Adjustable-Height
Non-Contrast
with Welting
CASPDNP



Metal Swivel Base
Adjustable-Height
Contrast
with Welting
CASPCDP

Cascha Stools (with Arms)

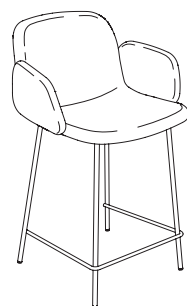

Metal Four-Leg Base
24" High
Non-Contrast
without Welting
CAR4MNN24



Metal Four-Leg Base
24" High
Contrast
without Welting
CAR4MCN24

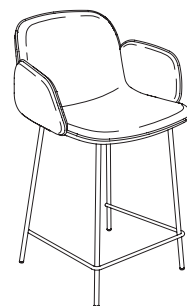

Metal Four-Leg Base
24" High
Non-Contrast
with Welting
CAR4MNP24

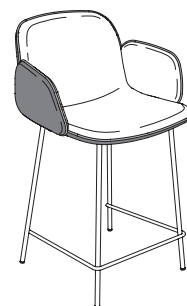

Metal Four-Leg Base
24" High
Contrast
with Welting
CAR4MCP24

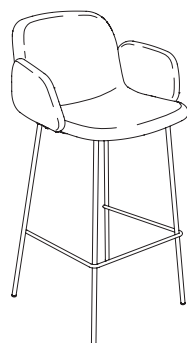

Metal Four-Leg Base
30" High
Non-Contrast
without Welting
CAR4MNN30



Metal Four-Leg Base
30" High
Contrast
without Welting
CAR4MCN30



Metal Four-Leg Base
30" High
Non-Contrast
with Welting
CAR4MNP30

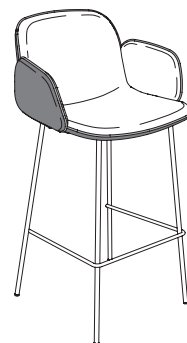

Metal Four-Leg Base
30" High
Contrast
with Welting
CAR4MCP30

STATEMENT OF LINE

Cascha Stools (with Arms) (cont.)

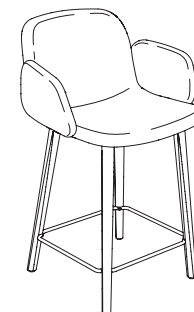

Wood Four-Leg Base
24" High
Non-Contrast
without Welting
CAR4WNN24



Wood Four-Leg Base
24" High
Contrast
without Welting
CAR4WCN24

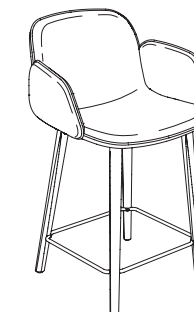

Wood Four-Leg Base
24" High
Non-Contrast
with Welting
CAR4WNP24



Wood Four-Leg Base
24" High
Contrast
with Welting
CAR4WCP24



Wood Four-Leg Base
30" High
Non-Contrast
without Welting
CAR4WNN30



Wood Four-Leg Base
30" High
Contrast
without Welting
CAR4WCN30



Wood Four-Leg Base
30" High
Non-Contrast
with Welting
CAR4WNP30

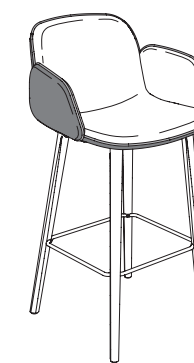

Wood Four-Leg Base
30" High
Contrast
with Welting
CAR4WCP30



Metal Swivel Base
Adjustable-Height
Non-Contrast
without Welting
CARPDNN



Metal Swivel Base
Adjustable-Height
Contrast
without Welting
CARPCDN



Metal Swivel Base
Adjustable-Height
Non-Contrast
with Welting
CARPDNP



Metal Swivel Base
Adjustable-Height
Contrast
with Welting
CARPCDP



STATEMENT OF LINE

Cascha Tables

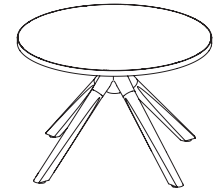

Coffee Table
Wood Base
16" High
CABXW16

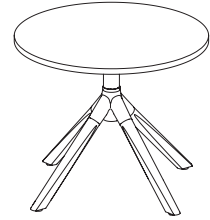

Side Table
Wood Base
20" High
CABXW20

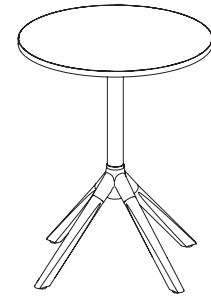

Standard Height Table
Wood Base
29" High
CABXW29

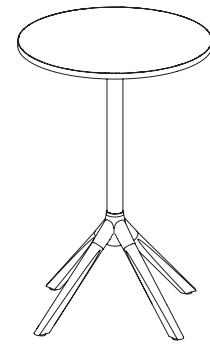

Counter Height Table
Wood Base
36" High
CABXW36

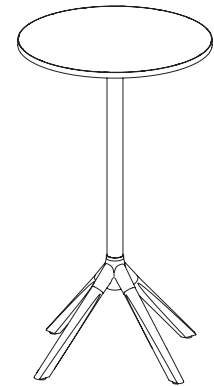

Café Height Table
Wood Base
42" High
CABXW42



Wood Finish

Eclipse Black on Ash	AEB
Natural on Ash	ANA
River Cherry on Ash	ARY

Metal Finish

Black	BL
Cool Grey	CG
Cottonwood	CO
Warm Grey	WG
Polished Aluminum	PA

*NOTE: Metal finish options vary by product.

Edge Color

Akira	EAK
Beigewood	EBZ
Belair	EBQ
Biltmore Cherry	EBT
Black	EBL
Black Hills Oak	EBH
Blue Grey	EGR
Brighton Walnut	EBW
Castle Oak	ECO
Cayenne	ECY
Cherry Storm	ECX
Cocobala	ECC
Cool Grey	ECG
Cumberland Walnut	ECJ
Dering Forest	EDF
Designer White	EDR
Everglade Shade	EEV
Fawn Cypress	EFQ
Flannel	EFN
Florence Walnut	EFC
Friston Ash	EFH
Frosty White	EFW
Hartley Walnut	EHW
Hazy Jade	EHJ
Italian Silver Ash	EIT
Kensington Maple	EKM
Light Tone	ELG
Mardi Gras	EMG
Misty Brown	EMY
Monticello Maple	EMT
Multiplex	EMB
Nemo	ENE
Nordic	END
Pinnacle Walnut	EPW
Poppy Red	EPR
Rainforest	ERQ
Raleigh Walnut	ERW
River Cherry	ERY
Rubber Ducky	ERK
Sand	ESA
Sky Blue	ESK
Solano Walnut	ESG
Sterling Ash	EAZ

Surf's Up
Tarragon
Twilight Shadow
Ultra Blue
Valley Forge Elm
Warm Grey
White River Forest
Windsor Mahogany
Zesty Lime

Surface Finish--Grade 1 Standard Laminate

Beigewood
Belair
Biltmore Cherry
Black
Brighton Walnut
Castle Oak
Cherry Storm
Classic Linen
Cocobala
Crisp Linen
Designer White
Dove Grey
Florence Walnut
Friston Ash
Frosty White
Graphite Nebula
Grey
High Rise
Hollyberry
Island
Italian Silver Ash
Kensington Maple
Lapis Blue
Monticello Maple
North Sea
Ocean
Pinnacle Walnut
River Cherry
Shadow Zephyr
Sterling Ash
Titanium Evolv
White Nebula
White Sand
Windsor Mahogany

Surface Finish--Grade 2 Standard Laminate

Akira
Black Alicante
Black Hills Oak
Calcutta Marble
Dering Forest
Fawn Cypress
Ice Mist
Markerboard White
Valley Forge Elm
White River Forest

Surface Finish--Grade 3 Standard Laminate

Black Velvet	LBV
Cumberland Walnut	LCJ
Designer White Velvet	LDE
Hartley Walnut	LHW
Nile Velvet	LNL
Raleigh Walnut	LRW
Solano Walnut	LSG
Spruce Velvet	LSC

Welting Color

Craft Ash	WTCTAH
Craft Cape	WTCTCE
Craft Cerulean	WTCTCN
Craft Chalk	WTCTCK
Craft Charcoal	WTCTCL
Craft Coral	WTCTCA
Craft Delft	WTCTDT
Craft Dew	WTCTDW
Craft Fog	WTCTFG
Craft Herb	WTCTHB
Craft Island	WTCTID
Craft Lead	WTCTLD
Craft Lemonade	WTCTLE
Craft Mist	WTCTMT
Craft Papaya	WTCTPA
Craft Prima	WTCTPM
Craft Seaport	WTCTST
Craft Silk	WTCTSK
Craft Soot	WTCTSO
Craft Spice	WTCTSE
Craft Terra	WTCTTA
Craft Willow	WTCTWW
Sandstone Alloy	WTSEAY
Sandstone Amethyst	WTSEAT
Sandstone Andesine	WTSEAE
Sandstone Antelope	WTSEAP
Sandstone Aquamarine	WTSEAN
Sandstone Atoll	WTSEAO
Sandstone Aura	WTSEAA
Sandstone Quiet	WTSEQT
Sandstone Balin	WTSEBN
Sandstone Bark	WTSEBK
Sandstone Eclipse	WTSEEE
Sandstone Fauve	WTSEFE
Sandstone Foam	WTSEFM
Sandstone Inkling	WTSEIG
Sandstone Kaitoke	WTSEKE
Sandstone Kelp	WTSEKP
Sandstone Mist	WTSEMT
Sandstone Obsidian	WTSEON
Sandstone Onyx	WTSEOX
Sandstone Parchment	WTSEPT
Sandstone Patriot	WTSEPO
Sandstone Ruby	WTSERY
Sandstone Seaborne	WTSESE
Sandstone Sienna	WTSESA
Sandstone Slate	WTSEST

Sandstone Squall	WTSESL
Sandstone Tanzanite	WTSETE
Sandstone Taupe	WTSETP
Sandstone Varsity	WTSEVY
Sandstone Wheat	WTSEWT

Finish Cards

View color swatches for items listed within this document.

Paints

Plastics/Poly

Wood/Veneer

Laminates

Molded Edges

Edge Styles

Hard Plastics

Glass

Certain options referenced may not be available on GSA Schedule.



Cascha™ Lounge Seating

Lounge Chair, Armless, Sled Base



Cascha™ Lounge Seating

Lounge Chair, Armless, Sled Base

MODEL	MODEL NUMBER				Approx. Packaged Weight	Delivered Pricing
	Basic Model	Non-Contrast or Fabric Contrast 1	Fabric Contrast 2	Metal Finish		
 <p>Lounge Chair, Armless, Sled Base, Non-Contrast</p> <ul style="list-style-type: none"> Fully upholstered with steel sled base Fixed height Non-contrast C.O.M = 2.5 yds Overall Dimensions: W=26.5" D=30.75" H=29.25" 	CALSINN	<input type="checkbox"/> <input type="checkbox"/> <input type="checkbox"/> <input type="checkbox"/>		<input type="checkbox"/> <input type="checkbox"/>	38.00#	\$ 1160
CALS						
 <p>Lounge Chair, Armless, Sled Base, Contrast</p> <ul style="list-style-type: none"> Fully upholstered with steel sled base Fixed height 1 = Top of Seat & Inside Back (Fabric Contrast 1) C.O.M. = 1.25 yds 2 = Bottom of Seat & Outside Back (Fabric Contrast 2) C.O.M. = 1.25 yds Overall Dimensions: W=26.5" D=30.75" H=29.25" 	CALSNCN	<input type="checkbox"/> <input type="checkbox"/> <input type="checkbox"/> <input type="checkbox"/>	<input type="checkbox"/> <input type="checkbox"/> <input type="checkbox"/> <input type="checkbox"/>	<input type="checkbox"/> <input type="checkbox"/>	38.00#	\$ 1190
CALS						
	A	B	C	D		

HOW TO ORDER

Indicate the following information on order form:

- Quantity of each item.
- Model number, including options. See "How To Build a Model Number".
- Any special service required.

Note: • The indicates that a choice is required.

- The absence of the indicates that no choice is required.
- Alpha-numeric characters in place of indicate that no other alternatives are available.

HOW TO BUILD A MODEL NUMBER

- A** Select basic model.
- B** Select non-contrast or fabric contrast 1.
Refer to ki.com/fabrics.
• For yardage pricing, see Fabric Yardage Pricing page
- C** Select fabric contrast 2.
Refer to ki.com/fabrics.
• For yardage pricing, see Fabric Yardage Pricing page
- D** Select metal finish.
- | | |
|-----------|--------------|
| BL | - Black |
| CH | - Chrome |
| CG | - Cool Grey |
| CO | - Cottonwood |
| WG | - Warm Grey |
- Refer to the **Product Color Options** page in this price list.

SPECIAL SERVICES

Special Carton Marking

With specially marked information N/C

Shipping

Ships **assembled, FOB Sheboygan, WI 53081, freight prepaid.** Freight class 300.

Specifications and prices are subject to change without prior notice.



Cascha™ Lounge Seating

Lounge Chair, Armless, Sled Base, With Welting



Cascha™ Lounge Seating

Lounge Chair, Armless, Sled Base, With Welting

MODEL	MODEL NUMBER					Approx. Packaged Weight	Delivered Pricing
	Basic Model	Non-Contrast or Fabric Contrast 1	Fabric Contrast 2	Welting Color	Metal Finish		
 <p>Lounge Chair, Armless, Sled Base, Non-Contrast, With Welting</p> <ul style="list-style-type: none"> Fully upholstered with steel sled base Includes 0.25" contrasting perimeter welt Fixed height Non-contrast C.O.M = 2.5 yds Overall Dimensions: W=26.5" D=30.75" H=29.25" 	CALS LNP	<input type="checkbox"/> <input type="checkbox"/> <input type="checkbox"/> <input type="checkbox"/>		<input type="checkbox"/> <input type="checkbox"/> <input type="checkbox"/> <input type="checkbox"/>	<input type="checkbox"/> <input type="checkbox"/>	38.00#	\$ 1280
CALS L							
 <p>Lounge Chair, Armless, Sled Base, Contrast, With Welting</p> <ul style="list-style-type: none"> Fully upholstered with steel sled base Includes 0.25" contrasting perimeter welt Fixed height 1 = Top of Seat & Inside Back (Fabric Contrast 1) C.O.M. = 1.25 yds 2 = Bottom of Seat & Outside Back (Fabric Contrast 2) C.O.M. = 1.25 yds Overall Dimensions: W=26.5" D=30.75" H=29.25" 	CALS LCP	<input type="checkbox"/> <input type="checkbox"/> <input type="checkbox"/> <input type="checkbox"/>	<input type="checkbox"/> <input type="checkbox"/> <input type="checkbox"/> <input type="checkbox"/>	<input type="checkbox"/> <input type="checkbox"/> <input type="checkbox"/> <input type="checkbox"/>	<input type="checkbox"/> <input type="checkbox"/>	38.00#	\$ 1310
CALS L							
		A	B	C	D	E	

HOW TO ORDER

Indicate the following information on order form:

- Quantity of each item.
- Model number, including options. See "How To Build a Model Number".
- Any special service required.

Note: • The indicates that a choice is required.

- The absence of the indicates that no choice is required.
- Alpha-numeric characters in place of indicate that no other alternatives are available.

HOW TO BUILD A MODEL NUMBER

- A** Select basic model.
- B** Select non-contrast or fabric contrast 1.
Refer to ki.com/fabrics.
• For yardage pricing, see Fabric Yardage Pricing page
- C** Select fabric contrast 2.
Refer to ki.com/fabrics.
• For yardage pricing, see Fabric Yardage Pricing page
- D** Select welting color.
Refer to the **Product Color Options** page in this price list.
- E** Select metal finish.
- | | |
|-----------|--------------|
| BL | - Black |
| CH | - Chrome |
| CG | - Cool Grey |
| CO | - Cottonwood |
| WG | - Warm Grey |
- Refer to the **Product Color Options** page in this price list.

SPECIAL SERVICES

Special Carton Marking

With specially marked information N/C

Shipping

Ships **assembled, FOB Sheboygan, WI 53081, freight prepaid**. Freight class 300.

Specifications and prices are subject to change without prior notice.

Cascha™ Lounge Seating

Lounge Chair, Armless, Wood Four-Leg Base



Cascha™ Lounge Seating

Lounge Chair, Armless, Wood Four-Leg Base

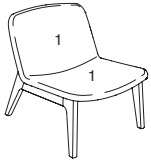
MODEL	MODEL NUMBER					Approx. Packaged Weight	Delivered Pricing
	Basic Model	Non-Contrast or Fabric Contrast 1	Fabric Contrast 2	Wood Finish	Glide Option		
 <p>Lounge Chair, Armless, Wood Four-Leg Base, Non-Contrast</p> <ul style="list-style-type: none"> Fully upholstered with ash wood legs Fixed height Non-contrast C.O.M = 2.5 yds Overall Dimensions: W=26.5" D=30.5" H=29" 	CAL4WNN	<input type="checkbox"/> <input type="checkbox"/> <input type="checkbox"/> <input type="checkbox"/>		<input type="checkbox"/> <input type="checkbox"/> <input type="checkbox"/>	<input type="checkbox"/> <input type="checkbox"/> <input type="checkbox"/>	42.00#	\$ 1365
CAL4W							
 <p>Lounge Chair, Armless, Wood Four-Leg Base, Contrast</p> <ul style="list-style-type: none"> Fully upholstered with ash wood legs Fixed height 1 = Top of Seat & Inside Back (Fabric Contrast 1) C.O.M. = 1.25 yds 2 = Bottom of Seat & Outside Back (Fabric Contrast 2) C.O.M. = 1.25 yds Overall Dimensions: W=26.5" D=30.5" H=29" 	CAL4WCN	<input type="checkbox"/> <input type="checkbox"/> <input type="checkbox"/> <input type="checkbox"/>	<input type="checkbox"/> <input type="checkbox"/> <input type="checkbox"/> <input type="checkbox"/>	<input type="checkbox"/> <input type="checkbox"/> <input type="checkbox"/>	<input type="checkbox"/> <input type="checkbox"/> <input type="checkbox"/>	42.00#	\$ 1395
CAL4W							
	A	B	C	D	E		

HOW TO ORDER

Indicate the following information on order form:

- Quantity of each item.
- Model number, including options. See "How To Build a Model Number".
- Any special service required.

Note: • The indicates that a choice is required.

- The absence of the indicates that no choice is required.
- Alpha-numeric characters in place of indicate that no other alternatives are available.

HOW TO BUILD A MODEL NUMBER

- A** Select basic model.
- B** Select non-contrast or fabric contrast 1.
Refer to ki.com/fabrics.
• For yardage pricing, see Fabric Yardage Pricing page
- C** Select fabric contrast 2.
Refer to ki.com/fabrics.
• For yardage pricing, see Fabric Yardage Pricing page
- D** Select wood finish.
- | | |
|------------|------------------------|
| AEB | - Eclipse Black on Ash |
| ANA | - Natural on Ash |
| ARY | - River Cherry on Ash |
- Refer to the **Product Color Options** page in this price list.
- E** Select glide option.
- | | |
|------------|--------------------------|
| GFT | - Felt glides; add \$16 |
| GNY | - Nylon glides; add \$16 |
| GNN | - No glides |

SPECIAL SERVICES

Special Carton Marking

With specially marked information N/C

Shipping

Ships **assembled, FOB Sheboygan, WI 53081, freight prepaid.** Freight class 300.

Specifications and prices are subject to change without prior notice.

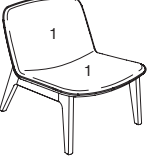

MODEL	MODEL NUMBER						Approx. Packaged Weight	Delivered Pricing
	Basic Model	Non-Contrast or Fabric Contrast 1	Fabric Contrast 2	Welting Color	Wood Finish	Glide Option		
 CAL4W Lounge Chair, Armless, Wood Four-Leg Base, Non-Contrast, With Welting • Fully upholstered with ash wood legs • Includes 0.25" contrasting perimeter welt • Fixed height • Non-contrast C.O.M = 2.5 yds • Overall Dimensions: W=26.5" D=30.5" H=29"	CAL4WNP	<input type="checkbox"/> <input type="checkbox"/> <input type="checkbox"/> <input type="checkbox"/>		<input type="checkbox"/> <input type="checkbox"/> <input type="checkbox"/> <input type="checkbox"/>	<input type="checkbox"/> <input type="checkbox"/>	<input type="checkbox"/> <input type="checkbox"/>	42.00#	\$ 1485
 CAL4W Lounge Chair, Armless, Wood Four-Leg Base, Contrast, With Welting • Fully upholstered with ash wood legs • Includes 0.25" contrasting perimeter welt • Fixed height • 1 = Top of Seat & Inside Back (Fabric Contrast 1) C.O.M. = 1.25 yds • 2 = Bottom of Seat & Outside Back (Fabric Contrast 2) C.O.M. = 1.25 yds • Overall Dimensions: W=26.5" D=30.5" H=29"	CAL4WCP	<input type="checkbox"/> <input type="checkbox"/> <input type="checkbox"/> <input type="checkbox"/>	<input type="checkbox"/> <input type="checkbox"/> <input type="checkbox"/> <input type="checkbox"/>	<input type="checkbox"/> <input type="checkbox"/> <input type="checkbox"/> <input type="checkbox"/>	<input type="checkbox"/> <input type="checkbox"/>	<input type="checkbox"/> <input type="checkbox"/>	42.00#	\$ 1515

A **B** **C** **D** **E** **F**

HOW TO ORDER

- Indicate the following information on order form:
- Quantity of each item.
 - Model number, including options. See "How to Build a Model Number".
 - Any special service required.

Note: • The indicates that a choice is required.
 • The absence of the indicates that no choice is required.
 • Alpha-numeric characters in place of indicate that no other alternatives are available.

HOW TO BUILD A MODEL NUMBER

- A** Select basic model.
- B** Select non-contrast or fabric contrast 1. Refer to ki.com/fabrics.
 • For yardage pricing, see Fabric Yardage Pricing page
- C** Select fabric contrast 2. Refer to ki.com/fabrics.
 • For yardage pricing, see Fabric Yardage Pricing page
- D** Select welting color. Refer to the **Product Color Options** page in this price list.
- E** Select wood finish.

AEB	- Eclipse Black on Ash
ANA	- Natural on Ash
ARY	- River Cherry on Ash

 Refer to the **Product Color Options** page in this price list.

- F** Select glide option.

GFT	- Felt glides; add \$16
GNY	- Nylon glides; add \$16
GNN	- No glides

SPECIAL SERVICES

Special Carton Marking

With specially marked information N/C

Shipping

Ships assembled, FOB Sheboygan, WI 53081, freight prepaid. Freight class 300.

Specifications and prices are subject to change without prior notice.



Cascha™ Lounge Seating

Lounge Chair, Armless, Metal Swivel Base with Casters



Cascha™ Lounge Seating

Lounge Chair, Armless, Metal Swivel Base with Casters

MODEL	MODEL NUMBER				Approx. Packaged Weight	Delivered Pricing
	Basic Model	Non-Contrast or Fabric Contrast 1	Fabric Contrast 2	Metal Finish		
 <p>Lounge Chair, Armless, Metal Swivel Base with Casters, Non-Contrast</p> <ul style="list-style-type: none"> Fully upholstered with aluminum swivel base on casters Fixed height Non-contrast C.O.M = 2.5 yds Overall Dimensions: W=26.5" D=28.75" H=33.5" 	CALSCNN	<input type="checkbox"/> <input type="checkbox"/> <input type="checkbox"/> <input type="checkbox"/>		<input type="checkbox"/> <input type="checkbox"/>	39.00#	\$ 1245
CALSC						
 <p>Lounge Chair, Armless, Metal Swivel Base with Casters, Contrast</p> <ul style="list-style-type: none"> Fully upholstered with aluminum swivel base on casters Fixed height 1 = Top of Seat & Inside Back (Fabric Contrast 1) C.O.M. = 1.25 yds 2 = Bottom of Seat & Outside Back (Fabric Contrast 2) C.O.M. = 1.25 yds Overall Dimensions: W=26.5" D=28.75" H=33.5" 	CALSCCN	<input type="checkbox"/> <input type="checkbox"/> <input type="checkbox"/> <input type="checkbox"/>	<input type="checkbox"/> <input type="checkbox"/> <input type="checkbox"/> <input type="checkbox"/>	<input type="checkbox"/> <input type="checkbox"/>	39.00#	\$ 1275
CALSC						
	A	B	C	D		

HOW TO ORDER

Indicate the following information on order form:

- Quantity of each item.
- Model number, including options. See "How To Build a Model Number".
- Any special service required.

Note: • The indicates that a choice is required.

- The absence of the indicates that no choice is required.
- Alpha-numeric characters in place of indicate that no other alternatives are available.

HOW TO BUILD A MODEL NUMBER

- A** Select basic model.
- B** Select non-contrast or fabric contrast 1.
Refer to ki.com/fabrics.
• For yardage pricing, see Fabric Yardage Pricing page
- C** Select fabric contrast 2.
Refer to ki.com/fabrics.
• For yardage pricing, see Fabric Yardage Pricing page
- D** Select metal finish.
BL - Black
PA - Polished Aluminum
Refer to the **Product Color Options** page in this price list.

SPECIAL SERVICES

Special Carton Marking

With specially marked information N/C

Shipping

Ships assembled, FOB Sheboygan, WI 53081, freight prepaid. Freight class 300.

Specifications and prices are subject to change without prior notice.



Cascha™ Lounge Seating

Lounge Chair, Armless, Metal Swivel Base with Casters, With Welting



Cascha™ Lounge Seating

Lounge Chair, Armless, Metal Swivel Base with Casters, With Welting

MODEL	MODEL NUMBER				Approx. Packaged Weight	Delivered Pricing
	Basic Model	Non-Contrast or Fabric Contrast 1	Welting Color	Metal Finish		
 <p>CALSC</p> <p>Lounge Chair, Armless, Metal Swivel Base with Casters, Non-Contrast, With Welting</p> <ul style="list-style-type: none"> Fully upholstered with aluminum swivel base on casters Includes 0.25" contrasting perimeter welt Fixed height Non-contrast C.O.M = 2.5 yds Overall Dimensions: W=26.5" D=28.75" H=33.5" 	CALSCNP	□□□□	□□□□	□□	39.00#	\$ 1365
 <p>CALSC</p> <p>Lounge Chair, Armless, Metal Swivel Base with Casters, Contrast, With Welting</p> <ul style="list-style-type: none"> Fully upholstered with aluminum swivel base on casters Includes 0.25" contrasting perimeter welt Fixed height 1 = Top of Seat & Inside Back (Fabric Contrast 1) C.O.M. = 1.25 yds 2 = Bottom of Seat & Outside Back (Fabric Contrast 2) C.O.M. = 1.25 yds Overall Dimensions: W=26.5" D=28.75" H=33.5" 	CALSCCP	□□□□	□□□□	□□	39.00#	\$ 1395
	A	B	C	D		

HOW TO ORDER

Indicate the following information on order form:

- Quantity of each item.
- Model number, including options. See "How To Build a Model Number".
- Any special service required.

Note: • The indicates that a choice is required.

- The absence of the indicates that no choice is required.
- Alpha-numeric characters in place of indicate that no other alternatives are available.

HOW TO BUILD A MODEL NUMBER

- A** Select basic model.
- B** Select non-contrast or fabric contrast 1.
Refer to ki.com/fabrics.
• For yardage pricing, see Fabric Yardage Pricing page
- C** Select welting color.
Refer to the **Product Color Options** page in this price list.
- D** Select metal finish.
BL - Black
PA - Polished Aluminum
Refer to the **Product Color Options** page in this price list.

SPECIAL SERVICES

Special Carton Marking

With specially marked information N/C

Shipping

Ships assembled, FOB Sheboygan, WI 53081, freight prepaid. Freight class 300.

Specifications and prices are subject to change without prior notice.



Cascha™ Lounge Seating

Lounge Chair, Armless, Metal Swivel Base



Cascha™ Lounge Seating

Lounge Chair, Armless, Metal Swivel Base

MODEL	MODEL NUMBER					Approx. Packaged Weight	Delivered Pricing
	Basic Model	Non-Contrast or Fabric Contrast 1	Fabric Contrast 2	Metal Finish	Glide Option		
 <p>Lounge Chair, Armless, Metal Swivel Base, Non-Contrast</p> <ul style="list-style-type: none"> Fully upholstered with aluminum swivel base Fixed height Non-contrast C.O.M = 2.5 yds Overall Dimensions: W=26.5" D=28.75" H=31.75" 	CALSGNN	<input type="checkbox"/> <input type="checkbox"/> <input type="checkbox"/> <input type="checkbox"/>		<input type="checkbox"/> <input type="checkbox"/>	<input type="checkbox"/> <input type="checkbox"/>	40.00#	\$ 1210
CALSG							
 <p>Lounge Chair, Armless, Metal Swivel Base, Contrast</p> <ul style="list-style-type: none"> Fully upholstered with aluminum swivel base Fixed height 1 = Top of Seat & Inside Back (Fabric Contrast 1) C.O.M. = 1.25 yds 2 = Bottom of Seat & Outside Back (Fabric Contrast 2) C.O.M. = 1.25 yds Overall Dimensions: W=26.5" D=28.75" H=31.75" 	CALSGCN	<input type="checkbox"/> <input type="checkbox"/> <input type="checkbox"/> <input type="checkbox"/>	<input type="checkbox"/> <input type="checkbox"/> <input type="checkbox"/> <input type="checkbox"/>	<input type="checkbox"/> <input type="checkbox"/>	<input type="checkbox"/> <input type="checkbox"/>	40.00#	\$ 1240
CALSG							
		A	B	C	D	E	

HOW TO ORDER

Indicate the following information on order form:

- Quantity of each item.
- Model number, including options. See "How To Build a Model Number".
- Any special service required.

Note: • The indicates that a choice is required.

- The absence of the indicates that no choice is required.
- Alpha-numeric characters in place of indicate that no other alternatives are available.

HOW TO BUILD A MODEL NUMBER

- A** Select basic model.
- B** Select non-contrast or fabric contrast 1.
Refer to ki.com/fabrics.
• For yardage pricing, see Fabric Yardage Pricing page
- C** Select fabric contrast 2.
Refer to ki.com/fabrics.
• For yardage pricing, see Fabric Yardage Pricing page
- D** Select metal finish.
BL - Black
PA - Polished Aluminum
Refer to the **Product Color Options** page in this price list.
- E** Select glide option.
GFT - Felt glides
GNV - Nylon glides

SPECIAL SERVICES

Special Carton Marking

With specially marked information N/C

Shipping

Ships **assembled, FOB Sheboygan, WI 53081, freight prepaid.** Freight class 300.

Specifications and prices are subject to change without prior notice.



Cascha™ Lounge Seating

Lounge Chair, Armless, Metal Swivel Base, With Welting



Cascha™ Lounge Seating

Lounge Chair, Armless, Metal Swivel Base, With Welting

MODEL	MODEL NUMBER						Approx. Packaged Weight	Delivered Pricing
	Basic Model	Non-Contrast or Fabric Contrast 1	Fabric Contrast 2	Welting Color	Metal Finish	Glide Option		
 CALSG	CALSGNP	<input type="checkbox"/> <input type="checkbox"/> <input type="checkbox"/> <input type="checkbox"/>		<input type="checkbox"/> <input type="checkbox"/> <input type="checkbox"/> <input type="checkbox"/>	<input type="checkbox"/> <input type="checkbox"/>	<input type="checkbox"/> <input type="checkbox"/>	40.00#	\$ 1330
 CALSG	CALSGCP	<input type="checkbox"/> <input type="checkbox"/> <input type="checkbox"/> <input type="checkbox"/>	<input type="checkbox"/> <input type="checkbox"/> <input type="checkbox"/> <input type="checkbox"/>	<input type="checkbox"/> <input type="checkbox"/> <input type="checkbox"/> <input type="checkbox"/>	<input type="checkbox"/> <input type="checkbox"/>	<input type="checkbox"/> <input type="checkbox"/>	40.00#	\$ 1360

A **B** **C** **D** **E** **F**

HOW TO ORDER

Indicate the following information on order form:

- Quantity of each item.
- Model number, including options. See "How To Build a Model Number".
- Any special service required.

Note: • The indicates that a choice is required.

- The absence of the indicates that no choice is required.
- Alpha-numeric characters in place of indicate that no other alternatives are available.

HOW TO BUILD A MODEL NUMBER

A Select basic model.

B Select non-contrast or fabric contrast 1.
Refer to ki.com/fabrics.
• For yardage pricing, see Fabric Yardage Pricing page

C Select fabric contrast 2.
Refer to ki.com/fabrics.
• For yardage pricing, see Fabric Yardage Pricing page

D Select welting color.
Refer to the **Product Color Options** page in this price list.

E Select metal finish.
BL - Black
PA - Polished Aluminum
Refer to the **Product Color Options** page in this price list.

F Select glide option.
GFT - Felt glides
GNV - Nylon glides

SPECIAL SERVICES

Special Carton Marking

With specially marked information N/C

Shipping

Ships **assembled, FOB Sheboygan, WI 53081, freight prepaid.** Freight class 300.

Specifications and prices are subject to change without prior notice.



Cascha™ Lounge Seating

Lounge Chair, Armless, Wood Swivel Base



Cascha™ Lounge Seating

Lounge Chair, Armless, Wood Swivel Base

MODEL	MODEL NUMBER					Approx. Packaged Weight	Delivered Pricing
	Basic Model	Non-Contrast or Fabric Contrast 1	Fabric Contrast 2	Wood Finish	Glide Option		
 <p>Lounge Chair, Armless, Wood Swivel Base, Non-Contrast</p> <ul style="list-style-type: none"> Fully upholstered with ash wood & steel swivel base Fixed height Non-contrast C.O.M = 2.5 yds Overall Dimensions: W=26.5" D=28.5" H=32.25" 	CAL4KNN	<input type="checkbox"/> <input type="checkbox"/> <input type="checkbox"/> <input type="checkbox"/>		<input type="checkbox"/> <input type="checkbox"/>	<input type="checkbox"/> <input type="checkbox"/>	38.00#	\$ 1470
CAL4K							
 <p>Lounge Chair, Armless, Wood Swivel Base, Contrast</p> <ul style="list-style-type: none"> Fully upholstered with ash wood & steel swivel base Fixed height 1 = Top of Seat & Inside Back (Fabric Contrast 1) C.O.M. = 1.25 yds 2 = Bottom of Seat & Outside Back (Fabric Contrast 2) C.O.M. = 1.25 yds Overall Dimensions: W=26.5" D=28.5" H=32.25" 	CAL4KCN	<input type="checkbox"/> <input type="checkbox"/> <input type="checkbox"/> <input type="checkbox"/>	<input type="checkbox"/> <input type="checkbox"/> <input type="checkbox"/> <input type="checkbox"/>	<input type="checkbox"/> <input type="checkbox"/>	<input type="checkbox"/> <input type="checkbox"/>	38.00#	\$ 1500
CAL4K							
	A	B	C	D	E		

HOW TO ORDER

Indicate the following information on order form:

- Quantity of each item.
- Model number, including options. See "How To Build a Model Number".
- Any special service required.

Note: • The indicates that a choice is required.

- The absence of the indicates that no choice is required.
- Alpha-numeric characters in place of indicate that no other alternatives are available.

HOW TO BUILD A MODEL NUMBER

- A** Select basic model.
- B** Select non-contrast or fabric contrast 1.
Refer to ki.com/fabrics.
• For yardage pricing, see Fabric Yardage Pricing page
- C** Select fabric contrast 2.
Refer to ki.com/fabrics.
• For yardage pricing, see Fabric Yardage Pricing page
- D** Select wood finish.
- | | |
|------------|------------------------|
| AEB | - Eclipse Black on Ash |
| ANA | - Natural on Ash |
| ARY | - River Cherry on Ash |
- Refer to the **Product Color Options** page in this price list.
- E** Select glide option.
- | | |
|------------|--------------------------|
| GFT | - Felt glides; add \$16 |
| GNY | - Nylon glides; add \$16 |
| GNN | - No glides |

SPECIAL SERVICES

Special Carton Marking

With specially marked information N/C

Shipping

Ships **assembled, FOB Sheboygan, WI 53081, freight prepaid.** Freight class 300.

Specifications and prices are subject to change without prior notice.



Cascha™ Lounge Seating

Lounge Chair, Armless, Wood Swivel Base, With Welting



Cascha™ Lounge Seating

Lounge Chair, Armless, Wood Swivel Base, With Welting

MODEL	MODEL NUMBER						Approx. Packaged Weight	Delivered Pricing
	Basic Model	Non-Contrast or Fabric Contrast 1	Fabric Contrast 2	Welting Color	Wood Finish	Glide Option		
 CAL4K Lounge Chair, Armless, Wood Swivel Base, Non-Contrast, With Welting <ul style="list-style-type: none"> Fully upholstered with ash wood & steel swivel base Includes 0.25" contrasting perimeter welt Fixed height Non-contrast C.O.M = 2.5 yds Overall Dimensions: W=26.5" D=28.5" H=32.25" 	CAL4KNP	<input type="checkbox"/> <input type="checkbox"/> <input type="checkbox"/> <input type="checkbox"/>		<input type="checkbox"/> <input type="checkbox"/> <input type="checkbox"/> <input type="checkbox"/>	<input type="checkbox"/> <input type="checkbox"/>	<input type="checkbox"/> <input type="checkbox"/>	38.00#	\$ 1590
 CAL4K Lounge Chair, Armless, Wood Swivel Base, Contrast, With Welting <ul style="list-style-type: none"> Fully upholstered with ash wood & steel swivel base Includes 0.25" contrasting perimeter welt Fixed height 1 = Top of Seat & Inside Back (Fabric Contrast 1) C.O.M. = 1.25 yds 2 = Bottom of Seat & Outside Back (Fabric Contrast 2) C.O.M. = 1.25 yds Overall Dimensions: W=26.5" D=28.5" H=32.25" 	CAL4KCP	<input type="checkbox"/> <input type="checkbox"/> <input type="checkbox"/> <input type="checkbox"/>	<input type="checkbox"/> <input type="checkbox"/> <input type="checkbox"/> <input type="checkbox"/>	<input type="checkbox"/> <input type="checkbox"/> <input type="checkbox"/> <input type="checkbox"/>	<input type="checkbox"/> <input type="checkbox"/>	<input type="checkbox"/> <input type="checkbox"/>	38.00#	\$ 1620
	A	B	C	D	E	F		

HOW TO ORDER

Indicate the following information on order form:

- Quantity of each item.
- Model number, including options. See "How To Build a Model Number".
- Any special service required.

Note: • The indicates that a choice is required.

- The absence of the indicates that no choice is required.
- Alpha-numeric characters in place of indicate that no other alternatives are available.

HOW TO BUILD A MODEL NUMBER

A Select basic model.

B Select non-contrast or fabric contrast 1.

- Refer to ki.com/fabrics.
- For yardage pricing, see Fabric Yardage Pricing page

C Select fabric contrast 2.

- Refer to ki.com/fabrics
- For yardage pricing, see Fabric Yardage Pricing page

D Select welting color.

- Refer to the **Product Color Options** page in this price list.

E Select wood finish.

AEB - Eclipse Black on Ash

ANA - Natural on Ash

ARY - River Cherry on Ash

- Refer to the **Product Color Options** page in this price list.

F Select glide option.

GFT - Felt glides; add \$16

GNY - Nylon glides; add \$16

GNN - No glides

SPECIAL SERVICES

Special Carton Marking

With specially marked information N/C

Shipping

Ships **assembled, FOB Sheboygan, WI 53081, freight prepaid.** Freight class 300.

Specifications and prices are subject to change without prior notice.

Cascha™ Lounge Seating

Lounge Chair, Armless, Rocking Base



Cascha™ Lounge Seating

Lounge Chair, Armless, Rocking Base

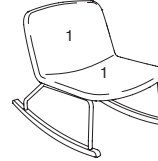
MODEL	MODEL NUMBER					Approx. Packaged Weight	Delivered Pricing
	Basic Model	Non-Contrast or Fabric Contrast 1	Fabric Contrast 2	Wood Finish	Metal Finish		
 <p>Lounge Chair, Armless, Rocking Base, Non-Contrast</p> <ul style="list-style-type: none"> Fully upholstered with steel & ash wood rocking base Fixed height Non-contrast C.O.M = 2.5 yds Overall Dimensions: W=26.5" D=35.5" H=30" 	CALRWNN	□□□□		□□□	□□	39.00#	\$ 1400
CALRW							
 <p>Lounge Chair, Armless, Rocking Base, Contrast</p> <ul style="list-style-type: none"> Fully upholstered with steel & ash wood rocking base Fixed height 1 = Top of Seat & Inside Back (Fabric Contrast 1) C.O.M. = 1.25 yds 2 = Bottom of Seat & Outside Back (Fabric Contrast 2) C.O.M. = 1.25 yds Overall Dimensions: W=26.5" D=35.5" H=30" 	CALRWCN	□□□□	□□□□	□□□	□□	39.00#	\$ 1430
CALRW							
	A	B	C	D	E		

HOW TO ORDER

Indicate the following information on order form:

- Quantity of each item.
- Model number, including options. See "How To Build a Model Number".
- Any special service required.

Note: • The indicates that a choice is required.

- The absence of the indicates that no choice is required.
- Alpha-numeric characters in place of indicate that no other alternatives are available.

HOW TO BUILD A MODEL NUMBER

A Select basic model.

B Select non-contrast or fabric contrast 1.

- Refer to ki.com/fabrics.
- For yardage pricing, see Fabric Yardage Pricing page

C Select fabric contrast 2.

- Refer to ki.com/fabrics
- For yardage pricing, see Fabric Yardage Pricing page

D Select wood finish.

- AEB** - Eclipse Black on Ash
- ANA** - Natural on Ash
- ARY** - River Cherry on Ash

Refer to the **Product Color Options** page in this price list.

E Select metal finish.

- BL** - Black
- CH** - Chrome
- CG** - Cool Grey
- CO** - Cottonwood
- WG** - Warm Grey

Refer to the **Product Color Options** page in this price list.

SPECIAL SERVICES

Special Carton Marking



With specially marked information N/C

Shipping

Ships **assembled, FOB Sheboygan, WI 53081, freight prepaid.** Freight class 300.

Specifications and prices are subject to change without prior notice.



MODEL	MODEL NUMBER						Approx. Packaged Weight	Delivered Pricing
	Basic Model	Non-Contrast or Fabric Contrast 1	Fabric Contrast 2	Welting Color	Wood Finish	Metal Finish		
 CALRW Lounge Chair, Armless, Rocking Base, Non-Contrast, With Welting • Fully upholstered with steel & ash wood rocking base • Includes 0.25" contrasting perimeter welt • Fixed height • Non-contrast C.O.M = 2.5 yds • Overall Dimensions: W=26.5" D=35.5" H=30"	CALRWNP	<input type="checkbox"/> <input type="checkbox"/> <input type="checkbox"/> <input type="checkbox"/>		<input type="checkbox"/> <input type="checkbox"/> <input type="checkbox"/> <input type="checkbox"/>	<input type="checkbox"/> <input type="checkbox"/>	<input type="checkbox"/> <input type="checkbox"/>	39.00#	\$ 1520
 CALRW Lounge Chair, Armless, Rocking Base, Contrast, With Welting • Fully upholstered with steel & ash wood rocking base • Includes 0.25" contrasting perimeter welt • Fixed height • 1 = Top of Seat & Inside Back (Fabric Contrast 1) C.O.M. = 1.25 yds • 2 = Bottom of Seat & Outside Back (Fabric Contrast 2) C.O.M. = 1.25 yds • Overall Dimensions: W=26.5" D=35.5" H=30"	CALRWCP	<input type="checkbox"/> <input type="checkbox"/> <input type="checkbox"/> <input type="checkbox"/>	<input type="checkbox"/> <input type="checkbox"/> <input type="checkbox"/> <input type="checkbox"/>	<input type="checkbox"/> <input type="checkbox"/> <input type="checkbox"/> <input type="checkbox"/>	<input type="checkbox"/> <input type="checkbox"/>	<input type="checkbox"/> <input type="checkbox"/>	39.00#	\$ 1550

A **B** **C** **D** **E** **F**

HOW TO ORDER

- Indicate the following information on order form:
- Quantity of each item.
 - Model number, including options. See "How To Build a Model Number".
 - Any special service required.

Note:

- The indicates that a choice is required.
- The absence of the indicates that no choice is required.
- Alpha-numeric characters in place of indicate that no other alternatives are available.

HOW TO BUILD A MODEL NUMBER

- A** Select basic model.
- B** Select non-contrast or fabric contrast 1. Refer to ki.com/fabrics.
 • For yardage pricing, see Fabric Yardage Pricing page
- C** Select fabric contrast 2. Refer to ki.com/fabrics.
 • For yardage pricing, see Fabric Yardage Pricing page
- D** Select welting color. Refer to the **Product Color Options** page in this price list.
- E** Select wood finish.

AEB	- Eclipse Black on Ash
ANA	- Natural on Ash
ARY	- River Cherry on Ash

 Refer to the **Product Color Options** page in this price list.

- F** Select metal finish.

BL	- Black
CH	- Chrome
CG	- Cool Grey
CO	- Cottonwood
WG	- Warm Grey

 Refer to the **Product Color Options** page in this price list.

SPECIAL SERVICES

Special Carton Marking

With specially marked information N/C

Shipping
Ships assembled, FOB Sheboygan, WI 53081, freight prepaid. Freight class 300.

Specifications and prices are subject to change without prior notice.

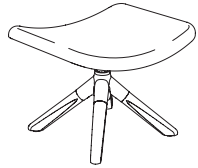
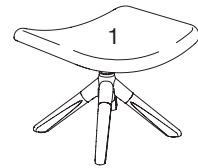

MODEL	MODEL NUMBER						Approx. Packaged Weight	Delivered Pricing
	Basic Model	Non-Contrast or Fabric Contrast 1	Fabric Contrast 2	Wood Finish	Metal Finish	Glide Option		
 <p>Ottoman, Wood Swivel Base, Non-Contrast</p> <ul style="list-style-type: none"> Fully upholstered with ash wood & aluminum swivel base Fixed height Non-contrast C.O.M = .75 yds Overall Dimensions: W=21.5" D=21.5" H=16.25" 	CAF4KNN	<input type="checkbox"/> <input type="checkbox"/> <input type="checkbox"/> <input type="checkbox"/>		<input type="checkbox"/> <input type="checkbox"/>	<input type="checkbox"/>	<input type="checkbox"/> <input type="checkbox"/>	17.00#	\$ 790
CAF4K								
 <p>Ottoman, Wood Swivel Base, Contrast</p> <ul style="list-style-type: none"> Fully upholstered with ash wood & aluminum swivel base Fixed height 1 = Top of Seat (Fabric Contrast 1) C.O.M. = 0.75 yds 2 = Bottom of Seat (Fabric Contrast 2) C.O.M. = 0.75 yds Overall Dimensions: W=21.5" D=21.5" H=16.25" 	CAF4KCN	<input type="checkbox"/> <input type="checkbox"/> <input type="checkbox"/> <input type="checkbox"/>	<input type="checkbox"/> <input type="checkbox"/> <input type="checkbox"/>	<input type="checkbox"/> <input type="checkbox"/>	<input type="checkbox"/>	<input type="checkbox"/> <input type="checkbox"/>	17.00#	\$ 810
CAF4K								
		A	B	C	D	E	F	

HOW TO ORDER

- Indicate the following information on order form:
- Quantity of each item.
 - Model number, including options. See "How To Build a Model Number".
 - Any special service required.

Note:

- The indicates that a choice is required.
- The absence of the indicates that no choice is required.
- Alpha-numeric characters in place of indicate that no other alternatives are available.

HOW TO BUILD A MODEL NUMBER

- A** Select basic model.
- B** Select non-contrast or fabric contrast 1.
Refer to ki.com/fabrics.
• For yardage pricing, see Fabric Yardage Pricing page
- C** Select fabric contrast 2.
Refer to ki.com/fabrics.
• For yardage pricing, see Fabric Yardage Pricing page
- D** Select wood finish.
AEB - Eclipse Black on Ash
ANA - Natural on Ash
ARY - River Cherry on Ash
Refer to the **Product Color Options** page in this price list.

- E** Select metal finish.
BL - Black
PA - Polished Aluminum
Refer to the **Product Color Options** page in this price list.
- F** Select glide option.
GFT - Felt glides; add \$16
GNY - Nylon glides; add \$16
GNN - No glides

SPECIAL SERVICES

Special Carton Marking

With specially marked information N/C

Shipping

Ships **assembled, FOB Sheboygan, WI 53081, freight prepaid.** Freight class 250.

Specifications and prices are subject to change without prior notice.

Cascha™ Lounge Seating

Ottoman, Metal Swivel Base



Cascha™ Lounge Seating

Ottoman, Metal Swivel Base

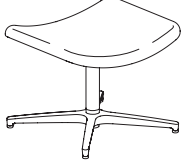
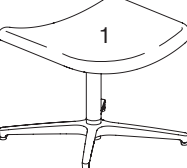
MODEL	MODEL NUMBER					Approx. Packaged Weight	Delivered Pricing
	Basic Model	Non-Contrast or Fabric Contrast 1	Fabric Contrast 2	Metal Finish	Glide Option		
 <p>Ottoman, Metal Swivel Base, Non-Contrast</p> <ul style="list-style-type: none"> Fully upholstered with aluminum swivel base Fixed height Non-contrast C.O.M = .75 yds Overall Dimensions: W=21.5" D=18.25" H=16.75" 	CAFSGNN	<input type="checkbox"/> <input type="checkbox"/> <input type="checkbox"/> <input type="checkbox"/>		<input type="checkbox"/> <input type="checkbox"/>	<input type="checkbox"/> <input type="checkbox"/>	17.00#	\$ 690
CAFSG							
 <p>Ottoman, Metal Swivel Base, Contrast</p> <ul style="list-style-type: none"> Fully upholstered with aluminum swivel base Fixed height 1 = Top of Seat (Fabric Contrast 1) C.O.M. = 0.75 yds 2 = Bottom of Seat (Fabric Contrast 2) C.O.M. = 0.75 yds Overall Dimensions: W=21.5" D=18.25" H=16.75" 	CAFSGCN	<input type="checkbox"/> <input type="checkbox"/> <input type="checkbox"/> <input type="checkbox"/>	<input type="checkbox"/> <input type="checkbox"/> <input type="checkbox"/> <input type="checkbox"/>	<input type="checkbox"/> <input type="checkbox"/>	<input type="checkbox"/> <input type="checkbox"/>	17.00#	\$ 710
CAFSG							
		A	B	C	D	E	

HOW TO ORDER

Indicate the following information on order form:

- Quantity of each item.
- Model number, including options. See "How To Build a Model Number".
- Any special service required.

Note: • The indicates that a choice is required.

- The absence of the indicates that no choice is required.
- Alpha-numeric characters in place of indicate that no other alternatives are available.

HOW TO BUILD A MODEL NUMBER

- A** Select basic model.
- B** Select non-contrast or fabric contrast 1.
Refer to ki.com/fabrics.
• For yardage pricing, see Fabric Yardage Pricing page
- C** Select fabric contrast 2.
Refer to ki.com/fabrics.
• For yardage pricing, see Fabric Yardage Pricing page
- D** Select metal finish.
BL - Black
PA - Polished Aluminum
Refer to the **Product Color Options** page in this price list.
- E** Select glide option.
GFT - Felt glides
GNV - Nylon glides

SPECIAL SERVICES

Special Carton Marking

With specially marked information N/C

Shipping

Ships **assembled, FOB Sheboygan, WI 53081, freight prepaid.** Freight class 250.

Specifications and prices are subject to change without prior notice.



Cascha™ Lounge Seating

Ottoman, Metal Swivel Base, With Welting



Cascha™ Lounge Seating

Ottoman, Metal Swivel Base, With Welting

MODEL	MODEL NUMBER						Approx. Packaged Weight	Delivered Pricing
	Basic Model	Non-Contrast or Fabric Contrast 1	Fabric Contrast 2	Welting Color	Metal Finish	Glide Option		
 <p>CAFSG</p> <p>Ottoman, Wood Swivel Base, Non-Contrast, With Welting</p> <ul style="list-style-type: none"> Fully upholstered with aluminum swivel base Includes 0.25" contrasting perimeter welt Fixed height Non-contrast C.O.M = .75 yds Overall Dimensions: W=21.5" D=18.25" H=16.75" 	CAFSGNP	<input type="checkbox"/> <input type="checkbox"/> <input type="checkbox"/> <input type="checkbox"/>		<input type="checkbox"/> <input type="checkbox"/> <input type="checkbox"/> <input type="checkbox"/>	<input type="checkbox"/> <input type="checkbox"/>	<input type="checkbox"/> <input type="checkbox"/>	17.00#	\$ 770
 <p>CAFSG</p> <p>Ottoman, Wood Swivel Base, Contrast, With Welting</p> <ul style="list-style-type: none"> Fully upholstered with aluminum swivel base Includes 0.25" contrasting perimeter welt Fixed height 1 = Top of Seat (Fabric Contrast 1) C.O.M. = 0.75 yds 2 = Bottom of Seat (Fabric Contrast 2) C.O.M. = 0.75 yds Overall Dimensions: W=21.5" D=18.25" H=16.75" 	CAFSGCP	<input type="checkbox"/> <input type="checkbox"/> <input type="checkbox"/> <input type="checkbox"/>	<input type="checkbox"/> <input type="checkbox"/> <input type="checkbox"/> <input type="checkbox"/>	<input type="checkbox"/> <input type="checkbox"/> <input type="checkbox"/> <input type="checkbox"/>	<input type="checkbox"/> <input type="checkbox"/>	<input type="checkbox"/> <input type="checkbox"/>	17.00#	\$ 790
	A	B	C	D	E	F		

HOW TO ORDER

Indicate the following information on order form:

- Quantity of each item.
- Model number, including options. See "How To Build a Model Number".
- Any special service required.

Note: • The indicates that a choice is required.

- The absence of the indicates that no choice is required.
- Alpha-numeric characters in place of indicate that no other alternatives are available.

HOW TO BUILD A MODEL NUMBER

A Select basic model.

B Select non-contrast or fabric contrast 1.
Refer to ki.com/fabrics.
• For yardage pricing, see Fabric Yardage Pricing page

C Select fabric contrast 2.
Refer to ki.com/fabrics.
• For yardage pricing, see Fabric Yardage Pricing page

D Select welting color.
Refer to the **Product Color Options** page in this price list.

E Select metal finish.
BL - Black
PA - Polished Aluminum
Refer to the **Product Color Options** page in this price list.

F Select glide option.
GFT - Felt glides
GNY - Nylon glides

SPECIAL SERVICES

Special Carton Marking

With specially marked information N/C

Shipping

Ships assembled, FOB Sheboygan, WI 53081, freight prepaid. Freight class 250.

Specifications and prices are subject to change without prior notice.



Cascha™ Guest Seating - Armless

Guest Chair, Armless, Metal Four-Leg Base



Cascha™ Guest Seating - Armless

Guest Chair, Armless, Metal Four-Leg Base

MODEL	MODEL NUMBER					Approx. Packaged Weight	Delivered Pricing
	Basic Model	Non-Contrast or Fabric Contrast 1	Fabric Contrast 2	Metal Finish	Glide Option		
 <p>Guest Chair, Armless, Metal Four-Leg Base, Non-Contrast</p> <ul style="list-style-type: none"> Fully upholstered with steel legs Fixed height Non-contrast C.O.M = 1.25 yds Overall Dimensions: W=19.5" D=23.5" H=34.5" 	CAG4MNN	<input type="checkbox"/> <input type="checkbox"/> <input type="checkbox"/> <input type="checkbox"/>		<input type="checkbox"/> <input type="checkbox"/>	<input type="checkbox"/> <input type="checkbox"/>	25.00#	\$ 710
CAG4M							
 <p>Guest Chair, Armless, Metal Four-Leg Base, Contrast</p> <ul style="list-style-type: none"> Fully upholstered with steel legs Fixed height 1 = Top of Seat & Inside Back (Fabric Contrast 1) C.O.M. = 0.75 yds 2 = Bottom of Seat & Outside Back (Fabric Contrast 2) C.O.M. = 0.75 yds Overall Dimensions: W=19.5" D=23.5" H=34.5" 	CAG4MCN	<input type="checkbox"/> <input type="checkbox"/> <input type="checkbox"/> <input type="checkbox"/>	<input type="checkbox"/> <input type="checkbox"/> <input type="checkbox"/> <input type="checkbox"/>	<input type="checkbox"/> <input type="checkbox"/>	<input type="checkbox"/> <input type="checkbox"/>	25.00#	\$ 735
CAG4M							
	A	B	C	D	E		

HOW TO ORDER

Indicate the following information on order form:

- Quantity of each item.
- Model number, including options. See "How To Build a Model Number".
- Any special service required.

Note: • The indicates that a choice is required.

- The absence of the indicates that no choice is required.
- Alpha-numeric characters in place of indicate that no other alternatives are available.

HOW TO BUILD A MODEL NUMBER

A Select basic model.

B Select non-contrast or fabric contrast 1.
Refer to ki.com/fabrics.
• For yardage pricing, see Fabric Yardage Pricing page

C Select fabric contrast 2.
Refer to ki.com/fabrics.
• For yardage pricing, see Fabric Yardage Pricing page

D Select metal finish.

BL	- Black
CH	- Chrome
CG	- Cool Grey
CO	- Cottonwood
WG	- Warm Grey

Refer to the **Product Color Options** page in this price list.

E Select glide option.

GFT	- Felt glides
GNY	- Nylon glides

SPECIAL SERVICES

Special Carton Marking

With specially marked information N/C

Shipping

Ships assembled, FOB Sheboygan, WI 53081, freight prepaid. Freight class 300.

Specifications and prices are subject to change without prior notice.



Cascha™ Guest Seating - Armless

Guest Chair, Armless, Metal Four-Leg Base, With Welting



Cascha™ Guest Seating - Armless

Guest Chair, Armless, Metal Four-Leg Base, With Welting

MODEL	MODEL NUMBER						Approx. Packaged Weight	Delivered Pricing
	Basic Model	Non-Contrast or Fabric Contrast 1	Fabric Contrast 2	Welting Color	Metal Finish	Glide Option		
 <p>Guest Chair, Armless, Metal Four-Leg Base, Non-Contrast, With Welting</p> <ul style="list-style-type: none"> Fully upholstered with steel legs Includes 0.25" contrasting perimeter welt Fixed height Non-contrast C.O.M = 1.25 yds Overall Dimensions: W=19.5" D=23.5" H=34.5" 	CAG4MNP	<input type="checkbox"/> <input type="checkbox"/> <input type="checkbox"/> <input type="checkbox"/>		<input type="checkbox"/> <input type="checkbox"/> <input type="checkbox"/> <input type="checkbox"/>	<input type="checkbox"/> <input type="checkbox"/>	<input type="checkbox"/> <input type="checkbox"/> <input type="checkbox"/>	25.00#	\$ 810
CAG4M								
 <p>Guest Chair, Armless, Metal Four-Leg Base, Contrast, With Welting</p> <ul style="list-style-type: none"> Fully upholstered with steel legs Includes 0.25" contrasting perimeter welt Fixed height 1 = Top of Seat & Inside Back (Fabric Contrast 1) C.O.M. = 0.75 yds 2 = Bottom of Seat & Outside Back (Fabric Contrast 2) C.O.M. = 0.75 yds Overall Dimensions: W=19.5" D=23.5" H=34.5" 	CAG4MCP	<input type="checkbox"/> <input type="checkbox"/> <input type="checkbox"/> <input type="checkbox"/>	<input type="checkbox"/> <input type="checkbox"/> <input type="checkbox"/> <input type="checkbox"/>	<input type="checkbox"/> <input type="checkbox"/> <input type="checkbox"/> <input type="checkbox"/>	<input type="checkbox"/> <input type="checkbox"/>	<input type="checkbox"/> <input type="checkbox"/> <input type="checkbox"/>	25.00#	\$ 835
CAG4M								
	A	B	C	D	E	F		

HOW TO ORDER

- Indicate the following information on order form:
- Quantity of each item.
 - Model number, including options. See "How To Build a Model Number".
 - Any special service required.

Note:

- The indicates that a choice is required.
- The absence of the indicates that no choice is required.
- Alpha-numeric characters in place of indicate that no other alternatives are available.

HOW TO BUILD A MODEL NUMBER

- A** Select basic model.
- B** Select non-contrast or fabric contrast 1. Refer to ki.com/fabrics.
 - For yardage pricing, see Fabric Yardage Pricing page
- C** Select fabric contrast 2. Refer to ki.com/fabrics.
 - For yardage pricing, see Fabric Yardage Pricing page
- D** Select welting color. Refer to the **Product Color Options** page in this price list.
- E** Select metal finish.
 - BL** - Black
 - CH** - Chrome
 - CG** - Cool Grey
 - CO** - Cottonwood
 - WG** - Warm Grey
 Refer to the **Product Color Options** page in this price list.

- F** Select glide option.
 - GFT** - Felt glides
 - GNY** - Nylon glides

SPECIAL SERVICES

Special Carton Marking

With specially marked information N/C

Shipping
Ships **assembled, FOB Sheboygan, WI 53081, freight prepaid.** Freight class 300.

Specifications and prices are subject to change without prior notice.

Cascha™ Guest Seating - Armless

Guest Chair, Armless, Wood Four-Leg Base



Cascha™ Guest Seating - Armless

Guest Chair, Armless, Wood Four-Leg Base

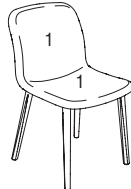
MODEL	MODEL NUMBER					Approx. Packaged Weight	Delivered Pricing
	Basic Model	Non-Contrast or Fabric Contrast 1	Fabric Contrast 2	Wood Finish	Glide Option		
 <p>Guest Chair, Armless, Wood Four-Leg Base, Non-Contrast</p> <ul style="list-style-type: none"> Fully upholstered with ash wood legs Fixed height Non-contrast C.O.M = 1.25 yds Overall Dimensions: W=19.5" D=23.5" H=34.5" 	CAG4WNN	<input type="checkbox"/> <input type="checkbox"/> <input type="checkbox"/> <input type="checkbox"/>		<input type="checkbox"/> <input type="checkbox"/> <input type="checkbox"/>	<input type="checkbox"/> <input type="checkbox"/> <input type="checkbox"/>	30.00#	\$ 940
CAG4W							
 <p>Guest Chair, Armless, Wood Four-Leg Base, Contrast</p> <ul style="list-style-type: none"> Fully upholstered with ash wood legs Fixed height 1 = Top of Seat & Inside Back (Fabric Contrast 1) C.O.M. = 0.75 yds 2 = Bottom of Seat & Outside Back (Fabric Contrast 2) C.O.M. = 0.75 yds Overall Dimensions: W=19.5" D=23.5" H=34.5" 	CAG4WCN	<input type="checkbox"/> <input type="checkbox"/> <input type="checkbox"/> <input type="checkbox"/>	<input type="checkbox"/> <input type="checkbox"/> <input type="checkbox"/> <input type="checkbox"/>	<input type="checkbox"/> <input type="checkbox"/> <input type="checkbox"/>	<input type="checkbox"/> <input type="checkbox"/> <input type="checkbox"/>	30.00#	\$ 965
CAG4W							
	A	B	C	D	E		

HOW TO ORDER

Indicate the following information on order form:

- Quantity of each item.
- Model number, including options. See "How To Build a Model Number".
- Any special service required.

Note: • The indicates that a choice is required.

- The absence of the indicates that no choice is required.
- Alpha-numeric characters in place of indicate that no other alternatives are available.

HOW TO BUILD A MODEL NUMBER

- A** Select basic model.
- B** Select non-contrast or fabric contrast 1.
Refer to ki.com/fabrics.
• For yardage pricing, see Fabric Yardage Pricing page
- C** Select fabric contrast 2.
Refer to ki.com/fabrics.
• For yardage pricing, see Fabric Yardage Pricing page
- D** Select wood finish.
- | | |
|------------|------------------------|
| AEB | - Eclipse Black on Ash |
| ANA | - Natural on Ash |
| ARY | - River Cherry on Ash |
- Refer to the **Product Color Options** page in this price list.
- E** Select glide option.
- | | |
|------------|--------------------------|
| GFT | - Felt glides; add \$16 |
| GNY | - Nylon glides; add \$16 |
| GNN | - No glides |

SPECIAL SERVICES

Special Carton Marking

With specially marked information N/C

Shipping

Ships **assembled, FOB Sheboygan, WI 53081, freight prepaid**. Freight class 250.

Specifications and prices are subject to change without prior notice.



Cascha™ Guest Seating - Armless

Guest Chair, Armless, Wood Four-Leg Base, With Welting



Cascha™ Guest Seating - Armless

Guest Chair, Armless, Wood Four-Leg Base, With Welting

MODEL	MODEL NUMBER						Approx. Packaged Weight	Delivered Pricing
	Basic Model	Non-Contrast or Fabric Contrast 1	Fabric Contrast 2	Welting Color	Wood Finish	Glide Option		
 <p>Guest Chair, Armless, Wood Four-Leg Base, Non-Contrast, With Welting</p> <ul style="list-style-type: none"> Fully upholstered with ash wood legs Includes 0.25" contrasting perimeter welt Fixed height Non-contrast C.O.M = 1.25 yds Overall Dimensions: W=19.5" D=23.5" H=34.5" 	CAG4WNP	<input type="checkbox"/>	<input type="checkbox"/>	<input type="checkbox"/>	<input type="checkbox"/>	<input type="checkbox"/>	30.00#	\$ 1040
CAG4W								
 <p>Guest Chair, Armless, Wood Four-Leg Base, Contrast, With Welting</p> <ul style="list-style-type: none"> Fully upholstered with ash wood legs Includes 0.25" contrasting perimeter welt Fixed height 1 = Top of Seat & Inside Back (Fabric Contrast 1) C.O.M. = 0.75 yds 2 = Bottom of Seat & Outside Back (Fabric Contrast 2) C.O.M. = 0.75 yds Overall Dimensions: W=19.5" D=23.5" H=34.5" 	CAG4WCP	<input type="checkbox"/>	<input type="checkbox"/>	<input type="checkbox"/>	<input type="checkbox"/>	<input type="checkbox"/>	30.00#	\$ 1065
CAG4W								
	A	B	C	D	E	F		

HOW TO ORDER

- Indicate the following information on order form:
- Quantity of each item.
 - Model number, including options. See "How to Build a Model Number".
 - Any special service required.

Note:

- The indicates that a choice is required.
- The absence of the indicates that no choice is required.
- Alpha-numeric characters in place of indicate that no other alternatives are available.

HOW TO BUILD A MODEL NUMBER

- A** Select basic model.
- B** Select non-contrast or fabric contrast 1. Refer to ki.com/fabrics.
- For yardage pricing, see Fabric Yardage Pricing page
- C** Select fabric contrast 2. Refer to ki.com/fabrics.
- For yardage pricing, see Fabric Yardage Pricing page
- D** Select welting color. Refer to the **Product Color Options** page in this price list.
- E** Select wood finish.
- AEB** - Eclipse Black on Ash
- ANA** - Natural on Ash
- ARY** - River Cherry on Ash
- Refer to the **Product Color Options** page in this price list.

F Select glide option.

- | | |
|------------|--------------------------|
| GFT | - Felt glides; add \$16 |
| GNY | - Nylon glides; add \$16 |
| GNN | - No glides |

SPECIAL SERVICES

Special Carton Marking

With specially marked information N/C

Shipping

Ships **assembled**, FOB Sheboygan, WI 53081, **freight prepaid**. Freight class 250.

Specifications and prices are subject to change without prior notice.



Cascha™ Guest Seating - Armless

Guest Chair, Armless, Height Adjustable, Metal Swivel Base With Casters



Cascha™ Guest Seating - Armless

Guest Chair, Armless, Height Adjustable, Metal Swivel Base With Casters

MODEL	MODEL NUMBER				Approx. Packaged Weight	Delivered Pricing
	Basic Model	Non-Contrast or Fabric Contrast 1	Fabric Contrast 2	Metal Finish		
 <p>Guest Chair, Armless, Height Adjustable, Metal Swivel Base With Casters, Non-Contrast</p> <ul style="list-style-type: none"> Fully upholstered with aluminum swivel base on casters Height Adjustable - nominal seat height range is 21.25 to 25.75" Non-contrast C.O.M = 1.25 yds Overall Dimensions: W=19.5" D=23.5" H=36.5 to 41" 	CAG4CNN	<input type="checkbox"/> <input type="checkbox"/> <input type="checkbox"/> <input type="checkbox"/>		<input type="checkbox"/> <input type="checkbox"/>	27.00#	\$ 890
 <p>Guest Chair, Armless, Height Adjustable, Metal Swivel Base With Casters, Contrast</p> <ul style="list-style-type: none"> Fully upholstered with aluminum swivel base on casters Height Adjustable - nominal seat height range is 21.25 to 25.75" 1 = Top of Seat & Inside Back (Fabric Contrast 1) C.O.M. = 0.75 yds 2 = Bottom of Seat & Outside Back (Fabric Contrast 2) C.O.M. = 0.75 yds Overall Dimensions: W=19.5" D=23.5" H=36.5 to 41" 	CAG4CCN	<input type="checkbox"/> <input type="checkbox"/> <input type="checkbox"/> <input type="checkbox"/>	<input type="checkbox"/> <input type="checkbox"/> <input type="checkbox"/> <input type="checkbox"/>	<input type="checkbox"/> <input type="checkbox"/>	27.00#	\$ 915
		A	B	C	D	

HOW TO ORDER

Indicate the following information on order form:

- Quantity of each item.
- Model number, including options. See "How To Build a Model Number".
- Any special service required.

Note: • The indicates that a choice is required.

- The absence of the indicates that no choice is required.
- Alpha-numeric characters in place of indicate that no other alternatives are available.

HOW TO BUILD A MODEL NUMBER

- A** Select basic model.
- B** Select non-contrast or fabric contrast 1.
Refer to ki.com/fabrics.
• For yardage pricing, see Fabric Yardage Pricing page
- C** Select fabric contrast 2.
Refer to ki.com/fabrics.
• For yardage pricing, see Fabric Yardage Pricing page
- D** Select metal finish.
BL - Black
PA - Polished Aluminum
Refer to the **Product Color Options** page in this price list.

SPECIAL SERVICES

Special Carton Marking

With specially marked information N/C

Shipping

Ships **assembled, FOB Sheboygan, WI 53081, freight prepaid.** Freight class 300.



Specifications and prices are subject to change without prior notice.

Cascha™ Guest Seating - Armless

Guest Chair, Armless, Height Adjustable, Metal Swivel Base With Casters, With Welting



Cascha™ Guest Seating - Armless
Guest Chair, Armless, Height Adjustable, Metal Swivel Base With Casters, With Welting

MODEL	MODEL NUMBER					Approx. Packaged Weight	Delivered Pricing
	Basic Model	Non-Contrast or Fabric Contrast 1	Fabric Contrast 2	Welting Color	Metal Finish		
 <p>CAG4C</p> <p>Guest Chair, Armless, Height Adjustable, Metal Swivel Base With Casters, Non-Contrast, With Welting</p> <ul style="list-style-type: none"> Fully upholstered with aluminum swivel base on casters Includes 0.25" contrasting perimeter welt Height Adjustable - nominal seat height range is 21.25 to 25.75" Non-contrast C.O.M = 1.25 yds Overall Dimensions: W=19.5" D=23.5" H=36.5 to 41" 	CAG4CNP	<input type="checkbox"/> <input type="checkbox"/> <input type="checkbox"/> <input type="checkbox"/>		<input type="checkbox"/> <input type="checkbox"/> <input type="checkbox"/> <input type="checkbox"/>	<input type="checkbox"/> <input type="checkbox"/>	27.00#	\$ 990
 <p>CAG4C</p> <p>Guest Chair, Armless, Height Adjustable, Metal Swivel Base With Casters, Contrast, With Welting</p> <ul style="list-style-type: none"> Fully upholstered with aluminum swivel base on casters Includes 0.25" contrasting perimeter welt Height Adjustable - nominal seat height range is 21.25 to 25.75" 1 = Top of Seat & Inside Back (Fabric Contrast 1) C.O.M. = 0.75 yds 2 = Bottom of Seat & Outside Back (Fabric Contrast 2) C.O.M. = 0.75 yds Overall Dimensions: W=19.5" D=23.5" H=36.5 to 41" 	CAG4CCP	<input type="checkbox"/> <input type="checkbox"/> <input type="checkbox"/> <input type="checkbox"/>	<input type="checkbox"/> <input type="checkbox"/> <input type="checkbox"/> <input type="checkbox"/>	<input type="checkbox"/> <input type="checkbox"/> <input type="checkbox"/> <input type="checkbox"/>	<input type="checkbox"/> <input type="checkbox"/>	27.00#	\$ 1015
	A	B	C	D	E		

HOW TO ORDER

Indicate the following information on order form:

- Quantity of each item.
- Model number, including options. See "How To Build a Model Number".
- Any special service required.

Note: • The indicates that a choice is required.

- The absence of the indicates that no choice is required.
- Alpha-numeric characters in place of indicate that no other alternatives are available.

HOW TO BUILD A MODEL NUMBER

- A** Select basic model.
- B** Select non-contrast or fabric contrast 1.
Refer to ki.com/fabrics.
• For yardage pricing, see Fabric Yardage Pricing page
- C** Select fabric contrast 2.
Refer to ki.com/fabrics.
• For yardage pricing, see Fabric Yardage Pricing page
- D** Select welting color.
Refer to the **Product Color Options** page in this price list.
- E** Select metal finish.
BL - Black
PA - Polished Aluminum
Refer to the **Product Color Options** page in this price list.

SPECIAL SERVICES

Special Carton Marking

With specially marked information N/C

Shipping

Ships **assembled, FOB Sheboygan, WI 53081, freight prepaid**. Freight class 300.

Specifications and prices are subject to change without prior notice.



Cascha™ Guest Seating - Armless

Guest Chair, Armless, Height Adjustable, Metal Swivel Base



Cascha™ Guest Seating - Armless

Guest Chair, Armless, Height Adjustable, Metal Swivel Base

MODEL	MODEL NUMBER					Approx. Packaged Weight	Delivered Pricing
	Basic Model	Non-Contrast or Fabric Contrast 1	Fabric Contrast 2	Metal Finish	Glide Option		
 <p>Guest Chair, Armless, Height Adjustable, Metal Swivel Base, Non-Contrast</p> <ul style="list-style-type: none"> Fully upholstered with aluminum swivel base Height Adjustable - nominal seat height range is 19.5 to 24" Non-contrast C.O.M = 1.25 yds Overall Dimensions: W=19.5" D=23.5" H=34.75 to 39.25" 	CAG4GNN	<input type="checkbox"/> <input type="checkbox"/> <input type="checkbox"/> <input type="checkbox"/>		<input type="checkbox"/> <input type="checkbox"/>	<input type="checkbox"/> <input type="checkbox"/>	28.00#	\$ 860
CAG4G							
 <p>Guest Chair, Armless, Height Adjustable, Metal Swivel Base, Contrast</p> <ul style="list-style-type: none"> Fully upholstered with aluminum swivel base Height Adjustable - nominal seat height range is 19.5 to 24" 1 = Top of Seat & Inside Back (Fabric Contrast 1) C.O.M. = 0.75 yds 2 = Bottom of Seat & Outside Back (Fabric Contrast 2) C.O.M. = 0.75 yds Overall Dimensions: W=19.5" D=23.5" H=34.75 to 39.25" 	CAG4GCN	<input type="checkbox"/> <input type="checkbox"/> <input type="checkbox"/> <input type="checkbox"/>	<input type="checkbox"/> <input type="checkbox"/> <input type="checkbox"/> <input type="checkbox"/>	<input type="checkbox"/> <input type="checkbox"/>	<input type="checkbox"/> <input type="checkbox"/>	28.00#	\$ 885
CAG4G							
	A	B	C	D	E		

HOW TO ORDER

Indicate the following information on order form:

- Quantity of each item.
- Model number, including options. See "How To Build a Model Number".
- Any special service required.

Note: • The indicates that a choice is required.

- The absence of the indicates that no choice is required.
- Alpha-numeric characters in place of indicate that no other alternatives are available.

HOW TO BUILD A MODEL NUMBER

- A** Select basic model.
- B** Select non-contrast or fabric contrast 1.
Refer to ki.com/fabrics.
• For yardage pricing, see Fabric Yardage Pricing page
- C** Select fabric contrast 2.
Refer to ki.com/fabrics.
• For yardage pricing, see Fabric Yardage Pricing page
- D** Select metal finish.
BL - Black
PA - Polished Aluminum
Refer to the **Product Color Options** page in this price list.
- E** Select glide option.
GFT - Felt glides
GNY - Nylon glides

SPECIAL SERVICES

Special Carton Marking

With specially marked information N/C

Shipping

Ships **assembled, FOB Sheboygan, WI 53081, freight prepaid**. Freight class 300.

Specifications and prices are subject to change without prior notice.



Cascha™ Guest Seating - Armless

Guest Chair, Armless, Height Adjustable, Metal Swivel Base, With Welting



Cascha™ Guest Seating - Armless

Guest Chair, Armless, Height Adjustable, Metal Swivel Base, With Welting

MODEL	MODEL NUMBER						Approx. Packaged Weight	Delivered Pricing
	Basic Model	Non-Contrast or Fabric Contrast 1	Fabric Contrast 2	Welting Color	Metal Finish	Glide Option		
 <p>CAG4G</p> <p>Guest Chair, Armless, Height Adjustable, Metal Swivel Base, Non-Contrast, With Welting</p> <ul style="list-style-type: none"> Fully upholstered with aluminum swivel base Includes 0.25" contrasting perimeter welt Height Adjustable - nominal seat height range is 19.5 to 24" Non-contrast C.O.M = 1.25 yds Overall Dimensions: W=19.5" D=23.5" H=34.75 to 39.25" 	CAG4GNP	<input type="checkbox"/> <input type="checkbox"/> <input type="checkbox"/> <input type="checkbox"/>		<input type="checkbox"/> <input type="checkbox"/> <input type="checkbox"/> <input type="checkbox"/>	<input type="checkbox"/> <input type="checkbox"/>	<input type="checkbox"/> <input type="checkbox"/>	28.00#	\$ 1008
 <p>CAG4G</p> <p>Guest Chair, Armless, Height Adjustable, Metal Swivel Base, Contrast, With Welting</p> <ul style="list-style-type: none"> Fully upholstered with aluminum swivel base Includes 0.25" contrasting perimeter welt Height Adjustable - nominal seat height range is 19.5 to 24" 1 = Top of Seat & Inside Back (Fabric Contrast 1) C.O.M. = 0.75 yds 2 = Bottom of Seat & Outside Back (Fabric Contrast 2) C.O.M. = 0.75 yds Overall Dimensions: W=19.5" D=23.5" H=34.75 to 39.25" 	CAG4GCP	<input type="checkbox"/> <input type="checkbox"/> <input type="checkbox"/> <input type="checkbox"/>	<input type="checkbox"/> <input type="checkbox"/> <input type="checkbox"/> <input type="checkbox"/>	<input type="checkbox"/> <input type="checkbox"/> <input type="checkbox"/> <input type="checkbox"/>	<input type="checkbox"/> <input type="checkbox"/>	<input type="checkbox"/> <input type="checkbox"/>	28.00#	\$ 1035
	A	B	C	D	E	F		

HOW TO ORDER

Indicate the following information on order form:

- Quantity of each item.
- Model number, including options. See "How To Build a Model Number".
- Any special service required.

Note: • The indicates that a choice is required.

- The absence of the indicates that no choice is required.
- Alpha-numeric characters in place of indicate that no other alternatives are available.

HOW TO BUILD A MODEL NUMBER

A Select basic model.

B Select non-contrast or fabric contrast 1.

Refer to ki.com/fabrics.

- For yardage pricing, see Fabric Yardage Pricing page

C Select fabric contrast 2.

Refer to ki.com/fabrics

- For yardage pricing, see Fabric Yardage Pricing page

D Select welting color.

Refer to the **Product Color Options** page in this price list.

E Select metal finish.

BL - Black

PA - Polished Aluminum

Refer to the **Product Color Options** page in this price list.

F Select glide option.

GFT - Felt glides

GNY - Nylon glides

SPECIAL SERVICES

Special Carton Marking

With specially marked information N/C

Shipping

Ships **assembled, FOB Sheboygan, WI 53081, freight prepaid.** Freight class 300.

Specifications and prices are subject to change without prior notice.



Cascha™ Guest Seating - Armless

Guest Chair, Armless, Wood Swivel Base



Cascha™ Guest Seating - Armless

Guest Chair, Armless, Wood Swivel Base

MODEL	MODEL NUMBER						Approx. Packaged Weight	Delivered Pricing
	Basic Model	Non-Contrast or Fabric Contrast 1	Fabric Contrast 2	Wood Finish	Metal Finish	Glide Option		
 <p>Guest Chair, Armless, Wood Swivel Base, Non-Contrast</p> <ul style="list-style-type: none"> Fully upholstered with ash wood & aluminum swivel base Fixed height Non-contrast C.O.M = 1.25 yds Overall Dimensions: W=19.5" D=23.5" H=33.25" 	CAG4KNN	<input type="checkbox"/> <input type="checkbox"/> <input type="checkbox"/> <input type="checkbox"/>	<input type="checkbox"/> <input type="checkbox"/> <input type="checkbox"/> <input type="checkbox"/>	<input type="checkbox"/> <input type="checkbox"/> <input type="checkbox"/> <input type="checkbox"/>	<input type="checkbox"/> <input type="checkbox"/>	<input type="checkbox"/> <input type="checkbox"/>	32.00#	\$ 1020
 <p>Guest Chair, Armless, Wood Swivel Base, Contrast</p> <ul style="list-style-type: none"> Fully upholstered with ash wood & aluminum swivel base Fixed height 1 = Top of Seat & Inside Back (Fabric Contrast 1) C.O.M. = 0.75 yds 2 = Bottom of Seat & Outside Back (Fabric Contrast 2) C.O.M. = 0.75 yds Overall Dimensions: W=19.5" D=23.5" H=33.25" 	CAG4KCN	<input type="checkbox"/> <input type="checkbox"/> <input type="checkbox"/> <input type="checkbox"/>	<input type="checkbox"/> <input type="checkbox"/> <input type="checkbox"/> <input type="checkbox"/>	<input type="checkbox"/> <input type="checkbox"/> <input type="checkbox"/> <input type="checkbox"/>	<input type="checkbox"/> <input type="checkbox"/>	<input type="checkbox"/> <input type="checkbox"/>	32.00#	\$ 1045

A **B** **C** **D** **E** **F**

HOW TO ORDER

- Indicate the following information on order form:
- Quantity of each item.
 - Model number, including options. See "How To Build a Model Number".
 - Any special service required.

Note:

- The indicates that a choice is required.
- The absence of the indicates that no choice is required.
- Alpha-numeric characters in place of indicate that no other alternatives are available.

HOW TO BUILD A MODEL NUMBER

- A** Select basic model.
- B** Select non-contrast or fabric contrast 1. Refer to ki.com/fabrics.
 - For yardage pricing, see Fabric Yardage Pricing page
- C** Select fabric contrast 2. Refer to ki.com/fabrics.
 - For yardage pricing, see Fabric Yardage Pricing page
- D** Select wood finish.
 - AEB** - Eclipse Black on Ash
 - ANA** - Natural on Ash
 - ARY** - River Cherry on Ash
 Refer to the **Product Color Options** page in this price list.

- E** Select metal finish.
 - BL** - Black
 - PA** - Polished Aluminum
 Refer to the **Product Color Options** page in this price list.
- F** Select glide option.
 - GFT** - Felt glides; add \$16
 - GNY** - Nylon glides; add \$16
 - GNN** - No glides

SPECIAL SERVICES

Special Carton Marking

With specially marked information N/C

Shipping

Ships **assembled, FOB Sheboygan, WI 53081, freight prepaid.** Freight class 250.

Specifications and prices are subject to change without prior notice.

Cascha™ Guest Seating - Armless

Guest Chair, Armless, Wood Swivel Base, With Welting



Cascha™ Guest Seating - Armless

Guest Chair, Armless, Wood Swivel Base, With Welting

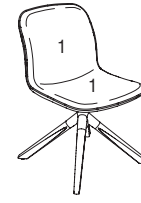
MODEL	MODEL NUMBER						Approx. Packaged Weight	Delivered Pricing
	Basic Model	Non-Contrast or Fabric Contrast 1	Fabric Contrast 2	Welting Color	Wood Finish	Glide Option		
 <p>Guest Chair, Armless, Wood Swivel Base, Non-Contrast, With Welting</p> <ul style="list-style-type: none"> Fully upholstered with ash wood & aluminum swivel base Includes 0.25" contrasting perimeter welt Fixed height Non-contrast C.O.M = 1.25 yds Overall Dimensions: W=19.5" D=23.5" H=33.25" 	CAG4KNP	<input type="checkbox"/> <input type="checkbox"/> <input type="checkbox"/> <input type="checkbox"/>		<input type="checkbox"/> <input type="checkbox"/> <input type="checkbox"/> <input type="checkbox"/>	<input type="checkbox"/> <input type="checkbox"/>	<input type="checkbox"/> <input type="checkbox"/>	32.00#	\$ 1120
 <p>Guest Chair, Armless, Wood Swivel Base, Contrast, With Welting</p> <ul style="list-style-type: none"> Fully upholstered with ash wood & aluminum swivel base Includes 0.25" contrasting perimeter welt Fixed height 1 = Top of Seat & Inside Back (Fabric Contrast 1) C.O.M. = 0.75 yds 2 = Bottom of Seat & Outside Back (Fabric Contrast 2) C.O.M. = 0.75 yds Overall Dimensions: W=19.5" D=23.5" H=33.25" 	CAG4KCP	<input type="checkbox"/> <input type="checkbox"/> <input type="checkbox"/> <input type="checkbox"/>	<input type="checkbox"/> <input type="checkbox"/> <input type="checkbox"/> <input type="checkbox"/>	<input type="checkbox"/> <input type="checkbox"/> <input type="checkbox"/> <input type="checkbox"/>	<input type="checkbox"/> <input type="checkbox"/>	<input type="checkbox"/> <input type="checkbox"/>	32.00#	\$ 1145
	A	B	C	D	E	F		

HOW TO ORDER

- Indicate the following information on order form:
- Quantity of each item.
 - Model number, including options. See "How To Build a Model Number".
 - Any special service required.

Note:

- The indicates that a choice is required.
- The absence of the indicates that no choice is required.
- Alpha-numeric characters in place of indicate that no other alternatives are available.

HOW TO BUILD A MODEL NUMBER

- A** Select basic model.
- B** Select non-contrast or fabric contrast 1. Refer to ki.com/fabrics.
- For yardage pricing, see Fabric Yardage Pricing page
- C** Select fabric contrast 2. Refer to ki.com/fabrics.
- For yardage pricing, see Fabric Yardage Pricing page
- D** Select welting color. Refer to the **Product Color Options** page in this price list.
- E** Select wood finish.
- | | |
|------------|------------------------|
| AEB | - Eclipse Black on Ash |
| ANA | - Natural on Ash |
| ARY | - River Cherry on Ash |
- Refer to the **Product Color Options** page in this price list.

F Select glide option.

- | | |
|------------|--------------------------|
| GFT | - Felt glides; add \$16 |
| GNY | - Nylon glides; add \$16 |
| GNN | - No glides |

SPECIAL SERVICES

Special Carton Marking

With specially marked information N/C

Shipping

Ships **assembled, FOB Sheboygan, WI 53081, freight prepaid.** Freight class 250.

Specifications and prices are subject to change without prior notice.

Cascha™ Guest Seating - With Arm

Guest Chair, With Arm, Metal Four-Leg Base



Cascha™ Guest Seating - With Arm

Guest Chair, With Arm, Metal Four-Leg Base

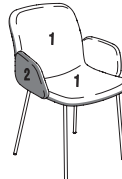
MODEL	MODEL NUMBER					Approx. Packaged Weight	Delivered Pricing
	Basic Model	Non-Contrast or Fabric Contrast 1	Fabric Contrast 2	Metal Finish	Glide Option		
 <p>Guest Chair, With Arm, Metal Four-Leg Base, Non-Contrast</p> <ul style="list-style-type: none"> Fully upholstered with steel legs Fixed height Non-contrast C.O.M = 1.5 yds Overall Dimensions: W=23.5" D=23.5" H=34.5" 	CAM4MNN	<input type="checkbox"/> <input type="checkbox"/> <input type="checkbox"/>		<input type="checkbox"/> <input type="checkbox"/>	<input type="checkbox"/> <input type="checkbox"/>	30.00#	\$ 885
 <p>Guest Chair, With Arm, Metal Four-Leg Base, Contrast</p> <ul style="list-style-type: none"> Fully upholstered with steel legs Fixed height 1 = Top of Seat & Inside Back (Fabric Contrast 1) C.O.M. = 1 yd 2 = Bottom of Seat & Outside Back (Fabric Contrast 2) C.O.M. = 1 yd Overall Dimensions: W=23.5" D=23.5" H=34.5" 	CAM4MCN	<input type="checkbox"/> <input type="checkbox"/> <input type="checkbox"/>	<input type="checkbox"/> <input type="checkbox"/> <input type="checkbox"/>	<input type="checkbox"/> <input type="checkbox"/>	<input type="checkbox"/> <input type="checkbox"/>	30.00#	\$ 915

A **B** **C** **D** **E**

HOW TO ORDER

- Indicate the following information on order form:
- Quantity of each item.
 - Model number, including options. See "How To Build a Model Number".
 - Any special service required.

Note:

- The indicates that a choice is required.
- The absence of the indicates that no choice is required.
- Alpha-numeric characters in place of indicate that no other alternatives are available.

HOW TO BUILD A MODEL NUMBER

- A** Select basic model.
- B** Select non-contrast or fabric contrast 1. Refer to ki.com/fabrics.
 - For yardage pricing, see Fabric Yardage Pricing page
- C** Select fabric contrast 2. Refer to ki.com/fabrics.
 - For yardage pricing, see Fabric Yardage Pricing page
- D** Select metal finish.
 - BL** - Black
 - CH** - Chrome
 - CG** - Cool Grey
 - CO** - Cottonwood
 - WG** - Warm Grey

- E** Select glide option.
 - GFT** - Felt glides
 - GNY** - Nylon glides

Refer to the **Product Color Options** page in this price list.

SPECIAL SERVICES

Special Carton Marking

With specially marked information N/C

Shipping

Ships **assembled, FOB Sheboygan, WI 53081, freight prepaid.** Freight class 250.

Specifications and prices are subject to change without prior notice.



Cascha™ Guest Seating - With Arm

Guest Chair, With Arm, Metal Four-Leg Base, With Welting



Cascha™ Guest Seating - With Arm

Guest Chair, With Arm, Metal Four-Leg Base, With Welting

MODEL	MODEL NUMBER						Approx. Packaged Weight	Delivered Pricing
	Basic Model	Non-Contrast or Fabric Contrast 1	Fabric Contrast 2	Welting Color	Metal Finish	Glide Option		
 <p>Guest Chair, With Arm, Metal Four-Leg Base, Non-Contrast, With Welting</p> <ul style="list-style-type: none"> Fully upholstered with steel legs Includes 0.25" contrasting perimeter welt Fixed height Non-contrast C.O.M = 1.5 yds Overall Dimensions: W=23.5" D=23.5" H=34.5" 	CAM4MNP	<input type="checkbox"/> <input type="checkbox"/> <input type="checkbox"/> <input type="checkbox"/>		<input type="checkbox"/> <input type="checkbox"/> <input type="checkbox"/> <input type="checkbox"/>	<input type="checkbox"/> <input type="checkbox"/>	<input type="checkbox"/> <input type="checkbox"/>	30.00#	\$ 1005
 <p>Guest Chair, With Arm, Metal Four-Leg Base, Contrast, With Welting</p> <ul style="list-style-type: none"> Fully upholstered with steel legs Includes 0.25" contrasting perimeter welt Fixed height 1 = Top of Seat & Inside Back (Fabric Contrast 1) C.O.M. = 1 yd 2 = Bottom of Seat & Outside Back (Fabric Contrast 2) C.O.M. = 1 yd Overall Dimensions: W=23.5" D=23.5" H=34.5" 	CAM4MCP	<input type="checkbox"/> <input type="checkbox"/> <input type="checkbox"/> <input type="checkbox"/>	<input type="checkbox"/> <input type="checkbox"/> <input type="checkbox"/> <input type="checkbox"/>	<input type="checkbox"/> <input type="checkbox"/> <input type="checkbox"/> <input type="checkbox"/>	<input type="checkbox"/> <input type="checkbox"/>	<input type="checkbox"/> <input type="checkbox"/>	30.00#	\$ 1035

A **B** **C** **D** **E** **F**

HOW TO ORDER

- Indicate the following information on order form:
- Quantity of each item.
 - Model number, including options. See "How To Build a Model Number".
 - Any special service required.

Note:

- The indicates that a choice is required.
- The absence of the indicates that no choice is required.
- Alpha-numeric characters in place of indicate that no other alternatives are available.

HOW TO BUILD A MODEL NUMBER

- A** Select basic model.
- B** Select non-contrast or fabric contrast 1. Refer to ki.com/fabrics.
 - For yardage pricing, see Fabric Yardage Pricing page
- C** Select fabric contrast 2. Refer to ki.com/fabrics.
 - For yardage pricing, see Fabric Yardage Pricing page
- D** Select welting color. Refer to the **Product Color Options** page in this price list.
- E** Select metal finish.
 - BL** - Black
 - CH** - Chrome
 - CG** - Cool Grey
 - CO** - Cottonwood
 - WG** - Warm Grey
 Refer to the **Product Color Options** page in this price list.

- F** Select glide option.
 - GFT** - Felt glides
 - GNY** - Nylon glides

SPECIAL SERVICES

Special Carton Marking

With specially marked information N/C

Shipping

Ships **assembled, FOB Sheboygan, WI 53081, freight prepaid.** Freight class 250.

Specifications and prices are subject to change without prior notice.



Cascha™ Guest Seating - With Arm

Guest Chair, With Arm, Wood Four-Leg Base



Cascha™ Guest Seating - With Arm

Guest Chair, With Arm, Wood Four-Leg Base

MODEL	MODEL NUMBER					Approx. Packaged Weight	Delivered Pricing
	Basic Model	Non-Contrast or Fabric Contrast 1	Fabric Contrast 2	Wood Finish	Glide Option		
 <p>Guest Chair, With Arm, Wood Four-Leg Base, Non-Contrast</p> <ul style="list-style-type: none"> Fully upholstered with ash wood legs Fixed height Non-contrast C.O.M = 1.5 yds Overall Dimensions: W=23.5" D=23.5" H=34.5" 	CAM4WNN	<input type="checkbox"/> <input type="checkbox"/> <input type="checkbox"/> <input type="checkbox"/>		<input type="checkbox"/> <input type="checkbox"/>	<input type="checkbox"/> <input type="checkbox"/>	35.00#	\$ 1115
CAM4W							
 <p>Guest Chair, With Arm, Wood Four-Leg Base, Contrast</p> <ul style="list-style-type: none"> Fully upholstered with ash wood legs Fixed height 1 = Top of Seat & Inside Back (Fabric Contrast 1) C.O.M. = 1 yd 2 = Bottom of Seat & Outside Back (Fabric Contrast 2) C.O.M. = 1 yd Overall Dimensions: W=23.5" D=23.5" H=34.5" 	CAM4WCN	<input type="checkbox"/> <input type="checkbox"/> <input type="checkbox"/> <input type="checkbox"/>	<input type="checkbox"/> <input type="checkbox"/> <input type="checkbox"/> <input type="checkbox"/>	<input type="checkbox"/> <input type="checkbox"/>	<input type="checkbox"/> <input type="checkbox"/>	35.00#	\$ 1145
CAM4W							
	A	B	C	D	E		

HOW TO ORDER

Indicate the following information on order form:

- Quantity of each item.
- Model number, including options. See "How To Build a Model Number".
- Any special service required.

Note: • The indicates that a choice is required.

- The absence of the indicates that no choice is required.
- Alpha-numeric characters in place of indicate that no other alternatives are available.

HOW TO BUILD A MODEL NUMBER

- A** Select basic model.
- B** Select non-contrast or fabric contrast 1.
Refer to ki.com/fabrics.
• For yardage pricing, see Fabric Yardage Pricing page
- C** Select fabric contrast 2.
Refer to ki.com/fabrics.
• For yardage pricing, see Fabric Yardage Pricing page
- D** Select wood finish.
AEB - Eclipse Black on Ash
ANA - Natural on Ash
ARY - River Cherry on Ash
Refer to the **Product Color Options** page in this price list.
- E** Select glide option.
GFT - Felt glides; add \$16
GNY - Nylon glides; add \$16
GNN - No glides

SPECIAL SERVICES

Special Carton Marking

With specially marked information N/C

Shipping

Ships assembled, FOB Sheboygan, WI 53081, freight prepaid. Freight class 250.

Specifications and prices are subject to change without prior notice.

Cascha™ Guest Seating - With Arm

Guest Chair, With Arm, Wood Four-Leg Base, with Welting



Cascha™ Guest Seating - With Arm

Guest Chair, With Arm, Wood Four-Leg Base, with Welting

MODEL	MODEL NUMBER						Approx. Packaged Weight	Delivered Pricing
	Basic Model	Non-Contrast or Fabric Contrast 1	Fabric Contrast 2	Welting Color	Wood Finish	Glide Option		
 <p>Guest Chair, With Arm, Wood Four-Leg Base, Non-Contrast, With Welting</p> <ul style="list-style-type: none"> Fully upholstered with ash wood legs Includes 0.25" contrasting perimeter welt Fixed height Non-contrast C.O.M = 1.5 yds Overall Dimensions: W=23.5" D=23.5" H=34.5" 	CAM4WNP	<input type="checkbox"/> <input type="checkbox"/> <input type="checkbox"/> <input type="checkbox"/>		<input type="checkbox"/> <input type="checkbox"/> <input type="checkbox"/> <input type="checkbox"/>	<input type="checkbox"/> <input type="checkbox"/>	<input type="checkbox"/> <input type="checkbox"/>	35.00#	\$ 1235
	CAM4W							
<p>Guest Chair, With Arm, Wood Four-Leg Base, Contrast, With Welting</p> <ul style="list-style-type: none"> Fully upholstered with ash wood legs Includes 0.25" contrasting perimeter welt Fixed height 1 = Top of Seat & Inside Back (Fabric Contrast 1) C.O.M. = 1 yd 2 = Bottom of Seat & Outside Back (Fabric Contrast 2) C.O.M. = 1 yd Overall Dimensions: W=23.5" D=23.5" H=34.5" 	CAM4WCP	<input type="checkbox"/> <input type="checkbox"/> <input type="checkbox"/> <input type="checkbox"/>	<input type="checkbox"/> <input type="checkbox"/> <input type="checkbox"/> <input type="checkbox"/>	<input type="checkbox"/> <input type="checkbox"/> <input type="checkbox"/> <input type="checkbox"/>	<input type="checkbox"/> <input type="checkbox"/>	<input type="checkbox"/> <input type="checkbox"/>	35.00#	\$ 1265
	CAM4W							

A **B** **C** **D** **E** **F**

HOW TO ORDER

- Indicate the following information on order form:
- Quantity of each item.
 - Model number, including options. See "How to Build a Model Number".
 - Any special service required.

Note:

- The indicates that a choice is required.
- The absence of the indicates that no choice is required.
- Alpha-numeric characters in place of indicate that no other alternatives are available.

HOW TO BUILD A MODEL NUMBER

- A** Select basic model.
- B** Select non-contrast or fabric contrast 1. Refer to ki.com/fabrics.
 - For yardage pricing, see Fabric Yardage Pricing page
- C** Select fabric contrast 2. Refer to ki.com/fabrics.
 - For yardage pricing, see Fabric Yardage Pricing page
- D** Select welting color. Refer to the **Product Color Options** page in this price list.
- E** Select wood finish.
 - AEB** - Eclipse Black on Ash
 - ANA** - Natural on Ash
 - ARY** - River Cherry on Ash
 Refer to the **Product Color Options** page in this price list.

- F** Select glide option.

GFT	- Felt glides; add \$16
GNY	- Nylon glides; add \$16
GNN	- No glides

SPECIAL SERVICES

Special Carton Marking

With specially marked information N/C

Shipping
Ships **assembled**, FOB Sheboygan, WI 53081, **freight prepaid**. Freight class 250.

Specifications and prices are subject to change without prior notice.



Cascha™ Guest Seating - With Arm

Guest Chair, With Arm, Height Adjustable, Metal Swivel Base With Casters



Cascha™ Guest Seating - With Arm

Guest Chair, With Arm, Height Adjustable, Metal Swivel Base With Casters

MODEL	MODEL NUMBER				Approx. Packaged Weight	Delivered Pricing
	Basic Model	Non-Contrast or Fabric Contrast 1	Fabric Contrast 2	Metal Finish		
 <p>CAM4C</p> <p>Guest Chair, With Arm, Height Adjustable, Metal Swivel Base With Casters, Non-Contrast</p> <ul style="list-style-type: none"> Fully upholstered with aluminum swivel base on casters Height Adjustable - nominal seat height range is 21.25 to 25.75" Non-contrast C.O.M = 1.5 yds Overall Dimensions: W=23.5" D=23.5" H=36.5 - 41" 	CAM4CNN	<input type="checkbox"/> <input type="checkbox"/> <input type="checkbox"/> <input type="checkbox"/>		<input type="checkbox"/> <input type="checkbox"/>	32.00#	\$ 1065
 <p>CAM4C</p> <p>Guest Chair, With Arm, Height Adjustable, Metal Swivel Base With Casters, Contrast</p> <ul style="list-style-type: none"> Fully upholstered with aluminum swivel base on casters Height Adjustable - nominal seat height range is 21.25 to 25.75" 1 = Top of Seat & Inside Back (Fabric Contrast 1) C.O.M. = 1 yd 2 = Bottom of Seat & Outside Back (Fabric Contrast 2) C.O.M. = 1 yd Overall Dimensions: W=23.5" D=23.5" H=36.5 - 41" 	CAM4CCN	<input type="checkbox"/> <input type="checkbox"/> <input type="checkbox"/> <input type="checkbox"/>	<input type="checkbox"/> <input type="checkbox"/> <input type="checkbox"/> <input type="checkbox"/>	<input type="checkbox"/> <input type="checkbox"/>	32.00#	\$ 1095
		A	B	C	D	

HOW TO ORDER

Indicate the following information on order form:

- Quantity of each item.
- Model number, including options. See "How To Build a Model Number".
- Any special service required.

Note: • The indicates that a choice is required.

- The absence of the indicates that no choice is required.
- Alpha-numeric characters in place of indicate that no other alternatives are available.

HOW TO BUILD A MODEL NUMBER

- A** Select basic model.
- B** Select non-contrast or fabric contrast 1.
Refer to ki.com/fabrics.
• For yardage pricing, see Fabric Yardage Pricing page
- C** Select fabric contrast 2.
Refer to ki.com/fabrics.
• For yardage pricing, see Fabric Yardage Pricing page
- D** Select metal finish.
BL - Black
PA - Polished Aluminum
Refer to the **Product Color Options** page in this price list.

SPECIAL SERVICES

Special Carton Marking

With specially marked information N/C

Shipping

Ships **assembled, FOB Sheboygan, WI 53081, freight prepaid.** Freight class 250.



Specifications and prices are subject to change without prior notice.

Cascha™ Guest Seating - With Arm

Guest Chair, With Arm, Height Adjustable, Metal Swivel Base With Casters, With Welting



Cascha™ Guest Seating - With Arm
Guest Chair, With Arm, Height Adjustable, Metal Swivel Base With Casters, With Welting

MODEL	MODEL NUMBER					Approx. Packaged Weight	Delivered Pricing
	Basic Model	Non-Contrast or Fabric Contrast 1	Fabric Contrast 2	Welting Color	Metal Finish		
 CAM4C Guest Chair, With Arm, Height Adjustable, Metal Swivel Base With Casters, Non-Contrast, With Welting <ul style="list-style-type: none"> Fully upholstered with aluminum swivel base on casters Includes 0.25" contrasting perimeter welt Height Adjustable - nominal seat height range is 21.25 to 25.75" Non-contrast C.O.M = 1.5 yds Overall Dimensions: W=23.5" D=23.5" H=36.5 to 41" 	CAM4CNP	<input type="checkbox"/> <input type="checkbox"/> <input type="checkbox"/> <input type="checkbox"/>		<input type="checkbox"/> <input type="checkbox"/> <input type="checkbox"/> <input type="checkbox"/>	<input type="checkbox"/> <input type="checkbox"/>	32.00#	\$ 1185
 CAM4C Guest Chair, With Arm, Height Adjustable, Metal Swivel Base With Casters, Contrast, With Welting <ul style="list-style-type: none"> Fully upholstered with aluminum swivel base on casters Includes 0.25" contrasting perimeter welt Height Adjustable - nominal seat height range is 21.25 to 25.75" 1 = Top of Seat & Inside Back (Fabric Contrast 1) C.O.M. = 1 yd 2 = Bottom of Seat & Outside Back (Fabric Contrast 2) C.O.M. = 1 yd Overall Dimensions: W=23.5" D=23.5" H=36.5 to 41" 	CAM4CCP	<input type="checkbox"/> <input type="checkbox"/> <input type="checkbox"/> <input type="checkbox"/>	<input type="checkbox"/> <input type="checkbox"/> <input type="checkbox"/> <input type="checkbox"/>	<input type="checkbox"/> <input type="checkbox"/> <input type="checkbox"/> <input type="checkbox"/>	<input type="checkbox"/> <input type="checkbox"/>	32.00#	\$ 1215
	A	B	C	D	E		

HOW TO ORDER

Indicate the following information on order form:

- Quantity of each item.
- Model number, including options. See "How To Build a Model Number".
- Any special service required.

Note: • The indicates that a choice is required.

- The absence of the indicates that no choice is required.
- Alpha-numeric characters in place of indicate that no other alternatives are available.

HOW TO BUILD A MODEL NUMBER

- A** Select basic model.
- B** Select non-contrast or fabric contrast 1.
Refer to ki.com/fabrics.
• For yardage pricing, see Fabric Yardage Pricing page
- C** Select fabric contrast 2.
Refer to ki.com/fabrics.
• For yardage pricing, see Fabric Yardage Pricing page
- D** Select welting color.
Refer to the **Product Color Options** page in this price list.
- E** Select metal finish.
BL - Black
PA - Polished Aluminum
Refer to the **Product Color Options** page in this price list.

SPECIAL SERVICES

Special Carton Marking

With specially marked information N/C

Shipping

Ships **assembled, FOB Sheboygan, WI 53081, freight prepaid.** Freight class 250.

Specifications and prices are subject to change without prior notice.



Cascha™ Guest Seating - With Arm

Guest Chair, With Arm, Height Adjustable, Metal Swivel Base



Cascha™ Guest Seating - With Arm

Guest Chair, With Arm, Height Adjustable, Metal Swivel Base

MODEL	MODEL NUMBER					Approx. Packaged Weight	Delivered Pricing
	Basic Model	Non-Contrast or Fabric Contrast 1	Fabric Contrast 2	Metal Finish	Glide Option		
 <p>Guest Chair, With Arm, Height Adjustable, Metal Swivel Base, Non-Contrast</p> <ul style="list-style-type: none"> Fully upholstered with aluminum swivel base Height Adjustable - nominal seat height range is 19.5 to 24" Non-contrast C.O.M = 1.5 yds Overall Dimensions: W=23.5" D=23.5" H=34.75 to 39.25" 	CAM4GNN	<input type="checkbox"/> <input type="checkbox"/> <input type="checkbox"/> <input type="checkbox"/>		<input type="checkbox"/> <input type="checkbox"/>	<input type="checkbox"/> <input type="checkbox"/>	33.00#	\$ 1035
CAM4G							
 <p>Guest Chair, With Arm, Height Adjustable, Metal Swivel Base, Contrast</p> <ul style="list-style-type: none"> Fully upholstered with aluminum swivel base Height Adjustable - nominal seat height range is 19.5 to 24" 1 = Top of Seat & Inside Back (Fabric Contrast 1) C.O.M. = 1 yds 2 = Bottom of Seat & Outside Back (Fabric Contrast 2) C.O.M. = 1 yd Overall Dimensions: W=23.5" D=23.5" H=34.75 to 39.25" 	CAM4GCN	<input type="checkbox"/> <input type="checkbox"/> <input type="checkbox"/> <input type="checkbox"/>	<input type="checkbox"/> <input type="checkbox"/> <input type="checkbox"/> <input type="checkbox"/>	<input type="checkbox"/> <input type="checkbox"/>	<input type="checkbox"/> <input type="checkbox"/>	33.00#	\$ 1065
CAM4G							
	A	B	C	D	E		

HOW TO ORDER

Indicate the following information on order form:

- Quantity of each item.
- Model number, including options. See "How To Build a Model Number".
- Any special service required.

Note: • The indicates that a choice is required.

- The absence of the indicates that no choice is required.
- Alpha-numeric characters in place of indicate that no other alternatives are available.

HOW TO BUILD A MODEL NUMBER

- A** Select basic model.
- B** Select non-contrast or fabric contrast 1.
Refer to ki.com/fabrics.
• For yardage pricing, see Fabric Yardage Pricing page
- C** Select fabric contrast 2.
Refer to ki.com/fabrics.
• For yardage pricing, see Fabric Yardage Pricing page
- D** Select metal finish.
BL - Black
PA - Polished Aluminum
Refer to the **Product Color Options** page in this price list.
- E** Select glide option.
GFT - Felt glides
GNY - Nylon glides

SPECIAL SERVICES

Special Carton Marking

With specially marked information N/C

Shipping

Ships assembled, FOB Sheboygan, WI 53081, freight prepaid. Freight class 250.

Specifications and prices are subject to change without prior notice.



Cascha™ Guest Seating - With Arm

Guest Chair, With Arm, Height Adjustable, Metal Swivel Base, With Welting



Cascha™ Guest Seating - With Arm

Guest Chair, With Arm, Height Adjustable, Metal Swivel Base, With Welting

MODEL	MODEL NUMBER						Approx. Packaged Weight	Delivered Pricing
	Basic Model	Non-Contrast or Fabric Contrast 1	Fabric Contrast 2	Welting Color	Metal Finish	Glide Option		
 <p>CAM4GNP</p> <p>Guest Chair, With Arm, Height Adjustable, Metal Swivel Base, Non-Contrast, With Welting</p> <ul style="list-style-type: none"> Fully upholstered with aluminum swivel base Includes 0.25" contrasting perimeter welt Height Adjustable - nominal seat height range is 19.5 to 24" Non-contrast C.O.M = 1.5 yds Overall Dimensions: W=23.5" D=23.5" H=34.75 to 39.25" 	CAM4GNP	<input type="checkbox"/> <input type="checkbox"/> <input type="checkbox"/> <input type="checkbox"/>		<input type="checkbox"/> <input type="checkbox"/> <input type="checkbox"/> <input type="checkbox"/>	<input type="checkbox"/> <input type="checkbox"/>	<input type="checkbox"/> <input type="checkbox"/>	33.00#	\$ 1155
 <p>CAM4GCP</p> <p>Guest Chair, With Arm, Height Adjustable, Metal Swivel Base, Contrast, With Welting</p> <ul style="list-style-type: none"> Fully upholstered with aluminum swivel base Includes 0.25" contrasting perimeter welt Height Adjustable - nominal seat height range is 19.5 to 24" 1 = Top of Seat & Inside Back (Fabric Contrast 1) C.O.M. = 1 yd 2 = Bottom of Seat & Outside Back (Fabric Contrast 2) C.O.M. = 1 yd Overall Dimensions: W=23.5" D=23.5" H=34.75 to 39.25" 	CAM4GCP	<input type="checkbox"/> <input type="checkbox"/> <input type="checkbox"/> <input type="checkbox"/>	<input type="checkbox"/> <input type="checkbox"/> <input type="checkbox"/> <input type="checkbox"/>	<input type="checkbox"/> <input type="checkbox"/> <input type="checkbox"/> <input type="checkbox"/>	<input type="checkbox"/> <input type="checkbox"/>	<input type="checkbox"/> <input type="checkbox"/>	33.00#	\$ 1185
	A	B	C	D	E	F		

HOW TO ORDER

- Indicate the following information on order form:
- Quantity of each item.
 - Model number, including options. See "How To Build a Model Number".
 - Any special service required.

Note:

- The indicates that a choice is required.
- The absence of the indicates that no choice is required.
- Alpha-numeric characters in place of indicate that no other alternatives are available.

HOW TO BUILD A MODEL NUMBER

- A** Select basic model.
- B** Select non-contrast or fabric contrast 1.
Refer to ki.com/fabrics.
• For yardage pricing, see Fabric Yardage Pricing page
- C** Select fabric contrast 2.
Refer to ki.com/fabrics.
• For yardage pricing, see Fabric Yardage Pricing page
- D** Select welting color.
Refer to the **Product Color Options** page in this price list.
- E** Select metal finish.
BL - Black
PA - Polished Aluminum
Refer to the **Product Color Options** page in this price list.

- F** Select glide option.
GFT - Felt glides
GNY - Nylon glides

SPECIAL SERVICES

Special Carton Marking

With specially marked information N/C

Shipping

Ships **assembled, FOB Sheboygan, WI 53081, freight prepaid.** Freight class 250.

Specifications and prices are subject to change without prior notice.



Cascha™ Guest Seating - With Arm

Guest Chair, With Arm, Wood Swivel Base



Cascha™ Guest Seating - With Arm

Guest Chair, With Arm, Wood Swivel Base

MODEL	MODEL NUMBER						Approx. Packaged Weight	Delivered Pricing
	Basic Model	Non-Contrast or Fabric Contrast 1	Fabric Contrast 2	Wood Finish	Metal Finish	Glide Option		
 <p>Guest Chair, With Arm, Wood Swivel Base, Non-Contrast</p> <ul style="list-style-type: none"> Fully upholstered with ash wood & aluminum swivel base Fixed height Non-contrast C.O.M = 1.5 yds Overall Dimensions: W=23.5" D=23.5" H=33.25" 	CAM4KNN	<input type="checkbox"/> <input type="checkbox"/> <input type="checkbox"/> <input type="checkbox"/>		<input type="checkbox"/> <input type="checkbox"/> <input type="checkbox"/>	<input type="checkbox"/> <input type="checkbox"/>	<input type="checkbox"/> <input type="checkbox"/> <input type="checkbox"/>	37.00#	\$ 1195
CAM4K								
 <p>Guest Chair, With Arm, Wood Swivel Base, Contrast</p> <ul style="list-style-type: none"> Fully upholstered with ash wood & aluminum swivel base Fixed height 1 = Top of Seat & Inside Back (Fabric Contrast 1) C.O.M. = 1 yd 2 = Bottom of Seat & Outside Back (Fabric Contrast 2) C.O.M. = 1 yd Overall Dimensions: W=23.5" D=23.5" H=33.25" 	CAM4KCN	<input type="checkbox"/> <input type="checkbox"/> <input type="checkbox"/> <input type="checkbox"/>	<input type="checkbox"/> <input type="checkbox"/> <input type="checkbox"/> <input type="checkbox"/>	<input type="checkbox"/> <input type="checkbox"/> <input type="checkbox"/>	<input type="checkbox"/> <input type="checkbox"/>	<input type="checkbox"/> <input type="checkbox"/> <input type="checkbox"/>	37.00#	\$ 1225
CAM4K								
		A	B	C	D	E	F	

HOW TO ORDER

Indicate the following information on order form:

- Quantity of each item.
- Model number, including options. See "How To Build a Model Number".
- Any special service required.

Note: • The indicates that a choice is required.

- The absence of the indicates that no choice is required.
- Alpha-numeric characters in place of indicate that no other alternatives are available.

HOW TO BUILD A MODEL NUMBER

A Select basic model.**B** Select non-contrast or fabric contrast 1.Refer to ki.com/fabrics.

- For yardage pricing, see Fabric Yardage Pricing page

C Select fabric contrast 2.Refer to ki.com/fabrics

- For yardage pricing, see Fabric Yardage Pricing page

D Select wood finish.**AEB** - Eclipse Black on Ash**ANA** - Natural on Ash**ARY** - River Cherry on AshRefer to the **Product Color Options** page in this price list.**E** Select metal finish.**BL** - Black**PA** - Polished AluminumRefer to the **Product Color Options** page in this price list.**F** Select glide option.**GFT** - Felt glides; add \$16**GNY** - Nylon glides; add \$16**GNN** - No glides

SPECIAL SERVICES

Special Carton Marking

With specially marked information N/C

Shipping

Ships **assembled, FOB Sheboygan, WI 53081, freight prepaid.** Freight class 250.

Specifications and prices are subject to change without prior notice.



Cascha™ Guest Seating - With Arm

Guest Chair, With Arm, Wood Swivel Base, With Welting



Cascha™ Guest Seating - With Arm

Guest Chair, With Arm, Wood Swivel Base, With Welting

MODEL	MODEL NUMBER							Approx. Packaged Weight	Delivered Pricing
	Basic Model	Non-Contrast or Fabric Contrast 1	Fabric Contrast 2	Welting Color	Wood Finish	Metal Finish	Glide Option		
 <p>Guest Chair, With Arm, Wood Swivel Base, Non-Contrast, With Welting</p> <ul style="list-style-type: none"> Fully upholstered with ash wood & aluminum swivel base Includes 0.25" contrasting perimeter welt Fixed height Non-contrast C.O.M = 1.5 yds Overall Dimensions: W=23.5" D=23.5" H=33.25" 	CAM4KNP	<input type="checkbox"/> <input type="checkbox"/> <input type="checkbox"/> <input type="checkbox"/>		<input type="checkbox"/> <input type="checkbox"/> <input type="checkbox"/> <input type="checkbox"/>	<input type="checkbox"/> <input type="checkbox"/>	<input type="checkbox"/> <input type="checkbox"/>	<input type="checkbox"/> <input type="checkbox"/>	37.00#	\$ 1315
CAM4K									
 <p>Guest Chair, With Arm, Wood Swivel Base, Contrast, With Welting</p> <ul style="list-style-type: none"> Fully upholstered with ash wood & aluminum swivel base Includes 0.25" contrasting perimeter welt Fixed height 1 = Top of Seat & Inside Back (Fabric Contrast 1) C.O.M. = 1 yd 2 = Bottom of Seat & Outside Back (Fabric Contrast 2) C.O.M. = 1 yd Overall Dimensions: W=23.5" D=23.5" H=33.25" 	CAM4KCP	<input type="checkbox"/> <input type="checkbox"/> <input type="checkbox"/> <input type="checkbox"/>	<input type="checkbox"/> <input type="checkbox"/> <input type="checkbox"/> <input type="checkbox"/>	<input type="checkbox"/> <input type="checkbox"/> <input type="checkbox"/> <input type="checkbox"/>	<input type="checkbox"/> <input type="checkbox"/>	<input type="checkbox"/> <input type="checkbox"/>	<input type="checkbox"/> <input type="checkbox"/>	37.00#	\$ 1345
CAM4K									
	A	B	C	D	E	F	G		

HOW TO ORDER

Indicate the following information on order form:

- Quantity of each item.
- Model number, including options. See "How To Build a Model Number".
- Any special service required.

Note: • The indicates that a choice is required.

- The absence of the indicates that no choice is required.
- Alpha-numeric characters in place of indicate that no other alternatives are available.

HOW TO BUILD A MODEL NUMBER

A Select basic model.**B** Select non-contrast or fabric contrast 1.Refer to ki.com/fabrics.

- For yardage pricing, see Fabric Yardage Pricing page

C Select fabric contrast 2.Refer to ki.com/fabrics

- For yardage pricing, see Fabric Yardage Pricing page

D Select welting color.Refer to the **Product Color Options** page in this price list.**E** Select wood finish.**AEB** - Eclipse Black on Ash**ANA** - Natural on Ash**ARY** - River Cherry on AshRefer to the **Product Color Options** page in this price list.**F** Select metal finish.**BL** - Black**PA** - Polished AluminumRefer to the **Product Color Options** page in this price list.**G** Select glide option.**GFT** - Felt glides; add \$16**GNV** - Nylon glides; add \$16**GNN** - No glides

SPECIAL SERVICES

Special Carton Marking

With specially marked information N/C

Shipping

Ships **assembled, FOB Sheboygan, WI 53081, freight prepaid**. Freight class 250.

Specifications and prices are subject to change without prior notice.



Cascha™ Stools - Armless

Stool, Armless, Metal Four-Leg Base, 24" High



Cascha™ Stools - Armless

Stool, Armless, Metal Four-Leg Base, 24" High

MODEL	MODEL NUMBER					Approx. Packaged Weight	Delivered Pricing
	Basic Model	Non-Contrast or Fabric Contrast 1	Fabric Contrast 2	Metal Finish	Glide Option		
 <p>Stool, Armless, Metal Four-Leg Base, 24" High, Non-Contrast</p> <ul style="list-style-type: none"> Fully upholstered with steel legs Fixed counter height Non-contrast C.O.M = 1 yd Overall Dimensions: W=19.5" D=21.25" H=37" 	CAS4MNN24	<input type="checkbox"/> <input type="checkbox"/> <input type="checkbox"/> <input type="checkbox"/>		<input type="checkbox"/> <input type="checkbox"/>	<input type="checkbox"/> <input type="checkbox"/>	25.00#	\$ 745
CAS4M							
 <p>Stool, Armless, Metal Four-Leg Base, 24" High, Contrast</p> <ul style="list-style-type: none"> Fully upholstered with steel legs Fixed counter height 1 = Top of Seat & Inside Back (Fabric Contrast 1) C.O.M. = 0.5 yds 2 = Bottom of Seat & Outside Back (Fabric Contrast 2) C.O.M. = 0.75 yds Overall Dimensions: W=19.5" D=21.25" H=37" 	CAS4MCN24	<input type="checkbox"/> <input type="checkbox"/> <input type="checkbox"/> <input type="checkbox"/>	<input type="checkbox"/> <input type="checkbox"/> <input type="checkbox"/> <input type="checkbox"/>	<input type="checkbox"/> <input type="checkbox"/>	<input type="checkbox"/> <input type="checkbox"/>	25.00#	\$ 770
CAS4M							
	A	B	C	D	E		

HOW TO ORDER

Indicate the following information on order form:

- Quantity of each item.
- Model number, including options. See "How To Build a Model Number".
- Any special service required.

Note: • The indicates that a choice is required.

- The absence of the indicates that no choice is required.
- Alpha-numeric characters in place of indicate that no other alternatives are available.

HOW TO BUILD A MODEL NUMBER

GNV - Nylon glides

- A** Select basic model.
- B** Select non-contrast or fabric contrast 1.
Refer to ki.com/fabrics.
• For yardage pricing, see Fabric Yardage Pricing page
- C** Select fabric contrast 2.
Refer to ki.com/fabrics.
• For yardage pricing, see Fabric Yardage Pricing page
- D** Select metal finish.
- BL** - Black
- CH** - Chrome
- CG** - Cool Grey
- CO** - Cottonwood
- WG** - Warm Grey
- Refer to the **Product Color Options** page in this price list.
- E** Select glide option.
- GFT** - Felt glides

SPECIAL SERVICES

Special Carton Marking

With specially marked information N/C

Shipping

Ships **assembled, FOB Sheboygan, WI 53081, freight prepaid.** Freight class 250.

Specifications and prices are subject to change without prior notice.



Cascha™ Stools - Armless

Stool, Armless, Metal Four-Leg Base, 24" High, With Welting



Cascha™ Stools - Armless

Stool, Armless, Metal Four-Leg Base, 24" High, With Welting

MODEL	MODEL NUMBER						Approx. Packaged Weight	Delivered Pricing
	Basic Model	Non-Contrast or Fabric Contrast 1	Fabric Contrast 2	Welting Color	Metal Finish	Glide Option		
 <p>Stool, Armless, Metal Four-Leg Base, 24" High, Non-Contrast, With Welting</p> <ul style="list-style-type: none"> Fully upholstered with steel legs Includes 0.25" contrasting perimeter welt Fixed counter height Non-contrast C.O.M = 1 yd Overall Dimensions: W=19.5" D=21.25" H=37" 	CAS4MNP24	<input type="checkbox"/> <input type="checkbox"/> <input type="checkbox"/> <input type="checkbox"/>		<input type="checkbox"/> <input type="checkbox"/> <input type="checkbox"/> <input type="checkbox"/>	<input type="checkbox"/> <input type="checkbox"/>	<input type="checkbox"/> <input type="checkbox"/>	25.00#	\$ 845
CAS4M								
 <p>Stool, Armless, Metal Four-Leg Base, 24" High, Contrast, With Welting</p> <ul style="list-style-type: none"> Fully upholstered with steel legs Includes 0.25" contrasting perimeter welt Fixed counter height 1 = Top of Seat & Inside Back (Fabric Contrast 1) C.O.M. = 0.5 yds 2 = Bottom of Seat & Outside Back (Fabric Contrast 2) C.O.M. = 0.75 yds Overall Dimensions: W=19.5" D=21.25" H=37" 	CAS4MCP24	<input type="checkbox"/> <input type="checkbox"/> <input type="checkbox"/> <input type="checkbox"/>	<input type="checkbox"/> <input type="checkbox"/> <input type="checkbox"/> <input type="checkbox"/>	<input type="checkbox"/> <input type="checkbox"/> <input type="checkbox"/> <input type="checkbox"/>	<input type="checkbox"/> <input type="checkbox"/>	<input type="checkbox"/> <input type="checkbox"/>	25.00#	\$ 870
CAS4M								
	A	B	C	D	E	F		

HOW TO ORDER

Indicate the following information on order form:

- Quantity of each item.
- Model number, including options. See "How to Build a Model Number".
- Any special service required.

Note: • The indicates that a choice is required.

- The absence of the indicates that no choice is required.
- Alpha-numeric characters in place of indicate that no other alternatives are available.

HOW TO BUILD A MODEL NUMBER

- A** Select basic model.
- B** Select non-contrast or fabric contrast 1.
Refer to ki.com/fabrics.
• For yardage pricing, see Fabric Yardage Pricing page
- C** Select fabric contrast 2.
Refer to ki.com/fabrics.
• For yardage pricing, see Fabric Yardage Pricing page
- D** Select welting color.
Refer to the **Product Color Options** page in this price list.
- E** Select metal finish.
BL - Black
CH - Chrome
CG - Cool Grey
CO - Cottonwood
WG - Warm Grey
Refer to the **Product Color Options** page in this

price list.

- F** Select glide option.
GFT - Felt glides
GNV - Nylon glides

SPECIAL SERVICES

Special Carton Marking

With specially marked information N/C

Shipping

Ships **assembled, FOB Sheboygan, WI 53081, freight prepaid.** Freight class 250.

Specifications and prices are subject to change without prior notice.



Cascha™ Stools - Armless

Stool, Armless, Metal Four-Leg Base, 30" High



Cascha™ Stools - Armless

Stool, Armless, Metal Four-Leg Base, 30" High

MODEL	MODEL NUMBER					Approx. Packaged Weight	Delivered Pricing
	Basic Model	Non-Contrast or Fabric Contrast 1	Fabric Contrast 2	Metal Finish	Glide Option		
 <p>Stool, Armless, Metal Four-Leg Base, 30" High, Non-Contrast</p> <ul style="list-style-type: none"> Fully upholstered with steel legs Fixed cafe height Non-contrast C.O.M = 1 yd Overall Dimensions: W=19.5" D=21.25" H=42.75" 	CAS4MNN30	<input type="checkbox"/> <input type="checkbox"/> <input type="checkbox"/> <input type="checkbox"/>		<input type="checkbox"/> <input type="checkbox"/>	<input type="checkbox"/> <input type="checkbox"/>	26.00#	\$ 760
CAS4M							
 <p>Stool, Armless, Metal Four-Leg Base, 30" High, Contrast</p> <ul style="list-style-type: none"> Fully upholstered with steel legs Fixed cafe height 1 = Top of Seat & Inside Back (Fabric Contrast 1) C.O.M. = 0.5 yds 2 = Bottom of Seat & Outside Back (Fabric Contrast 2) C.O.M. = 0.75 yds Overall Dimensions: W=19.5" D=21.25" H=42.75" 	CAS4MCN30	<input type="checkbox"/> <input type="checkbox"/> <input type="checkbox"/> <input type="checkbox"/>	<input type="checkbox"/> <input type="checkbox"/> <input type="checkbox"/> <input type="checkbox"/>	<input type="checkbox"/> <input type="checkbox"/>	<input type="checkbox"/> <input type="checkbox"/>	26.00#	\$ 785
CAS4M							
	A	B	C	D	E		

HOW TO ORDER

- Indicate the following information on order form:
- Quantity of each item.
 - Model number, including options. See "How To Build a Model Number".
 - Any special service required.

Note:

- The indicates that a choice is required.
- The absence of the indicates that no choice is required.
- Alpha-numeric characters in place of indicate that no other alternatives are available.

HOW TO BUILD A MODEL NUMBER

GNV - Nylon glides

- A** Select basic model.
- B** Select non-contrast or fabric contrast 1.
Refer to ki.com/fabrics.
• For yardage pricing, see Fabric Yardage Pricing page
- C** Select fabric contrast 2.
Refer to ki.com/fabrics.
• For yardage pricing, see Fabric Yardage Pricing page
- D** Select metal finish.
- BL** - Black
- CH** - Chrome
- CG** - Cool Grey
- CO** - Cottonwood
- WG** - Warm Grey
- Refer to the **Product Color Options** page in this price list.
- E** Select glide option.
- GFT** - Felt glides

SPECIAL SERVICES

Special Carton Marking

With specially marked information N/C

Shipping

Ships assembled, FOB Sheboygan, WI 53081, freight prepaid. Freight class 250.

Specifications and prices are subject to change without prior notice.



Cascha™ Stools - Armless

Stool, Armless, Metal Four-Leg Base, 30" High, With Welting



Cascha™ Stools - Armless

Stool, Armless, Metal Four-Leg Base, 30" High, With Welting

MODEL	MODEL NUMBER						Approx. Packaged Weight	Delivered Pricing
	Basic Model	Non-Contrast or Fabric Contrast 1	Fabric Contrast 2	Welting Color	Metal Finish	Glide Option		
 <p>Stool, Armless, Metal Four-Leg Base, 30" High, Non-Contrast, With Welting</p> <ul style="list-style-type: none"> Fully upholstered with steel legs Includes 0.25" contrasting perimeter welt Fixed cafe height Non-contrast C.O.M = 1 yd Overall Dimensions: W=19.5" D=21.25" H=42.75" 	CAS4MNP30	<input type="checkbox"/>		<input type="checkbox"/>	<input type="checkbox"/>	<input type="checkbox"/>	26.00#	\$ 860
CAS4M								
 <p>Stool, Armless, Metal Four-Leg Base, 30" High, Contrast, With Welting</p> <ul style="list-style-type: none"> Fully upholstered with steel legs Includes 0.25" contrasting perimeter welt Fixed cafe height 1 = Top of Seat & Inside Back (Fabric Contrast 1) C.O.M. = 0.5 yds 2 = Bottom of Seat & Outside Back (Fabric Contrast 2) C.O.M. = 0.75 yds Overall Dimensions: W=19.5" D=21.25" H=42.75" 	CAS4MCP30	<input type="checkbox"/>	<input type="checkbox"/>	<input type="checkbox"/>	<input type="checkbox"/>	<input type="checkbox"/>	26.00#	\$ 885
CAS4M								
	A	B	C	D	E	F		

HOW TO ORDER

- Indicate the following information on order form:
- Quantity of each item.
 - Model number, including options. See "How to Build a Model Number".
 - Any special service required.

Note: • The indicates that a choice is required.

- The absence of the indicates that no choice is required.
- Alpha-numeric characters in place of indicate that no other alternatives are available.

HOW TO BUILD A MODEL NUMBER

- A** Select basic model.
- B** Select non-contrast or fabric contrast 1. Refer to ki.com/fabrics.
- For yardage pricing, see Fabric Yardage Pricing page
- C** Select fabric contrast 2. Refer to ki.com/fabrics.
- For yardage pricing, see Fabric Yardage Pricing page
- D** Select welting color. Refer to the **Product Color Options** page in this price list.
- E** Select metal finish.
- BL** - Black
- CH** - Chrome
- CG** - Cool Grey
- CO** - Cottonwood
- WG** - Warm Grey
- Refer to the **Product Color Options** page in this

price list.

- F** Select glide option.
- GFT** - Felt glides
- GNY** - Nylon glides

SPECIAL SERVICES

Special Carton Marking

With specially marked information N/C

Shipping

Ships **assembled, FOB Sheboygan, WI 53081, freight prepaid.** Freight class 250.

Specifications and prices are subject to change without prior notice.



Cascha™ Stools - Armless

Stool, Armless, Wood Four-Leg Base, 24" High



Cascha™ Stools - Armless

Stool, Armless, Wood Four-Leg Base, 24" High

MODEL	MODEL NUMBER						Approx. Packaged Weight	Delivered Pricing
	Basic Model	Non-Contrast or Fabric Contrast 1	Fabric Contrast 2	Wood Finish	Metal Finish	Glide Option		
 <p>Stool, Armless, Wood Four-Leg Base, 24" High, Non-Contrast</p> <ul style="list-style-type: none"> Fully upholstered with ash wood legs & steel foot ring Fixed counter height Non-contrast C.O.M = 1 yd Overall Dimensions: W=19.5" D=21.25" H=37" 	CAS4WNN24	<input type="checkbox"/> <input type="checkbox"/> <input type="checkbox"/> <input type="checkbox"/>		<input type="checkbox"/> <input type="checkbox"/> <input type="checkbox"/>	<input type="checkbox"/> <input type="checkbox"/>	<input type="checkbox"/> <input type="checkbox"/> <input type="checkbox"/>	26.00#	\$ 990
CAS4W								
 <p>Stool, Armless, Wood Four-Leg Base, 24" High, Contrast</p> <ul style="list-style-type: none"> Fully upholstered with ash wood legs & steel foot ring Fixed counter height 1 = Top of Seat & Inside Back (Fabric Contrast 1) C.O.M. = 0.5 yds 2 = Bottom of Seat & Outside Back (Fabric Contrast 2) C.O.M. = 0.75 yds Overall Dimensions: W=19.5" D=21.25" H=37" 	CAS4WCN24	<input type="checkbox"/> <input type="checkbox"/> <input type="checkbox"/> <input type="checkbox"/>	<input type="checkbox"/> <input type="checkbox"/> <input type="checkbox"/> <input type="checkbox"/>	<input type="checkbox"/> <input type="checkbox"/> <input type="checkbox"/>	<input type="checkbox"/> <input type="checkbox"/>	<input type="checkbox"/> <input type="checkbox"/> <input type="checkbox"/>	26.00#	\$ 1015
CAS4W								
	A	B	C	D	E	F		

HOW TO ORDER

Indicate the following information on order form:

- Quantity of each item.
- Model number, including options. See "How To Build a Model Number".
- Any special service required.

Note: • The indicates that a choice is required.

- The absence of the indicates that no choice is required.
- Alpha-numeric characters in place of indicate that no other alternatives are available.

HOW TO BUILD A MODEL NUMBER

A Select basic model.

B Select non-contrast or fabric contrast 1.

Refer to ki.com/fabrics.

- For yardage pricing, see Fabric Yardage Pricing page

C Select fabric contrast 2.

Refer to ki.com/fabrics

- For yardage pricing, see Fabric Yardage Pricing page

D Select wood finish.

AEB - Eclipse Black on Ash

ANA - Natural on Ash

ARY - River Cherry on Ash

Refer to the **Product Color Options** page in this price list.

E Select metal finish.

BL - Black

CH - Chrome

CG - Cool Grey

CO - Cottonwood

WG - Warm Grey

Refer to the **Product Color Options** page in this price list.

F Select glide option.

GFT - Felt glides; add \$16

GNV - Nylon glides; add \$16

GNN - No glides

SPECIAL SERVICES

Special Carton Marking

With specially marked information N/C

Shipping

Ships **assembled, FOB Sheboygan, WI 53081, freight prepaid.** Freight class 250.

Specifications and prices are subject to change without prior notice.



Cascha™ Stools - Armless

Stool, Armless, Wood Four-Leg Base, 24" High, With Welting



Cascha™ Stools - Armless

Stool, Armless, Wood Four-Leg Base, 24" High, With Welting

MODEL	MODEL NUMBER							Approx. Packaged Weight	Delivered Pricing	
	Basic Model	Non-Contrast or Fabric Contrast 1	Fabric Contrast 2	Welting Color	Wood Finish	Metal Finish	Glide Option			
 <p>CAS4W</p> <p>Stool, Armless, Wood Four-Leg Base, 24" High, Non-Contrast, With Welting</p> <ul style="list-style-type: none"> Fully upholstered with ash wood legs & steel foot ring Includes 0.25" contrasting perimeter welt Fixed counter height Non-contrast C.O.M = 1 yd Overall Dimensions: W=19.5" D=21.25" H=37" 	CAS4WNP24	<input type="checkbox"/>		<input type="checkbox"/>	<input type="checkbox"/>	<input type="checkbox"/>	<input type="checkbox"/>	26.00#	\$ 1090	
 <p>CAS4W</p> <p>Stool, Armless, Wood Four-Leg Base, 24" High, Contrast, With Welting</p> <ul style="list-style-type: none"> Fully upholstered with ash wood legs & steel foot ring Includes 0.25" contrasting perimeter welt Fixed counter height 1 = Top of Seat & Inside Back (Fabric Contrast 1) C.O.M. = 0.5 yds 2 = Bottom of Seat & Outside Back (Fabric Contrast 2) C.O.M. = 0.75 yds Overall Dimensions: W=19.5" D=21.25" H=37" 	CAS4WCP24	<input type="checkbox"/>	<input type="checkbox"/>	<input type="checkbox"/>	<input type="checkbox"/>	<input type="checkbox"/>	<input type="checkbox"/>	26.00#	\$ 1115	
		A	B	C	D	E	F	G		

HOW TO ORDER

- Indicate the following information on order form:
- Quantity of each item.
 - Model number, including options. See "How To Build a Model Number".
 - Any special service required.

Note:

- The indicates that a choice is required.
- The absence of the indicates that no choice is required.
- Alpha-numeric characters in place of indicate that no other alternatives are available.

HOW TO BUILD A MODEL NUMBER

- A** Select basic model.
- B** Select non-contrast or fabric contrast 1. Refer to ki.com/fabrics.
 - For yardage pricing, see Fabric Yardage Pricing page
- C** Select fabric contrast 2. Refer to ki.com/fabrics.
 - For yardage pricing, see Fabric Yardage Pricing page
- D** Select welting color. Refer to the **Product Color Options** page in this price list.
- E** Select wood finish.

AEB	- Eclipse Black on Ash
ANA	- Natural on Ash
ARY	- River Cherry on Ash

 Refer to the **Product Color Options** page in this price list.
- F** Select metal finish.

BL	- Black
CH	- Chrome
CG	- Cool Grey
CO	- Cottonwood
WG	- Warm Grey

 Refer to the **Product Color Options** page in this price list.
- G** Select glide option.

GFT	- Felt glides; add \$16
GNV	- Nylon glides; add \$16
GNN	- No glides

SPECIAL SERVICES

Special Carton Marking

With specially marked information N/C

Shipping

Ships **assembled, FOB Sheboygan, WI 53081, freight prepaid.** Freight class 250.

Specifications and prices are subject to change without prior notice.



Cascha™ Stools - Armless

Stool, Armless, Wood Four-Leg Base, 30" High



Cascha™ Stools - Armless

Stool, Armless, Wood Four-Leg Base, 30" High

MODEL	MODEL NUMBER						Approx. Packaged Weight	Delivered Pricing
	Basic Model	Non-Contrast or Fabric Contrast 1	Fabric Contrast 2	Wood Finish	Metal Finish	Glide Option		
 <p>Stool, Armless, Wood Four-Leg Base, 30" High, Non-Contrast</p> <ul style="list-style-type: none"> Fully upholstered with ash wood legs & steel foot ring Fixed cafe height Non-contrast C.O.M = 1 yd Overall Dimensions: W=19.5" D=21.25" H=43" 	CAS4WNN30	<input type="checkbox"/> <input type="checkbox"/> <input type="checkbox"/> <input type="checkbox"/>		<input type="checkbox"/> <input type="checkbox"/> <input type="checkbox"/>	<input type="checkbox"/> <input type="checkbox"/>	<input type="checkbox"/> <input type="checkbox"/> <input type="checkbox"/>	27.00#	\$ 1005
CAS4W								
 <p>Stool, Armless, Wood Four-Leg Base, 30" High, Contrast</p> <ul style="list-style-type: none"> Fully upholstered with ash wood legs & steel foot ring Fixed cafe height 1 = Top of Seat & Inside Back (Fabric Contrast 1) C.O.M. = 0.5 yds 2 = Bottom of Seat & Outside Back (Fabric Contrast 2) C.O.M. = 0.75 yds Overall Dimensions: W=19.5" D=21.25" H=43" 	CAS4WCN30	<input type="checkbox"/> <input type="checkbox"/> <input type="checkbox"/> <input type="checkbox"/>	<input type="checkbox"/> <input type="checkbox"/> <input type="checkbox"/> <input type="checkbox"/>	<input type="checkbox"/> <input type="checkbox"/> <input type="checkbox"/>	<input type="checkbox"/> <input type="checkbox"/>	<input type="checkbox"/> <input type="checkbox"/> <input type="checkbox"/>	27.00#	\$ 1030
CAS4W								
	A	B	C	D	E	F		

HOW TO ORDER

Indicate the following information on order form:

- Quantity of each item.
- Model number, including options. See "How To Build a Model Number".
- Any special service required.

Note: • The indicates that a choice is required.

- The absence of the indicates that no choice is required.
- Alpha-numeric characters in place of indicate that no other alternatives are available.

HOW TO BUILD A MODEL NUMBER

A Select basic model.

B Select non-contrast or fabric contrast 1.

Refer to ki.com/fabrics.

- For yardage pricing, see Fabric Yardage Pricing page

C Select fabric contrast 2.

Refer to ki.com/fabrics

- For yardage pricing, see Fabric Yardage Pricing page

D Select wood finish.

AEB - Eclipse Black on Ash

ANA - Natural on Ash

ARY - River Cherry on Ash

Refer to the **Product Color Options** page in this price list.

E Select metal finish.

BL - Black

CH - Chrome

CG - Cool Grey

CO - Cottonwood

WG - Warm Grey

Refer to the **Product Color Options** page in this price list.

F Select glide option.

GFT - Felt glides; add \$16

GNY - Nylon glides; add \$16

GNN - No glides

SPECIAL SERVICES

Special Carton Marking

With specially marked information N/C

Shipping

Ships assembled, FOB Sheboygan, WI 53081, freight prepaid. Freight class 250.

Specifications and prices are subject to change without prior notice.



Cascha™ Stools - Armless

Stool, Armless, Height Adjustable, Metal Swivel Pedestal Base



Cascha™ Stools - Armless

Stool, Armless, Height Adjustable, Metal Swivel Pedestal Base

MODEL	MODEL NUMBER				Approx. Packaged Weight	Delivered Pricing
	Basic Model	Non-Contrast or Fabric Contrast 1	Fabric Contrast 2	Metal Finish		
 <p>Stool, Armless, Height Adjustable, Metal Swivel Pedestal Base, Non-Contrast</p> <ul style="list-style-type: none"> Fully upholstered steel swivel pedestal base Height Adjustable - nominal seat height range is 20 to 29.5" Non-contrast C.O.M = 1 yd Overall Dimensions: W=19.5" D=21.25" H=32.25 to 41.75" 	CASPDNN	<input type="checkbox"/> <input type="checkbox"/> <input type="checkbox"/> <input type="checkbox"/>		<input type="checkbox"/> <input type="checkbox"/>	43.00#	\$ 970
CASPD						
 <p>Stool, Armless, Height Adjustable, Metal Swivel Pedestal Base, Contrast</p> <ul style="list-style-type: none"> Fully upholstered steel swivel pedestal base Height Adjustable - nominal seat height range is 20 to 29.5" 1 = Top of Seat & Inside Back (Fabric Contrast 1) C.O.M. = 0.5 yds 2 = Bottom of Seat & Outside Back (Fabric Contrast 2) C.O.M. = 0.75 yds Overall Dimensions: W=19.5" D=21.25" H=32.25 to 41.75" 	CASPDNCN	<input type="checkbox"/> <input type="checkbox"/> <input type="checkbox"/> <input type="checkbox"/>	<input type="checkbox"/> <input type="checkbox"/> <input type="checkbox"/> <input type="checkbox"/>	<input type="checkbox"/> <input type="checkbox"/>	43.00#	\$ 995
CASPD						
		A	B	C	D	

HOW TO ORDER

Indicate the following information on order form:

- Quantity of each item.
- Model number, including options. See "How To Build a Model Number".
- Any special service required.

Note: • The indicates that a choice is required.

- The absence of the indicates that no choice is required.
- Alpha-numeric characters in place of indicate that no other alternatives are available.

HOW TO BUILD A MODEL NUMBER

- A** Select basic model.
- B** Select non-contrast or fabric contrast 1. Refer to ki.com/fabrics.
- For yardage pricing, see Fabric Yardage Pricing page
- C** Select fabric contrast 2. Refer to ki.com/fabrics.
- For yardage pricing, see Fabric Yardage Pricing page
- D** Select metal finish.
- | | |
|-----------|--------------|
| BL | - Black |
| CH | - Chrome |
| CG | - Cool Grey |
| CO | - Cottonwood |
| WG | - Warm Grey |
- Refer to the **Product Color Options** page in this price list.

SPECIAL SERVICES

Special Carton Marking

With specially marked information N/C

Shipping

Ships **assembled, FOB Sheboygan, WI 53081, freight prepaid.** Freight class 175.

Specifications and prices are subject to change without prior notice.



Cascha™ Stools - Armless

Stool, Armless, Height Adjustable, Metal Swivel Pedestal Base, With Welting



Cascha™ Stools - Armless

Stool, Armless, Height Adjustable, Metal Swivel Pedestal Base, With Welting

MODEL	MODEL NUMBER					Approx. Packaged Weight	Delivered Pricing
	Basic Model	Non-Contrast or Fabric Contrast 1	Fabric Contrast 2	Welting Color	Metal Finish		
 CASPD Stool, Armless, Height Adjustable, Metal Swivel Pedestal Base, Non-Contrast, With Welting <ul style="list-style-type: none"> Fully upholstered steel swivel pedestal base Includes 0.25" contrasting perimeter welt Height Adjustable - nominal seat height range is 20 to 29.5" Non-contrast C.O.M = 1 yd Overall Dimensions: W=19.5" D=21.25" H=32.25 to 41.75" 	CASPDNP	<input type="checkbox"/> <input type="checkbox"/> <input type="checkbox"/> <input type="checkbox"/>		<input type="checkbox"/> <input type="checkbox"/> <input type="checkbox"/> <input type="checkbox"/>	<input type="checkbox"/> <input type="checkbox"/>	43.00#	\$ 1070
 CASPD Stool, Armless, Height Adjustable, Metal Swivel Pedestal Base, Contrast, With Welting <ul style="list-style-type: none"> Fully upholstered steel swivel pedestal base Includes 0.25" contrasting perimeter welt Height Adjustable - nominal seat height range is 20 to 29.5" 1 = Top of Seat & Inside Back (Fabric Contrast 1) C.O.M. = 0.5 yds 2 = Bottom of Seat & Outside Back (Fabric Contrast 2) C.O.M. = 0.75 yds Overall Dimensions: W=19.5" D=21.25" H=32.25 to 41.75" 	CASPDPCP	<input type="checkbox"/> <input type="checkbox"/> <input type="checkbox"/> <input type="checkbox"/>	<input type="checkbox"/> <input type="checkbox"/> <input type="checkbox"/> <input type="checkbox"/>	<input type="checkbox"/> <input type="checkbox"/> <input type="checkbox"/> <input type="checkbox"/>	<input type="checkbox"/> <input type="checkbox"/>	43.00#	\$ 1095
	A	B	C	D	E		

HOW TO ORDER

Indicate the following information on order form:

- Quantity of each item.
- Model number, including options. See "How To Build a Model Number".
- Any special service required.

Note: • The indicates that a choice is required.

- The absence of the indicates that no choice is required.
- Alpha-numeric characters in place of indicate that no other alternatives are available.

HOW TO BUILD A MODEL NUMBER

price list.

- A** Select basic model.
- B** Select non-contrast or fabric contrast 1.
Refer to ki.com/fabrics.
• For yardage pricing, see Fabric Yardage Pricing page
- C** Select fabric contrast 2.
Refer to ki.com/fabrics.
• For yardage pricing, see Fabric Yardage Pricing page
- D** Select welting color.
Refer to the **Product Color Options** page in this price list.
- E** Select metal finish.
BL - Black
CH - Chrome
CG - Cool Grey
CO - Cottonwood
WG - Warm Grey
 Refer to the **Product Color Options** page in this

SPECIAL SERVICES

Special Carton Marking

With specially marked information N/C

Shipping

Ships **assembled, FOB Sheboygan, WI 53081, freight prepaid**. Freight class 175.

Specifications and prices are subject to change without prior notice.



Cascha™ Stools - With Arm

Stool, With Arm, Metal Four-Leg Base, 24" High



Cascha™ Stools - With Arm

Stool, With Arm, Metal Four-Leg Base, 24" High

MODEL	MODEL NUMBER					Approx. Packaged Weight	Delivered Pricing
	Basic Model	Non-Contrast or Fabric Contrast 1	Fabric Contrast 2	Metal Finish	Glide Option		
 <p>Stool, With Arm, Metal Four-Leg Base, 24" High, Non-Contrast</p> <ul style="list-style-type: none"> Fully upholstered with steel legs Fixed counter height Non-contrast C.O.M = 1.25 yds Overall Dimensions: W=23.5" D=21.25" H=37" 	CAR4MNN24	<input type="checkbox"/> <input type="checkbox"/> <input type="checkbox"/> <input type="checkbox"/>		<input type="checkbox"/> <input type="checkbox"/>	<input type="checkbox"/> <input type="checkbox"/>	30.00#	\$ 920
CAR4M							
 <p>Stool, With Arm, Metal Four-Leg Base, 24" High, Contrast</p> <ul style="list-style-type: none"> Fully upholstered with steel legs Fixed counter height 1 = Top of Seat & Inside Back (Fabric Contrast 1) C.O.M. = 1 yd 2 = Bottom of Seat & Outside Back (Fabric Contrast 2) C.O.M. = 0.75 yds Overall Dimensions: W=23.5" D=21.25" H=37" 	CAR4MCN24	<input type="checkbox"/> <input type="checkbox"/> <input type="checkbox"/> <input type="checkbox"/>	<input type="checkbox"/> <input type="checkbox"/> <input type="checkbox"/> <input type="checkbox"/>	<input type="checkbox"/> <input type="checkbox"/>	<input type="checkbox"/> <input type="checkbox"/>	30.00#	\$ 950
CAR4M							
	A	B	C	D	E		

HOW TO ORDER

Indicate the following information on order form:

- Quantity of each item.
- Model number, including options. See "How To Build a Model Number".
- Any special service required.

Note: • The indicates that a choice is required.

- The absence of the indicates that no choice is required.
- Alpha-numeric characters in place of indicate that no other alternatives are available.

HOW TO BUILD A MODEL NUMBER

GNV - Nylon glides

- A** Select basic model.
- B** Select non-contrast or fabric contrast 1.
Refer to ki.com/fabrics.
• For yardage pricing, see Fabric Yardage Pricing page
- C** Select fabric contrast 2.
Refer to ki.com/fabrics.
• For yardage pricing, see Fabric Yardage Pricing page
- D** Select metal finish.
- BL** - Black
- CH** - Chrome
- CG** - Cool Grey
- CO** - Cottonwood
- WG** - Warm Grey
- Refer to the **Product Color Options** page in this price list.
- E** Select glide option.
- GFT** - Felt glides



Cascha™ Stools - With Arm

Stool, With Arm, Metal Four-Leg Base, 24" High, With Welting



Cascha™ Stools - With Arm

Stool, With Arm, Metal Four-Leg Base, 24" High, With Welting

MODEL	MODEL NUMBER						Approx. Packaged Weight	Delivered Pricing
	Basic Model	Non-Contrast or Fabric Contrast 1	Fabric Contrast 2	Welting Color	Metal Finish	Glide Option		
 <p>Stool, With Arm, Metal Four-Leg Base, 24" High, Non-Contrast, With Welting</p> <ul style="list-style-type: none"> Fully upholstered with steel legs Includes 0.25" contrasting perimeter welt Fixed counter height Non-contrast C.O.M = 1.25 yds Overall Dimensions: W=23.5" D=21.25" H=37" 	CAR4MNP24	<input type="checkbox"/> <input type="checkbox"/> <input type="checkbox"/> <input type="checkbox"/>		<input type="checkbox"/> <input type="checkbox"/> <input type="checkbox"/> <input type="checkbox"/>	<input type="checkbox"/> <input type="checkbox"/>	<input type="checkbox"/> <input type="checkbox"/>	30.00#	\$ 1040
CAR4M								
 <p>Stool, With Arm, Metal Four-Leg Base, 24" High, Contrast, With Welting</p> <ul style="list-style-type: none"> Fully upholstered with steel legs Includes 0.25" contrasting perimeter welt Fixed counter height 1 = Top of Seat & Inside Back (Fabric Contrast 1) C.O.M. = 1 yd 2 = Bottom of Seat & Outside Back (Fabric Contrast 2) C.O.M. = 0.75 yds Overall Dimensions: W=23.5" D=21.25" H=37" 	CAR4MCP24	<input type="checkbox"/> <input type="checkbox"/> <input type="checkbox"/> <input type="checkbox"/>	<input type="checkbox"/> <input type="checkbox"/> <input type="checkbox"/> <input type="checkbox"/>	<input type="checkbox"/> <input type="checkbox"/> <input type="checkbox"/> <input type="checkbox"/>	<input type="checkbox"/> <input type="checkbox"/>	<input type="checkbox"/> <input type="checkbox"/>	30.00#	\$ 1070
CAR4M								
	A	B	C	D	E	F		

HOW TO ORDER

Indicate the following information on order form:

- Quantity of each item.
- Model number, including options. See "How to Build a Model Number".
- Any special service required.

Note: • The indicates that a choice is required.

- The absence of the indicates that no choice is required.
- Alpha-numeric characters in place of indicate that no other alternatives are available.

HOW TO BUILD A MODEL NUMBER

A Select basic model.

B Select non-contrast or fabric contrast 1.

- Refer to ki.com/fabrics.
- For yardage pricing, see Fabric Yardage Pricing page

C Select fabric contrast 2.

- Refer to ki.com/fabrics
- For yardage pricing, see Fabric Yardage Pricing page

D Select welting color.

- Refer to the **Product Color Options** page in this price list.

E Select metal finish.

- BL** - Black
- CH** - Chrome
- CG** - Cool Grey
- CO** - Cottonwood
- WG** - Warm Grey

Refer to the **Product Color Options** page in this

price list.

F Select glide option.

- GFT** - Felt glides
- GNY** - Nylon glides



Cascha™ Stools - With Arm

Stool, With Arm, Metal Four-Leg Base, 30" High



Cascha™ Stools - With Arm

Stool, With Arm, Metal Four-Leg Base, 30" High

MODEL	MODEL NUMBER					Approx. Packaged Weight	Delivered Pricing
	Basic Model	Non-Contrast or Fabric Contrast 1	Fabric Contrast 2	Metal Finish	Glide Option		
 <p>Stool, With Arm, Metal Four-Leg Base, 30" High, Non-Contrast</p> <ul style="list-style-type: none"> Fully upholstered with ash wood legs & steel foot ring Fixed cafe height Non-contrast C.O.M = 1.25 yds Overall Dimensions: W=23.5" D=21.25" H=42.75" 	CAR4MNN30	<input type="checkbox"/> <input type="checkbox"/> <input type="checkbox"/> <input type="checkbox"/>		<input type="checkbox"/> <input type="checkbox"/>	<input type="checkbox"/> <input type="checkbox"/>	31.00#	\$ 935
CAR4M							
 <p>Stool, With Arm, Metal Four-Leg Base, 30" High, Contrast</p> <ul style="list-style-type: none"> Fully upholstered with ash wood legs & steel foot ring Fixed cafe height 1 = Top of Seat & Inside Back (Fabric Contrast 1) C.O.M. = 1 yd 2 = Bottom of Seat & Outside Back (Fabric Contrast 2) C.O.M. = 0.75 yds Overall Dimensions: W=23.5" D=21.25" H=42.75" 	CAR4MCN30	<input type="checkbox"/> <input type="checkbox"/> <input type="checkbox"/> <input type="checkbox"/>	<input type="checkbox"/> <input type="checkbox"/> <input type="checkbox"/> <input type="checkbox"/>	<input type="checkbox"/> <input type="checkbox"/>	<input type="checkbox"/> <input type="checkbox"/>	31.00#	\$ 965
CAR4M							
	A	B	C	D	E		

HOW TO ORDER

Indicate the following information on order form:

- Quantity of each item.
- Model number, including options. See "How To Build a Model Number".
- Any special service required.

Note: • The indicates that a choice is required.

- The absence of the indicates that no choice is required.
- Alpha-numeric characters in place of indicate that no other alternatives are available.

HOW TO BUILD A MODEL NUMBER

GNV - Nylon glides

- A** Select basic model.
- B** Select non-contrast or fabric contrast 1.
Refer to ki.com/fabrics.
• For yardage pricing, see Fabric Yardage Pricing page
- C** Select fabric contrast 2.
Refer to ki.com/fabrics.
• For yardage pricing, see Fabric Yardage Pricing page
- D** Select metal finish.
- BL** - Black
- CH** - Chrome
- CG** - Cool Grey
- CO** - Cottonwood
- WG** - Warm Grey
- Refer to the **Product Color Options** page in this price list.
- E** Select glide option.
- GFT** - Felt glides



Cascha™ Stools - With Arm

Stool, With Arm, Wood Four-Leg Base, 24" High



Cascha™ Stools - With Arm

Stool, With Arm, Wood Four-Leg Base, 24" High

MODEL	MODEL NUMBER						Approx. Packaged Weight	Delivered Pricing
	Basic Model	Non-Contrast or Fabric Contrast 1	Fabric Contrast 2	Wood Finish	Metal Finish	Glide Option		
 <p>Stool, With Arm, Wood Four-Leg Base, 24" High, Non-Contrast</p> <ul style="list-style-type: none"> Fully upholstered with ash wood legs & steel foot ring Fixed counter height Non-contrast C.O.M = 1.25 yds Overall Dimensions: W=23.5" D=21.25" H=37" 	CAR4WNN24	<input type="checkbox"/> <input type="checkbox"/> <input type="checkbox"/> <input type="checkbox"/>		<input type="checkbox"/> <input type="checkbox"/> <input type="checkbox"/>	<input type="checkbox"/> <input type="checkbox"/>	<input type="checkbox"/> <input type="checkbox"/> <input type="checkbox"/>	31.00#	\$ 1165
CAR4W								
 <p>Stool, With Arm, Wood Four-Leg Base, 24" High, Contrast</p> <ul style="list-style-type: none"> Fully upholstered with ash wood legs & steel foot ring Fixed counter height 1 = Top of Seat & Inside Back (Fabric Contrast 1) C.O.M. = 1 yd 2 = Bottom of Seat & Outside Back (Fabric Contrast 2) C.O.M. = 0.75 yds Overall Dimensions: W=23.5" D=21.25" H=37" 	CAR4WCN24	<input type="checkbox"/> <input type="checkbox"/> <input type="checkbox"/> <input type="checkbox"/>	<input type="checkbox"/> <input type="checkbox"/> <input type="checkbox"/> <input type="checkbox"/>	<input type="checkbox"/> <input type="checkbox"/> <input type="checkbox"/>	<input type="checkbox"/> <input type="checkbox"/>	<input type="checkbox"/> <input type="checkbox"/> <input type="checkbox"/>	31.00#	\$ 1195
CAR4W								
	A	B	C	D	E	F		

HOW TO ORDER

Indicate the following information on order form:

- Quantity of each item.
- Model number, including options. See "How To Build a Model Number".
- Any special service required.

Note: • The indicates that a choice is required.

- The absence of the indicates that no choice is required.
- Alpha-numeric characters in place of indicate that no other alternatives are available.

HOW TO BUILD A MODEL NUMBER

A Select basic model.

B Select non-contrast or fabric contrast 1.

Refer to ki.com/fabrics.

- For yardage pricing, see Fabric Yardage Pricing page

C Select fabric contrast 2.

Refer to ki.com/fabrics

- For yardage pricing, see Fabric Yardage Pricing page

D Select wood finish.

AEB - Eclipse Black on Ash

ANA - Natural on Ash

ARY - River Cherry on Ash

Refer to the **Product Color Options** page in this price list.

E Select metal finish.

BL - Black

CH - Chrome

CG - Cool Grey

CO - Cottonwood

WG - Warm Grey

Refer to the **Product Color Options** page in this price list.

F Select glide option.

GFT - Felt glides; add \$16

GNV - Nylon glides; add \$16

GNN - No glides



Cascha™ Stools - With Arm

Stool, With Arm, Wood Four-Leg Base, 30" High



Cascha™ Stools - With Arm

Stool, With Arm, Wood Four-Leg Base, 30" High

MODEL	MODEL NUMBER						Approx. Packaged Weight	Delivered Pricing
	Basic Model	Non-Contrast or Fabric Contrast 1	Fabric Contrast 2	Wood Finish	Metal Finish	Glide Option		
 <p>Stool, With Arm, Wood Four-Leg Base, 30" High, Non-Contrast</p> <ul style="list-style-type: none"> Fully upholstered with ash wood legs & steel foot ring Fixed cafe height Non-contrast C.O.M = 1.25 yds Overall Dimensions: W=23.5" D=21.25" H=43" 	CAR4WNN30	<input type="checkbox"/> <input type="checkbox"/> <input type="checkbox"/> <input type="checkbox"/>		<input type="checkbox"/> <input type="checkbox"/> <input type="checkbox"/>	<input type="checkbox"/> <input type="checkbox"/>	<input type="checkbox"/> <input type="checkbox"/> <input type="checkbox"/>	32.00#	\$ 1180
CAR4W								
 <p>Stool, With Arm, Wood Four-Leg Base, 30" High, Contrast</p> <ul style="list-style-type: none"> Fully upholstered with ash wood legs & steel foot ring Fixed cafe height 1 = Top of Seat & Inside Back (Fabric Contrast 1) C.O.M. = 1 yd 2 = Bottom of Seat & Outside Back (Fabric Contrast 2) C.O.M. = 0.75 yds Overall Dimensions: W=23.5" D=21.25" H=43" 	CAR4WCN30	<input type="checkbox"/> <input type="checkbox"/> <input type="checkbox"/> <input type="checkbox"/>	<input type="checkbox"/> <input type="checkbox"/> <input type="checkbox"/> <input type="checkbox"/>	<input type="checkbox"/> <input type="checkbox"/> <input type="checkbox"/>	<input type="checkbox"/> <input type="checkbox"/>	<input type="checkbox"/> <input type="checkbox"/> <input type="checkbox"/>	32.00#	\$ 1210
CAR4W								
	A	B	C	D	E	F		

HOW TO ORDER

Indicate the following information on order form:

- Quantity of each item.
- Model number, including options. See "How To Build a Model Number".
- Any special service required.

Note: • The indicates that a choice is required.

- The absence of the indicates that no choice is required.
- Alpha-numeric characters in place of indicate that no other alternatives are available.

HOW TO BUILD A MODEL NUMBER

A Select basic model.

B Select non-contrast or fabric contrast 1. Refer to ki.com/fabrics.

- For yardage pricing, see Fabric Yardage Pricing page

C Select fabric contrast 2.

- Refer to ki.com/fabrics
- For yardage pricing, see Fabric Yardage Pricing page

D Select wood finish.

AEB - Eclipse Black on Ash
ANA - Natural on Ash
ARY - River Cherry on Ash

Refer to the **Product Color Options** page in this price list.

E Select metal finish.

BL - Black
CH - Chrome
CG - Cool Grey

CO - Cottonwood

WG - Warm Grey

Refer to the **Product Color Options** page in this price list.

F Select glide option.

GFT - Felt glides; add \$16
GNY - Nylon glides; add \$16
GNN - No glides



Cascha™ Stools - With Arm

Stool, With Arm, Height Adjustable, Metal Swivel Pedestal Base



Cascha™ Stools - With Arm

Stool, With Arm, Height Adjustable, Metal Swivel Pedestal Base

MODEL	MODEL NUMBER				Approx. Packaged Weight	Delivered Pricing
	Basic Model	Non-Contrast or Fabric Contrast 1	Fabric Contrast 2	Metal Finish		
 <p>CARP</p> <p>Stool, With Arm, Height Adjustable, Metal Swivel Pedestal Base, Non-Contrast</p> <ul style="list-style-type: none"> Fully upholstered steel swivel pedestal base Height Adjustable - nominal seat height range is 20 to 29.5" Non-contrast C.O.M = 1.25 yds Overall Dimensions: W=23.5" D=21.25" H=32.25 to 41.75" 	CARPDNN	<input type="checkbox"/> <input type="checkbox"/> <input type="checkbox"/> <input type="checkbox"/>		<input type="checkbox"/> <input type="checkbox"/>	48.00#	\$ 1145
 <p>CARP</p> <p>Stool, With Arm, Height Adjustable, Metal Swivel Pedestal Base, Contrast</p> <ul style="list-style-type: none"> Fully upholstered steel swivel pedestal base Height Adjustable - nominal seat height range is 20 to 29.5" 1 = Top of Seat & Inside Back (Fabric Contrast 1) C.O.M. = 1 yd 2 = Bottom of Seat & Outside Back (Fabric Contrast 2) C.O.M. = 0.75 yds Overall Dimensions: W=23.5" D=21.25" H=32.25 to 41.75" 	CARPDNC	<input type="checkbox"/> <input type="checkbox"/> <input type="checkbox"/> <input type="checkbox"/>	<input type="checkbox"/> <input type="checkbox"/> <input type="checkbox"/> <input type="checkbox"/>	<input type="checkbox"/> <input type="checkbox"/>	48.00#	\$ 1175
		A	B	C	D	

HOW TO ORDER

Indicate the following information on order form:

- Quantity of each item.
- Model number, including options. See "How To Build a Model Number".
- Any special service required.

Note: • The indicates that a choice is required.

- The absence of the indicates that no choice is required.
- Alpha-numeric characters in place of indicate that no other alternatives are available.

HOW TO BUILD A MODEL NUMBER

- A** Select basic model.
- B** Select non-contrast or fabric contrast 1. Refer to ki.com/fabrics.
- For yardage pricing, see Fabric Yardage Pricing page
- C** Select fabric contrast 2. Refer to ki.com/fabrics.
- For yardage pricing, see Fabric Yardage Pricing page
- D** Select metal finish.
- | | |
|-----------|--------------|
| BL | - Black |
| CH | - Chrome |
| CG | - Cool Grey |
| CO | - Cottonwood |
| WG | - Warm Grey |
- Refer to the **Product Color Options** page in this price list.

SPECIAL SERVICES

Special Carton Marking

With specially marked information N/C

Shipping

Ships **assembled, FOB Sheboygan, WI 53081, freight prepaid.** Freight class 175.

Specifications and prices are subject to change without prior notice.



Cascha™ Stools - With Arm

Stool, With Arm, Height Adjustable, Metal Swivel Pedestal Base, With Welting



Cascha™ Stools - With Arm

Stool, With Arm, Height Adjustable, Metal Swivel Pedestal Base, With Welting

MODEL	MODEL NUMBER					Approx. Packaged Weight	Delivered Pricing
	Basic Model	Non-Contrast or Fabric Contrast 1	Fabric Contrast 2	Welting Color	Metal Finish		
 <p>CARPD</p> <p>Stool, With Arm, Height Adjustable, Metal Swivel Pedestal Base, Non-Contrast, With Welting</p> <ul style="list-style-type: none"> Fully upholstered steel swivel pedestal base Includes 0.25" contrasting perimeter welt Height Adjustable - nominal seat height range is 20 to 29.5" Non-contrast C.O.M = 1.25 yds Overall Dimensions: W=23.5" D=21.25" H=32.25 to 41.75" 	CARPDNP	□□□□		□□□□	□□	48.00#	\$ 1265
 <p>CARPD</p> <p>Stool, With Arm, Height Adjustable, Metal Swivel Pedestal Base, Contrast, With Welting</p> <ul style="list-style-type: none"> Fully upholstered steel swivel pedestal base Includes 0.25" contrasting perimeter welt Height Adjustable - nominal seat height range is 20 to 29.5" 1 = Top of Seat & Inside Back (Fabric Contrast 1) C.O.M. = 1 yd 2 = Bottom of Seat & Outside Back (Fabric Contrast 2) C.O.M. = 0.75 yds Overall Dimensions: W=23.5" D=21.25" H=32.25 to 41.75" 	CARPDPCP	□□□□	□□□□	□□□□	□□	48.00#	\$ 1295
	A	B	C	D	E		

HOW TO ORDER

- Indicate the following information on order form:
- Quantity of each item.
 - Model number, including options. See "How To Build a Model Number".
 - Any special service required.

Note:

- The indicates that a choice is required.
- The absence of the indicates that no choice is required.
- Alpha-numeric characters in place of indicate that no other alternatives are available.

HOW TO BUILD A MODEL NUMBER

price list.

- A** Select basic model.
- B** Select non-contrast or fabric contrast 1.
Refer to ki.com/fabrics.
• For yardage pricing, see Fabric Yardage Pricing page
- C** Select fabric contrast 2.
Refer to ki.com/fabrics.
• For yardage pricing, see Fabric Yardage Pricing page
- D** Select welting color.
Refer to the **Product Color Options** page in this price list.
- E** Select metal finish.
- BL** - Black _____
- CH** - Chrome _____
- CG** - Cool Grey _____
- CO** - Cottonwood _____
- WG** - Warm Grey _____
- Refer to the **Product Color Options** page in this

SPECIAL SERVICES

Special Carton Marking



With specially marked information N/C

Shipping

Ships assembled, FOB Sheboygan, WI 53081, freight prepaid. Freight class 175.

Specifications and prices are subject to change without prior notice.

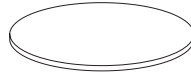

MODEL	MODEL NUMBER			Approx. Packaged Weight	Delivered Pricing	Laminate Grade 2 add to list price	Laminate Grade 3 add to list price
	Basic Model	Edge Color	Surface Finish				
 <p>Round Table Top, 24"Dia, 73P Edge</p> <ul style="list-style-type: none"> Includes laminate top ONLY - 0.75" thick w/ 73P edge Mounting hardware is included w/ table base which MUST BE SPECIFIED SEPARATELY & field installed Basic tools required Overall Dimensions of Table Top: Dia=24" H= 0.75" 	CATRD24/73P	<input type="checkbox"/>	<input type="checkbox"/>	15.00#	\$ 255	\$ 19	\$ 120
CATRD							
 <p>Round Table Top, 24"Dia, Knife Edge</p> <ul style="list-style-type: none"> Includes laminate top ONLY - 0.75" thick w/ Knife edge (KN3) Mounting hardware is included w/ table base which MUST BE SPECIFIED SEPARATELY & field installed Basic tools required Overall Dimensions of Table Top: Dia=24" H= 0.75" 	CATRD24/KN3	<input type="checkbox"/>	<input type="checkbox"/>	15.00#	\$ 315	\$ 19	\$ 120
CATRD							

A **B** **C**

HOW TO ORDER

- Indicate the following information on order form:
- Quantity of each item.
 - Model number, including options. See "How To Build a Model Number".
 - Any special service required.

Note:

- The indicates that a choice is required.
- The absence of the indicates that no choice is required.
- Alpha-numeric characters in place of indicate that no other alternatives are available.

HOW TO BUILD A MODEL NUMBER

- A** Select basic model.
- B** Select edge color. Refer to the **Product Color Options** page in this price list.
- C** Select surface finish. Refer to the **Product Color Options** page in this price list.

SPECIAL SERVICES

Special Carton Marking

With specially marked information N/C

Shipping

Ships **knocked down, FOB Bonduel, WI 54107, freight prepaid.** Freight class 60.

Specifications and prices are subject to change without prior notice.

Cascha™ Tables - Bases

Coffee Table and Side Table, Wood Base



Cascha™ Tables - Bases

Coffee Table and Side Table, Wood Base

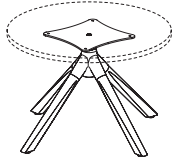
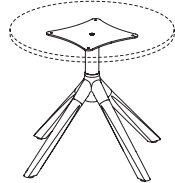
MODEL	MODEL NUMBER				Approx. Packaged Weight	Delivered Pricing
	Basic Model	Wood Finish	Metal Finish	Glide Option		
 Coffee Table, Wood Base ONLY for 16"H Table <ul style="list-style-type: none"> Includes ash wood & aluminum table base & mounting hardware ONLY Table top MUST BE SPECIFIED SEPARATELY (CATRD24/73P or CATRD24/KN3) & field installed Basic tools required Overall Dimensions with Attached Tabletop: W=25.75" D=25.75" H=16.25" 	CABXW16	<input type="checkbox"/> <input type="checkbox"/>	<input type="checkbox"/> <input type="checkbox"/>	<input type="checkbox"/> <input type="checkbox"/>	13.00#	\$ 609
 Side Table, Wood Base ONLY for 20"H Table <ul style="list-style-type: none"> Includes ash wood & aluminum table base & mounting hardware ONLY Table top MUST BE SPECIFIED SEPARATELY (CATRD24/73P or CATRD24/KN3) & field installed Basic tools required Overall Dimensions with Attached Tabletop: W=25.75" D=25.75" H=20.25" 	CABXW20	<input type="checkbox"/> <input type="checkbox"/>	<input type="checkbox"/> <input type="checkbox"/>	<input type="checkbox"/> <input type="checkbox"/>	13.00#	\$ 636

A **B** **C** **D**

HOW TO ORDER

Indicate the following information on order form:

- Quantity of each item.
- Model number, including options. See "How To Build a Model Number".
- Any special service required.

Note: • The indicates that a choice is required.

- The absence of the indicates that no choice is required.
- Alpha-numeric characters in place of indicate that no other alternatives are available.

HOW TO BUILD A MODEL NUMBER

- A** Select basic model.
- B** Select wood finish.
Refer to the **Product Color Options** page in this price list.
- C** Select metal finish.
BL - Black
CG - Cool Grey
CO - Cottonwood
PA - Polished Aluminum
WG - Warm Grey
Refer to the **Product Color Options** page in this price list.
- D** Select glide option.
GFT - Felt glides; add \$16
GNY - Nylon glides; add \$16
GNN - No glides

SPECIAL SERVICES

Special Carton Marking

With specially marked information N/C

Shipping

Ships **assembled, FOB Sheboygan, WI 53081, freight prepaid.** Freight class 175.

Specifications and prices are subject to change without prior notice.

Cascha™ Tables - Bases

Standard Height, Counter Height and Cafe Height Tables, Wood Base



Cascha™ Tables - Bases

Standard Height, Counter Height and Cafe Height Tables, Wood Base

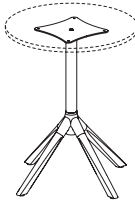
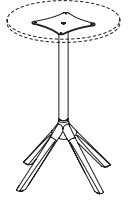
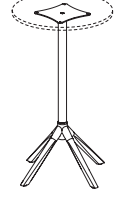
MODEL	MODEL NUMBER				Approx. Packaged Weight	Delivered Pricing
	Basic Model	Wood Finish	Metal Finish	Glide Option		
 <p>Standard Height Table, Wood Base ONLY for 29"H Table</p> <ul style="list-style-type: none"> Includes ash wood & aluminum table base & mounting hardware ONLY Table top MUST BE SPECIFIED SEPARATELY (CATRD24/73P or CATRD24/KN3) & field installed Basic tools required Overall Dimensions with Attached Tabletop: W=25.75" D=25.75" H=29" 	CABXW29	<input type="checkbox"/> <input type="checkbox"/> <input type="checkbox"/>	<input type="checkbox"/> <input type="checkbox"/>	<input type="checkbox"/> <input type="checkbox"/> <input type="checkbox"/>	14.00#	\$ 672
CABXW						
 <p>Counter Height Table, Wood Base ONLY for 36"H Table</p> <ul style="list-style-type: none"> Includes ash wood & aluminum table base & mounting hardware ONLY Table top MUST BE SPECIFIED SEPARATELY (CATRD24/73P or CATRD24/KN3) & field installed Basic tools required Overall Dimensions with Attached Tabletop: W=25.75" D=25.75" H=36" 	CABXW36	<input type="checkbox"/> <input type="checkbox"/> <input type="checkbox"/>	<input type="checkbox"/> <input type="checkbox"/>	<input type="checkbox"/> <input type="checkbox"/> <input type="checkbox"/>	14.00#	\$ 704
CABXW						
 <p>Cafe Height Table, Wood Base ONLY for 42"H Table</p> <ul style="list-style-type: none"> Includes ash wood & aluminum table base & mounting hardware ONLY Table top MUST BE SPECIFIED SEPARATELY (CATRD24/73P or CATRD24/KN3) & field installed Basic tools required Overall Dimensions with Attached Tabletop: W=25.75" D=25.75" H=42" 	CABXW42	<input type="checkbox"/> <input type="checkbox"/> <input type="checkbox"/>	<input type="checkbox"/> <input type="checkbox"/>	<input type="checkbox"/> <input type="checkbox"/> <input type="checkbox"/>	15.00#	\$ 735
CABXW						
		A	B	C	D	

HOW TO ORDER

Indicate the following information on order form:

- Quantity of each item.
- Model number, including options. See "How To Build a Model Number".
- Any special service required.

Note: • The indicates that a choice is required.

- The absence of the indicates that no choice is required.
- Alpha-numeric characters in place of indicate that no other alternatives are available.

HOW TO BUILD A MODEL NUMBER

A Select basic model.**B** Select wood finish.

AEB - Eclipse Black on Ash
ANA - Natural on Ash
ARY - River Cherry on Ash

Refer to the **Product Color Options** page in this price list.**C** Select metal finish.

BL - Black
CG - Cool Grey
CO - Cottonwood
PA - Polished Aluminum
WG - Warm Grey

Refer to the **Product Color Options** page in this price list.**D** Select glide option.

GFT - Felt glides; add \$16
GNV - Nylon glides; add \$16
GNN - No glides

SPECIAL SERVICES

Special Carton Marking

With specially marked information N/C

Shipping - Standard Height Table Base (CABXW29)Ships **assembled, FOB Sheboygan, WI 53081, freight prepaid.** Freight class 175.

Specifications and prices are subject to change without prior notice.

SPECIAL SERVICES

Special Carton Marking

With specially marked information N/C

Shipping - Counter Height and Cafe Height Table Bases (CABXW36 and CABXW42)Ships **assembled, FOB Sheboygan, WI 53081, freight prepaid.** Freight class 300.

Specifications and prices are subject to change without prior notice.

Cascha™ Lounge Seating

Replacement Lounge Chair Base



Cascha™ Lounge Seating

Replacement Lounge Chair Base

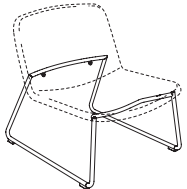
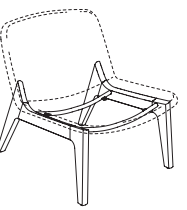
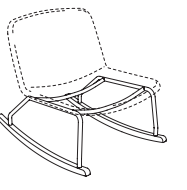
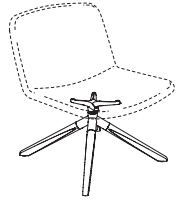
MODEL	MODEL NUMBER				Approx. Packaged Weight	Delivered Pricing
	Basic Model	Wood Finish	Metal Finish	Glide Option		
 <p>Replacement Lounge Chair Sled Base</p> <ul style="list-style-type: none"> Field replaceable steel sled base & mounting hardware for Cascha Lounge Chair (seat & back NOT included) Fixed height Basic tools required 	CAABALS		<input type="checkbox"/>		0.00#	\$ 777
CAABA						
 <p>Replacement Lounge Chair Wood Four-Leg Base</p> <ul style="list-style-type: none"> Field replaceable ash wood four-leg base & mounting hardware for Cascha Lounge Chair (seat & back NOT included) Fixed height Basic tools required 	CAABAL4W	<input type="checkbox"/>		<input type="checkbox"/>	0.00#	\$ 993
CAABA						
 <p>Replacement Lounge Chair Rocking Wood Base</p> <ul style="list-style-type: none"> Field replaceable steel & ash wood rocking base & mounting hardware for Cascha Lounge Chair (seat & back NOT included) Fixed height Basic tools required 	CAABALRW	<input type="checkbox"/>	<input type="checkbox"/>		0.00#	\$ 1029
CAABA						
 <p>Replacement Lounge Chair Wood Swivel Base</p> <ul style="list-style-type: none"> Field replaceable ash wood & steel swivel base & mounting hardware for Cascha Lounge Chair (seat & back NOT included) Fixed height Basic tools required 	CAABAL4K	<input type="checkbox"/>		<input type="checkbox"/>	0.00#	\$ 1103
CAABA						

A **B** **C** **D**

HOW TO ORDER

Indicate the following information on order form:

- Quantity of each item.
- Model number, including options. See "How To Build a Model Number".
- Any special service required.

Note: • The indicates that a choice is required.

- The absence of the indicates that no choice is required.
- Alpha-numeric characters in place of indicate that no other alternatives are available.

HOW TO BUILD A MODEL NUMBER

A Select basic model.

B Select wood finish.

AEB - Eclipse Black on Ash
ANA - Natural on Ash
ARY - River Cherry on Ash

Refer to the **Product Color Options** page in this price list.

C Select metal finish.

BL - Black
CH - Chrome
CG - Cool Grey
CO - Cottonwood
WG - Warm Grey

Refer to the **Product Color Options** page in this price list.

D Select glide option.

GFT - Felt glides; add \$16
GNV - Nylon glides; add \$16
GNN - No glides

Cascha™ Lounge Seating

Replacement Lounge Chair Base



Cascha™ Lounge Seating

Replacement Lounge Chair Base

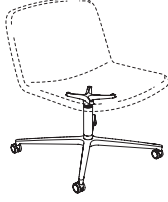
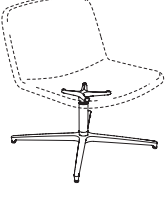
MODEL	MODEL NUMBER			Approx. Packaged Weight	Delivered Pricing
	Basic Model	Metal Finish	Glide Option		
 <p>Replacement Lounge Chair Metal Swivel Base with Casters</p> <ul style="list-style-type: none"> Field replaceable aluminum swivel base & mounting hardware on casters for Cascha Lounge Chair (seat & back NOT included) Fixed height Basic tools required 	CAABALSC	<input type="checkbox"/>		0.00#	\$ 867
CAABA					
 <p>Replacement Lounge Chair Metal Swivel Base</p> <ul style="list-style-type: none"> Field replaceable aluminum swivel base & mounting hardware for Cascha Lounge Chair (seat & back NOT included) Fixed height Basic tools required 	CAABALSG	<input type="checkbox"/>	<input type="checkbox"/>	0.00#	\$ 790
CAABA					

A **B** **C**

HOW TO ORDER

Indicate the following information on order form:

- Quantity of each item.
- Model number, including options. See "How To Build a Model Number".
- Any special service required.

Note: • The indicates that a choice is required.

- The absence of the indicates that no choice is required.
- Alpha-numeric characters in place of indicate that no other alternatives are available.

HOW TO BUILD A MODEL NUMBER

A Select basic model.

B Select metal finish.

BL - Black

PA - Polished Aluminum

Refer to the **Product Color Options** page in this price list.

C Select glide option.

GFT - Felt glides

GNY - Nylon glides

Cascha™ Lounge Seating

Replacement Ottoman Base



Cascha™ Lounge Seating

Replacement Ottoman Base

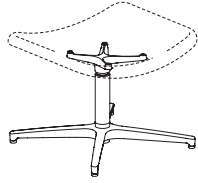
MODEL	MODEL NUMBER			Approx. Packaged Weight	Delivered Pricing
	Basic Model	Metal Finish	Glide Option		
 <p>Replacement Ottoman Metal Swivel Base</p> <ul style="list-style-type: none"> Field replaceable aluminum swivel base & mounting hardware for Cascha Ottoman (seat NOT included) Fixed height Basic tools required 	CAABAFSG	<input type="checkbox"/>	<input type="checkbox"/>	0.0#	\$ 664

CAABA

A**B****C**

HOW TO ORDER

Indicate the following information on order form:

- Quantity of each item.
- Model number, including options. See "How To Build a Model Number".
- Any special service required.

Note: • The indicates that a choice is required.

- The absence of the indicates that no choice is required.
- Alpha-numeric characters in place of indicate that no other alternatives are available.

HOW TO BUILD A MODEL NUMBER

A Select basic model.

B Select metal finish.

BL - Black

PA - Polished Aluminum

Refer to the **Product Color Options** page in this price list.

C Select glide option.

GFT - Felt glides

GNY - Nylon glides



MODEL	MODEL NUMBER			Approx. Packaged Weight	Delivered Pricing
	Basic Model	Metal Finish	Glide Option		
 <p>Replacement Guest Chair Metal Four-Leg Base</p> <ul style="list-style-type: none"> Field replaceable steel four-leg base & mounting hardware for Cascha Guest Chair (seat, back & arms NOT included) Fixed height Basic tools required 	CAABAG4M	<input type="checkbox"/>	<input type="checkbox"/>	0.00#	\$ 342
	A	B	C		

CAABA

HOW TO ORDER

- Indicate the following information on order form:
- Quantity of each item.
 - Model number, including options. See "How To Build a Model Number".
 - Any special service required.

Note:

- The indicates that a choice is required.
- The absence of the indicates that no choice is required.
- Alpha-numeric characters in place of indicate that no other alternatives are available.

HOW TO BUILD A MODEL NUMBER

- A** Select basic model.
- B** Select metal finish.
- | | |
|-----------|--------------|
| BL | - Black |
| CH | - Chrome |
| CG | - Cool Grey |
| CO | - Cottonwood |
| WG | - Warm Grey |
- Refer to the **Product Color Options** page in this price list.
- C** Select glide option.
- | | |
|------------|----------------|
| GFT | - Felt glides |
| GNY | - Nylon glides |



MODEL	MODEL NUMBER			Approx. Packaged Weight	Delivered Pricing
	Basic Model	Wood Finish	Glide Option		
 <p>Replacement Guest Chair Wood Four-Leg Base</p> <ul style="list-style-type: none"> Field replaceable ash wood four-leg base & mounting hardware for Cascha Guest Chair (seat, back & arms NOT included) Fixed height Basic tools required 	CAABAG4W	<input type="checkbox"/> <input type="checkbox"/> <input type="checkbox"/>	<input type="checkbox"/> <input type="checkbox"/> <input type="checkbox"/>	0.0#	\$ 583

CAABA

A **B** **C**

HOW TO ORDER

- Indicate the following information on order form:
- Quantity of each item.
 - Model number, including options. See "How To Build a Model Number".
 - Any special service required.

Note:

- The indicates that a choice is required.
- The absence of the indicates that no choice is required.
- Alpha-numeric characters in place of indicate that no other alternatives are available.

HOW TO BUILD A MODEL NUMBER

- A** Select basic model.
- B** Select wood finish.
- | | |
|------------|------------------------|
| AEB | - Eclipse Black on Ash |
| ANA | - Natural on Ash |
| ARY | - River Cherry on Ash |
- Refer to the **Product Color Options** page in this price list.
- C** Select glide option.
- | | |
|------------|--------------------------|
| GFT | - Felt glides; add \$16 |
| GNY | - Nylon glides; add \$16 |
| GNN | - No glides |

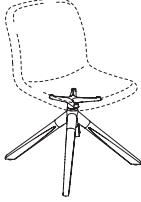

MODEL	MODEL NUMBER				Approx. Packaged Weight	Delivered Pricing
	Basic Model	Wood Finish	Metal Finish	Glide Option		
 <p>Replacement Guest Chair Wood Swivel Base</p> <ul style="list-style-type: none"> Field replaceable ash wood & aluminum swivel base & mounting hardware for Cascha Lounge Chair (seat & back & arms NOT included) Fixed height Basic tools required 	CAABAG4K	<input type="checkbox"/>	<input type="checkbox"/>	<input type="checkbox"/>	0.0#	\$ 667
	A	B	C	D		

CAABA

HOW TO ORDER

- Indicate the following information on order form:
- Quantity of each item.
 - Model number, including options. See "How To Build a Model Number".
 - Any special service required.

Note:

- The indicates that a choice is required.
- The absence of the indicates that no choice is required.
- Alpha-numeric characters in place of indicate that no other alternatives are available.

HOW TO BUILD A MODEL NUMBER

- A** Select basic model.
- B** Select wood finish.

AEB	- Eclipse Black on Ash
ANA	- Natural on Ash
ARY	- River Cherry on Ash



Refer to the **Product Color Options** page in this price list.
- C** Select metal finish.

BL	- Black
PA	- Polished Aluminum

Refer to the **Product Color Options** page in this price list.
- D** Select glide option.

GFT	- Felt glides; add \$16
GNY	- Nylon glides; add \$16
GNN	- No glides



MODEL	MODEL NUMBER			Approx. Packaged Weight	Delivered Pricing
	Basic Model	Metal Finish	Glide Option		
 <p>Replacement Guest Chair Height Adjustable, Metal Swivel Base with Casters</p> <ul style="list-style-type: none"> Field replaceable aluminum swivel base & mounting hardware on casters for Cascha Guest Chair (seat, back & arms NOT included) Height Adjustable - nominal seat height range is 21.25 to 25.75" Basic tools required 	CAABAG4C	<input type="checkbox"/>		0.0#	\$ 531
CAABA					
 <p>Replacement Guest Chair Height Adjustable, Metal Swivel Base</p> <ul style="list-style-type: none"> Field replaceable aluminum swivel base & mounting hardware for Cascha Guest Chair (seat, back & arms NOT included) Height Adjustable - nominal seat height range is 19.5 to 24" Basic tools required 	CAABAG4G	<input type="checkbox"/>	<input type="checkbox"/>	0.0#	\$ 499
CAABA					

A **B** **C**

HOW TO ORDER

- Indicate the following information on order form:
- Quantity of each item.
 - Model number, including options. See "How To Build a Model Number".
 - Any special service required.



Note:

- The indicates that a choice is required.
- The absence of the indicates that no choice is required.
- Alpha-numeric characters in place of indicate that no other alternatives are available.

HOW TO BUILD A MODEL NUMBER

- A** Select basic model.
-
- B** Select metal finish.
- BL** - Black
- PA** - Polished Aluminum
- Refer to the **Product Color Options** page in this price list.
-
- C** Select glide option.
- GFT** - Felt glides
- GNY** - Nylon glides

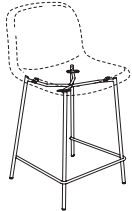
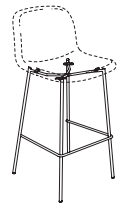

MODEL	MODEL NUMBER			Approx. Packaged Weight	Delivered Pricing
	Basic Model	Metal Finish	Glide Option		
 <p>Replacement Stool Metal Four-Leg Base, 24" High</p> <ul style="list-style-type: none"> Field replaceable steel four-leg base & mounting hardware for Cascha Stool, Overall Seat Height 24" (seat, back & arms NOT included) Fixed counter height Basic tools required 	CAABAS4M24	<input type="checkbox"/>	<input type="checkbox"/>	0.0#	\$ 525
CAABA					
 <p>Replacement Stool Metal Four-Leg Base, 30" High</p> <ul style="list-style-type: none"> Field replaceable steel four-leg base & mounting hardware for Cascha Stool, Overall Seat Height 30" (seat, back & arms NOT included) Fixed café height Basic tools required 	CAABAS4M30	<input type="checkbox"/>	<input type="checkbox"/>	0.0#	\$ 541
CAABA					
 <p>Replacement Stool, Height Adjustable, Metal Swivel Pedestal Base</p> <ul style="list-style-type: none"> Field replaceable steel swivel pedestal base & mounting hardware for Cascha Stool (seat, back & arms NOT included) Height Adjustable - nominal seat height range is 20 to 29.5" Basic tools required 	CAABASPD	<input type="checkbox"/>		0.0#	\$ 776
CAABA					

A **B** **C**

HOW TO ORDER

- Indicate the following information on order form:
- Quantity of each item.
 - Model number, including options. See "How To Build a Model Number".
 - Any special service required.

Note:

- The indicates that a choice is required.
- The absence of the indicates that no choice is required.
- Alpha-numeric characters in place of indicate that no other alternatives are available.

HOW TO BUILD A MODEL NUMBER

- A** Select basic model.
- B** Select metal finish.
- | | |
|-----------|--------------|
| BL | - Black |
| CH | - Chrome |
| CG | - Cool Grey |
| CO | - Cottonwood |
| WG | - Warm Grey |
- Refer to the **Product Color Options** page in this price list.
- C** Select glide option.
- | | |
|------------|----------------|
| GFT | - Felt glides |
| GNY | - Nylon glides |

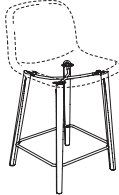
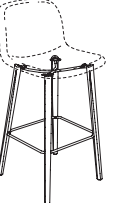

MODEL	MODEL NUMBER				Approx. Packaged Weight	Delivered Pricing
	Basic Model	Wood Finish	Metal Finish	Glide Option		
 <p>Replacement Stool Wood Four-Leg Base, 24" High</p> <ul style="list-style-type: none"> Field replaceable ash wood four-leg base with steel foot ring & mounting hardware for Cascha Stool, Overall Seat Height 24" (seat, back & arms NOT included) Fixed counter height Basic tools required 	CAABAS4W24	<input type="checkbox"/> <input type="checkbox"/>	<input type="checkbox"/> <input type="checkbox"/>	<input type="checkbox"/> <input type="checkbox"/>	0.0#	\$ 783
CAABA						
 <p>Replacement Stool Wood Four-Leg Base, 30" High</p> <ul style="list-style-type: none"> Field replaceable ash wood four-leg base & mounting hardware for Cascha Stool, Overall Seat Height 30" (seat, back & arms NOT included) Fixed café height Basic tools required 	CAABAS4W30	<input type="checkbox"/> <input type="checkbox"/>	<input type="checkbox"/> <input type="checkbox"/>	<input type="checkbox"/> <input type="checkbox"/>	0.0#	\$ 798
CAABA						

A **B** **C** **D**

HOW TO ORDER

- Indicate the following information on order form:
- Quantity of each item.
 - Model number, including options. See "How To Build a Model Number".
 - Any special service required.

Note:

- The indicates that a choice is required.
- The absence of the indicates that no choice is required.
- Alpha-numeric characters in place of indicate that no other alternatives are available.

HOW TO BUILD A MODEL NUMBER

- A** Select basic model.
- B** Select wood finish.
- | | |
|------------|------------------------|
| AEB | - Eclipse Black on Ash |
| ANA | - Natural on Ash |
| ARY | - River Cherry on Ash |
- Refer to the **Product Color Options** page in this price list.
- C** Select metal finish.
- | | |
|-----------|--------------|
| BL | - Black |
| CH | - Chrome |
| CG | - Cool Grey |
| CO | - Cottonwood |
| WG | - Warm Grey |
- Refer to the **Product Color Options** page in this price list.
- D** Select glide option.
- | | |
|------------|--------------------------|
| GFT | - Felt glides; add \$16 |
| GNY | - Nylon glides; add \$16 |
| GNN | - No glides |

Cascha™ Lounge Seating

Replacement Lounge Chair Back and Seat



Cascha™ Lounge Seating

Replacement Lounge Chair Back and Seat

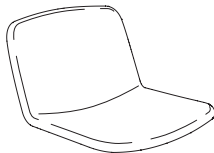
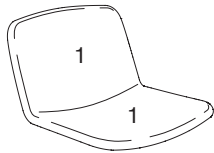
MODEL	MODEL NUMBER			Approx. Packaged Weight	Delivered Pricing
	Basic Model	Non-Contrast or Fabric Contrast 1	Fabric Contrast 2		
 <p>Replacement Lounge Chair, Back and Seat, Armless, Non-Contrast</p> <ul style="list-style-type: none"> Field replaceable fully upholstered seat & back ONLY for Cascha Lounge Chair, Armless (base not included) Repurpose existing mounting hardware *New mounting hardware NOT included Basic tools required Non-contrast C.O.M = 2.5 yds 	CAASHLNN	<input type="checkbox"/> <input type="checkbox"/> <input type="checkbox"/> <input type="checkbox"/>		0.00#	\$ 993
CAASH					
 <p>Replacement Lounge Chair, Back and Seat, Armless, Contrast</p> <ul style="list-style-type: none"> Field replaceable fully upholstered seat & back ONLY for Cascha Lounge Chair, Armless (base not included) Repurpose existing mounting hardware *New mounting hardware NOT included Basic tools required 1 = Top of Seat & Inside Back (Fabric Contrast 1) C.O.M. = 1.25 yds 2 = Bottom of Seat & Outside Back (Fabric Contrast 2) C.O.M. = 1.25 yds 	CAASHLCN	<input type="checkbox"/> <input type="checkbox"/> <input type="checkbox"/> <input type="checkbox"/>	<input type="checkbox"/> <input type="checkbox"/> <input type="checkbox"/> <input type="checkbox"/>	0.00#	\$ 975
CAASH					

A

B

C

HOW TO ORDER

Indicate the following information on order form:

- Quantity of each item.
- Model number, including options. See "How To Build a Model Number".
- Any special service required.

Note: • The indicates that a choice is required.

- The absence of the indicates that no choice is required.
- Alpha-numeric characters in place of indicate that no other alternatives are available.

HOW TO BUILD A MODEL NUMBER

- Select basic model.
- Select non-contrast or fabric contrast 1.
Refer to ki.com/fabrics.
• For yardage pricing, see Fabric Yardage Pricing page
- Select fabric contrast 2.
Refer to ki.com/fabrics.
• For yardage pricing, see Fabric Yardage Pricing page

Cascha™ Lounge Seating

Replacement Lounge Chair Back and Seat



Cascha™ Lounge Seating

Replacement Lounge Chair Back and Seat

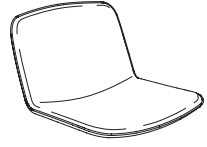
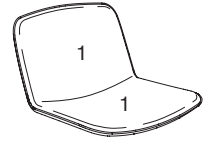
MODEL	MODEL NUMBER				Approx. Packaged Weight	Delivered Pricing
	Basic Model	Non-Contrast or Fabric Contrast 1	Fabric Contrast 2	Welting Color		
 <p>CAASH</p> <p>Replacement Lounge Chair, Back and Seat, Armless, Non-Contrast, With Welting</p> <ul style="list-style-type: none"> Field replaceable fully upholstered seat & back ONLY for Cascha Lounge Chair, Armless (base not included) Repurpose existing mounting hardware *New mounting hardware NOT included Includes 0.25" contrasting perimeter welt Basic tools required Non-contrast C.O.M = 2.5 yds 	CAASHLNP	<input type="checkbox"/> <input type="checkbox"/> <input type="checkbox"/> <input type="checkbox"/>		<input type="checkbox"/> <input type="checkbox"/> <input type="checkbox"/> <input type="checkbox"/>	0.00#	\$ 1119
 <p>CAASH</p> <p>Replacement Lounge Chair, Back and Seat, Armless, Contrast, With Welting</p> <ul style="list-style-type: none"> Field replaceable fully upholstered seat & back ONLY for Cascha Lounge Chair, Armless (base not included) Repurpose existing mounting hardware *New mounting hardware NOT included Includes 0.25" contrasting perimeter welt Basic tools required 1 = Top of Seat & Inside Back (Fabric Contrast 1) C.O.M. = 1.25 yds 2 = Bottom of Seat & Outside Back (Fabric Contrast 2) C.O.M. = 1.25 yds 	CAASHLCP	<input type="checkbox"/> <input type="checkbox"/> <input type="checkbox"/> <input type="checkbox"/>	<input type="checkbox"/> <input type="checkbox"/> <input type="checkbox"/> <input type="checkbox"/>	<input type="checkbox"/> <input type="checkbox"/> <input type="checkbox"/> <input type="checkbox"/>	0.00#	\$ 1095
	A	B	C	D		

HOW TO ORDER

Indicate the following information on order form:

- Quantity of each item.
- Model number, including options. See "How To Build a Model Number".
- Any special service required.



Note: • The indicates that a choice is required.

- The absence of the indicates that no choice is required.
- Alpha-numeric characters in place of indicate that no other alternatives are available.

HOW TO BUILD A MODEL NUMBER

- Select basic model.
- Select non-contrast or fabric contrast 1.
Refer to ki.com/fabrics.
• For yardage pricing, see Fabric Yardage Pricing page
- Select fabric contrast 2.
Refer to ki.com/fabrics.
• For yardage pricing, see Fabric Yardage Pricing page
- Select welting color.
Refer to the **Product Color Options** page in this price list.



MODEL	MODEL NUMBER			Approx. Packaged Weight	Delivered Pricing
	Basic Model	Non-Contrast or Fabric Contrast 1	Fabric Contrast 2		
 CAASH Replacement Ottoman Seat, Non-Contrast <ul style="list-style-type: none"> Field replaceable fully upholstered seat ONLY for Cascha Ottoman (base not included) Repurpose existing mounting hardware *New mounting hardware NOT included Basic tools required Non-contrast C.O.M = 0.75 yds 	CAASHFNN	<input type="checkbox"/> <input type="checkbox"/> <input type="checkbox"/>		0.00#	\$ 396
 CAASH Replacement Ottoman Seat, Contrast <ul style="list-style-type: none"> Field replaceable fully upholstered seat ONLY for Cascha Ottoman (base not included) Repurpose existing mounting hardware *New mounting hardware NOT included Basic tools required 1 = Top of Seat (Fabric Contrast 1) C.O.M. = 0.75 yds 2 = Bottom of Seat (Fabric Contrast 2) C.O.M. = 0.75 yds 	CAASHFCN	<input type="checkbox"/> <input type="checkbox"/> <input type="checkbox"/>	<input type="checkbox"/> <input type="checkbox"/> <input type="checkbox"/>	0.00#	\$ 390

A **B** **C**

HOW TO ORDER

- Indicate the following information on order form:
- Quantity of each item.
 - Model number, including options. See "How To Build a Model Number".
 - Any special service required.



Note:

- The indicates that a choice is required.
- The absence of the indicates that no choice is required.
- Alpha-numeric characters in place of indicate that no other alternatives are available.

HOW TO BUILD A MODEL NUMBER

- A** Select basic model.
- B** Select non-contrast or fabric contrast 1. Refer to ki.com/fabrics.
 - For yardage pricing, see Fabric Yardage Pricing page
- C** Select fabric contrast 2. Refer to ki.com/fabrics.
 - For yardage pricing, see Fabric Yardage Pricing page



MODEL	MODEL NUMBER				Approx. Packaged Weight	Delivered Pricing
	Basic Model	Non-Contrast or Fabric Contrast 1	Fabric Contrast 2	Welting Color		
 CAASH Replacement Ottoman Seat, Non-Contrast, With Welting • Field replaceable fully upholstered seat & back ONLY for Cascha Lounge Chair, Armless (base not included) • Repurpose existing mounting hardware *New mounting hardware NOT included • Includes 0.25" contrasting perimeter welt • Basic tools required • Non-contrast C.O.M = 0.75 yds	CAASHNP	<input type="checkbox"/> <input type="checkbox"/> <input type="checkbox"/> <input type="checkbox"/>		<input type="checkbox"/> <input type="checkbox"/> <input type="checkbox"/> <input type="checkbox"/>	0.00#	\$ 482
 CAASH Replacement Ottoman Seat, Contrast, With Welting • Field replaceable fully upholstered seat & back ONLY for Cascha Lounge Chair, Armless (base not included) • Repurpose existing mounting hardware *New mounting hardware NOT included • Includes 0.25" contrasting perimeter welt • Basic tools required • 1 = Top of Seat (Fabric Contrast 1) C.O.M. = 0.75 yds • 2 = Bottom of Seat (Fabric Contrast 2) C.O.M. = 0.75 yds	CAASHFCP	<input type="checkbox"/> <input type="checkbox"/> <input type="checkbox"/> <input type="checkbox"/>	<input type="checkbox"/> <input type="checkbox"/> <input type="checkbox"/> <input type="checkbox"/>	<input type="checkbox"/> <input type="checkbox"/> <input type="checkbox"/> <input type="checkbox"/>	0.00#	\$ 470

A **B** **C** **D**

HOW TO ORDER

- Indicate the following information on order form:
- Quantity of each item.
 - Model number, including options. See "How To Build a Model Number".
 - Any special service required.

Note:

- The indicates that a choice is required.
- The absence of the indicates that no choice is required.
- Alpha-numeric characters in place of indicate that no other alternatives are available.

HOW TO BUILD A MODEL NUMBER

- A** Select basic model.
- B** Select non-contrast or fabric contrast 1. Refer to ki.com/fabrics
- C** Select fabric contrast 2. Refer to ki.com/fabrics
- D** Select welting color. Refer to the **Product Color Options** page in this price list.

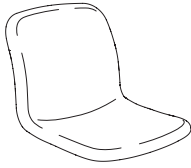
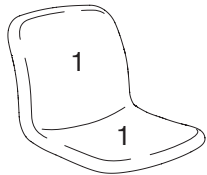

MODEL	MODEL NUMBER			Approx. Packaged Weight	Delivered Pricing
	Basic Model	Non-Contrast or Fabric Contrast 1	Fabric Contrast 2		
 <p>Replacement Guest Chair, Back and Seat, Armless, Non-Contrast</p> <ul style="list-style-type: none"> Field replaceable fully upholstered seat & back ONLY for Cascha Guest Chair, Armless (base not included) Repurpose existing mounting hardware *New mounting hardware NOT included Basic tools required Non-contrast C.O.M = 1.25 yds 	CAASHGNN	<input type="checkbox"/> <input type="checkbox"/> <input type="checkbox"/> <input type="checkbox"/>		0.00#	\$ 762
 <p>Replacement Guest Chair, Back and Seat, Armless, Contrast</p> <ul style="list-style-type: none"> Field replaceable fully upholstered seat & back ONLY for Cascha Guest Chair, Armless (base not included) Repurpose existing mounting hardware *New mounting hardware NOT included Basic tools required 1 = Top of Seat & Inside Back (Fabric Contrast 1) C.O.M. = 0.75 yds 2 = Bottom of Seat & Outside Back (Fabric Contrast 2) C.O.M. = 0.75 yds 	CAASHGCN	<input type="checkbox"/> <input type="checkbox"/> <input type="checkbox"/> <input type="checkbox"/>	<input type="checkbox"/> <input type="checkbox"/> <input type="checkbox"/> <input type="checkbox"/>	0.00#	\$ 750

A **B** **C**

HOW TO ORDER

- Indicate the following information on order form:
- Quantity of each item.
 - Model number, including options. See "How To Build a Model Number".
 - Any special service required.

Note:

- The indicates that a choice is required.
- The absence of the indicates that no choice is required.
- Alpha-numeric characters in place of indicate that no other alternatives are available.

HOW TO BUILD A MODEL NUMBER

- A** Select basic model.
- B** Select non-contrast or fabric contrast 1.
Refer to ki.com/fabrics.
• For yardage pricing, see Fabric Yardage Pricing page
- C** Select fabric contrast 2.
Refer to ki.com/fabrics.
• For yardage pricing, see Fabric Yardage Pricing page

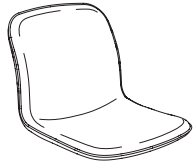
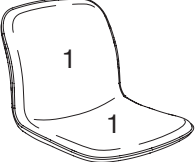

MODEL	MODEL NUMBER				Approx. Packaged Weight	Delivered Pricing
	Basic Model	Non-Contrast or Fabric Contrast 1	Fabric Contrast 2	Welting Color		
 <p>CAASH</p> <p>Replacement Guest Chair, Back and Seat, Armless, Non-Contrast, With Welting</p> <ul style="list-style-type: none"> Field replaceable fully upholstered seat & back ONLY for Cascha Guest Chair, Armless (base not included) Repurpose existing mounting hardware *New mounting hardware NOT included Includes 0.25" contrasting perimeter welt Basic tools required Non-contrast C.O.M = 1.25 yds 	CAASHGNP	<input type="checkbox"/> <input type="checkbox"/> <input type="checkbox"/> <input type="checkbox"/>		<input type="checkbox"/> <input type="checkbox"/> <input type="checkbox"/> <input type="checkbox"/>	0.00#	\$ 867
 <p>CAASH</p> <p>Replacement Guest Chair, Back and Seat, Armless, Contrast, With Welting</p> <ul style="list-style-type: none"> Field replaceable fully upholstered seat & back ONLY for Cascha Guest Chair, Armless (base not included) Repurpose existing mounting hardware *New mounting hardware NOT included Includes 0.25" contrasting perimeter welt Basic tools required 1 = Top of Seat & Inside Back (Fabric Contrast 1) C.O.M. = 0.75 yds 2 = Bottom of Seat & Outside Back (Fabric Contrast 2) C.O.M. = 0.75 yds 	CAASHGCP	<input type="checkbox"/> <input type="checkbox"/> <input type="checkbox"/> <input type="checkbox"/>	<input type="checkbox"/> <input type="checkbox"/> <input type="checkbox"/> <input type="checkbox"/>	<input type="checkbox"/> <input type="checkbox"/> <input type="checkbox"/> <input type="checkbox"/>	0.00#	\$ 850
	A	B	C	D		

HOW TO ORDER

- Indicate the following information on order form:
- Quantity of each item.
 - Model number, including options. See "How To Build a Model Number".
 - Any special service required.

Note:

- The indicates that a choice is required.
- The absence of the indicates that no choice is required.
- Alpha-numeric characters in place of indicate that no other alternatives are available.

HOW TO BUILD A MODEL NUMBER

- A** Select basic model.
- B** Select non-contrast or fabric contrast 1. Refer to ki.com/fabrics.
 - For yardage pricing, see Fabric Yardage Pricing page
- C** Select fabric contrast 2. Refer to ki.com/fabrics.
 - For yardage pricing, see Fabric Yardage Pricing page
- D** Select welting color. Refer to the **Product Color Options** page in this price list.

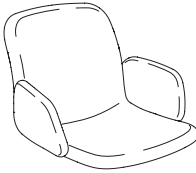
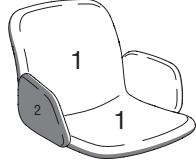

MODEL	MODEL NUMBER			Approx. Packaged Weight	Delivered Pricing
	Basic Model	Non-Contrast or Fabric Contrast 1	Fabric Contrast 2		
 <p>CAASH</p> <p>Replacement Guest Chair, Back and Seat, With Arm, Non-Contrast</p> <ul style="list-style-type: none"> Field replaceable fully upholstered seat & back ONLY for Cascha Guest Chair with Arms (base not included) Repurpose existing mounting hardware *New mounting hardware NOT included Basic tools required Non-contrast C.O.M = 1.5 yds 	CAASHGANN	<input type="checkbox"/> <input type="checkbox"/> <input type="checkbox"/> <input type="checkbox"/>		0.00#	\$ 945
 <p>CAASH</p> <p>Replacement Guest Chair, Back and Seat, With Arm, Contrast</p> <ul style="list-style-type: none"> Field replaceable fully upholstered seat & back ONLY for Cascha Guest Chair, Armless (base not included) Repurpose existing mounting hardware *New mounting hardware NOT included Basic tools required 1 = Top of Seat & Inside Back & Arms (Fabric Contrast 1) C.O.M. = 1 yd 2 = Bottom of Seat & Outside Back & Arms (Fabric Contrast 2) C.O.M. = 1 yd 	CAASHGACN	<input type="checkbox"/> <input type="checkbox"/> <input type="checkbox"/> <input type="checkbox"/>	<input type="checkbox"/> <input type="checkbox"/> <input type="checkbox"/> <input type="checkbox"/>	0.00#	\$ 930

A **B** **C**

HOW TO ORDER

- Indicate the following information on order form:
- Quantity of each item.
 - Model number, including options. See "How To Build a Model Number".
 - Any special service required.

Note:

- The indicates that a choice is required.
- The absence of the indicates that no choice is required.
- Alpha-numeric characters in place of indicate that no other alternatives are available.

HOW TO BUILD A MODEL NUMBER

- A** Select basic model.
- B** Select non-contrast or fabric contrast 1. Refer to ki.com/fabrics.
 - For yardage pricing, see Fabric Yardage Pricing page
- C** Select fabric contrast 2. Refer to ki.com/fabrics.
 - For yardage pricing, see Fabric Yardage Pricing page

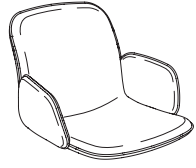
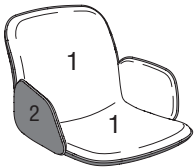

MODEL	MODEL NUMBER				Approx. Packaged Weight	Delivered Pricing
	Basic Model	Non-Contrast or Fabric Contrast 1	Fabric Contrast 2	Welting Color		
 Replacement Guest Chair, Back and Seat, With Arm, Non-Contrast, With Welting <ul style="list-style-type: none"> Field replaceable fully upholstered seat & back ONLY for Cascha Guest Chair with Arms (base not included) Repurpose existing mounting hardware *New mounting hardware NOT included Includes 0.25" contrasting perimeter welt Basic tools required Non-contrast C.O.M = 1.5 yds 	CAASHGANP	<input type="checkbox"/> <input type="checkbox"/> <input type="checkbox"/> <input type="checkbox"/>		<input type="checkbox"/> <input type="checkbox"/> <input type="checkbox"/> <input type="checkbox"/>	0.00#	\$ 1071
 Replacement Guest Chair, Back and Seat, With Arm, Contrast, With Welting <ul style="list-style-type: none"> Field replaceable fully upholstered seat & back ONLY for Cascha Guest Chair with Arms (base not included) Repurpose existing mounting hardware *New mounting hardware NOT included Includes 0.25" contrasting perimeter welt Basic tools required 1 = Top of Seat & Inside Back & Arms (Fabric Contrast 1) C.O.M. = 1 yd 2 = Bottom of Seat & Outside Back & Arms (Fabric Contrast 2) C.O.M. = 1 yd 	CAASHGACP	<input type="checkbox"/> <input type="checkbox"/> <input type="checkbox"/> <input type="checkbox"/>	<input type="checkbox"/> <input type="checkbox"/> <input type="checkbox"/> <input type="checkbox"/>	<input type="checkbox"/> <input type="checkbox"/> <input type="checkbox"/> <input type="checkbox"/>	0.00#	\$ 1050
		A	B	C	D	

HOW TO ORDER

- Indicate the following information on order form:
- Quantity of each item.
 - Model number, including options. See "How To Build a Model Number".
 - Any special service required.

Note:

- The indicates that a choice is required.
- The absence of the indicates that no choice is required.
- Alpha-numeric characters in place of indicate that no other alternatives are available.

HOW TO BUILD A MODEL NUMBER

- A** Select basic model.
- B** Select non-contrast or fabric contrast 1. Refer to ki.com/fabrics.
 - For yardage pricing, see Fabric Yardage Pricing page
- C** Select fabric contrast 2. Refer to ki.com/fabrics.
 - For yardage pricing, see Fabric Yardage Pricing page
- D** Select welting color. Refer to the **Product Color Options** page in this price list.

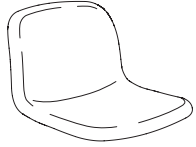
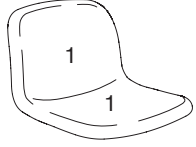

MODEL	MODEL NUMBER			Approx. Packaged Weight	Delivered Pricing
	Basic Model	Non-Contrast or Fabric Contrast 1	Fabric Contrast 2		
 <p>Replacement Stool, Back and Seat, Armless, Non-Contrast</p> <ul style="list-style-type: none"> Field replaceable fully upholstered seat & back ONLY for Cascha Stool, Armless (base not included) Repurpose existing mounting hardware *New mounting hardware NOT included Basic tools required Non-contrast C.O.M = 1 yd 	CAASHSNN	<input type="checkbox"/> <input type="checkbox"/> <input type="checkbox"/> <input type="checkbox"/>		0.00#	\$ 696
CAASH					
 <p>Replacement Stool, Back and Seat, Armless, Contrast</p> <ul style="list-style-type: none"> Field replaceable fully upholstered seat & back ONLY for Cascha Stool, Armless (base not included) Repurpose existing mounting hardware *New mounting hardware NOT included Basic tools required 1 = Top of Seat & Inside Back (Fabric Contrast 1) C.O.M. = 0.5 yds 2 = Bottom of Seat & Outside Back (Fabric Contrast 2) C.O.M. = 0.75 yds 	CAASHSCN	<input type="checkbox"/> <input type="checkbox"/> <input type="checkbox"/> <input type="checkbox"/>	<input type="checkbox"/> <input type="checkbox"/> <input type="checkbox"/> <input type="checkbox"/>	0.00#	\$ 675
CAASH					

A **B** **C**

HOW TO ORDER

- Indicate the following information on order form:
- Quantity of each item.
 - Model number, including options. See "How To Build a Model Number".
 - Any special service required.

Note:

- The indicates that a choice is required.
- The absence of the indicates that no choice is required.
- Alpha-numeric characters in place of indicate that no other alternatives are available.

HOW TO BUILD A MODEL NUMBER

- A** Select basic model.
- B** Select non-contrast or fabric contrast 1. Refer to ki.com/fabrics.
• For yardage pricing, see Fabric Yardage Pricing page
- C** Select fabric contrast 2. Refer to ki.com/fabrics.
• For yardage pricing, see Fabric Yardage Pricing page

Cascha™ Stools - Armless

Replacement Stool Back and Seat, Armless



Cascha™ Stools - Armless

Replacement Stool Back and Seat, Armless

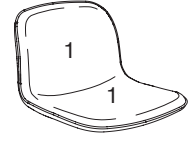
MODEL	MODEL NUMBER				Approx. Packaged Weight	Delivered Pricing
	Basic Model	Non-Contrast or Fabric Contrast 1	Fabric Contrast 2	Welting Color		
 CAASH Replacement Stool, Back and Seat, Armless, Non-Contrast, With Welting • Field replaceable fully upholstered seat & back ONLY for Cascha Stool, Armless (base not included) • Repurpose existing mounting hardware *New mounting hardware NOT included • Includes 0.25" contrasting perimeter welt • Basic tools required • Non-contrast C.O.M = 1 yd	CAASHSNP	<input type="checkbox"/> <input type="checkbox"/> <input type="checkbox"/> <input type="checkbox"/>		<input type="checkbox"/> <input type="checkbox"/> <input type="checkbox"/> <input type="checkbox"/>	0.00#	\$ 803
 CAASH Replacement Stool, Back and Seat, Armless, Contrast, With Welting • Field replaceable fully upholstered seat & back ONLY for Cascha Stool, Armless (base not included) • Repurpose existing mounting hardware *New mounting hardware NOT included • Includes 0.25" contrasting perimeter welt • Basic tools required • 1 = Top of Seat & Inside Back (Fabric Contrast 1) C.O.M. = 0.5 yds • 2 = Bottom of Seat & Outside Back (Fabric Contrast 2) C.O.M. = 0.75 yds	CAASHSCP	<input type="checkbox"/> <input type="checkbox"/> <input type="checkbox"/> <input type="checkbox"/>	<input type="checkbox"/> <input type="checkbox"/> <input type="checkbox"/> <input type="checkbox"/>	<input type="checkbox"/> <input type="checkbox"/> <input type="checkbox"/> <input type="checkbox"/>	0.00#	\$ 775

A **B** **C** **D**

HOW TO ORDER

- Indicate the following information on order form:
- Quantity of each item.
 - Model number, including options. See "How To Build a Model Number".
 - Any special service required.

Note:

- The indicates that a choice is required.
- The absence of the indicates that no choice is required.
- Alpha-numeric characters in place of indicate that no other alternatives are available.

HOW TO BUILD A MODEL NUMBER

- Select basic model.
- Select non-contrast or fabric contrast 1. Refer to ki.com/fabrics
- Select fabric contrast 2. Refer to ki.com/fabrics
- Select welting color. Refer to the **Product Color Options** page in this price list.

Cascha™ Stools - With Arm

Replacement Stool Back and Seat, With Arm



Cascha™ Stools - With Arm

Replacement Stool Back and Seat, With Arm

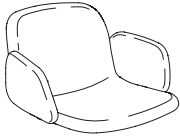
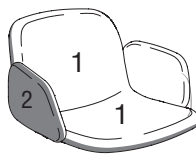
MODEL	MODEL NUMBER			Approx. Packaged Weight	Delivered Pricing
	Basic Model	Non-Contrast or Fabric Contrast 1	Fabric Contrast 2		
 <p>Replacement Stool, Back and Seat, With Arm, Non-Contrast</p> <ul style="list-style-type: none"> Field replaceable fully upholstered seat & back ONLY for Cascha Stool with Arms (base not included) Repurpose existing mounting hardware *New mounting hardware NOT included Basic tools required Non-contrast C.O.M = 1.25 yds 	CAASHSANN	<input type="checkbox"/> <input type="checkbox"/> <input type="checkbox"/> <input type="checkbox"/>		0.00#	\$ 883
CAASH					
 <p>Replacement Stool, Back and Seat, With Arm, Contrast</p> <ul style="list-style-type: none"> Field replaceable fully upholstered seat & back ONLY for Cascha Stool with Arms (base not included) Repurpose existing mounting hardware *New mounting hardware NOT included Basic tools required 1 = Top of Seat & Inside Back (Fabric Contrast 1) C.O.M. = 1 yd 2 = Bottom of Seat & Outside Back (Fabric Contrast 2) C.O.M. = 0.75 yds 	CAASHSACN	<input type="checkbox"/> <input type="checkbox"/> <input type="checkbox"/> <input type="checkbox"/>	<input type="checkbox"/> <input type="checkbox"/> <input type="checkbox"/> <input type="checkbox"/>	0.00#	\$ 855
CAASH					

A **B** **C**

HOW TO ORDER

- Indicate the following information on order form:
- Quantity of each item.
 - Model number, including options. See "How To Build a Model Number".
 - Any special service required.

Note:

- The indicates that a choice is required.
- The absence of the indicates that no choice is required.
- Alpha-numeric characters in place of indicate that no other alternatives are available.

HOW TO BUILD A MODEL NUMBER

- A** Select basic model.
- B** Select non-contrast or fabric contrast 1.
Refer to ki.com/fabrics.
• For yardage pricing, see Fabric Yardage Pricing page
- C** Select fabric contrast 2.
Refer to ki.com/fabrics.
• For yardage pricing, see Fabric Yardage Pricing page

Cascha™ Stools - With Arm

Replacement Stool Back and Seat, With Arm



Cascha™ Stools - With Arm

Replacement Stool Back and Seat, With Arm

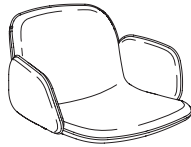
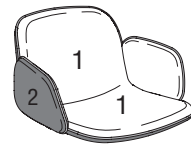
MODEL	MODEL NUMBER				Approx. Packaged Weight	Delivered Pricing
	Basic Model	Non-Contrast or Fabric Contrast 1	Fabric Contrast 2	Welting Color		
 <p>CAASH</p> <p>Replacement Stool, Back and Seat, With Arm, Non-Contrast, With Welting</p> <ul style="list-style-type: none"> Field replaceable fully upholstered seat & back ONLY for Cascha Stool with Arms (base not included) Repurpose existing mounting hardware *New mounting hardware NOT included Includes 0.25" contrasting perimeter welt Basic tools required Non-contrast C.O.M = 1.25 yds 	CAASHSANP	<input type="checkbox"/> <input type="checkbox"/> <input type="checkbox"/> <input type="checkbox"/>		<input type="checkbox"/> <input type="checkbox"/> <input type="checkbox"/> <input type="checkbox"/>	0.00#	\$ 1012
 <p>CAASH</p> <p>Replacement Stool, Back and Seat, Armless, Contrast, With Welting</p> <ul style="list-style-type: none"> Field replaceable fully upholstered seat & back ONLY for Cascha Stool with Arms (base not included) Repurpose existing mounting hardware *New mounting hardware NOT included Includes 0.25" contrasting perimeter welt Basic tools required 1 = Top of Seat & Inside Back (Fabric Contrast 1) C.O.M. = 1 yd 2 = Bottom of Seat & Outside Back (Fabric Contrast 2) C.O.M. = 0.75 yds 	CAASHSACP	<input type="checkbox"/> <input type="checkbox"/> <input type="checkbox"/> <input type="checkbox"/>	<input type="checkbox"/> <input type="checkbox"/> <input type="checkbox"/> <input type="checkbox"/>	<input type="checkbox"/> <input type="checkbox"/> <input type="checkbox"/> <input type="checkbox"/>	0.00#	\$ 975
		A	B	C	D	

HOW TO ORDER

Indicate the following information on order form:

- Quantity of each item.
- Model number, including options. See "How To Build a Model Number".
- Any special service required.

Note: • The indicates that a choice is required.

- The absence of the indicates that no choice is required.
- Alpha-numeric characters in place of indicate that no other alternatives are available.

HOW TO BUILD A MODEL NUMBER

- A** Select basic model.
- B** Select non-contrast or fabric contrast 1.
Refer to ki.com/fabrics.
• For yardage pricing, see Fabric Yardage Pricing page
- C** Select fabric contrast 2.
Refer to ki.com/fabrics.
• For yardage pricing, see Fabric Yardage Pricing page
- D** Select welting color.
Refer to the **Product Color Options** page in this price list.

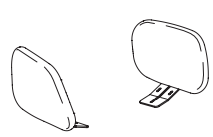
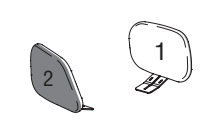

MODEL	MODEL NUMBER			Approx. Packaged Weight	Delivered Pricing
	Basic Model	Non-Contrast or Fabric Contrast 1	Fabric Contrast 2		
 <p>CAAAR</p> <p>Replacement Guest Chair & Stool, Arm Kit, Non-Contrast</p> <ul style="list-style-type: none"> Field replaceable fully upholstered seat & back ONLY for Cascha Guest Chair or Stool (back, seat and base NOT included) Includes mounting hardware Arms can be added to an armless Cascha guest chair or stool or field replaced on a Cascha guest chair or stool with arms. If arms are added to an armless chair or stool, arm attachment brackets will be visible. Basic tools required Non-contrast C.O.M = 0.5 yds 	CAAARNN	<input type="checkbox"/> <input type="checkbox"/> <input type="checkbox"/> <input type="checkbox"/>		0.00#	\$ 250
 <p>CAAAR</p> <p>Replacement Guest Chair & Stool, Arm Kit, Contrast</p> <ul style="list-style-type: none"> Field replaceable fully upholstered seat & back ONLY for Cascha Guest Chair or Stool (back, seat and base NOT included) Includes mounting hardware Arms can be added to an armless Cascha guest chair or stool or field replaced on a Cascha guest chair or stool with arms. If arms are added to an armless chair or stool, arm attachment brackets will be visible. Basic tools required 1 = Inside of Arms (Fabric Contrast 1) C.O.M. = 0.5 yds 2 = Bottom of Arms (Fabric Contrast 2) C.O.M. = 0.5 yds 	CAAARCN	<input type="checkbox"/> <input type="checkbox"/> <input type="checkbox"/> <input type="checkbox"/>	<input type="checkbox"/> <input type="checkbox"/> <input type="checkbox"/> <input type="checkbox"/>	0.00#	\$ 260

A **B** **C**

HOW TO ORDER

- Indicate the following information on order form:
- Quantity of each item.
 - Model number, including options. See "How To Build a Model Number".
 - Any special service required.

Note:

- The indicates that a choice is required.
- The absence of the indicates that no choice is required.
- Alpha-numeric characters in place of indicate that no other alternatives are available.

HOW TO BUILD A MODEL NUMBER

- A** Select basic model.
- B** Select non-contrast or fabric contrast 1. Refer to ki.com/fabrics
- C** Select fabric contrast 2. Refer to ki.com/fabrics

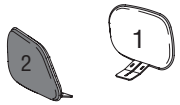

MODEL	MODEL NUMBER				Approx. Packaged Weight	Delivered Pricing
	Basic Model	Non-Contrast or Fabric Contrast 1	Fabric Contrast 2	Welting Color		
 <p>CAAAR</p> <p>Replacement Guest Chair & Stool, Arm Kit, Non-Contrast, With Welting</p> <ul style="list-style-type: none"> Field replaceable fully upholstered seat & back ONLY for Cascha Guest Chair or Stool (back, seat and base NOT included) Includes mounting hardware Arms can be added to an armless Cascha guest chair or stool or field replaced on a Cascha guest chair or stool with arms. If arms are added to an armless chair or stool, arm attachment brackets will be visible. Includes 0.25" contrasting perimeter welt Basic tools required Non-contrast C.O.M = 0.5 yds 	CAAARNP	<input type="checkbox"/> <input type="checkbox"/> <input type="checkbox"/> <input type="checkbox"/>		<input type="checkbox"/> <input type="checkbox"/> <input type="checkbox"/> <input type="checkbox"/>	0.00#	\$ 290
 <p>CAAAR</p> <p>Replacement Guest Chair & Stool, Arm Kit, Contrast, With Welting</p> <ul style="list-style-type: none"> Field replaceable fully upholstered seat & back ONLY for Cascha Guest Chair or Stool (back, seat and base NOT included) Includes mounting hardware Arms can be added to an armless Cascha guest chair or stool or field replaced on a Cascha guest chair or stool with arms. If arms are added to an armless chair or stool, arm attachment brackets will be visible. Includes 0.25" contrasting perimeter welt Basic tools required 1 = Inside of Arms (Fabric Contrast 1) C.O.M. = 0.5 yds 2 = Bottom of Arms (Fabric Contrast 2) C.O.M. = 0.5 yds 	CAAARCP	<input type="checkbox"/> <input type="checkbox"/> <input type="checkbox"/> <input type="checkbox"/>	<input type="checkbox"/> <input type="checkbox"/> <input type="checkbox"/> <input type="checkbox"/>	<input type="checkbox"/> <input type="checkbox"/> <input type="checkbox"/> <input type="checkbox"/>	0.00#	\$ 300

A **B** **C** **D**

HOW TO ORDER

- Indicate the following information on order form:
- Quantity of each item.
 - Model number, including options. See "How To Build a Model Number".
 - Any special service required.

Note:

- The indicates that a choice is required.
- The absence of the indicates that no choice is required.
- Alpha-numeric characters in place of indicate that no other alternatives are available.

HOW TO BUILD A MODEL NUMBER

- A** Select basic model.
- B** Select non-contrast or fabric contrast 1. Refer to ki.com/fabrics.
 - For yardage pricing, see Fabric Yardage Pricing page
- C** Select fabric contrast 2. Refer to ki.com/fabrics.
 - For yardage pricing, see Fabric Yardage Pricing page
- D** Select welting color. Refer to the **Product Color Options** page in this price list.

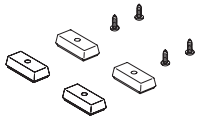
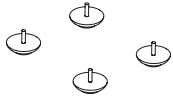
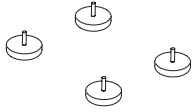

MODEL	MODEL NUMBER		Approx. Packaged Weight	Delivered Pricing
	Basic Model			
 <p>Replacement Sled Base Glide Kit for Lounge Chair</p> <ul style="list-style-type: none"> Field replaceable NYLON glides for SLED BASE on Cascha Lounge Chairs (set of 4) Basic tools required 	CAAGCSL		0.00#	\$ 55
CAAGC				
 <p>Replacement Wood Base Felt Glide Kit for Lounge Chair, Ottoman, Guest Chair, Stool and Tables</p> <ul style="list-style-type: none"> Field replaceable FELT glides for WOOD BASE (Wood Four-Leg & Wood Swivel) on Cascha Lounge Chairs, Ottomans, Guest Chairs, Stools & Tables (set of 4) Basic tools required 	CAAGCWFG		0.00#	\$ 50
CAAGC				
 <p>Replacement Wood Base Nylon Glide Kit for Lounge Chair, Ottoman, Guest Chair, Stool and Tables</p> <ul style="list-style-type: none"> Field replaceable NYLON glides for WOOD BASE (Wood Four-Leg & Wood Swivel) on Cascha Lounge Chairs, Ottomans, Guest Chairs, Stools & Tables (set of 4) Basic tools required 	CAAGCWPG		0.00#	\$ 50
CAAGC				

A

HOW TO ORDER

- Indicate the following information on order form:
- Quantity of each item.
 - Model number, including options. See "How To Build a Model Number".
 - Any special service required.

Note:

- The indicates that a choice is required.
- The absence of the indicates that no choice is required.
- Alpha-numeric characters in place of indicate that no other alternatives are available.

HOW TO BUILD A MODEL NUMBER

- A** Select basic model.

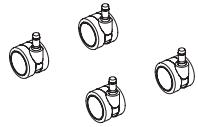
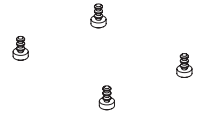
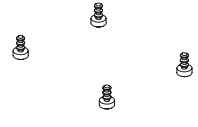

MODEL	MODEL NUMBER		Approx. Packaged Weight	Delivered Pricing
	Basic Model			
 <p>Replacement Metal Swivel Base Caster Kit for Lounge Chair and Guest Chair</p> <ul style="list-style-type: none"> Field replaceable CASTERS for METAL SWIVEL BASE on Cascha Lounge Chairs & Guest Chairs (set of 4) Basic tools required 	CAAGCMSC		0.0#	\$ 80
CAAGC				
 <p>Replacement Metal Swivel Base Felt Glide Kit for Lounge Chair, Ottoman and Guest Chair</p> <ul style="list-style-type: none"> Field replaceable FELT glides for METAL SWIVEL BASE on Cascha Lounge Chairs, Ottomans & Guest Chairs (set of 4) Basic tools required 	CAAGCMSFG		0.0#	\$ 50
CAAGC				
 <p>Replacement Metal Swivel Base Nylon Glide Kit for Lounge Chair, Ottoman and Guest Chair</p> <ul style="list-style-type: none"> Field replaceable NYLON glides for METAL SWIVEL BASE on Cascha Lounge Chairs, Ottomans & Guest Chairs (set of 4) Basic tools required 	CAAGCMSPG		0.0#	\$ 50
CAAGC				

A

HOW TO ORDER

- Indicate the following information on order form:
- Quantity of each item.
 - Model number, including options. See "How To Build a Model Number".
 - Any special service required.



Note:

- The indicates that a choice is required.
- The absence of the indicates that no choice is required.
- Alpha-numeric characters in place of indicate that no other alternatives are available.

HOW TO BUILD A MODEL NUMBER

- A** Select basic model.



MODEL	MODEL NUMBER		Approx. Packaged Weight	Delivered Pricing
	Basic Model			
 <p>Replacement Metal Four-Leg Base Felt Glide Kit for Guest Chair and Stool</p> <ul style="list-style-type: none"> Field replaceable FELT glides for METAL FOUR-LEG BASE on Cascha Guest Chairs & Stools (set of 4) Basic tools required 	CAAGCM4FG		0.0#	\$ 50
CAAGC				
 <p>Replacement Metal Four-Leg Base Nylon Glide Kit for Guest Chair and Stool</p> <ul style="list-style-type: none"> Field replaceable NYLON glides for METAL FOUR-LEG BASE on Cascha Guest Chairs & Stools (set of 4) Basic tools required 	CAAGCM4PG		0.0#	\$ 50
CAAGC				
 <p>Replacement Metal Swivel Pedestal Base Nylon Glide Kit for Height Adjustable Stool</p> <ul style="list-style-type: none"> Field replaceable NYLON glides for METAL SWIVEL PEDESTAL BASE on Cascha Stools (set of 6) Basic tools required 	CAAGCPDPG		0.0#	\$ 40
CAAGC				

A

HOW TO ORDER

- Indicate the following information on order form:
- Quantity of each item.
 - Model number, including options. See "How To Build a Model Number".
 - Any special service required.

Note:

- The indicates that a choice is required.
- The absence of the indicates that no choice is required.
- Alpha-numeric characters in place of indicate that no other alternatives are available.

HOW TO BUILD A MODEL NUMBER

A Select basic model.



1330 BELLEVUE STREET
GREEN BAY, WI 54302
800.424.2432 / KI.COM

KI is a trusted expert for furniture and wall systems around the globe.
USA | CANADA | MEXICO | UK | EUROPE | ASIA | MIDDLE EAST
© 2026 Krueger International, Inc. All Rights Reserved.