



CROSSROADS[®] LIBRARY FURNITURE

PRICE LIST

EFFECTIVE SEPTEMBER 3, 2025
800.424.2432



CrossRoads® Library Furniture		
Technical Specifications		3
Typicals		7
Product Color Options		9
CrossRoads® Study Tables		
Rectangular Tables		10
Square and Round Tables		11
CrossRoads® Study Carrels		
Single Face Carrels		12
Double Face Carrels		13
CrossRoads® Shelving		
42" High Shelving		14
54" High Shelving		15
60" High Shelving		16
72" High Shelving		17
82" High Shelving		18
96" High Shelving		19
CrossRoads® Metal Shelving		
42" Metal Shelving		21
54" Metal Shelving		22
60" Metal Shelving		23
72" Metal Shelving		24
82" Metal Shelving		25
CrossRoads® Periodical Shelving		
42" High Periodical Shelving		26
60" High Periodical Shelving		27
CrossRoads® Accessory Units		
Storage/Accessories		28
Rolling Book Carts		29
CrossRoads® Seating		
Wood Chairs		30



TECHNICAL SPECIFICATIONS

Study Table

Top

Tabletop is 1/4" thick, particleboard core construction with .05" high-pressure laminate facer and .026" backer on the underside. All four edges are banded with a 1/4" thick by 2" wide solid Oak or Maple external knife-edge laminated to core after application of the facer laminate. The edge is beveled to a 1/4" radiused bullnose at the top. The edge band has mitered corners. The underside of the top is fitted with 3/4" x 3/4" solid wood rails screwed to the top.

Legs

The legs are attached to the apron using dovetail joinery, and heavy-gauge metal plate with two heavy-duty anchoring bolts. The legs are 2 1/4" square glued up face-to-face. All of the edges are eased with a 1/4" radius.

Aprons

A 3/4" thick solid Oak or Maple apron rail is fit between the legs on all four sides of the table. The apron is machined to have a full-length arc that is 3 7/8" high at the ends and 2" at the center. The apron rails are screwed to the underside of the top. Optional apron has straight bottom with a beveled face.

Glides

Each leg has a 2" diameter nylon-based adjustable leveling glide with a 1/2" threaded stem.

Worksurface Height

Standard height is 29". Optional 27" or 32" heights may be specified.

Study Carrels (O.P.A.C.)

Top

The worksurface is 1/4" thick by 33 1/2" or 45 1/2" wide by 27 1/2" deep, particleboard core construction with .05" high-pressure laminate facer and .026" backer on the underside. Exposed edge is banded with a 1/4" thick by 2" wide solid Oak or Maple external knife-edge laminated to core after application of the facer laminate. The edge is beveled to a 1/4" radiused bullnose at the top. The worksurface is attached to the end panels and back with a 21" long, steel "L" bracket screwed into brass inserts in the panel and then screwed into the top of the worksurface.

End Panels

The end panels are 1 3/16" thick, particleboard core construction with Grade A Oak or Maple veneer on both faces. The vertical edges of the panel are banded with a 1.5 mm thick solid Oak or Maple external band with a 1/32" radius. On single-face units, the back vertical edge is not edge banded but left unfinished - recommended for use against a wall. For free-standing application, a special cost request is required to finish the back vertical edge. The panels have brass inserts for mounting the worksurface at four different heights (25", 27", 29" and 32" ADA heights). The panel has a 1/8" deep by 1/4" high vein line 4" from the bottom. Overall end panel height is 54" with the glide extended out 1/2".

Shared Panels

The intermediate panels are the same construction as the end panels; however the worksurface and shelf inserts are on both sides of the panel. Shared panels for study and stand-up carrels are machined on both sides.

Back Panels

The back panels are 3/4" thick, 5-ply plywood construction with Grade A Oak or Maple veneer on both faces. The top and bottom edges of the panel are banded with a 1.5 mm thick solid Oak or Maple external band with a 1/32" radius on all edges. The top edge is located 6 1/2" down from the top of the end panels and 4" up from the bottom. Back panels are attached to end panels using cam-lock fasteners. Double-faced units share 1 3/4" thick back panels.

Shelf

The storage shelf is 3/4" thick by 33 1/2" or 45 1/2" wide by 10" deep, plywood core construction. Both faces will be covered with select Oak or Maple veneers and banded on the exposed edge with 1.5 mm solid oak or maple. The study carrel shelf is located 15" above the worksurface. The stand-up carrel shelf is located 26" below the worksurface. Shelf is connected to end panels with shoulder screw and insert in panel and removable connectors in shelf bottom.

Glides

Each end and intermediate panel has a pair of 1 1/8" diameter steel-based adjustable leveling glides with a 1/4" threaded stem.

Circulation Desk

Top

Joints are secured with steel "L" brackets. Desktop is 1/4" thick, particleboard core construction with .05" high-pressure laminate facer and .026" thick backer on the underside.

Cabinet Construction

The front panels are 3/4" thick, 5-ply plywood with Grade A Oak or Maple veneer. All exterior faces are matched for color and grain. The side panels are 1 3/16" thick particleboard with Grade A Oak or Maple veneers and banded on the exposed edge with 1.5 mm solid Oak or Maple. The panel base has a 1/8" deep by 1/4" high vein line at 4" from the bottom. Two stainless steel adjustable glides are at the bottom of each panel.

Adjustable Shelves

Adjustable storage shelves are 3/4" thick, 5-ply plywood construction with select Oak or Maple veneer and banded on exposed edge with solid Oak or Maple. Shelves are adjustable in 1/4" increments and are notched at the ends over metal dowel supports.

Hinged Doors

Doors are 3/4" thick, MDF core construction with Grade A Oak or Maple veneer on both sides. All four edges are banded with solid Oak or Maple edge. Each door is fitted with brushed aluminum or flat black pull and lock.

Storage Drawers

All drawer fronts are 3/4" thick, MDF core construction with select Oak or Maple veneer on both sides. All four edges are banded with solid Oak or Maple edge. Each drawer is fitted with brushed aluminum or flat black pull and lock.

Heights

Depending on the component, various heights are available: 27", 29", 32" and 39" may be specified.



Circulation Desk (cont.)

PowerUp® Module with 3-Prong Plug

Study tables, panel leg tables, study carrels, stand-up height computer carrels and circulation desk modules are available with grommets and PowerUp system.

The PowerUp module is a UL listed, relocatable power tap, which is a surface mounted power module with a plastic cover. When open, one duplex power receptacle and two data jack openings are exposed. The module is 3 1/4" wide by 7" long and 2 1/4" tall when opened and fits securely into a 6 1/4" x 3" cutout, still allowing removal without tools. The module is constructed of polycarbonate with a textured finish, meeting UL 94 V-0 Flame Class minimum requirements. The module has two receptacles, rated at 15 Amps/125 Volts and two locations for data connectors. Snap-in data plates hold data connectors and allow the standard module to accommodate most manufacturers. The data connectors are not supplied with the module and are purchased by the customer. The module has a dampened spring-loaded mechanism to allow the unit to open for use and close when not in use. The power receptacles open above the plane of the tabletop to avoid accidental spills into the receptacle. Data jacks remain stationary to avoid excess wear and tear on the wire connections and promote transmission of data communication. Data ports are molded to accept RJ45 jacks, but can be modified to accept various brands of jacks. The module comes standard with either a 22" or 108" cord and 3-prong plug.

For both grommets and PowerUp modules, the underside of the table is provided with a hinged plastic channel (cord management trough), which covers the bottom of the module. This channel, furnished with metal dividers, is provided for the routing of the power supply cords and data lines.

For starter and adder carrels with grommets or PowerUp modules, round cutouts in the end panels allow wires to pass through from one unit to the other. PowerUp door extrusion and vertical plastic wire manager are standard.

Cords are further managed by the vertical leg wire manager, which comes standard with grommets and the PowerUp system. Leg wireway is scuff-resistant, high-impact rigid PVC plastic, and is fastened to the leg with full-length adhesive bond.

Shelving

End Panel

The end panels are 1 3/16" thick, particleboard core construction with Grade A Oak or Maple veneer on both faces. The front vertical and top edges of the panel are banded with a 1.5 mm thick solid oak or maple external band with a 1/32" radius. On single-face units, the back vertical edge is not edge banded but left unfinished - recommended for use against a wall. For free-standing application, a special cost request is required to finish the back vertical edge. The panel base has a 1/8" deep by 1/4" high vein line 4" from the bottom. Two stainless steel adjustable glides are at the bottom of each panel.

Shared Panel

Same construction as the end panels except brass inserts are on both sides of the panel. Holes for steel pegs are machined on both sides. Adder units are attached with 5/16" through bolts and nuts.

Top Shelf/Cornice Unit

Shelf is 3/4" thick of Oak or Maple construction. The top cornice rail consists of an Oak or Maple 3/4" thick top with 1 3/8" high by 3/4" thick horizontal support, set back 3/16" from the shelf top. Top of the shelf is flush with the sides. Shelf is attached using 1 1/4" x 1 1/4" wood cleats with bolts and metal inserts in the end panels.

Base

Pre-assembled box with a finished outer kick rail enables shelving to be assembled in the vertical position. Bottom shelf is set into place and positioned by using steel pegs.

Shelving (cont.)

Adjustable Wood Shelves

Wood shelves are 3/4" thick solid Oak or Maple construction. The shelf is grooved on the underside to fit over turned and grooved steel pegs, which are inserted into holes in the end panels. Holes are spaced at 1 1/4" space intervals. Peg and groove design prevents accidental removal. The fixed middle shelf is mounted using wood cleats and screws on units 60 1/2" and higher.

Adjustable Metal Shelves

Metal shelves are 18-gauge steel with notches on the underside to rest on turned and grooved steel pegs. Flat shelf is 1" thick and triple bent front and back edges provide superior strength and eliminate sharp edges. Book stop shelf is bent upward to form 90° angle, 1 5/8" high above the shelf surface to function as a book stop. Electrostatically applied powder-coat finish. Metal shelves accept spring-type overhead wire book support. Metal shelf units are shipped with a wood base shelf.

Periodical Shelving

End panels and top and bottom shelf assembly construction are the same as standard shelving. Adjustable shelves include 3/4" solid wood angled bracket supports and an 18-gauge steel shelf pivot bracket. A 3/4" solid wood shelf with a 1/2" x 1 1/2" stop rail is mounted at an angle of approximately 45° so that periodicals can be easily viewed. The shelf pivots and can be flipped up to lay flat for storage access below.

Rolling Book Cart

All end panels and shelves are 3/4" plywood with Oak or Maple veneer laminate and a 1.5 mm solid wood edge banding. Shelves are attached to the end panels using cam lock fasteners and solid wood dowels.

Bottom shelf is reinforced with wood cleats screwed into the shelf and end panels. Casters are two swivel and two stationary. Two cart sizes are available. The 29 7/8" wide by 36 11/64" high by 14 1/2" deep comes with two shelves which have clearance heights of 13" and 11 1/4". The 39 7/8" wide by 43 17/32" high by 14 1/2" deep comes with two shelves which both have clearance heights of 14 5/16".

Rolling Book Cart with Slanted Shelves

All end panels and shelves are 3/4" plywood with Oak or Maple veneer laminate and a 1.5 mm solid wood edge banding. Shelves are attached to the end panels using cam lock fasteners and solid wood dowels. Bottom shelf is reinforced with wood cleats screwed into the shelf and end panels. Casters are two swivel and two stationary. Two cart sizes are available. The 29 7/8" wide by 38 13/16" high by 14 1/2" deep comes with two shelves slanted inward with slanted shelf backs, which have clearance heights of 8 7/8" and 11 7/16". The 39 7/8" wide by 44 51/64" high by 14 1/2" deep with two shelves slanted inward with slanted shelf backs, which have clearance heights of 8 7/8" and 17 7/16".

Descending Platform Book Truck

Book truck sides and bottom are 3/4" thick, particleboard construction with Oak or Maple veneer on both faces. Panels are joined together using cam lock fasteners and solid wood dowels. The exposed panel edges are wood edge banded. The descending platform is particleboard veneer construction with a plastic laminate top surface. Beneath the laminated platform is a depressible mechanism which is guided on rollers and supported by spring compression, so it raises and lowers according to the weight of books on it. Four 2 1/2" diameter heavy-duty swivel casters are secured to the bottom of the book truck.



CrossRoads Chair - 4-Leg

Back Posts

Back posts are made of five 4" stock, steam bent to shape and finished to 1" thickness.

Side Rails

Side rails are made of four 4" stock, finished to $\frac{3}{16}$ " thickness by 2" wide and double doweled to the front and back posts using $\frac{3}{8}$ " x 2" dowels.

Side Stretchers

Side stretchers are made of four 4" stock, finished to $\frac{3}{16}$ " x $\frac{3}{16}$ ". The stretchers are fastened to the front and back posts using $\frac{9}{16}$ " chucks with each joint pinned to further reinforce the joint.

Top Slat

The top slat is made of four 4" stock, finished to $\frac{3}{16}$ " thickness and steam bent to a 24" radius. The top slat is shaped to form and double doweled to the back posts using $\frac{3}{8}$ " x $1\frac{1}{2}$ " dowels.

Bottom Slat

The bottom slat is made of four 4" stock, steam bent to a 24" radius, finished to $\frac{3}{16}$ " thickness by $3\frac{3}{8}$ " wide and double doweled to the back posts using $\frac{3}{8}$ " x $1\frac{1}{2}$ " dowels.

Banisters

Banisters is made of six 4" stock, finished to $\frac{3}{8}$ " thickness by 1" wide, steam bent to shape and mortised into the top and bottom slats.

Front Rail

The front rail is made of four 4" stock, finished to $\frac{3}{16}$ " thickness by 2" wide and double doweled to the front posts using $\frac{3}{8}$ " x 2" dowels.

Cross Stretchers

Cross stretchers are made of four 4" stock, finished to $\frac{3}{16}$ " x $\frac{3}{16}$ " and fastened to the side stretchers using $\frac{9}{16}$ " chucks with each joint pinned to further reinforce the joint.

Wood Seat

Seats are made of five 5/4" stock, surfaced to $\frac{3}{16}$ " thickness prior to being defect ripped on a straight-line rip saw. Individual seat pieces will not exceed $3\frac{1}{2}$ " wide. Seat stock will be mechanically glued to ensure uniform coating of polyvinyl acetate emulsion glue prior to being clamped using a pneumatic torque drive to ensure proper pressure on glue joints. Seat blanks will be double surfaced prior to shaping to form and saddling. Seat is ganged into bottom slat and fastened to each back post by one # 12 x $2\frac{1}{4}$ " tapping screw concealed by a wood button. Two # 12 x 2" tapping screws secure the seat to the front rail and one # 12 x 2" tapping screw to secure the seat to each side rail.

Corner Blocks

Corner blocks further reinforce the frame and are glued and screwed in place. Two # 10 x $1\frac{1}{4}$ " twinfast screws and one # 12 x $2\frac{1}{4}$ " tapping screw secure each block to the frame.

Glue

Polyvinyl alcohol ester blend with polyvinyl acetate is the glue used in the final chair assembly.

Glides

$\frac{7}{8}$ " diameter rubber cushion, chrome-plated glides are standard.

DIMENSIONS

CrossRoad Armless Wood Chair Dimensions (Non-Upholstered)(CRCHR)	
Seat Height	18"
Sitting Depth	15"
Overall Depth	18"
Overall Width	18"
Overall Height	35"
Grade Level Use	4-Adult
Weight	35#

CrossRoad Wood Chair with Arms Dimensions (Non-Upholstered)(CRCHRA)	
Seat Height	18"
Sitting Depth	17 $\frac{1}{2}$ "
Overall Depth	22 $\frac{1}{2}$ "
Overall Width	23 $\frac{1}{2}$ "
Overall Height	35"
Grade Level Use	4-Adult
Weight	45#

CrossRoad Armless Wood Chair Dimensions (Upholstered)(CRCHR U)	
Seat Height	19 $\frac{1}{2}$ "*
Sitting Depth	15"
Overall Depth	18"
Overall Width	18"
Overall Height	35"
Grade Level Use	5-Adult
Weight	37#

CrossRoad Wood Chair with Arms Dimensions (Upholstered)(CRCHRAU)	
Seat Height	19 $\frac{1}{2}$ "
Sitting Depth	17 $\frac{1}{2}$ "
Overall Depth	22 $\frac{1}{2}$ "
Overall Width	23 $\frac{1}{2}$ "
Overall Height	35"
Grade Level Use	4-Adult
Weight	47#

*18" chairs with seat upholstery added, raise the seat to 19 $\frac{1}{2}$ ". This seat height will cause interference when paired with 29" height study tables

*18" chairs with seat upholstery added, raise the seat to 19 $\frac{1}{2}$ ". This seat height will cause interference when paired with 29" height study tables

CrossRoad Study Table Leg Clearance (Apron-to-Floor)			
Study Table Leg Clearance (Apron-to-Floor)	21 $\frac{7}{8}$ "	23 $\frac{7}{8}$ "	26 $\frac{7}{8}$ "

CrossRoad Study Table & Chair Leg Clearance (Apron-to-Seat)			
Table Heights:	27"	29"	32"
14" Wood Chair	7 $\frac{7}{8}$ "	9 $\frac{7}{8}$ "	12 $\frac{7}{8}$ "
15.5" Upholstered Chair	6 $\frac{3}{8}$ "	8 $\frac{3}{8}$ "	11 $\frac{3}{8}$ "
16" Wood Chair	5 $\frac{7}{8}$ "	7 $\frac{7}{8}$ "	10 $\frac{7}{8}$ "
17.5" Upholstered Chair	4 $\frac{3}{8}$ "	6 $\frac{3}{8}$ "	9 $\frac{3}{8}$ "
18" Wood Chair	3 $\frac{7}{8}$ "	5 $\frac{7}{8}$ "	8 $\frac{7}{8}$ "
19.5" Upholstered Chair	2 $\frac{3}{8}$ "	4 $\frac{3}{8}$ "	7 $\frac{3}{8}$ "

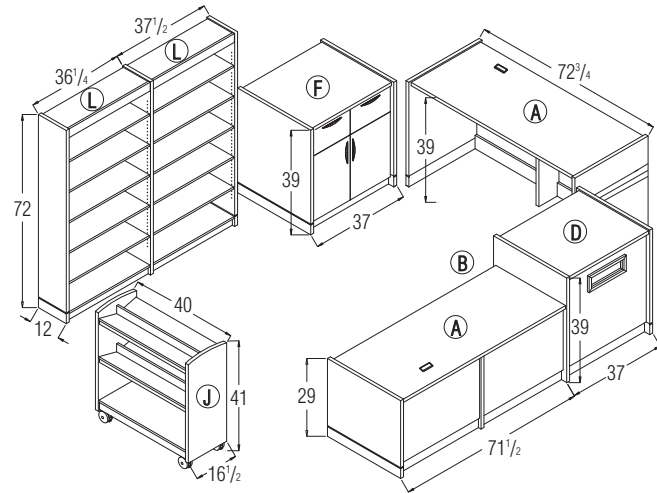

Typical C-Shape Circulation Desk

Work Space: 132 sq. ft.
Oak Budget List Price to be quoted
Maple Budget List Price to be quoted

Circulation Desk Features:

- A. Extended desk modules
- B. Mobile pedestals
- D. Book return module
- E. Descending platform book truck
- F. Cupboard storage unit
- J. Rolling book cart
- L. Shelving units

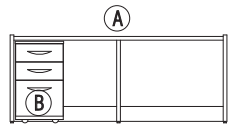

Extended Desk w/Mobile

Inside view

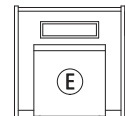

Book Return Unit w/Book

Inside view



Book Return Unit w/Book Truck
Cupboard Storage Unit w/Drawer

Inside view

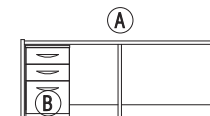

Extended Desk w/Mobile Pedestal

Inside view

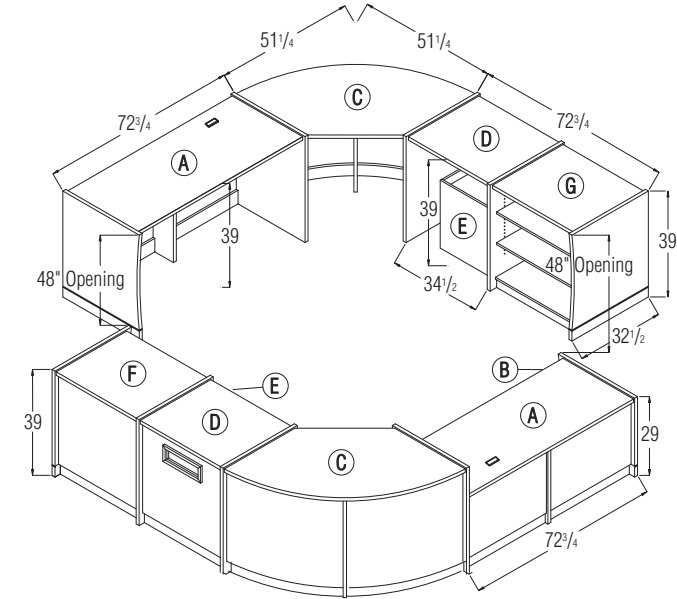

Typical O-Shape Circulation Desk

Work Space: 250 sq. ft.
Oak Budget List Price to be quoted
Maple Budget List Price to be quoted

Circulation Desk Features:

- A. Extended desk modules
- B. Mobile pedestal
- C. Extended corner units
- D. Book return module
- E. Descending platform book trucks
- F. Cupboard storage unit
- G. Open storage unit

Typical U-Shape Circulation Desk

Work Space: 240 sq. ft.
Oak Budget List Price to be quoted
Maple Budget List Price to be quoted

Circulation Desk Features:

- A. Extended desk modules
- B. Mobile pedestals
- C. Extended corner units
- D. Book return modules
- E. Descending platform book trucks
- F. Cupboard storage unit
- G. Open storage unit

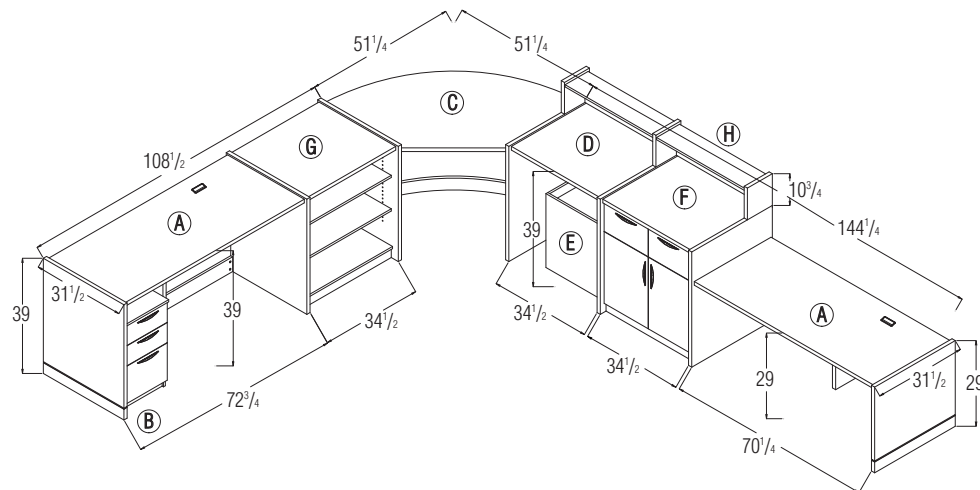

Typical L-Shape Circulation Desk

Work Space: 216 sq. ft.
Oak Budget List Price to be quoted
Maple Budget List Price to be quoted

Circulation Desk Features:

- A. Extended desk modules
- B. Mobile pedestal
- C. Extended corner unit
- D. Book return module
- E. Descending platform book truck
- F. Cupboard storage unit
- G. Open storage unit
- H. Transaction counter

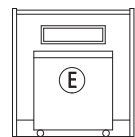

Book Return Module:

Inside view

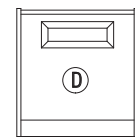

Book Return Module:

Outside view



Cupboard Storage Unit w/Drawer
Book Return Unit w/Book Truck

Inside view

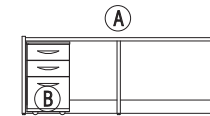

Extended Desk w/Mobile Pedestal

Inside view

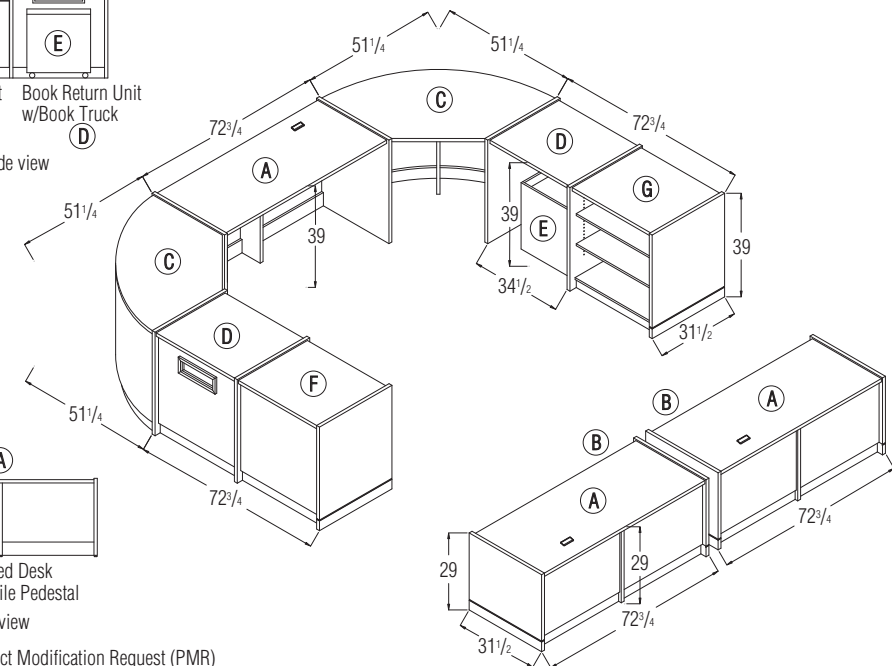

Typical U-Shape Circulation Desk

Work Space: 240 sq. ft.
Oak Budget List Price to be quoted
Maple Budget List Price to be quoted

Circulation Desk Features:

- A. Extended desk modules
- B. Mobile pedestals
- C. Extended corner units
- D. Book return modules
- E. Descending platform book trucks
- F. Cupboard storage unit
- G. Open storage unit

Note: Drawing and Product Modification Request (PMR) are required prior to quote for circulation desks. Contact KI

Note: Drawing and Product Modification Request (PMR) are required prior to quote for circulation desks. Contact KI

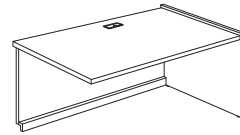

Standard Desk Module

- straight base only
- 1 grommet or 1 PowerUp module
- 29", 32" or 39" height
- 31½"D x 35½"W

Oak w/ grommet budget list price to be quoted
Oak w/ PowerUp budget list price to be quoted

Maple w/ grommet budget list price to be quoted
Maple w/ PowerUp budget list price to be quoted

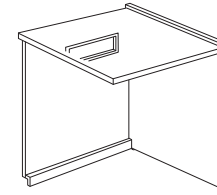

Book Return Module with Slot

- for use with Descending Platform Book Truck
- book slot opening measure 18"W x 4"H
- 39" height
- 31½"D x 35½"W

Oak budget list price to be quoted
Maple budget list price to be quoted

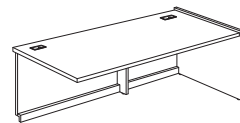

Extended Desk Module

- straight base only
- 2 grommets or 2 PowerUp modules
- knife bracket supports center of unit
- 29", 32" or 39" height
- 31½"D x 71½"W

Oak w/ grommets budget list price to be quoted
Oak w/ PowerUp budget list price to be quoted

Maple w/ grommets budget list price to be quoted
Maple w/ PowerUp budget list price to be quoted

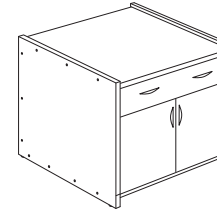

Cupboard Storage Unit with Drawer

- 1 adjustable and 1 fixed shelf
- drilled holes in outer panels for attachment to other modules
- 39" height
- 31½"D x 37"W

Oak budget list price to be quoted
Maple budget list price to be quoted

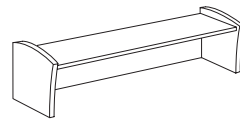

Transaction Counter with End Panels

- veneer with wood banding
- for use with extended desk module
- 10"D x 72½"W x 10½"H

Oak budget list price to be quoted
Maple budget list price to be quoted

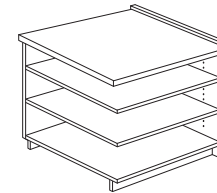

Open Storage Unit

- 2 adjustable and 2 fixed shelf
- 39" height
- 31½"D x 35½"W

Oak budget list price to be quoted
Maple budget list price to be quoted

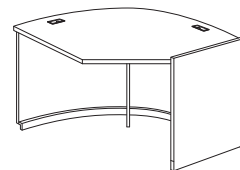

90° Extended Corner Module

- 2-piece unit
- straight base only
- 2 grommets or 2 PowerUp modules
- overall radius 51.21"
- 29" or 39" height
- 36.2"D x 73"W (outer corner to outer corner)

Oak w/ grommet budget list price to be quoted
Oak w/ PowerUp budget list price to be quoted

Maple w/ grommet budget list price to be quoted
Maple w/ PowerUp budget list price to be quoted

**Wood Finish****Oak Wood Finish - Core**

Brighton Walnut on Oak	VBW
Castle Oak on Oak	VOK
Cinnamon on Oak	OCN
Cocoa on Oak	OCA
Florence Walnut on Oak	OFC
Medium on Oak	SMD
River Cherry on Oak	ORY

Ocean	LON
Pinnacle Walnut	LPW
River Cherry	LRY
Shadow Zephyr	LSR
Sterling Ash	LAZ
Titanium Evolv	LTV
White Nebula	LWL
White Sand	LWN
Windsor Mahogany	LWY

Maple Wood Finish - Core

Cherry Storm on Maple	MCX
Cinnamon on Maple	MCN
Cocoa on Maple	MCA
Florence Walnut on Maple	MFC
Kensington Maple on Maple	MMA
Kensington Maple on Maple Legacy	MMAL
Monticello Maple on Maple	MMT
River Cherry on Maple	MRY

Drawer Pulls for Circulation Desk

Aluminum	PAA
Black	PAB

The Stained Finish upcharge does not apply to Kensington Maple or Castle Oak.

Module/Grommet Color

Black grommet(s) or PowerUp	BL
Blue Grey grommet(s) or PowerUp	GR
Sand grommet(s) or PowerUp	SA
Warm Grey grommet(s) or PowerUp	WG

Laminate Color

Beigewood	LBZ
Belair	LBQ
Biltmore Cherry	LBT
Black	LBK
Brighton Walnut	LBW
Castle Oak	LCO
Cherry Storm	LCX
Classic Linen	LCI
Cocobala	LCC
Crisp Linen	LRI
Designer White	LDR
Dove Grey	LDG
Florence Walnut	LFC
Friston Ash	LFH
Frosty White	LFW
Graphite Nebula	LGN
Grey	LGE
High Rise	LHE
Hollyberry	LHY
Island	LID
Italian Silver Ash	LIT
Kensington Maple	LKM
Lapis Blue	LLB
Monticello Maple	LMT
North Sea	LNA

Finish Cards

View color swatches for items listed within this document.

[Paints](#)[Plastics/Poly](#)[Wood/Veneer](#)[Laminates](#)[Molded Edges](#)[Edge Styles](#)[Hard Plastics](#)[Glass](#)

Certain options referenced may not be available on GSA Schedule.



	D x W	MODEL NUMBER									Approx. Packaged Weight	Price		
		Basic Model	Wood Type	Apron Detail	Height	Grommet/Module Type	Grommet/Module Location	Grommet/Module Color	Wood Finish	Surface Finish		Oak	Maple	
	30 x 60"	CRT3060	<input type="checkbox"/>	<input type="checkbox"/> <input type="checkbox"/> <input type="checkbox"/> <input type="checkbox"/>	<input type="checkbox"/>	<input type="checkbox"/>	<input type="checkbox"/> <input type="checkbox"/> <input type="checkbox"/> <input type="checkbox"/>	<input type="checkbox"/>	<input type="checkbox"/> <input type="checkbox"/> <input type="checkbox"/> <input type="checkbox"/>	<input type="checkbox"/>	<input type="checkbox"/> <input type="checkbox"/> <input type="checkbox"/> <input type="checkbox"/>	140.0#	\$ 2429	\$ 2624
	30 x 72"	CRT3072	<input type="checkbox"/>	<input type="checkbox"/> <input type="checkbox"/> <input type="checkbox"/> <input type="checkbox"/>	<input type="checkbox"/>	<input type="checkbox"/>	<input type="checkbox"/> <input type="checkbox"/> <input type="checkbox"/> <input type="checkbox"/>	<input type="checkbox"/>	<input type="checkbox"/> <input type="checkbox"/> <input type="checkbox"/> <input type="checkbox"/>	<input type="checkbox"/>	<input type="checkbox"/> <input type="checkbox"/> <input type="checkbox"/> <input type="checkbox"/>	161.0#	2557	2762
	30 x 84"	CRT3084	<input type="checkbox"/>	<input type="checkbox"/> <input type="checkbox"/> <input type="checkbox"/> <input type="checkbox"/>	<input type="checkbox"/>	<input type="checkbox"/>	<input type="checkbox"/> <input type="checkbox"/> <input type="checkbox"/> <input type="checkbox"/>	<input type="checkbox"/>	<input type="checkbox"/> <input type="checkbox"/> <input type="checkbox"/> <input type="checkbox"/>	<input type="checkbox"/>	<input type="checkbox"/> <input type="checkbox"/> <input type="checkbox"/> <input type="checkbox"/>	174.0#	2849	3374
	30 x 96"	CRT3096	<input type="checkbox"/>	<input type="checkbox"/> <input type="checkbox"/> <input type="checkbox"/> <input type="checkbox"/>	<input type="checkbox"/>	<input type="checkbox"/>	<input type="checkbox"/> <input type="checkbox"/> <input type="checkbox"/> <input type="checkbox"/>	<input type="checkbox"/>	<input type="checkbox"/> <input type="checkbox"/> <input type="checkbox"/> <input type="checkbox"/>	<input type="checkbox"/>	<input type="checkbox"/> <input type="checkbox"/> <input type="checkbox"/> <input type="checkbox"/>	187.0#	3881	4188
	36 x 60"	CRT3660	<input type="checkbox"/>	<input type="checkbox"/> <input type="checkbox"/> <input type="checkbox"/> <input type="checkbox"/>	<input type="checkbox"/>	<input type="checkbox"/>	<input type="checkbox"/> <input type="checkbox"/> <input type="checkbox"/> <input type="checkbox"/>	<input type="checkbox"/>	<input type="checkbox"/> <input type="checkbox"/> <input type="checkbox"/> <input type="checkbox"/>	<input type="checkbox"/>	<input type="checkbox"/> <input type="checkbox"/> <input type="checkbox"/> <input type="checkbox"/>	145.0#	3013	3259
	36 x 72"	CRT3672	<input type="checkbox"/>	<input type="checkbox"/> <input type="checkbox"/> <input type="checkbox"/> <input type="checkbox"/>	<input type="checkbox"/>	<input type="checkbox"/>	<input type="checkbox"/> <input type="checkbox"/> <input type="checkbox"/> <input type="checkbox"/>	<input type="checkbox"/>	<input type="checkbox"/> <input type="checkbox"/> <input type="checkbox"/> <input type="checkbox"/>	<input type="checkbox"/>	<input type="checkbox"/> <input type="checkbox"/> <input type="checkbox"/> <input type="checkbox"/>	166.0#	3136	3502
	36 x 84"	CRT3684	<input type="checkbox"/>	<input type="checkbox"/> <input type="checkbox"/> <input type="checkbox"/> <input type="checkbox"/>	<input type="checkbox"/>	<input type="checkbox"/>	<input type="checkbox"/> <input type="checkbox"/> <input type="checkbox"/> <input type="checkbox"/>	<input type="checkbox"/>	<input type="checkbox"/> <input type="checkbox"/> <input type="checkbox"/> <input type="checkbox"/>	<input type="checkbox"/>	<input type="checkbox"/> <input type="checkbox"/> <input type="checkbox"/> <input type="checkbox"/>	179.0#	3609	3934
	36 x 96"	CRT3696	<input type="checkbox"/>	<input type="checkbox"/> <input type="checkbox"/> <input type="checkbox"/> <input type="checkbox"/>	<input type="checkbox"/>	<input type="checkbox"/>	<input type="checkbox"/> <input type="checkbox"/> <input type="checkbox"/> <input type="checkbox"/>	<input type="checkbox"/>	<input type="checkbox"/> <input type="checkbox"/> <input type="checkbox"/> <input type="checkbox"/>	<input type="checkbox"/>	<input type="checkbox"/> <input type="checkbox"/> <input type="checkbox"/> <input type="checkbox"/>	192.0#	4288	4674
	42 x 60"	CRT4260	<input type="checkbox"/>	<input type="checkbox"/> <input type="checkbox"/> <input type="checkbox"/> <input type="checkbox"/>	<input type="checkbox"/>	<input type="checkbox"/>	<input type="checkbox"/> <input type="checkbox"/> <input type="checkbox"/> <input type="checkbox"/>	<input type="checkbox"/>	<input type="checkbox"/> <input type="checkbox"/> <input type="checkbox"/> <input type="checkbox"/>	<input type="checkbox"/>	<input type="checkbox"/> <input type="checkbox"/> <input type="checkbox"/> <input type="checkbox"/>	154.0#	3201	3474
	42 x 72"	CRT4272	<input type="checkbox"/>	<input type="checkbox"/> <input type="checkbox"/> <input type="checkbox"/> <input type="checkbox"/>	<input type="checkbox"/>	<input type="checkbox"/>	<input type="checkbox"/> <input type="checkbox"/> <input type="checkbox"/> <input type="checkbox"/>	<input type="checkbox"/>	<input type="checkbox"/> <input type="checkbox"/> <input type="checkbox"/> <input type="checkbox"/>	<input type="checkbox"/>	<input type="checkbox"/> <input type="checkbox"/> <input type="checkbox"/> <input type="checkbox"/>	171.0#	3350	3682
	42 x 84"	CRT4284	<input type="checkbox"/>	<input type="checkbox"/> <input type="checkbox"/> <input type="checkbox"/> <input type="checkbox"/>	<input type="checkbox"/>	<input type="checkbox"/>	<input type="checkbox"/> <input type="checkbox"/> <input type="checkbox"/> <input type="checkbox"/>	<input type="checkbox"/>	<input type="checkbox"/> <input type="checkbox"/> <input type="checkbox"/> <input type="checkbox"/>	<input type="checkbox"/>	<input type="checkbox"/> <input type="checkbox"/> <input type="checkbox"/> <input type="checkbox"/>	185.0#	3835	4160
	42 x 96"	CRT4296	<input type="checkbox"/>	<input type="checkbox"/> <input type="checkbox"/> <input type="checkbox"/> <input type="checkbox"/>	<input type="checkbox"/>	<input type="checkbox"/>	<input type="checkbox"/> <input type="checkbox"/> <input type="checkbox"/> <input type="checkbox"/>	<input type="checkbox"/>	<input type="checkbox"/> <input type="checkbox"/> <input type="checkbox"/> <input type="checkbox"/>	<input type="checkbox"/>	<input type="checkbox"/> <input type="checkbox"/> <input type="checkbox"/> <input type="checkbox"/>	198.0#	4516	4899

- CRT
Rectangular Table
- Choice of 2,3, (or without) grommets or PowerUp® modules
 - Straight apron

A B C D E F G H I

HOW TO ORDER

- Indicate the following information on order form:
1. Quantity of each item.
 2. Model number, including options. See "How To Build a Model Number".
 3. Any special service required.

Note:

- The indicates that a choice is required.
- The absence of the indicates that no choice is required.
- Alpha-numeric characters in place of indicate that no other alternatives are available.

HOW TO BUILD A MODEL NUMBER

- A** Select basic model.
- B** Select wood type.
 - O** - Oak
 - M** - Maple
- C** Select apron detail.
 - PSTR** - Straight apron
- D** Select height.
 - 27** - Junior height - 27"
 - 29** - Adult height - 29"
 - 32** - ADA wheelchair height - 32"
- E** Select grommet or PowerUp.
 - 60" & 72" wide tables are available with 2 grommets or 2 PowerUp modules or none.
 - 84" & 96" wide tables are available with 3 grommets or 3 PowerUp modules or none.
 - 2G** - 2 grommets; add \$136
 - 2P** - 2 PowerUp modules; add \$330
 - 3G** - 3 grommets; add \$205
 - 3P** - 3 PowerUp modules; add \$493

- NG** - No Grommets/PowerUp
- F** Select grommet or PowerUp location.
 - CTRG** - Center grommet/module location
 - EDGG** - Edge grommet/module location
 - If no grommet or PowerUp module were selected, then skip "location" selection.
- G** Select grommet/module color. Refer to the **Product Color Options** page in this price list.
- H** Select wood finish (for table edge & legs). Refer to the **Product Color Options** page in this price list. Stained finish colors \$44.
- I** Select surface finish. Refer to the **Product Color Options** page in this price list. Additional plastic laminate surfaces are available but may require an upcharge and additional leadtime. Please contact KI.

FINISH INFORMATION

Color Match
KI offers the additional option of color matching paint, polypropylene, or wood stain through Product Modification Requests, contact Customer Service for details.



OPTIONS

- Electrical Ganging**
Contact KI for electrical ganging of multiple tables.
- Wood Leg Wireway**
If grommets or PowerUp® modules are ordered, a routed wood leg wireway may be ordered in place of the standard wireway. Add /RL to the end of model number for routed wood leg wireway option and add \$190 to list.

SPECIAL SERVICES

- Special Carton Marking**
With specially marked information N/C
 - Shipping**
Ships **knocked down, FOB Factory of origin, freight prepaid.** Freight class 85.
- Specifications and prices are subject to change without prior notice.

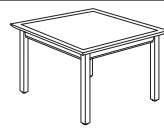
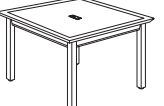

MODEL	D x W	MODEL NUMBER								Approx. Packaged Weight	Oak	Maple	
		Basic Model	Wood Type	Apron Detail	Height	Grommet/Module Type	Grommet/Module Color	Wood Finish	Surface Finish				
 Straight Apron, No Grommets	42 x 42"	CRT4242	<input type="checkbox"/>	<input type="checkbox"/> <input type="checkbox"/> <input type="checkbox"/> <input type="checkbox"/>	<input type="checkbox"/> <input type="checkbox"/>	<input type="checkbox"/> <input type="checkbox"/>	<input type="checkbox"/> <input type="checkbox"/>	<input type="checkbox"/> <input type="checkbox"/>	<input type="checkbox"/> <input type="checkbox"/>	<input type="checkbox"/> <input type="checkbox"/>	125.0#	\$ 2177	\$ 2468
	48 x 48"	CRT4848	<input type="checkbox"/>	<input type="checkbox"/> <input type="checkbox"/> <input type="checkbox"/> <input type="checkbox"/>	<input type="checkbox"/> <input type="checkbox"/>	<input type="checkbox"/> <input type="checkbox"/>	<input type="checkbox"/> <input type="checkbox"/>	<input type="checkbox"/> <input type="checkbox"/>	<input type="checkbox"/> <input type="checkbox"/>	<input type="checkbox"/> <input type="checkbox"/>	<input type="checkbox"/> <input type="checkbox"/>	130.0#	2560
 Straight Apron, 1 Grommet													
CRT													
 Straight Apron, No Grommets	44"	CRT42R	<input type="checkbox"/>	<input type="checkbox"/> <input type="checkbox"/> <input type="checkbox"/> <input type="checkbox"/>	<input type="checkbox"/> <input type="checkbox"/>	<input type="checkbox"/> <input type="checkbox"/>	<input type="checkbox"/> <input type="checkbox"/>	<input type="checkbox"/> <input type="checkbox"/>	<input type="checkbox"/> <input type="checkbox"/>	<input type="checkbox"/> <input type="checkbox"/>	140.0#	\$ 2574	\$ 3144
	50"	CRT48R	<input type="checkbox"/>	<input type="checkbox"/> <input type="checkbox"/> <input type="checkbox"/> <input type="checkbox"/>	<input type="checkbox"/> <input type="checkbox"/>	<input type="checkbox"/> <input type="checkbox"/>	<input type="checkbox"/> <input type="checkbox"/>	<input type="checkbox"/> <input type="checkbox"/>	<input type="checkbox"/> <input type="checkbox"/>	<input type="checkbox"/> <input type="checkbox"/>	145.0#	3095	3468
 Straight Apron, 1 Grommet													
CRT													

A **B** **C** **D** **E** **F** **G** **H**

HOW TO ORDER

- Indicate the following information on order form:
- Quantity of each item.
 - Model number, including options. See "How To Build a Model Number".
 - Any special service required.

Note:

- The indicates that a choice is required.
- The absence of the indicates that no choice is required.
- Alpha-numeric characters in place of indicate that no other alternatives are available.

HOW TO BUILD A MODEL NUMBER

- A** Select basic model.
- B** Select wood type.
 - O** - Oak
 - M** - Maple
- C** Select apron detail.
 - PSTR** - Straight apron
- D** Select height.
 - 27** - Junior height - 27"
 - 29** - Adult height - 29"
 - 32** - ADA wheelchair height - 32"
- E** Select grommet or PowerUp.
 - 1G** - 1 grommet; add \$69
 - 1P** - 1 PowerUp module; add \$164
 - NG** - No Grommets/PowerUp

- G** Select wood finish (for table edge & legs). Refer to the **Product Color Options** page in this price list. Stained finish colors; add \$44.
- H** Select surface finish. Refer to the **Product Color Options** page in this price list. Additional plastic laminate surfaces are available but may require an upcharge and additional leadtime. Please contact KI.

FINISH INFORMATION

Color Match
 KI offers the additional option of color matching paint, polypropylene, or wood stain through Product Modification Requests, contact Customer Service for details.

OPTIONS

Electrical Ganging
 Contact KI for electrical ganging of multiple tables.

Wood Leg Wireway
 If grommets or PowerUp® modules are ordered, a routed wood leg wireway may be ordered in place of the standard wireway. Add /RL to the end of model number for routed wood leg wireway option and add \$190 to list.

SPECIAL SERVICES

Special Carton Marking
 With specially marked information N/C

Shipping
 Ships **knocked down, FOB Factory of origin, freight prepaid.** Freight class 85.

Specifications and prices are subject to change without prior notice.

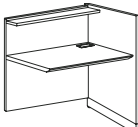

	D x W	MODEL NUMBER										Approx. Packaged Weight		
		Basic Model	Wood Type	Panel	Base	Height	Task Light	Grommet/Module Type	Grommet/Module Color	Wood Finish	Surface Finish	Oak	Maple	
	30 x 36"	CRCS3036S	<input type="checkbox"/>	<input type="checkbox"/>	<input type="checkbox"/>	<input type="checkbox"/>	<input type="checkbox"/>	<input type="checkbox"/>	<input type="checkbox"/>	<input type="checkbox"/>	<input type="checkbox"/>	201.0#	\$ 4379	\$ 6405
	30 x 48"	CRCS3048S	<input type="checkbox"/>	<input type="checkbox"/>	<input type="checkbox"/>	<input type="checkbox"/>	<input type="checkbox"/>	<input type="checkbox"/>	<input type="checkbox"/>	<input type="checkbox"/>	<input type="checkbox"/>	231.0#	5020	7352
<p>CRC Study Carrel Starter Unit-Single Face</p> <ul style="list-style-type: none"> • Straight panel or base • Choice of 1 grommet or 1 PowerUp® module • Standard placement of grommet is in right rear corner of worksurface • Note: Provide a plan layout indicating grommet location on the worksurface, if other than standard • With or without task light • Adjustable or wheelchair-height adjustable 														
	30 x 34-3/4"	CRCS3036A	<input type="checkbox"/>	<input type="checkbox"/>	<input type="checkbox"/>	<input type="checkbox"/>	<input type="checkbox"/>	<input type="checkbox"/>	<input type="checkbox"/>	<input type="checkbox"/>	<input type="checkbox"/>	146.0#	\$ 3292	\$ 4621
	30 x 46-1/2"	CRCS3048A	<input type="checkbox"/>	<input type="checkbox"/>	<input type="checkbox"/>	<input type="checkbox"/>	<input type="checkbox"/>	<input type="checkbox"/>	<input type="checkbox"/>	<input type="checkbox"/>	<input type="checkbox"/>	176.0#	3932	5570
<p>CRC Study Carrel Adder Unit-Single Face</p> <ul style="list-style-type: none"> • Straight panel or base • Choice of 1 grommet or 1 PowerUp® module • Standard placement of grommet is in right rear corner of worksurface • Note: Provide a plan layout indicating grommet location on the worksurface, if other than standard • With or without task light • Adjustable or wheelchair-height adjustable 														
<p>A B C D E F G H I J</p>														

HOW TO ORDER

- Indicate the following information on order form:
1. Quantity of each item.
 2. Model number, including options. See "How To Build a Model Number".
 3. Any special service required.

Note:

- The indicates that a choice is required.
- The absence of the indicates that no choice is required.
- Alpha-numeric characters in place of indicate that no other alternatives are available.

HOW TO BUILD A MODEL NUMBER

- A** Select basic model.
- B** Select wood type.
 - Oak
 - Maple
- C** Select panel.
PSTR - Straight panel
- D** Select base.
BSTR - Straight base
- E** Select height (worksurface).
AH - Adjustable height
AH32 - Adjustable wheelchair height
- F** Select task light
1TL - 1 task light; add \$219
NL - No task light
- G** Select grommet or PowerUp.
1G - 1 grommet-standard
1P - 1 PowerUp module; add \$164

- H** Select grommet or PowerUp module color. Refer to the **Product Color Options** page in this price list.
- I** Select wood finish (for table edge & base). Refer to the **Product Color Options** page in this price list. Stained finish colors\$70.
- J** Select surface finish. Refer to the **Product Color Options** page in this price list. Additional plastic laminate surfaces are available but may require an upcharge and additional leadtime. Please contact KI.

FINISH INFORMATION

Color Match
 KI offers the additional option of color matching paint, polypropylene, or wood stain through Product Modification Requests, contact Customer Service for details.

SPECIAL SERVICES

Special Carton Marking

With specially marked information N/C

Shipping
 Ships **knocked down, FOB Factory of origin, freight prepaid.** Freight class 100.

Specifications and prices are subject to change without prior notice.

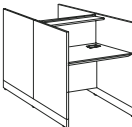
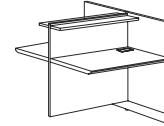

	D x W	MODEL NUMBER										Approx. Packaged Weight			
		Basic Model	Wood Type	Panel	Base	Height	Task Light	Grommet/Module Type	Grommet/Module Color	Wood Finish	Surface Finish	Oak	Maple		
 <p>CRC Study Carrel Starter Unit-Double Face</p> <ul style="list-style-type: none"> • Straight panel or base • Choice of 2 grommets or 2 PowerUp® modules (1 per worksurface) • Standard placement of grommet is in right rear corner of worksurface • Note: Provide a plan layout indicating grommet location on the worksurface, if other than standard • With or without task light • Adjustable or wheelchair-height adjustable 	60 x 36"	CRCD6036S	<input type="checkbox"/>	□□□□	□□□□	□□□□	□□□□	□□	□□	□□□□	□□□□	415.0#	\$ 6943	\$ 9019	
	60 x 48"	CRCD6048S	<input type="checkbox"/>	□□□□	□□□□	□□□□	□□□□	□□	□□	□□□□	□□□□	415.0#	7825	9334	
 <p>CRC Study Carrel Adder Unit-Double Face</p> <ul style="list-style-type: none"> • Straight panel or base • Choice of 2 grommets or 2 PowerUp® modules (1 per worksurface) • Standard placement of grommet is in right rear corner of worksurface • Note: Provide a plan layout indicating grommet location on the worksurface, if other than standard • With or without task light • Adjustable or wheelchair-height adjustable 	60 x 34-3/4"	CRCD6036A	<input type="checkbox"/>	□□□□	□□□□	□□□□	□□□□	□□	□□	□□□□	□□□□	242.0#	\$ 5023	\$ 6793	
	60 x 46-3/4"	CRCD6048A	<input type="checkbox"/>	□□□□	□□□□	□□□□	□□□□	□□□□	□□	□□	□□□□	□□□□	305.0#	5906	8013
				A	B	C	D	E	F	G	H	I	J		

HOW TO ORDER

- Indicate the following information on order form:
- Quantity of each item.
 - Model number, including options. See "How To Build a Model Number".
 - Any special service required.

Note:

- The indicates that a choice is required.
- The absence of the indicates that no choice is required.
- Alpha-numeric characters in place of indicate that no other alternatives are available.

HOW TO BUILD A MODEL NUMBER

- A** Select basic model.
- B** Select wood type.
 - O** - Oak
 - M** - Maple
- C** Select panel.
 - PSTR** - Straight panel
- D** Select base.
 - BSTR** - Straight base
- E** Select height (worksurface).
 - AH** - Adjustable height
 - AH32** - Adjustable wheelchair height
- F** Select task light
 - 2TL** - 2 task lights (1 per worksurface); add \$445
 - NL** - No task light
- G** Select grommet or PowerUp.
 - 2G** - 2 grommets (one per worksurface-standard)
 - 2P** - 2 PowerUp modules (one per worksurface); add \$330

- H** Select grommet or PowerUp module color. Refer to the **Product Color Options** page in this price list.
- I** Select wood finish (for table edge & base). Refer to the **Product Color Options** page in this price list. Stained finish colors; add \$70.
- J** Select surface finish. Refer to the **Product Color Options** page in this price list. Additional plastic laminate surfaces are available but may require an upcharge and additional leadtime. Please contact KI.

FINISH INFORMATION

Color Match
KI offers the additional option of color matching paint, polypropylene, or wood stain through Product Modification Requests, contact Customer Service for details.

SPECIAL SERVICES

Special Carton Marking
With specially marked information N/C

Shipping
Ships **knocked down, FOB Factory of origin, freight prepaid.** Freight class 100.

Specifications and prices are subject to change without prior notice.

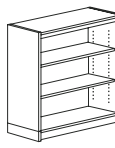
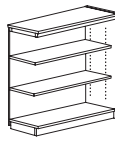
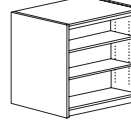
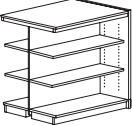

MODEL	D x W	MODEL NUMBER					Approx. Packaged Weight	Approx. Price	
		Basic Model	Wood Type	End Panel	Back Panel	Wood Finish		Oak	Maple
 Shelving Starter Unit-Single Face • Straight base only • 2 straight end panels (1 left and 1 right) • With or without back panel • 2 adjustable and 1 base shelf • Recommended for use against wall only • Anchors recommended • Non-finished backside	10 x 37-1/2"	CRFS4210S	<input type="checkbox"/>	<input type="checkbox"/> <input type="checkbox"/> <input type="checkbox"/> <input type="checkbox"/>	<input type="checkbox"/>	<input type="checkbox"/> <input type="checkbox"/>	50.0#	\$ 1379	\$ 1462
	12 x 37-1/2"	CRFS4212S	<input type="checkbox"/>	<input type="checkbox"/> <input type="checkbox"/> <input type="checkbox"/> <input type="checkbox"/>	<input type="checkbox"/>	<input type="checkbox"/> <input type="checkbox"/>	57.0#	1434	1510
	16 x 37-1/2"	CRFS4216S	<input type="checkbox"/>	<input type="checkbox"/> <input type="checkbox"/> <input type="checkbox"/> <input type="checkbox"/>	<input type="checkbox"/>	<input type="checkbox"/> <input type="checkbox"/>	79.0#	2125	2261
 Shelving Adder Unit-Single Face • 1 straight adder (shared) panel only • With or without back panel • 2 adjustable and 1 base shelf • Recommended for use against wall only • Anchors recommended • Non-finished backside	10 x 36-1/4"	CRFS4210A	<input type="checkbox"/>	PSTR	<input type="checkbox"/>	<input type="checkbox"/> <input type="checkbox"/>	42.0#	\$ 1090	\$ 1152
	12 x 36-1/4"	CRFS4212A	<input type="checkbox"/>	PSTR	<input type="checkbox"/>	<input type="checkbox"/> <input type="checkbox"/>	47.0#	1156	1221
	16 x 36-1/4"	CRFS4216A	<input type="checkbox"/>	PSTR	<input type="checkbox"/>	<input type="checkbox"/> <input type="checkbox"/>	65.0#	1719	1801
 Shelving Starter Unit-Double Face • Straight base only • 2 straight end panels (1 left and 1 right) • With or without back panel • 4 adjustable and 2 base shelves	20 x 37-1/2"	CRFD4220S	<input type="checkbox"/>	<input type="checkbox"/> <input type="checkbox"/> <input type="checkbox"/> <input type="checkbox"/>	<input type="checkbox"/>	<input type="checkbox"/> <input type="checkbox"/>	96.0#	\$ 2165	\$ 2304
	24 x 37-1/2"	CRFD4224S	<input type="checkbox"/>	<input type="checkbox"/> <input type="checkbox"/> <input type="checkbox"/> <input type="checkbox"/>	<input type="checkbox"/>	<input type="checkbox"/> <input type="checkbox"/>	117.0#	2292	2443
 Shelving Adder Unit-Double Face • 1 straight adder (shared) panel only • With or without back panel • 4 adjustable and 2 base shelves	20 x 36-1/4"	CRFD4220A	<input type="checkbox"/>	PSTR	<input type="checkbox"/>	<input type="checkbox"/> <input type="checkbox"/>	80.0#	\$ 1815	\$ 1929
	24 x 36-1/4"	CRFD4224A	<input type="checkbox"/>	PSTR	<input type="checkbox"/>	<input type="checkbox"/> <input type="checkbox"/>	95.0#	1905	2023

A **B** **C** **D** **E**

HOW TO ORDER

- Indicate the following information on order form:
- Quantity of each item.
 - Model number, including options. See "How To Build a Model Number".
 - Any special service required.

Note:

- The indicates that a choice is required.
- The absence of the indicates that no choice is required.
- Alpha-numeric characters in place of indicate that no other alternatives are available.

HOW TO BUILD A MODEL NUMBER

- A** Select basic model.
- B** Select wood type.

O	- Oak
M	- Maple
- C** Select end panel.

PSTR	- Straight panel
-------------	------------------
- D** Select back panel.

BP	- Back panel; add \$186
NP	- No back panel
- E** Select wood finish.
Refer to the **Product Color Options** page in this price list.
Stained finish colors; add \$83.

INFORMATION

Back Panel Weights
When ordering shelving with back panels add the following weights:
 42" high add 15#
 54" high add 18#
 60" high add 20#
 72" high add 24#
 82" high add 27#
 96" high add 35#

FINISH INFORMATION

Color Match
KI offers the additional option of color matching paint, polypropylene, or wood stain through Product Modification Requests, contact Customer Service for details.



SPECIAL SERVICES

Special Carton Marking
With specially marked information N/C

Shipping
Ships **knocked down, FOB Factory of origin, freight prepaid.** Freight class 125.

Specifications and prices are subject to change without prior notice.

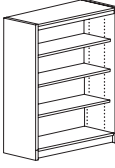
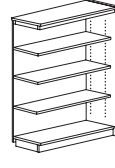

MODEL	D x W	MODEL NUMBER					Approx. Packaged Weight	Finish	
		Basic Model	Wood Type	End Panel	Back Panel	Wood Finish		Oak	Maple
 <p>Shelving Starter Unit-Single Face • Straight base only • 2 straight end panels (1 left and 1 right) • With or without back panel • 2 adjustable, 1 fixed and 1 base shelf • Recommended for use against wall only • Anchors recommended • Non-finished backside</p>	10 x 37-1/2"	CRFS5410S	<input type="checkbox"/>	<input type="checkbox"/> <input type="checkbox"/> <input type="checkbox"/> <input type="checkbox"/>	<input type="checkbox"/>	<input type="checkbox"/> <input type="checkbox"/>	58.0#	\$ 1584	\$ 1683
	12 x 37-1/2"	CRFS5412S	<input type="checkbox"/>	<input type="checkbox"/> <input type="checkbox"/> <input type="checkbox"/> <input type="checkbox"/>	<input type="checkbox"/>	<input type="checkbox"/> <input type="checkbox"/>	69.0#	1668	1768
	16 x 37-1/2"	CRFS5416S	<input type="checkbox"/>	<input type="checkbox"/> <input type="checkbox"/> <input type="checkbox"/> <input type="checkbox"/>	<input type="checkbox"/>	<input type="checkbox"/> <input type="checkbox"/>	91.0#	2414	2665
CRF									
 <p>Shelving Adder Unit-Single Face • 1 straight adder (shared) panel only • With or without back panel • 2 adjustable, 1 fixed and 1 base shelf • Recommended for use against wall only • Anchors recommended • Non-finished backside</p>	10 x 36-1/4"	CRFS5410A	<input type="checkbox"/>	PSTR	<input type="checkbox"/>	<input type="checkbox"/> <input type="checkbox"/>	48.0#	\$ 1257	\$ 1336
	12 x 36-1/4"	CRFS5412A	<input type="checkbox"/>	PSTR	<input type="checkbox"/>	<input type="checkbox"/> <input type="checkbox"/>	55.0#	1337	1417
	16 x 36-1/4"	CRFS5416A	<input type="checkbox"/>	PSTR	<input type="checkbox"/>	<input type="checkbox"/> <input type="checkbox"/>	75.0#	1864	2100
CRF									
 <p>Shelving Starter Unit-Double Face • Straight base only • 2 straight end panels (1 left and 1 right) • With or without back panel • 4 adjustable, 2 fixed and 2 base shelves</p>	20 x 37-1/2"	CRFD5420S	<input type="checkbox"/>	<input type="checkbox"/> <input type="checkbox"/> <input type="checkbox"/> <input type="checkbox"/>	<input type="checkbox"/>	<input type="checkbox"/> <input type="checkbox"/>	114.0#	\$ 2555	\$ 2726
	24 x 37-1/2"	CRFD5424S	<input type="checkbox"/>	<input type="checkbox"/> <input type="checkbox"/> <input type="checkbox"/> <input type="checkbox"/>	<input type="checkbox"/>	<input type="checkbox"/> <input type="checkbox"/>	135.0#	2741	2924
CRF									
 <p>Shelving Adder Unit-Double Face • 1 straight adder (shared) panel only • With or without back panel • 4 adjustable, 2 fixed and 2 base shelves</p>	20 x 36-1/4"	CRFD5420A	<input type="checkbox"/>	PSTR	<input type="checkbox"/>	<input type="checkbox"/> <input type="checkbox"/>	93.0#	\$ 2140	\$ 2280
	24 x 36-1/4"	CRFD5424A	<input type="checkbox"/>	PSTR	<input type="checkbox"/>	<input type="checkbox"/> <input type="checkbox"/>	107.0#	2259	2411
CRF									

A **B** **C** **D** **E**

HOW TO ORDER

- Indicate the following information on order form:
- Quantity of each item.
 - Model number, including options. See "How To Build a Model Number".
 - Any special service required.

Note:

- The indicates that a choice is required.
- The absence of the indicates that no choice is required.
- Alpha-numeric characters in place of indicate that no other alternatives are available.

HOW TO BUILD A MODEL NUMBER

- A** Select basic model.
- B** Select wood type.

O	- Oak
M	- Maple
- C** Select end panel.

PSTR	- Straight panel
-------------	------------------
- D** Select back panel.

BP	- Back panel; add \$211
NP	- No back panel
- E** Select wood finish. Refer to the **Product Color Options** page in this price list. Stained finish colors; add \$83.

INFORMATION

Back Panel Weights
 When ordering shelving with back panels add the following weights:
 42" high add 15#
 54" high add 18#
 60" high add 20#
 72" high add 24#
 82" high add 27#
 96" high add 35#

FINISH INFORMATION

Color Match
 KI offers the additional option of color matching paint, polypropylene, or wood stain through Product Modification Requests, contact Customer Service for details.



SPECIAL SERVICES

Special Carton Marking
 With specially marked information N/C

Shipping
 Ships **knocked down, FOB Factory of origin, freight prepaid.** Freight class 125.

Specifications and prices are subject to change without prior notice.

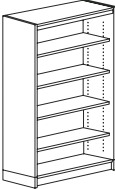

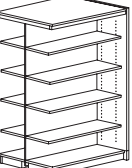
MODEL	D x W	MODEL NUMBER					Approx. Packaged Weight	Finish	
		Basic Model	Wood Type	End Panel	Back Panel	Wood Finish		Oak	Maple
 <p>Shelving Starter Unit-Single Face</p> <ul style="list-style-type: none"> • Straight base only • 2 straight end panels (1 left and 1 right) • With or without back panel • 3 adjustable, 1 fixed and 1 base shelf • Recommended for use against wall only • Anchors recommended • Non-finished backside 	10 x 37-1/2"	CRFS6010S	<input type="checkbox"/>	<input type="checkbox"/> <input type="checkbox"/> <input type="checkbox"/> <input type="checkbox"/>	<input type="checkbox"/>	<input type="checkbox"/> <input type="checkbox"/>	67.0#	\$ 1654	\$ 1756
	12 x 37-1/2"	CRFS6012S	<input type="checkbox"/>	<input type="checkbox"/> <input type="checkbox"/> <input type="checkbox"/> <input type="checkbox"/>	<input type="checkbox"/>	<input type="checkbox"/> <input type="checkbox"/>	81.0#	1754	1857
	16 x 37-1/2"	CRFS6016S	<input type="checkbox"/>	<input type="checkbox"/> <input type="checkbox"/> <input type="checkbox"/> <input type="checkbox"/>	<input type="checkbox"/>	<input type="checkbox"/> <input type="checkbox"/>	103.0#	2569	2869
CRF									
 <p>Shelving Adder Unit-Single Face</p> <ul style="list-style-type: none"> • 1 straight adder (shared) panel only • With or without back panel • 3 adjustable, 1 fixed and 1 base shelf • Recommended for use against wall only • Anchors recommended • Non-finished backside 	10 x 36-1/4"	CRFS6010A	<input type="checkbox"/>	PSTR	<input type="checkbox"/>	<input type="checkbox"/> <input type="checkbox"/>	55.0#	\$ 1313	\$ 1394
	12 x 36-1/4"	CRFS6012A	<input type="checkbox"/>	PSTR	<input type="checkbox"/>	<input type="checkbox"/> <input type="checkbox"/>	63.0#	1396	1487
	16 x 36-1/4"	CRFS6016A	<input type="checkbox"/>	PSTR	<input type="checkbox"/>	<input type="checkbox"/> <input type="checkbox"/>	85.0#	1993	2311
CRF									
 <p>Shelving Starter Unit-Double Face</p> <ul style="list-style-type: none"> • Straight base only • 2 straight end panels (1 left and 1 right) • With or without back panel • 6 adjustable, 2 fixed and 2 base shelves 	20 x 37-1/2"	CRFD6020S	<input type="checkbox"/>	<input type="checkbox"/> <input type="checkbox"/> <input type="checkbox"/> <input type="checkbox"/>	<input type="checkbox"/>	<input type="checkbox"/> <input type="checkbox"/>	133.0#	\$ 2684	\$ 2867
	24 x 37-1/2"	CRFD6024S	<input type="checkbox"/>	<input type="checkbox"/> <input type="checkbox"/> <input type="checkbox"/> <input type="checkbox"/>	<input type="checkbox"/>	<input type="checkbox"/> <input type="checkbox"/>	154.0#	2886	3085
CRF									
 <p>Shelving Adder Unit-Double Face</p> <ul style="list-style-type: none"> • 1 straight adder (shared) panel only • With or without back panel • 6 adjustable, 2 fixed and 2 base shelves 	20 x 36-1/4"	CRFD6020A	<input type="checkbox"/>	PSTR	<input type="checkbox"/>	<input type="checkbox"/> <input type="checkbox"/>	106.0#	\$ 2247	\$ 2392
	24 x 36-1/4"	CRFD6024A	<input type="checkbox"/>	PSTR	<input type="checkbox"/>	<input type="checkbox"/> <input type="checkbox"/>	123.0#	2381	2535
CRF									

A

B

C

D

E

HOW TO ORDER

- Indicate the following information on order form:
1. Quantity of each item.
 2. Model number, including options. See "How To Build a Model Number".
 3. Any special service required.

Note:

- The indicates that a choice is required.
- The absence of the indicates that no choice is required.
- Alpha-numeric characters in place of indicate that no other alternatives are available.

HOW TO BUILD A MODEL NUMBER

- A** Select basic model.
- B** Select wood type.
- | | |
|----------|---------|
| O | - Oak |
| M | - Maple |
- C** Select end panel.
- | | |
|-------------|------------------|
| PSTR | - Straight panel |
|-------------|------------------|
- D** Select back panel.
- | | |
|-----------|-------------------------|
| BP | - Back panel; add \$222 |
| NP | - No back panel |
- E** Select wood finish.
- Refer to the **Product Color Options** page in this price list.
- Stained finish colors; add \$103.

INFORMATION

Back Panel Weights

When ordering shelving with back panels add the following weights:

- 42" high add 15#
- 54" high add 18#
- 60" high add 20#
- 72" high add 24#
- 82" high add 27#
- 96" high add 35#

FINISH INFORMATION

Color Match

KI offers the additional option of color matching paint, polypropylene, or wood stain through Product Modification Requests, contact Customer Service for details.

SPECIAL SERVICES



Special Carton Marking

With specially marked information N/C

Shipping
Ships **knocked down, FOB Factory of origin, freight prepaid.** Freight class 125.

Specifications and prices are subject to change without prior notice.

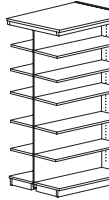

MODEL	D x W	MODEL NUMBER					Approx. Packaged Weight	Finish	
		Basic Model	Wood Type	End Panel	Back Panel	Wood Finish		Oak	Maple
 <p>Shelving Starter Unit-Single Face</p> <ul style="list-style-type: none"> Straight base only 2 straight end panels (1 left and 1 right) With or without back panel 4 adjustable, 1 fixed and 1 base shelf Recommended for use against wall only Anchors recommended Non-finished backside 	10 x 37-1/2"	CRFS7210S	<input type="checkbox"/>	<input type="checkbox"/> <input type="checkbox"/> <input type="checkbox"/> <input type="checkbox"/>	<input type="checkbox"/> <input type="checkbox"/>	<input type="checkbox"/> <input type="checkbox"/>	77.0#	\$ 1893	\$ 2012
	12 x 37-1/2"	CRFS7212S	<input type="checkbox"/>	<input type="checkbox"/> <input type="checkbox"/> <input type="checkbox"/> <input type="checkbox"/>	<input type="checkbox"/> <input type="checkbox"/>	<input type="checkbox"/> <input type="checkbox"/>	91.0#	2022	2147
	16 x 37-1/2"	CRFS7216S	<input type="checkbox"/>	<input type="checkbox"/> <input type="checkbox"/> <input type="checkbox"/> <input type="checkbox"/>	<input type="checkbox"/> <input type="checkbox"/>	<input type="checkbox"/> <input type="checkbox"/>	115.0#	2784	3147
CRF									
 <p>Shelving Adder Unit-Single Face</p> <ul style="list-style-type: none"> 1 straight adder (shared) panel only With or without back panel 4 adjustable, 1 fixed and 1 base shelf Recommended for use against wall only Anchors recommended Non-finished backside 	10 x 36-1/4"	CRFS7210A	<input type="checkbox"/>	PSTR	<input type="checkbox"/> <input type="checkbox"/>	<input type="checkbox"/> <input type="checkbox"/>	61.0#	\$ 1515	\$ 1610
	12 x 36-1/4"	CRFS7212A	<input type="checkbox"/>	PSTR	<input type="checkbox"/> <input type="checkbox"/>	<input type="checkbox"/> <input type="checkbox"/>	72.0#	1602	1707
	16 x 36-1/4"	CRFS7216A	<input type="checkbox"/>	PSTR	<input type="checkbox"/> <input type="checkbox"/>	<input type="checkbox"/> <input type="checkbox"/>	92.0#	2156	2506
CRF									
 <p>Shelving Starter Unit-Double Face</p> <ul style="list-style-type: none"> Straight base only 2 straight end panels (1 left and 1 right) With or without back panel 8 adjustable, 2 fixed and 2 base shelves 	20 x 37-1/2"	CRFD7220S	<input type="checkbox"/>	<input type="checkbox"/> <input type="checkbox"/> <input type="checkbox"/> <input type="checkbox"/>	<input type="checkbox"/> <input type="checkbox"/>	<input type="checkbox"/> <input type="checkbox"/>	151.0#	\$ 3194	\$ 3422
	24 x 37-1/2"	CRFD7224S	<input type="checkbox"/>	<input type="checkbox"/> <input type="checkbox"/> <input type="checkbox"/> <input type="checkbox"/>	<input type="checkbox"/> <input type="checkbox"/>	<input type="checkbox"/> <input type="checkbox"/>	200.0#	3447	3693
CRF									
 <p>Shelving Adder Unit-Double Face</p> <ul style="list-style-type: none"> 1 straight adder (shared) panel only With or without back panel 8 adjustable, 2 fixed and 2 base shelves 	20 x 36-1/4"	CRFD7220A	<input type="checkbox"/>	PSTR	<input type="checkbox"/> <input type="checkbox"/>	<input type="checkbox"/> <input type="checkbox"/>	120.0#	\$ 2630	\$ 2803
	24 x 36-1/4"	CRFD7224A	<input type="checkbox"/>	PSTR	<input type="checkbox"/> <input type="checkbox"/>	<input type="checkbox"/> <input type="checkbox"/>	139.0#	2827	3017
CRF									

A

B

C

D

E

HOW TO ORDER

- Indicate the following information on order form:
- Quantity of each item.
 - Model number, including options. See "How To Build a Model Number".
 - Any special service required.

Note:

- The indicates that a choice is required.
- The absence of the indicates that no choice is required.
- Alpha-numeric characters in place of indicate that no other alternatives are available.

HOW TO BUILD A MODEL NUMBER

- A** Select basic model.
- B** Select wood type.
- | | |
|----------|---------|
| O | - Oak |
| M | - Maple |
- C** Select end panel.
- | | |
|-------------|------------------|
| PSTR | - Straight panel |
|-------------|------------------|
- D** Select back panel.
- | | |
|-----------|-------------------------|
| BP | - Back panel; add \$262 |
| NP | - No back panel |
- E** Select wood finish.
- Refer to the **Product Color Options** page in this price list.
- Stained finish colors; add \$103.

INFORMATION

Back Panel Weights

When ordering shelving with back panels add the following weights:

- 42" high add 15#
- 54" high add 18#
- 60" high add 20#
- 72" high add 24#
- 82" high add 27#
- 96" high add 35#

FINISH INFORMATION

Color Match

KI offers the additional option of color matching paint, polypropylene, or wood stain through Product Modification Requests, contact Customer Service for details.

SPECIAL SERVICES





Special Carton Marking

With specially marked information N/C

Shipping

Ships **knocked down, FOB Factory of origin, freight prepaid**. Freight class 125.

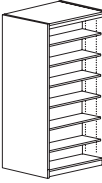
Specifications and prices are subject to change without prior notice.

MODEL	D x W	MODEL NUMBER					Approx. Packaged Weight	Finish	
		Basic Model	Wood Type	End Panel	Back Panel	Wood Finish		Oak	Maple
 <p>Shelving Starter Unit-Single Face</p> <ul style="list-style-type: none"> • Straight base only • 2 straight end panels (1 left and 1 right) • With or without back panel • 5 adjustable, 1 fixed and 1 base shelf • Recommended for use against wall only • Anchors recommended • Non-finished backside 	10 x 37-1/2"	CRFS8210S	<input type="checkbox"/>	<input type="checkbox"/> <input type="checkbox"/> <input type="checkbox"/> <input type="checkbox"/>	<input type="checkbox"/>	<input type="checkbox"/> <input type="checkbox"/>	87.0#	\$ 1971	\$ 2099
	12 x 37-1/2"	CRFS8212S	<input type="checkbox"/>	<input type="checkbox"/> <input type="checkbox"/> <input type="checkbox"/> <input type="checkbox"/>	<input type="checkbox"/>	<input type="checkbox"/> <input type="checkbox"/>	101.0#	2115	2248
	16 x 37-1/2"	CRFS8216S	<input type="checkbox"/>	<input type="checkbox"/> <input type="checkbox"/> <input type="checkbox"/> <input type="checkbox"/>	<input type="checkbox"/>	<input type="checkbox"/> <input type="checkbox"/>	127.0#	3000	3239
CRF									
 <p>Shelving Adder Unit-Single Face</p> <ul style="list-style-type: none"> • 1 straight adder (shared) panel only • With or without back panel • 5 adjustable, 1 fixed and 1 base shelf • Recommended for use against wall only • Anchors recommended • Non-finished backside 	10 x 36-1/4"	CRFS8210A	<input type="checkbox"/>	PSTR	<input type="checkbox"/>	<input type="checkbox"/> <input type="checkbox"/>	68.0#	\$ 1583	\$ 1683
	12 x 36-1/4"	CRFS8212A	<input type="checkbox"/>	PSTR	<input type="checkbox"/>	<input type="checkbox"/> <input type="checkbox"/>	81.0#	1670	1782
	16 x 36-1/4"	CRFS8216A	<input type="checkbox"/>	PSTR	<input type="checkbox"/>	<input type="checkbox"/> <input type="checkbox"/>	99.0#	2317	2704
CRF									
 <p>Shelving Starter Unit-Double Face</p> <ul style="list-style-type: none"> • Straight base only • 2 straight end panels (1 left and 1 right) • With or without back panel • 10 adjustable, 2 fixed and 2 base shelves 	20 x 37-1/2"	CRFD8220S	<input type="checkbox"/>	<input type="checkbox"/> <input type="checkbox"/> <input type="checkbox"/> <input type="checkbox"/>	<input type="checkbox"/>	<input type="checkbox"/> <input type="checkbox"/>	170.0#	\$ 3368	\$ 3605
	24 x 37-1/2"	CRFD8224S	<input type="checkbox"/>	<input type="checkbox"/> <input type="checkbox"/> <input type="checkbox"/> <input type="checkbox"/>	<input type="checkbox"/>	<input type="checkbox"/> <input type="checkbox"/>	198.0#	3633	3890
CRF									
 <p>Shelving Adder Unit-Double Face</p> <ul style="list-style-type: none"> • 1 straight adder (shared) panel only • With or without back panel • 10 adjustable, 2 fixed and 2 base shelves 	20 x 36-1/4"	CRFD8220A	<input type="checkbox"/>	PSTR	<input type="checkbox"/>	<input type="checkbox"/> <input type="checkbox"/>	135.0#	\$ 2752	\$ 2942
	24 x 36-1/4"	CRFD8224A	<input type="checkbox"/>	PSTR	<input type="checkbox"/>	<input type="checkbox"/> <input type="checkbox"/>	155.0#	2971	3175
CRF									

A

B

C

D

E

HOW TO ORDER

- Indicate the following information on order form:
1. Quantity of each item.
 2. Model number, including options. See "How To Build a Model Number".
 3. Any special service required.

Note: • The indicates that a choice is required.
 • The absence of the indicates that no choice is required.
 • Alpha-numeric characters in place of indicate that no other alternatives are available.

HOW TO BUILD A MODEL NUMBER

- A** Select basic model.
- B** Select wood type.
O - Oak
M - Maple
- C** Select end panel.
PSTR - Straight panel
- D** Select back panel.
BP - Back panel; add \$293
NP - No back panel
- E** Select wood finish.
 Refer to the **Product Color Options** page in this price list.
 Stained finish colors; add \$111.

INFORMATION**Back Panel Weights**

When ordering shelving with back panels add the following weights:
 42" high add 15#
 54" high add 18#
 60" high add 20#
 72" high add 24#
 82" high add 27#
 96" high add 35#

FINISH INFORMATION**Color Match**

KI offers the additional option of color matching paint, polypropylene, or wood stain through Product Modification Requests, contact Customer Service for details.



SPECIAL SERVICES**Special Carton Marking**

With specially marked information N/C

Shipping
 Ships **knocked down, FOB Factory of origin, freight prepaid.** Freight class 125.

Specifications and prices are subject to change without prior notice.

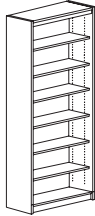

MODEL	D x W	MODEL NUMBER					Approx. Packaged Weight	Oak	Maple
		Basic Model	Wood Type	End Panel	Back Panel	Wood Finish			
 <p>Shelving Starter Unit-Single Face • Straight base only • 2 straight end panels (1 left and 1 right) • With or without back panel • 5 adjustable, 1 fixed and 1 base shelf • Recommended for use against wall only • Anchors recommended • Non-finished backside</p>	12 x 37-1/2"	CRFS9612S	<input type="checkbox"/>	<input type="checkbox"/> <input type="checkbox"/> <input type="checkbox"/> <input type="checkbox"/>	<input type="checkbox"/>	<input type="checkbox"/> <input type="checkbox"/>	124.0#	\$ 2381	\$ 2535
CRF									
 <p>Shelving Adder Unit-Single Face • 1 straight adder (shared) panel only • With or without back panel • 5 adjustable, 1 fixed and 1 base shelf • Recommended for use against wall only • Anchors recommended • Non-finished backside</p>	12 x 36-1/4"	CRFS9612A	<input type="checkbox"/>	PSTR	<input type="checkbox"/>	<input type="checkbox"/> <input type="checkbox"/>	96.0#	\$ 1826	\$ 1949
CRF									

A **B** **C** **D** **E**

HOW TO ORDER

- Indicate the following information on order form:
- Quantity of each item.
 - Model number, including options. See "How To Build a Model Number".
 - Any special service required.

Note:

- The indicates that a choice is required.
- The absence of the indicates that no choice is required.
- Alpha-numeric characters in place of indicate that no other alternatives are available.

HOW TO BUILD A MODEL NUMBER

- A** Select basic model.
- B** Select wood type.

O	- Oak
M	- Maple
- C** Select end panel.

PSTR	- Straight panel
-------------	------------------
- D** Select back panel.

BP	- Back panel; add \$319
NP	- No back panel
- E** Select wood finish.
 Refer to the **Product Color Options** page in this price list.
 Stained finish colors; add \$111.

INFORMATION

Back Panel Weights
 When ordering shelving with back panels add the following weights:
 42" high add 15#
 54" high add 18#
 60" high add 20#
 72" high add 24#
 82" high add 27#
 96" high add 35#

FINISH INFORMATION

Color Match
 KI offers the additional option of color matching paint, polypropylene, or wood stain through Product Modification Requests, contact Customer Service for details.

SPECIAL SERVICES

Special Carton Marking

With specially marked information N/C

Shipping
 Ships **knocked down, FOB Factory of origin, freight prepaid.** Freight class 125.

Specifications and prices are subject to change without prior notice.

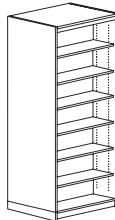
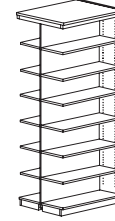

	MODEL	D x W	MODEL NUMBER					Approx. Packaged Weight	Finish	
			Basic Model	Wood Type	End Panel	Back Panel	Wood Finish		Oak	Maple
	Shelving Starter Unit-Double Face • Straight base only • 2 straight end panels (1 left and 1 right) • With or without back panel • 10 adjustable, 2 fixed and 2 base shelves	24 x 37-1/2"	CRFD9624S	<input type="checkbox"/>	<input type="checkbox"/> <input type="checkbox"/> <input type="checkbox"/> <input type="checkbox"/>	<input type="checkbox"/>	<input type="checkbox"/> <input type="checkbox"/>	244.0#	\$ 4181	\$ 4484
CRF		24 x 36-1/4"	CRFD9624A	<input type="checkbox"/>	PSTR	<input type="checkbox"/>	<input type="checkbox"/> <input type="checkbox"/>	185.0#	\$ 3277	\$ 3512
CRF										

A **B** **C** **D** **E**

FINISH INFORMATION

Color Match

KI offers the additional option of color matching paint, polypropylene, or wood stain through Product Modification Requests, contact Customer Service for details.

HOW TO ORDER

- Indicate the following information on order form:
- Quantity of each item.
 - Model number, including options. See "How To Build a Model Number".
 - Any special service required.

Note:

- The indicates that a choice is required.
- The absence of the indicates that no choice is required.
- Alpha-numeric characters in place of indicate that no other alternatives are available.

HOW TO BUILD A MODEL NUMBER

- A** Select basic model.
- B** Select wood type.

O	- Oak
M	- Maple
- C** Select end panel.

PSTR	- Straight panel
-------------	------------------
- D** Select back panel.

BP	- Back panel; add \$319
NP	- No back panel
- E** Select wood finish. Refer to the **Product Color Options** page in this price list. Stained finish colors; add \$111.

INFORMATION

Back Panel Weights

When ordering shelving with back panels add the following weights:

- 42" high add 15#
- 54" high add 18#
- 60" high add 20#
- 72" high add 24#
- 82" high add 27#
- 96" high add 35#

SPECIAL SERVICES

Special Carton Marking





With specially marked information N/C

Shipping

Ships **knocked down, FOB Factory of origin, freight prepaid.** Freight class 125.

Specifications and prices are subject to change without prior notice.

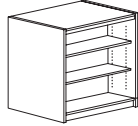

MODEL	D x W	MODEL NUMBER							Approx. Packaged Weight	Price		Book Stop Shelf add to list price
		Basic Model	Wood Type	Back Panel	Shelf Type	End Panel	Wood Finish	Paint Color		Oak	Maple	
 CRSS Metal Shelving Starter Unit-Single Face 12 x 37-1/2" • Straight base only • 2 straight end panels (1 left and 1 right) • With or without back panel • 2 adjustable & 1 wood bottom base shelf • Recommended for use against wall only • Anchors recommended • Non-finished backside		CRSSS4212S	<input type="checkbox"/>	<input type="checkbox"/>	<input type="checkbox"/>	<input type="checkbox"/>	<input type="checkbox"/>	SA	57.0#	\$ 1292	\$ 1359	\$ 32
 CRSS Metal Shelving Adder Unit-Single Face 12 x 36-1/4" • 1 straight adder (shared) panel only • With or without back panel • 2 adjustable & 1 wood bottom base shelf • Recommended for use against wall only • Anchors recommended • Non-finished backside		CRSSS4212A	<input type="checkbox"/>	<input type="checkbox"/>	<input type="checkbox"/>	PSTR	<input type="checkbox"/>	SA	47.0#	\$ 1038	\$ 1098	\$ 32
 CRSS Metal Shelving Starter Unit-Double Face 24 x 37-1/2" • Straight base only • 2 straight end panels (1 left and 1 right) • With or without back panel • 4 adjustable & 2 wood bottom base shelves		CRSSD4224S	<input type="checkbox"/>	<input type="checkbox"/>	<input type="checkbox"/>	<input type="checkbox"/>	<input type="checkbox"/>	SA	117.0#	\$ 2062	\$ 2201	\$ 64
 CRSS Metal Shelving Adder Unit-Double Face 24 x 36-1/4" • 1 straight adder (shared) panel only • With or without back panel • 4 adjustable & 2 wood bottom base shelves		CRSSD4224A	<input type="checkbox"/>	<input type="checkbox"/>	<input type="checkbox"/>	PSTR	<input type="checkbox"/>	SA	95.0#	\$ 1715	\$ 1822	\$ 64

A **B** **C** **D** **E** **F** **G**

HOW TO ORDER

- Indicate the following information on order form:
- Quantity of each item.
 - Model number, including options. See "How To Build a Model Number".
 - Any special service required.

Note: • The indicates that a choice is required.
 • The absence of the indicates that no choice is required.
 • Alpha-numeric characters in place of indicate that no other alternatives are available.

HOW TO BUILD A MODEL NUMBER

- A** Select basic model.
 O - Oak
 M - Maple
- C** Select back panel.
 BP - Back panel; add \$186
 NP - No back panel
- D** Select shelf type.
 B - Book stop shelf
 F - Flat shelf
 Book stop shelf is NOT available with Back panel.
 See pricing column for book stop shelf upcharge.
- E** Select end panel
 PSTR - Straight panel

F Select wood finish.
 Refer to the **Product Color Options** page in this price list.
 Stained finish colors; add \$66.

G Select shelf paint color.
 SA - Sand
 Refer to the **Product Color Options** page in this price list.

INFORMATION

Back Panel Weights
 When ordering shelving with back panels add the following weights:
 42" high add 15#
 54" high add 18#
 60" high add 20#
 72" high add 24#
 82" high add 27#

FINISH INFORMATION

Color Match
 KI offers the additional option of color matching paint, polypropylene, or wood stain through Product Modification Requests, contact Customer Service for details.





SPECIAL SERVICES

Special Carton Marking
 With specially marked information N/C

Shipping
 Ships **knocked down, FOB Factory of origin, freight prepaid.** Freight class 125.

Specifications and prices are subject to change without prior notice.



MODEL	D x W	MODEL NUMBER							Approx. Packaged Weight	Color		Book Stop Shelf add to list price
		Basic Model	Wood Type	Back Panel	Shelf Type	End Panel	Wood Finish	Paint Color		Oak	Maple	
 Metal Shelving Starter Unit-Single Face 12 x 37-1/2" • Straight base only • 2 straight end panels (1 left and 1 right) • With or without back panel • 3 adjustable & 1 wood bottom base shelf • Recommended for use against wall only • Anchors recommended • Non-finished backside	12 x 37-1/2"	CRSSS5412S	<input type="checkbox"/>	<input type="checkbox"/>	<input type="checkbox"/>	<input type="checkbox"/>	<input type="checkbox"/>	SA	69.0#	\$ 1504	\$ 1594	\$ 48
CRSS												
 Metal Shelving Adder Unit-Single Face 12 x 36-1/4" • 1 straight adder (shared) panel only • With or without back panel • 3 adjustable & 1 wood bottom base shelf • Recommended for use against wall only • Anchors recommended • Non-finished backside	12 x 36-1/4"	CRSSS5412A	<input type="checkbox"/>	<input type="checkbox"/>	<input type="checkbox"/>	PSTR	<input type="checkbox"/>	SA	55.0#	\$ 1203	\$ 1276	\$ 48
CRSS												
 Metal Shelving Starter Unit-Double Face 24 x 37-1/2" • Straight base only • 2 straight end panels (1 left and 1 right) • With or without back panel • 6 adjustable & 2 wood bottom base shelves	24 x 37-1/2"	CRSSD5424S	<input type="checkbox"/>	<input type="checkbox"/>	<input type="checkbox"/>	<input type="checkbox"/>	<input type="checkbox"/>	SA	135.0#	\$ 2465	\$ 2630	\$ 97
CRSS												
 Metal Shelving Adder Unit-Double Face 24 x 36-1/4" • 1 straight adder (shared) panel only • With or without back panel • 6 adjustable & 2 wood bottom base shelves	24 x 36-1/4"	CRSSD5424A	<input type="checkbox"/>	<input type="checkbox"/>	<input type="checkbox"/>	PSTR	<input type="checkbox"/>	SA	107.0#	\$ 2032	\$ 2169	\$ 97
CRSS												

A **B** **C** **D** **E** **F** **G**

HOW TO ORDER

- Indicate the following information on order form:
- Quantity of each item.
 - Model number, including options. See "How To Build a Model Number".
 - Any special service required.

Note: • The indicates that a choice is required.
 • The absence of the indicates that no choice is required.
 • Alpha-numeric characters in place of indicate that no other alternatives are available.

HOW TO BUILD A MODEL NUMBER

- A** Select basic model.

- B** Select wood type.
O - Oak
M - Maple
- C** Select back panel.
BP - Back panel; add \$211
NP - No back panel
- D** Select shelf type.
B - Book stop shelf
F - Flat shelf
 Book stop shelf is NOT available with Back panel.
 See pricing column for book stop shelf upcharge.
- E** Select end panel
PSTR - Straight panel
- F** Select wood finish.
 Refer to the **Product Color Options** page in this price list.
 Stained finish colors; add \$66.
- G** Select shelf paint color.
SA - Sand
 Refer to the **Product Color Options** page in this price list.

INFORMATION

Back Panel Weights
 When ordering shelving with back panels add the following weights:
 42" high add 15#
 54" high add 18#
 60" high add 20#
 72" high add 24#
 82" high add 27#

FINISH INFORMATION

Color Match
 KI offers the additional option of color matching paint, polypropylene, or wood stain through Product Modification Requests, contact Customer Service for details.



SPECIAL SERVICES

Special Carton Marking
 With specially marked information N/C

Shipping
 Ships **knocked down, FOB Factory of origin, freight prepaid.** Freight class 125.

Specifications and prices are subject to change without prior notice.

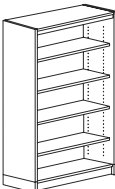
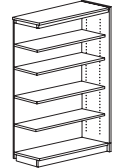

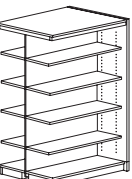
MODEL	D x W	MODEL NUMBER							Approx. Packaged Weight	Color		Book Stop Shelf add to list price
		Basic Model	Wood Type	Back Panel	Shelf Type	End Panel	Wood Finish	Paint Color		Oak	Maple	
 <p>Metal Shelving Starter Unit-Single Face • Straight base only • 2 straight end panels (1 left and 1 right) • With or without back panel • 4 adjustable & 1 wood bottom base shelf • Recommended for use against wall only • Anchors recommended • Non-finished backside</p>	12 x 37-1/2"	CRSSS6012S	<input type="checkbox"/>	<input type="checkbox"/>	<input type="checkbox"/>	<input type="checkbox"/>	<input type="checkbox"/>	SA	81.0#	\$ 1577	\$ 1672	\$ 64
	CRSS											
 <p>Metal Shelving Adder Unit-Single Face • 1 straight adder (shared) panel only • With or without back panel • 4 adjustable & 1 wood bottom base shelf • Recommended for use against wall only • Anchors recommended • Non-finished backside</p>	12 x 36-1/4"	CRSSS6012A	<input type="checkbox"/>	<input type="checkbox"/>	<input type="checkbox"/>	PSTR	<input type="checkbox"/>	SA	63.0#	\$ 1256	\$ 1337	\$ 64
	CRSS											
 <p>Metal Shelving Starter Unit-Double Face • Straight base only • 2 straight end panels (1 left and 1 right) • With or without back panel • 8 adjustable & 2 wood bottom base shelves</p>	24 x 37-1/2"	CRSSD6024S	<input type="checkbox"/>	<input type="checkbox"/>	<input type="checkbox"/>	<input type="checkbox"/>	<input type="checkbox"/>	SA	154.0#	\$ 2600	\$ 2775	\$ 129
	CRSS											
 <p>Metal Shelving Adder Unit-Double Face • 1 straight adder (shared) panel only • With or without back panel • 8 adjustable & 2 wood bottom base shelves</p>	24 x 36-1/4"	CRSSD6024A	<input type="checkbox"/>	<input type="checkbox"/>	<input type="checkbox"/>	PSTR	<input type="checkbox"/>	SA	123.0#	\$ 2143	\$ 2282	\$ 129
	CRSS											

A **B** **C** **D** **E** **F** **G**

HOW TO ORDER

- Indicate the following information on order form:
- Quantity of each item.
 - Model number, including options. See "How To Build a Model Number".
 - Any special service required.

Note: • The indicates that a choice is required.
 • The absence of the indicates that no choice is required.
 • Alpha-numeric characters in place of indicate that no other alternatives are available.

HOW TO BUILD A MODEL NUMBER

- A** Select basic model.
- B** Select wood type.
 O - Oak
 M - Maple
- C** Select back panel.
 BP - Back panel; add \$222
 NP - No back panel
- D** Select shelf type.
 B - Book stop shelf
 F - Flat shelf
 Book stop shelf is NOT available with Back panel.
 See pricing column for book stop shelf upcharge.
- E** Select end panel
 PSTR - Straight panel

F Select wood finish.
 Refer to the **Product Color Options** page in this price list.
 Stained finish colors; add \$84.

G Select shelf paint color.
 SA - Sand
 Refer to the **Product Color Options** page in this price list.

INFORMATION

Back Panel Weights
 When ordering shelving with back panels add the following weights:
 42" high add 15#
 54" high add 18#
 60" high add 20#
 72" high add 24#
 82" high add 27#

FINISH INFORMATION

Color Match
 KI offers the additional option of color matching paint, polypropylene, or wood stain through Product Modification Requests, contact Customer Service for details.



SPECIAL SERVICES

Special Carton Marking
 With specially marked information N/C

Shipping
 Ships **knocked down, FOB Factory of origin, freight prepaid.** Freight class 125.

Specifications and prices are subject to change without prior notice.

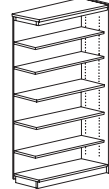

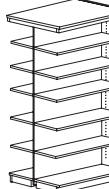
MODEL	D x W	MODEL NUMBER							Approx. Packaged Weight	Finish		Book Stop Shelf add to list price
		Basic Model	Wood Type	Back Panel	Shelf Type	End Panel	Wood Finish	Paint Color		Oak	Maple	
 Metal Shelving Starter Unit-Single Face 12 x 37-1/2" • Straight base only • 2 straight end panels (1 left and 1 right) • With or without back panel • 5 adjustable & 1 wood bottom base shelf • Recommended for use against wall only • Anchors recommended • Non-finished backside	12 x 37-1/2"	CRSSS7212S	<input type="checkbox"/>	<input type="checkbox"/>	<input type="checkbox"/>	<input type="checkbox"/>	<input type="checkbox"/>	SA	91.0#	\$ 1821	\$ 1930	\$ 82
CRSS												
 Metal Shelving Adder Unit-Single Face 12 x 36-1/4" • 1 straight adder (shared) panel only • With or without back panel • 5 adjustable & 1 wood bottom base shelf • Recommended for use against wall only • Anchors recommended • Non-finished backside	12 x 36-1/4"	CRSSS7212A	<input type="checkbox"/>	<input type="checkbox"/>	<input type="checkbox"/>	PSTR	<input type="checkbox"/>	SA	72.0#	\$ 1444	\$ 1537	\$ 82
CRSS												
 Metal Shelving Starter Unit-Double Face 24 x 37-1/2" • Straight base only • 2 straight end panels (1 left and 1 right) • With or without back panel • 10 adjustable & 2 wood bottom base shelves	24 x 37-1/2"	CRSSD7224S	<input type="checkbox"/>	<input type="checkbox"/>	<input type="checkbox"/>	<input type="checkbox"/>	<input type="checkbox"/>	SA	200.0#	\$ 3101	\$ 3323	\$ 159
CRSS												
 Metal Shelving Adder Unit-Double Face 24 x 36-1/4" • 1 straight adder (shared) panel only • With or without back panel • 10 adjustable & 2 wood bottom base shelves	24 x 36-1/4"	CRSSD7224A	<input type="checkbox"/>	<input type="checkbox"/>	<input type="checkbox"/>	PSTR	<input type="checkbox"/>	SA	139.0#	\$ 2544	\$ 2716	\$ 159
CRSS												

A **B** **C** **D** **E** **F** **G**

HOW TO ORDER

- Indicate the following information on order form:
- Quantity of each item.
 - Model number, including options. See "How To Build a Model Number".
 - Any special service required.

Note: • The indicates that a choice is required.
 • The absence of the indicates that no choice is required.
 • Alpha-numeric characters in place of indicate that no other alternatives are available.

HOW TO BUILD A MODEL NUMBER

- A** Select basic model.

- B** Select wood type.
 O - Oak
 M - Maple

- C** Select back panel.
 BP - Back panel; add \$262
 NP - No back panel

- D** Select shelf type.
 B - Book stop shelf
 F - Flat shelf
 Book stop shelf is NOT available with Back panel.
 See pricing column for book stop shelf upcharge.

- E** Select end panel
 PSTR - Straight panel

- F** Select wood finish.
 Refer to the **Product Color Options** page in this price list.
 Stained finish colors; add \$84.

- G** Select shelf paint color.
 SA - Sand
 Refer to the **Product Color Options** page in this price list.

INFORMATION

Back Panel Weights
 When ordering shelving with back panels add the following weights:
 42" high add 15#
 54" high add 18#
 60" high add 20#
 72" high add 24#
 82" high add 27#

FINISH INFORMATION

Color Match
 KI offers the additional option of color matching paint, polypropylene, or wood stain through Product Modification Requests, contact Customer Service for details.



SPECIAL SERVICES

Special Carton Marking
 With specially marked information N/C

Shipping
 Ships **knocked down, FOB Factory of origin, freight prepaid.** Freight class 125.

Specifications and prices are subject to change without prior notice.

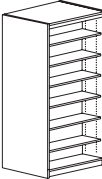
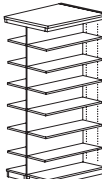

MODEL	D x W	MODEL NUMBER							Approx. Packaged Weight	Finish		Book Stop Shelf add to list price
		Basic Model	Wood Type	Back Panel	Shelf Type	End Panel	Wood Finish	Paint Color		Oak	Maple	
 <p>Metal Shelving Starter Unit-Single Face • Straight base only • 2 straight end panels (1 left and 1 right) • With or without back panel • 6 adjustable & 1 wood bottom base shelf • Recommended for use against wall only • Anchors recommended • Non-finished backside</p>	12 x 37-1/2"	CRSSS8212S	<input type="checkbox"/>	<input type="checkbox"/>	<input type="checkbox"/>	<input type="checkbox"/>	<input type="checkbox"/>	SA	101.0#	\$ 1903	\$ 2022	\$ 97
CRSS												
 <p>Metal Shelving Adder Unit-Single Face • 1 straight adder (shared) panel only • With or without back panel • 6 adjustable & 1 wood bottom base shelf • Recommended for use against wall only • Anchors recommended • Non-finished backside</p>	12 x 36-1/4"	CRSSS8212A	<input type="checkbox"/>	<input type="checkbox"/>	<input type="checkbox"/>	PSTR	<input type="checkbox"/>	SA	81.0#	\$ 1504	\$ 1602	\$ 97
CRSS												
 <p>Metal Shelving Starter Unit-Double Face • Straight base only • 2 straight end panels (1 left and 1 right) • With or without back panel • 12 adjustable & 2 wood bottom base shelves</p>	24 x 37-1/2"	CRSSD8224S	<input type="checkbox"/>	<input type="checkbox"/>	<input type="checkbox"/>	<input type="checkbox"/>	<input type="checkbox"/>	SA	198.0#	\$ 3268	\$ 3503	\$ 190
CRSS												
 <p>Metal Shelving Adder Unit-Double Face • 1 straight adder (shared) panel only • With or without back panel • 12 adjustable & 2 wood bottom base shelves</p>	24 x 36-1/4"	CRSSD8224A	<input type="checkbox"/>	<input type="checkbox"/>	<input type="checkbox"/>	PSTR	<input type="checkbox"/>	SA	155.0#	\$ 2675	\$ 2857	\$ 190
CRSS												

A **B** **C** **D** **E** **F** **G**

HOW TO ORDER

- Indicate the following information on order form:
- Quantity of each item.
 - Model number, including options. See "How To Build a Model Number".
 - Any special service required.

Note: • The indicates that a choice is required.
 • The absence of the indicates that no choice is required.
 • Alpha-numeric characters in place of indicate that no other alternatives are available.

HOW TO BUILD A MODEL NUMBER

- A** Select basic model.
- B** Select wood type.
 O - Oak
 M - Maple
- C** Select back panel.
 BP - Back panel; add \$293
 NP - No back panel
- D** Select shelf type.
 B - Book stop shelf
 F - Flat shelf
 Book stop shelf is NOT available with Back panel.
 See pricing column for book stop shelf upcharge.
- E** Select end panel
 PSTR - Straight panel
- F** Select wood finish.
 Refer to the **Product Color Options** page in this price list.
 Stained finish colors; add \$89.
- G** Select shelf paint color.
 SA - Sand
 Refer to the **Product Color Options** page in this price list.

INFORMATION

Back Panel Weights
 When ordering shelving with back panels add the following weights:
 42" high add 15#
 54" high add 18#
 60" high add 20#
 72" high add 24#
 82" high add 27#

FINISH INFORMATION

Color Match
 KI offers the additional option of color matching paint, polypropylene, or wood stain through Product Modification Requests, contact Customer Service for details.

SPECIAL SERVICES

Special Carton Marking
 With specially marked information N/C

Shipping
 Ships **knocked down, FOB Factory of origin, freight prepaid.** Freight class 125.

Specifications and prices are subject to change without prior notice.

CrossRoads® Periodical Shelving

42" High Periodical Shelving



CrossRoads® Periodical Shelving

42" High Periodical Shelving

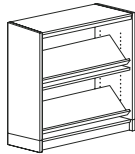
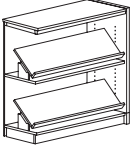
MODEL	D x W x H	MODEL NUMBER				Approx. Packaged Weight	Approx. Price	
		Basic Model	Wood Type	End Panel	Wood Finish		Oak	Maple
 <p>42" Periodical Shelving Starter Unit-Single Face</p> <ul style="list-style-type: none"> • Straight base only with back panel • 2 adjustable pivoted shelves • Straight end panel • Recommended for use against wall only • Anchors recommended • Non-finished backside 	12 x 37-1/2 x 42"	CRPERS4212S	<input type="checkbox"/>	<input type="checkbox"/> <input type="checkbox"/> <input type="checkbox"/> <input type="checkbox"/>	<input type="checkbox"/> <input type="checkbox"/>	92.0#	\$ 5019	\$ 5519
CRPER								
 <p>42" Periodical Shelving Adder Unit-Single Face</p> <ul style="list-style-type: none"> • Straight base only with back panel • 2 adjustable pivoted shelves • Straight end panel only • Recommended for use against wall only • Anchors recommended • Non-finished backside 	12 x 36-1/4 x 42"	CRPERS4212A	<input type="checkbox"/>	PSTR	<input type="checkbox"/> <input type="checkbox"/>	82.0#	\$ 4279	\$ 4703
CRPER								

A

B

C

D

HOW TO ORDER

- Indicate the following information on order form:
1. Quantity of each item.
 2. Model number, including options. See "How To Build a Model Number".
 3. Any special service required.

- Note:
- The indicates that a choice is required.
 - The absence of the indicates that no choice is required.
 - Alpha-numeric characters in place of indicate that no other alternatives are available.

HOW TO BUILD A MODEL NUMBER

- A** Select basic model.
- B** Select wood type.
- | | |
|----------|---------|
| O | - Oak |
| M | - Maple |
- C** Select end panel.
- | | |
|-------------|------------------|
| PSTR | - Straight panel |
|-------------|------------------|
- D** Select wood finish.
- Refer to the **Product Color Options** page in this price list.
- Stained finish colors; add \$112.

FINISH INFORMATION

Color Match

KI offers the additional option of color matching paint, polypropylene, or wood stain through Product Modification Requests, contact Customer Service for details.

SPECIAL SERVICES

Special Carton Marking

With specially marked information N/C

Shipping

Ships **knocked down, FOB Factory of origin, freight prepaid**. Freight class 125.

Specifications and prices are subject to change without prior notice.

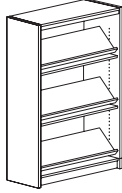
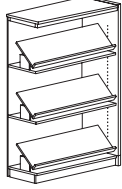

MODEL	D x W x H	MODEL NUMBER				Approx. Packaged Weight	Approx. Price	
		Basic Model	Wood Type	End Panel	Wood Finish		Oak	Maple
 <p>60" Periodical Shelving Starter Unit-Single Face</p> <ul style="list-style-type: none"> • Straight base only with back panel • 3 adjustable pivoted shelves • Straight end panel • Recommended for use against wall only • Anchors recommended • Non-finished backside 	12 x 37-1/2 x 60"	CRPERS6012S	<input type="checkbox"/>	<input type="checkbox"/> <input type="checkbox"/> <input type="checkbox"/> <input type="checkbox"/>	<input type="checkbox"/> <input type="checkbox"/>	121.0#	\$ 5861	\$ 6444
CRPER								
 <p>60" Periodical Shelving Adder Unit-Single Face</p> <ul style="list-style-type: none"> • Straight base only with back panel • 3 adjustable pivoted shelves • Straight end panel only • Recommended for use against wall only • Anchors recommended • Non-finished backside 	12 x 36-1/4 x 60"	CRPERS6012A	<input type="checkbox"/>	PSTR	<input type="checkbox"/> <input type="checkbox"/>	103.0#	\$ 5111	\$ 5623
CRPER								

A **B** **C** **D**

HOW TO ORDER

- Indicate the following information on order form:
1. Quantity of each item.
 2. Model number, including options. See "How To Build a Model Number".
 3. Any special service required.

Note:

- The indicates that a choice is required.
- The absence of the indicates that no choice is required.
- Alpha-numeric characters in place of indicate that no other alternatives are available.

HOW TO BUILD A MODEL NUMBER

- A** Select basic model.
- B** Select wood type.

O	- Oak
M	- Maple
- C** Select end panel.

PSTR	- Straight panel
-------------	------------------
- D** Select wood finish (for edge & sides). Refer to the **Product Color Options** page in this price list. Stained finish colors; add \$112.

FINISH INFORMATION

Color Match
 KI offers the additional option of color matching paint, polypropylene, or wood stain through Product Modification Requests, contact Customer Service for details.



SPECIAL SERVICES

Special Carton Marking
 With specially marked information N/C

Shipping
 Ships **knocked down, FOB Factory of origin, freight prepaid.** Freight class 125.

Specifications and prices are subject to change without prior notice.

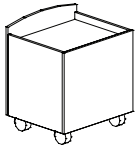

MODEL	D x W x H	MODEL NUMBER					Approx. Packaged Weight	Approx. Price	
		Basic Model	Wood Type	Wood Finish	Surface Finish	Pull Color		Oak	Maple
 <p>Descending Platform Book Truck • Sits under the Book Return Module • 4 swivel casters</p>	22 x 26 x 28-1/2"	CRDBT	<input type="checkbox"/>	<input type="checkbox"/> <input type="checkbox"/> <input type="checkbox"/>			84.0#	\$ 3663	\$ 4028
 <p>Wood Mobile Pedestal • Box/Box/File - (2) 6" drawers and (1) 12" drawer • Top drawer is locking</p>	19-23/32 x 16-3/8 x 26-13/16"	CRDMP	<input type="checkbox"/>	<input type="checkbox"/> <input type="checkbox"/> <input type="checkbox"/>	<input type="checkbox"/> <input type="checkbox"/> <input type="checkbox"/>	<input type="checkbox"/> <input type="checkbox"/> <input type="checkbox"/>	60.0#	\$ 1591	\$ 1751

A **B** **C** **D** **E**

HOW TO ORDER

- Indicate the following information on order form:
- Quantity of each item.
 - Model number, including options. See "How To Build a Model Number".
 - Any special service required.

Note:

- The indicates that a choice is required.
- The absence of the indicates that no choice is required.
- Alpha-numeric characters in place of indicate that no other alternatives are available.

HOW TO BUILD A MODEL NUMBER

A Select basic model.
 For a complete circulation desk price quotation, a sketch or drawing of the modular arrangement must be included.

B Select wood type.
O - Oak
M - Maple

C Select wood finish. (for worksurface edge, shelf, side & back panels)
 Refer to the **Product Color Options** page in this price list.
 Stained finish colors; add \$106.

D Select surface finish.
 Refer to the **Product Color Options** page in this price list.
 Additional plastic laminate surfaces are available but may require an upcharge and additional leadtime. Please contact KI.

E Select drawer pull color.
 Refer to the **Product Color Options** page in this price list.

FINISH INFORMATION

Color Match
 KI offers the additional option of color matching paint, polypropylene, or wood stain through Product Modification Requests, contact Customer Service for details.

SPECIAL SERVICES

Special Carton Marking

With specially marked information N/C

Shipping

Ships **assembled, FOB Factory of origin, freight prepaid.** Freight class 100.

Specifications and prices are subject to change without prior notice.

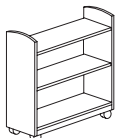
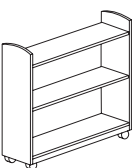
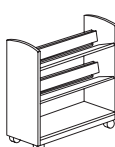
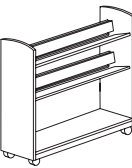

MODEL	D x W x H	MODEL NUMBER			Approx. Packaged Weight	Approx. Price	
		Basic Model	Wood Type	Wood Finish		Oak	Maple
 <p>Rolling Book Cart-30" Wide • 3 flat shelves • Lower shelf clearance 13" • Middle shelf clearance 11-1/4"</p>	14-1/2 x 29-7/8 x 36-11/64"	CRTRK3530	<input type="checkbox"/>	<input type="checkbox"/> <input type="checkbox"/> <input type="checkbox"/>	43.0#	\$ 1469	\$ 1614
CRTRK							
 <p>Rolling Book Cart-40" Wide • 3 flat shelves • Lower shelf clearance 14-5/16" • Middle shelf clearance 14-5/16"</p>	14-1/2 x 39-7/8 x 43-17/32"	CRTRK4140	<input type="checkbox"/>	<input type="checkbox"/> <input type="checkbox"/> <input type="checkbox"/>	43.0#	\$ 1672	\$ 1840
CRTRK							
 <p>Rolling Book Cart with Slanted Shelves • 2 double-face slanted shelves • 1 flat shelf • Lower shelf clearance 11-7/16" • Middle shelf clearance 8-7/8"</p>	14-1/2 x 29-7/8 x 38-13/16"	CRTRK3530SL	<input type="checkbox"/>	<input type="checkbox"/> <input type="checkbox"/> <input type="checkbox"/>	43.0#	\$ 2050	\$ 2258
CRTRK							
 <p>Rolling Book Cart with Slanted Shelves • 2 double-face slanted shelves • 1 flat shelf • Lower shelf clearance 17-7/16" • Middle shelf clearance 8-7/8"</p>	14-1/2 x 39-7/8 x 44-51/64"	CRTRK4140SL	<input type="checkbox"/>	<input type="checkbox"/> <input type="checkbox"/> <input type="checkbox"/>	43.0#	\$ 2415	\$ 2659
CRTRK							

A **B** **C**

HOW TO ORDER

- Indicate the following information on order form:
- Quantity of each item.
 - Model number, including options. See "How To Build a Model Number".
 - Any special service required.

Note: • The indicates that a choice is required.
 • The absence of the indicates that no choice is required.
 • Alpha-numeric characters in place of indicate that no other alternatives are available.

HOW TO BUILD A MODEL NUMBER

- A** Select basic model.
- B** Select wood type.
O - Oak
M - Maple
- C** Select wood finish.
 Refer to the **Product Color Options** page in this price list.
 Stained finish colors add \$106.

FINISH INFORMATION

Color Match
 KI offers the additional option of color matching paint, polypropylene, or wood stain through Product Modification Requests, contact Customer Service for details.

SPECIAL SERVICES

Special Carton Marking





With specially marked information N/C

Shipping

Ships **assembled, FOB Factory of origin, freight prepaid.** Freight class 100.

Specifications and prices are subject to change without prior notice.



MODEL	SEAT HEIGHT	MODEL NUMBER				Approx. Packaged Weight	Delivered Pricing Unupholstered	Delivered Pricing Fabric Grade 1 & C.O.M.	Delivered Pricing Fabric Grade 2	Delivered Pricing Fabric Grade 3	Delivered Pricing Vinyl Group 2V	Delivered Pricing Pallas Fabric Group P0	Delivered Pricing Pallas Fabric Group P1	Delivered Pricing Pallas Fabric Group P2	Delivered Pricing Pallas Fabric Group P3	Delivered Pricing Pallas Fabric Group P4
		Basic Model	Wood Type	Wood Finish	Upholstery Color											
 CRCHR	18"	CRCHR18	<input type="checkbox"/>	<input type="checkbox"/> <input type="checkbox"/> <input type="checkbox"/>		35.0#	\$ 608									
 CRCHR	19-1/2" • C.O.M = .75 yd	CRCHRU18	<input type="checkbox"/>	<input type="checkbox"/> <input type="checkbox"/> <input type="checkbox"/> <input type="checkbox"/> <input type="checkbox"/>		37.0#	N/A	\$ 950	\$ 995	\$ 1021	\$ 1021	\$ 999	\$ 1052	\$ 1105	\$ 1194	\$ 1250
 CRCHR	18"	CRCHRA18	<input type="checkbox"/>	<input type="checkbox"/> <input type="checkbox"/> <input type="checkbox"/>		45.0#	\$ 819									
 CRCHR	19-1/2" • C.O.M = .75 yd	CRCHRAU18	<input type="checkbox"/>	<input type="checkbox"/> <input type="checkbox"/> <input type="checkbox"/> <input type="checkbox"/> <input type="checkbox"/>		47.0#	N/A	\$ 1090	\$ 1136	\$ 1163	\$ 1163	\$ 1142	\$ 1195	\$ 1249	\$ 1335	\$ 1393

A **B** **C** **D**

HOW TO ORDER

- Indicate the following information on order form:
- Quantity of each item.
 - Model number, including options. See "How To Build a Model Number".
 - Any special service required.

Note: • The indicates that a choice is required.
• The absence of the indicates that no choice is required.
• Alpha-numeric characters in place of indicate that no other alternatives are available.

HOW TO BUILD A MODEL NUMBER

- A** Select basic model.
- B** Select wood type.

O	- Oak
M	- Maple
- C** Select wood finish. Refer to the **Product Color Options** page in this price list. Stained finish colors; add \$32.
- D** Select upholstery grade and color. Refer to ki.com/fabrics

FINISH INFORMATION

Color Match
KI offers the additional option of color matching paint, polypropylene, or wood stain through Product Modification Requests, contact Customer Service for details.

SPECIAL SERVICES

Special Carton Marking
With specially marked information N/C

Shipping
Ships **assembled, FOB High Point, NC 27263, freight prepaid.** Freight class 125.

Specifications and prices are subject to change without prior notice.



1330 BELLEVUE STREET
GREEN BAY, WI 54302
800.424.2432 / KI.COM

KI is a trusted expert for furniture and wall systems around the globe.
USA | CANADA | MEXICO | UK | EUROPE | ASIA | MIDDLE EAST
© 2023 Krueger International, Inc. All Rights Reserved.