



LEARN2[®] SEATING

PRICE LIST

EFFECTIVE FEBRUARY 25, 2026
800.424.2432



Ordering Customer's Own Material (C.O.M.) Upholstery	
Information	3
Learn2® Classroom Furniture	
General Information	4
Product Color Options	8
Learn2® Classroom Furniture (Freight Excluded)	
Doni® Seating with Worksurface	9
Intellect Wave® Seating with Worksurface	13
LimeLite™ Seating with Worksurface	15
Strive® Seating with Worksurface	17
Doni® Seating without Worksurface	21
Intellect Wave® Seating without Worksurface	25
LimeLite™ Seating without Worksurface	27
Strive® Seating without Worksurface	29
Learn2® Classroom Furniture (Delivered)	
Doni® Seating with Worksurface	33
Intellect Wave® Seating with Worksurface	37
LimeLite™ Seating with Worksurface	39
Strive® Seating with Worksurface	41
Doni® Seating without Worksurface	45
Intellect Wave® Seating without Worksurface	49
LimeLite™ Seating without Worksurface	51
Strive® Seating without Worksurface	53



How to Specify

As a standard procedure, KI applies seating upholstery as swatched by the textile distributor. Reference distributor's website. Upholstery that is required to be applied differently than is swatched, will need a Product Modification Request written specifying the direction the upholstery is to be applied.

Seating upholstery requiring specific positioning of intricate patterns or patterns repeats on seats and backrests, will need a Product Modification Request written including a sketch noting the specific requirements, as in Diagram A.

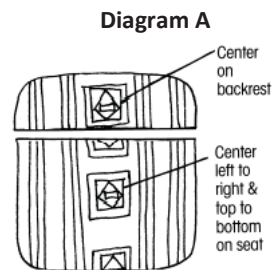

When directional or patterned fabrics are used, they often require more yardage than solid colors.

C.O.M. must be supplied in continuous yardage.

C.O.M. yardage requirements accompanying products in the pricing section are for 10 chairs/seats or less, 54" wide nondirectional material. On larger orders, less material is required.

Leather hides must be a minimum of 50 square feet of usable material. The outer edges cannot be calculated as square feet or yardage. To determine square footage, multiply unit yardage by 18 square feet to obtain the total square footage required per unit.

For exact production yardage requirements, call 1-800-424-2432, ext. 2707.

Production

Customer's upholstery must be approved prior to acceptance for production.

C.O.M. not received into the appropriate facility 3 weeks prior to acknowledged delivery date may go on hold. See KI C.O.M. Shipping Location listing for the correct facility address by product.

Testing

When KI requires testing, actual yardage to upholster one chair may be required. The C.O.M. Specialist will confirm model and fabric testing requirements when applicable.

Approved test samples will be applied to the order or will be held for 6 months. After 6 months, the sample will no longer be applied to your order. For all product testing, send fabric samples to the manufacturing facility. See KI C.O.M. Shipping Location listing for the correct facility address by product.

All C.O.M. must be labeled with the KI product order number and customer purchase order number.

Treated Materials

If C.O.M. requires processing such as a stain resistance treatment or acrylic backing, it may shrink. To prevent delays in delivery or back ordering due to shrinkage, please have your processor verify measurement after processing and assure adequate yardage shipped.

Split Orders

If a portion of the shipment which does not require C.O.M. application is to be processed and shipped early, KI will enter the order immediately at your request. These split shipments are subject to minimum order changes.

Excess Upholstery Material

KI will dispose of excess upholstery material at the time of shipment unless expressly requested to return it with the product shipment.

Cancelled or Changed Orders

KI assumes no responsibility for extra C.O.M. due to a change of upholstery or cancellation of an order. If it the customer's responsibility to arrange for return of the material.

Contact the C.O.M. Specialist at 1-800-424-2432, ext. 2707, with questions or to request a split order.

C.O.M. SHIPPING LOCATION

Architectural Walls Evoke..... MN Genius..... MN Casegoods Aristotle.....MN Likha.....MN Classroom Furniture Cogni GB Intellect Wave GB Learn2.....GB Ruckus..... GB Desking 700 SeriesKP Balance MN Genesis MN True KP Universal MN WorkZone MN Files & Storage 700 Series..... GB ConnectionBW U-Series..... GB Tattoo.....BW Fixed Seating Concerto.....BW Single Pedestal GB Jury Base GB Lancaster.....BW Sequence GB University GB	Panel Systems All Terrain..... KP Balance MN Universal MN Wireworks MN Unite..... MN Residence Hall Furniture RoomScape MN Screens All Terrain..... KP Connection Zone.....BW Tributaire.....BW True/Volition KP Genesis..... KP Tattoo..... MN Universal.....BW Seating 600 Series.....BW Affina HN Altus GB Apply GB Calida HN Cascha VT Civara VT Clamber HN Cogni GB Diem OM Doni GB GladlyVQ Grazie GB Hub HN Impress OM	Impress Ultra OM Intellect Wave GB Jessa HN JubileeVQ Katera..... GB Kurv Benches..... HN Learn2.....GB LimeLite..... GB Lyra HN Medical & Laboratory Stools..... OM MyPlace HN MyWay HN Oath GB Opt4 GB Pilot OM Promenade BW Ruckus..... GB Sela HN Sift GB Signia..... OM Soltice Metal HN Soltice..... HN Sonrisa HN Strive GB Sway BW Tattoo..... HN Torsion-on-the-Go! GB Torsion Air GB Zeker HN Zentori VT Zoetry HN
---	--	--



KI C.O.M. Manufacturing Site Addresses:

BW KI Bonduel Attn: COM Storage 204 West South St. Bonduel, WI 54107	HN KI High Point Attn: COM Storage 217 Feld Avenue High Point, NC 27263	MN KI Manitowoc Attn: COM Storage 1400 S. 41st St. Manitowoc, WI 54220	VQ KI Attn: COM Fabrics 6892 Marlin Circle La Palma, CA 90623
GB KI Green Bay Attn: COM Storage 1687 Westminster Drive - Gate 3 Green Bay, WI 54302	KP KI Pembroke Attn: COM Storage 1000 Olympic Dr. Pembroke, Ontario K8A6X7	OM KI Attn: COM Storage 1110 S. Mildred Ave. Ontario, CA 91761	VT KI Attn: COM Storage 2803 South Taylor Drive Sheboygan, WI 53081



TECHNICAL SPECIFICATIONS

Frame

Frame consists of 14-gauge, 1" diameter steel tubing, bent and welded to a 13-gauge steel stamped seat plate, and finished with baked-on powder-coat paint. The chair frame is topped by two aluminum die castings with a baked-on black powder-coated finish. Castings support the unit's seat and provide a means of rotation of the tablet about the seat.

Shell

Döni®

The backrest and seat are injection-molded polypropylene. The seat and backrest are joined by a pair of hidden articulation mechanisms, each consisting of a 14-gauge steel housing, twin 7-gauge levers and steel coil springs. While maintaining a one-piece shell appearance, this mechanism allows the backrest to recline up to 17 degrees of motion.

Under-seat structure is a die-drawn 12-gauge steel plate. Structure is finished with baked-on electrostatically-applied 30-degree gloss epoxy powder-coat paint.

The Doni shell is designed by Giancarlo Piretti.

Upholstered Seat (optional)

Urethane foam is attached to an injection-molded polypropylene liner board, then upholstered using a draw-string process. Seat foam is molded nominal 1" thickness.

Intellect Wave®

One-piece contoured shell is made of high-impact polypropylene. Colorfastness ensured through complete color impregnation throughout the molded part. Strength and durability is assured through an engineered internal structural cavity which eliminates the need for unsightly ribs on the back of the shell. Shells have rolled edges for comfort and strength, textured front and back, with a wide, ergonomic handle molded into the chair back. Shell fastens to the chair by a 12-gauge formed steel plate with six Torx screws.

Upholstered Seat (optional)

Upholstered chairs have partially exposed polypropylene surfaces. Fabric is upholstered over $\frac{9}{16}$ " foam on the seat and fastened to an inner shell with screws.

LimeLite®

The seat and backrest are integrated into a single shell that is injection-molded in polypropylene, reinforced with glass fiber. The shell is ergonomically contoured and features a passive-flex back movement for superior comfort.

Upholstered Seat (optional)

Molded urethane foam is attached to an injection molded polypropylene seat board, then upholstered using a draw-string process. The assembled seat pad is attached to the seat by means of hidden fasteners. Seat foam is nominal $\frac{1}{4}$ " thickness.

Strive®

Injection molded polypropylene back with integral steel cantilever springs. The combination of the slotted polypropylene back and the spring steel construction provides a supportive flexing back. Springs are nominal 4.5 mm diameter chrome silicon valve spring wire. Injection molded polypropylene seat is secured to the chair by a 12-gauge formed steel plate.

The Strive shell is designed by Giancarlo Piretti.

The chair shell (either option) swivels a total of 55 degrees (27.5 degrees each way from center) for ease of entry and exit.

TECHNICAL SPECIFICATIONS

Upholstered Seat (optional)

Molded urethane foam is attached to an injection molded polypropylene seat board, then upholstered using a draw-string process. The assembled seat pad is attached to the seat by means of hidden fasteners.

Arms (optional)

When equipped with optional cantilever arms, the supporting structure is $\frac{7}{8}$ " diameter by 13-gauge tubular steel, welded directly to the seat support structure, and matching the seat and back color. The armcaps are injection-molded glass filled polypropylene matching the seat and back color. Armcaps are attached to the steel structure by means of screws.

Surface Support

The worksurface is supported from the chair frame by a formed and welded support tube made from $1\frac{1}{8}$ " diameter, 14-gauge steel. The worksurface is supported from the support tube by an aluminum gusset die casting with a black powder-coated paint finish. The support tube rotates around the chair seat a total of 220 degrees (110 degrees each way from front-center). A $\frac{1}{2}$ " thick steel plug is drilled, tapped, and welded into the end of the support tube. The worksurface is structurally secured to the support tube with a Grade 5, $\frac{3}{8}$ -16 bolt, held secure with an epoxy patch.

Surface Mechanism

The gusset die casting rotates about the support tube by means of a plastic bushing connection, rotating a total of 154 degrees around the support tube (77 degrees each way from center). The worksurface slides back and forth for a total of 6" of straight in-and-out movement. The sliding motion is accomplished with an aluminum extruded rail and plastic bushing mechanism.

Surface

The worksurface measures 13" x 21 $\frac{1}{2}$ " for a writing surface area of 280 square inches.

Plastic

The writing surface of the plastic worksurface is injection molded ABS and includes two pencil grooves and a thumb guide. The understructure of the plastic worksurface is injection molded nylon with fiberglass reinforcement filling. Top surface available in Black, Flannel, or Warm Grey; bottom understructure is Black only.

Laminate

The laminate worksurface is 18 mm thick Baltic Birch plywood core with .040" laminate face and .020" paper backing sheet. The edge of the wood surface is shaped and sanded with a sealed and clear coat lacquered finish. KI standard laminates available (see Color Addendum).

Optional Accessory Racks

Accessory Rack (with or without cupholder)

Racks are constructed of 14-gauge perforated steel wrapped with $\frac{1}{4}$ " diameter steel wire and are welded to the frame. Optional cup holders are made of a $\frac{1}{4}$ " diameter steel wire, welded with an 11-gauge flat metal round trim plate to the steel racks. Accessory racks (with or without cupholder) are not field installable or retrofittable.

Flat Accessory Rack

Rack is constructed of 16-gauge perforated steel wrapped with $\frac{1}{4}$ " diameter steel wire welded to the frame. The rack is reinforced with stiffener channels that are constructed of 14-gauge cold rolled steel that are welded to the perforated steel rack assembly. The rack is fastened to weldments on the chair frame using #10-24 x $\frac{1}{2}$ " PEM self-clinching studs, #10-24 hex nuts and lock washers. The flat accessory rack is not field installable or retrofittable.

Poly Bookbag Rack

Rack is constructed of injection molded polypropylene and has a textured finish. It fastens to the chair using four #12 x $\frac{3}{8}$ " Truss head screws and has a molded-in cupholder and two accessory slots.

Castors and Glides

Castors are double wheels (60 mm) of high-impact thermoplastic with high impact plastic frame. Carpet or hard floor casters, Black only.

Optional Bell glides (2" high) made of high-impact plastic also available, Black only.



DIMENSIONS

Doni® Seating

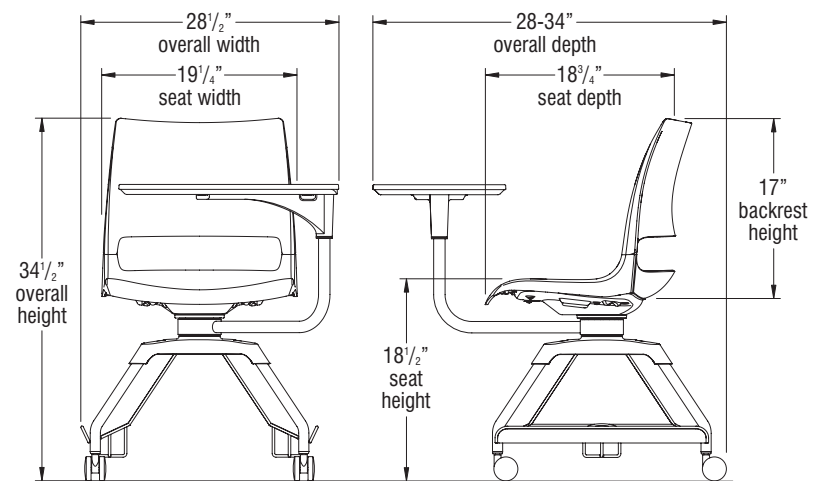

Intellect Wave® Seating

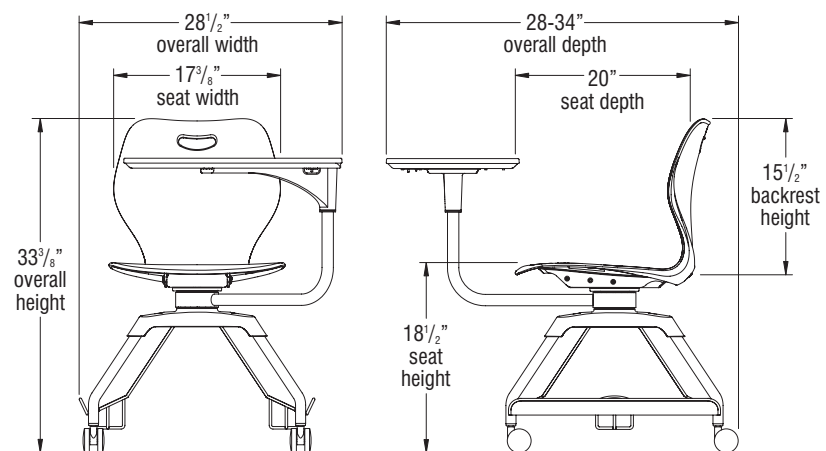

LimeLite® Seating

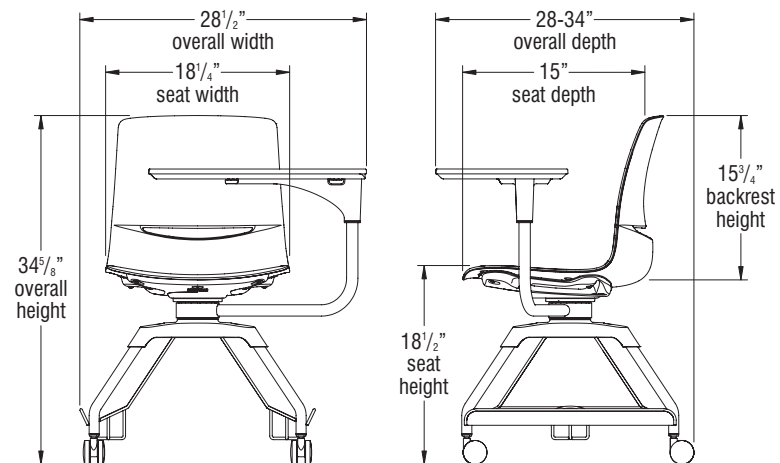

DIMENSIONS

Strive® Seating

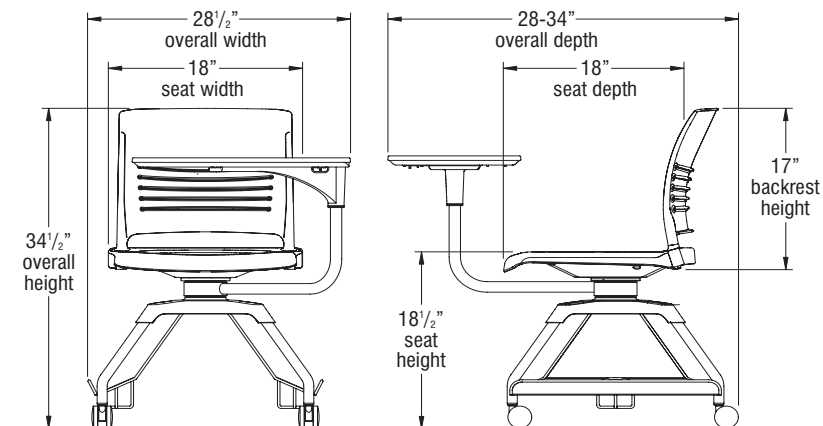

Learn2® Seating Tablet Arm

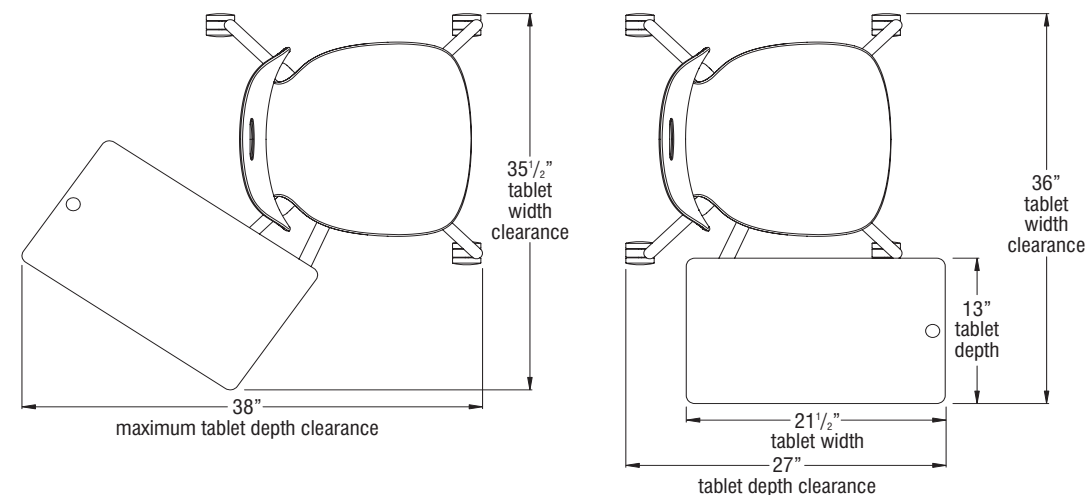
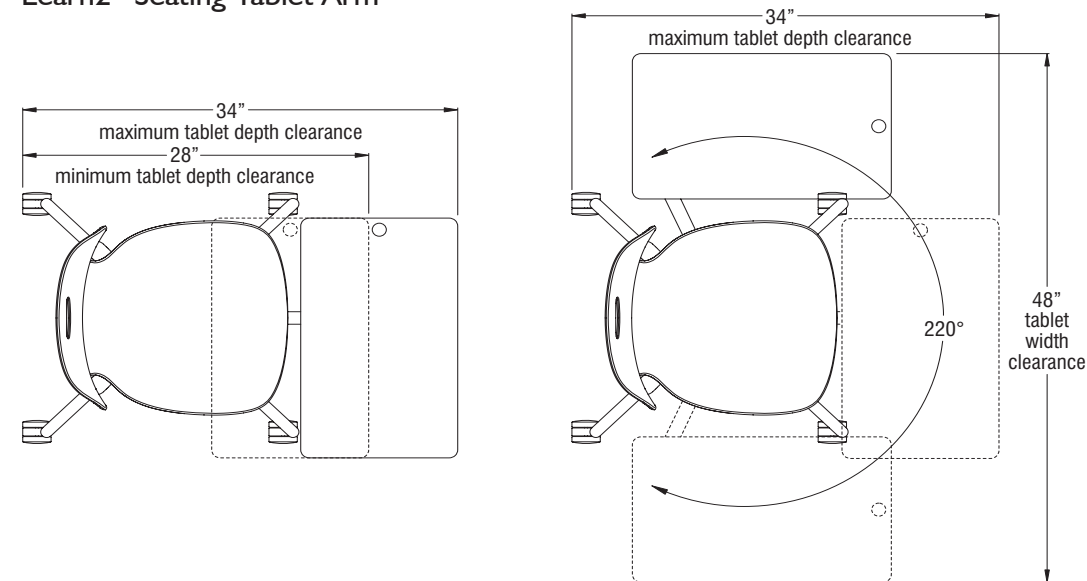



DIMENSIONS

Learn2® Seating Tablet Arm

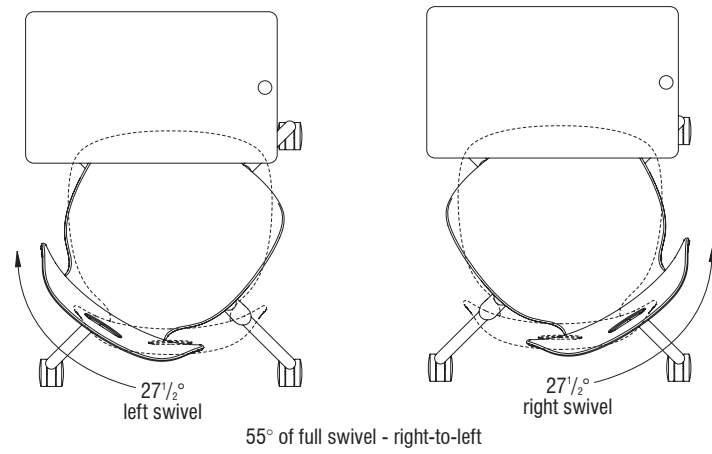

STATEMENT OF LINE

Doni® Seating

All models are available in polypropylene seat/backrest, upholstered seat/ polypropylene backrest, or upholstered seat/backrest.

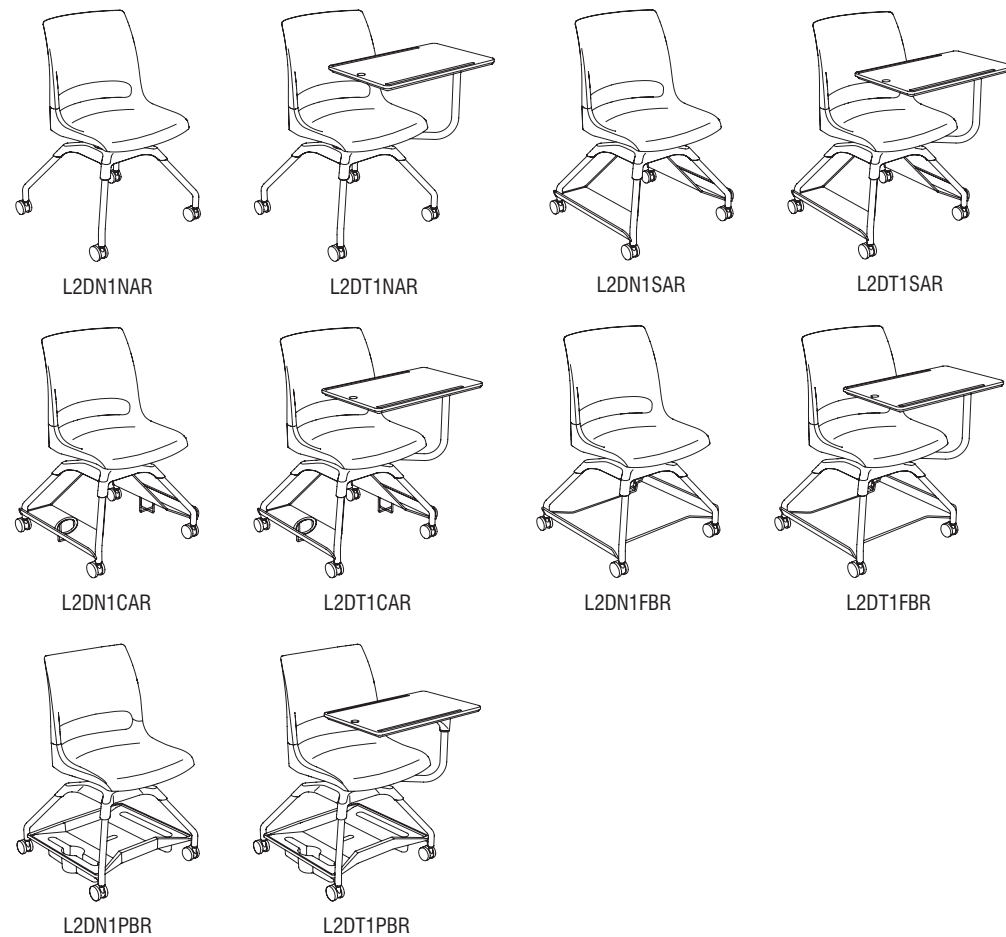

STATEMENT OF LINE

Intellect Wave® Seating

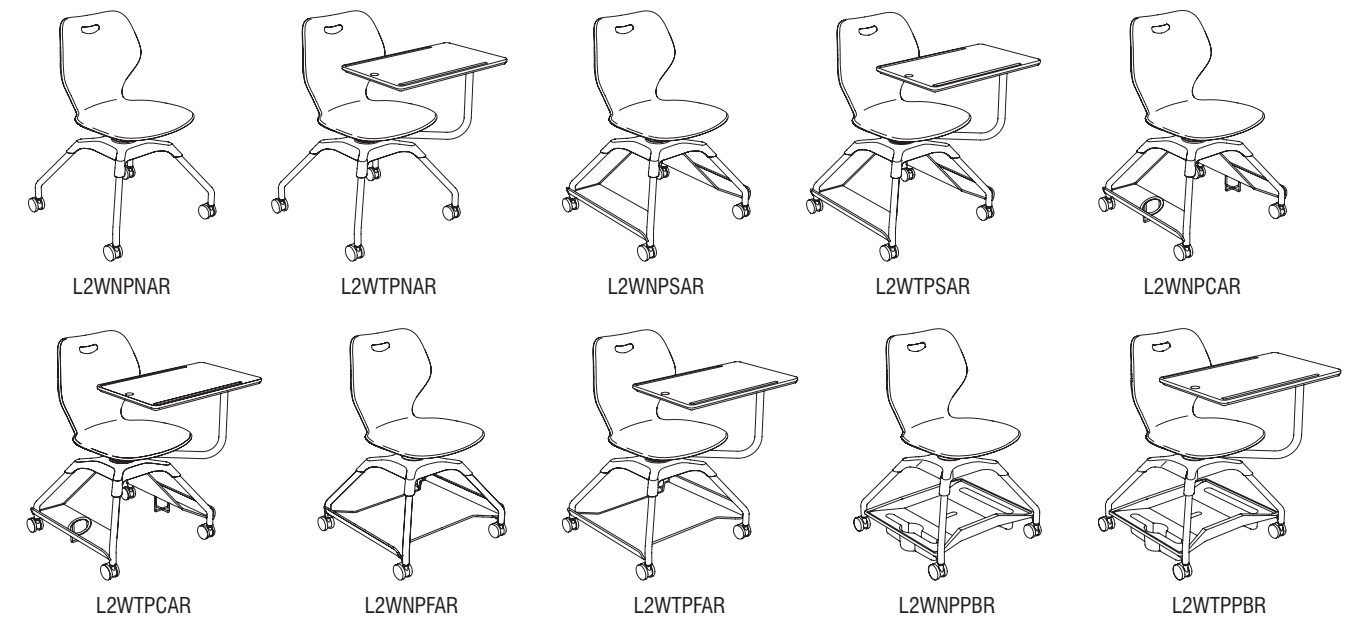

Limelite® Seating

All models are available in polypropylene seat/backrest, upholstered seat/ polypropylene backrest, or upholstered seat/backrest

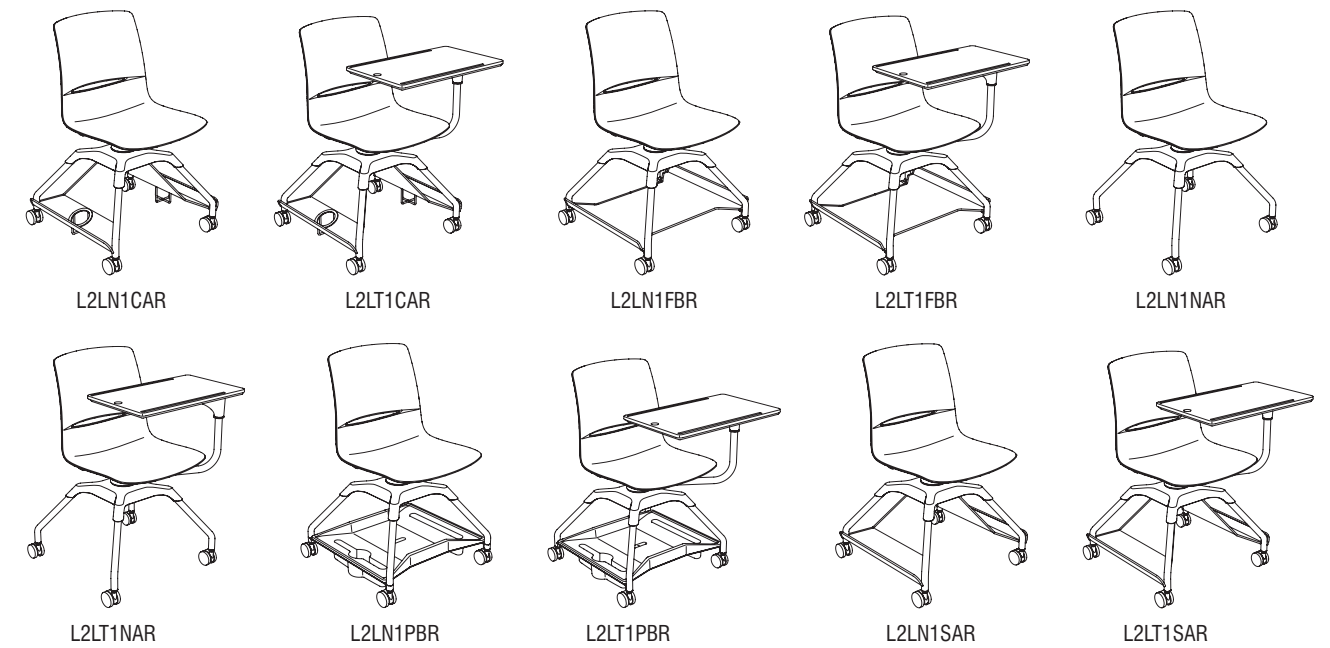

STATEMENT OF LINE

Strive® Seating

All models are available in polypropylene seat/backrest, upholstered seat/ polypropylene backrest, or upholstered seat/backrest.

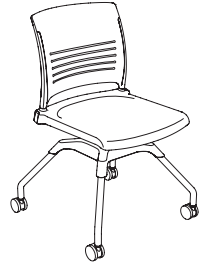

L2SNPNANAR



L2STPNANAR



L2SNPCANAR

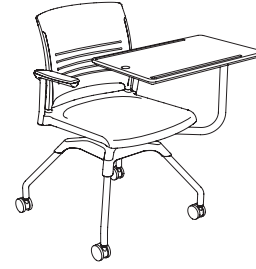

L2STPCANAR



L2SNPNASAR



L2STPNASAR



L2SNPCASAR



L2STPCASAR



L2SNPNACAR

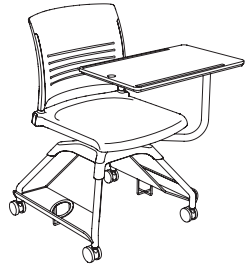

L2STPNACAR



L2SNPCACAR



L2STPCACAR



L2SNPNAFAR



L2STPNAFAR



L2SNPCAFAR



L2STPCAFAR



L2SNPNAPBR



L2STPNAPBR



L2SNPNAPBR



L2STPCAPBR



Learn2®		Crisp Linen	LRI	Surf's Up	PSP	Outside Twilight Shadow/Inside Warm Grey	OTI/IWG
Frame Color		Designer White	LDR	Tarragon	PTQ	Outside Ultra Blue/inside Cottonwood	OUB/ICO
Black	BL	Dove Grey	LDG	Twilight Shadow	PTI	Outside Ultra Blue/Inside Warm Grey	OUB/IWG
Blue Grey	GR	Florence Walnut	LFC	Ultra Blue	PUB	Outside Warm Grey/Inside Cottonwood	OWG/ICO
Bronze Metallic	ZM	Friston Ash	LFH	Warm Grey	PWG	Outside Zesty Lime/inside Cottonwood	OZL/ICO
Cayenne	CY	Frosty White	LFW	Zesty Lime	PZL		
Champagne Metallic	CM	Graphite Nebula	LGN				
Cool Grey	CG	Grey	LGE				
Cottonwood	CO	High Rise	LHE				
Earthen Clay	EY	Hollyberry	LHY				
Espresso Metallic	EX	Island	LID				
Everglade Shade	EV	Italian Silver Ash	LIT				
Flannel	FN	Kensington Maple	LKM				
Glitz Metallic	GZ	Lapis Blue	LLB				
Hazy Jade	HJ	Monticello Maple	LMT				
Honey Bee	HY	North Sea	LNA				
Light Tone	LG	Ocean	LON				
Mardi Gras	MG	Pinnacle Walnut	LPW				
Misty Brown	MY	River Cherry	LRY				
Nemo	NE	Shadow Zephyr	LSR				
Nordic	ND	Sterling Ash	LAZ				
Poppy Red	PR	Titanium Evolv	LTV				
Purple Haze	PH	White Nebula	LWL				
Rainforest	RQ	White Sand	LWN				
Raw Jasper	RJ	Windsor Mahogany	LWY				
Rubber Ducky	RK						
Sand	SA						
Sky Blue	SK						
Starlight Silver Metallic	SX						
Surf's Up	SP						
Tarragon	TQ						
Twilight Shadow	TI						
Ultra Blue	UB						
Warm Grey	WG						
Zesty Lime	ZL						

Surface Finish--Grade 2 Standard Laminate

Akira	LAK
Black Alicante	LBY
Black Hills Oak	LBH
Calcutta Marble	LCQ
Dering Forest	LDG
Fawn Cypress	LFQ
Ice Mist	LIM
Markerboard White	LMK
Valley Forge Elm	LVF
White River Forest	LWR

Learn2 - Doni**SOLID COLOR Seat and Back - Polypropylene**

Black	PBL
Blue Grey	PGR
Cayenne	PCY
Cool Grey	PCG
Cottonwood	PCO
Earthen Clay	PEY
Everglade Shade	PEV
Flannel	PFN
Hazy Jade	PHJ
Honey Bee	PHY
Light Tone	PLG
Misty Brown	PMY
Nemo	PNE
Nordic	PND
Purple Haze	PPH
Rainforest	PRQ
Raw Jasper	PRJ

TWO-TONE COLOR Seat and Back - Polypropylene**Outside / Inside**

Outside Black/Inside Cool Grey	OBL/ICG
Outside Black/inside Cottonwood	OBL/ICO
Outside Black/Inside Light Tone	OBL/ILG
Outside Black/Inside Warm Grey	OBL/IWG
Outside Blue Grey/inside Cool Grey	OGR/ICG
Outside Blue Grey/inside Cottonwood	OGR/ICO
Outside Cayenne/Inside Cool Grey	OCY/ICG
Outside Cayenne/Inside Cottonwood	OCY/ICO
Outside Cayenne/Inside Light Tone	OCY/ILG
Outside Cayenne/Inside Warm Grey	OCY/IWG
Outside Cool Grey/inside Cottonwood	OCG/ICO
Outside Everglade Shade/Inside Cool Grey	OEV/ICG
Outside Everglade Shade/Inside Cottonwood	OEV/ICO
Outside Everglade Shade/Inside Light Tone	OEV/ILG
Outside Everglade Shade/Inside Warm Grey	OEV/IWG
Outside Flannel/Inside Cool Grey	OFN/ICG
Outside Flannel/Inside Cottonwood	OFN/ICO
Outside Flannel/Inside Light Tone	OFN/ILG
Outside Flannel/inside Warm Grey	OFN/IWG
Outside Misty Brown/inside Cottonwood	OMY/ICO
Outside Misty Brown/Inside Light Tone	OMY/ILG
Outside Nordic/inside Cool Grey	OND/ICG
Outside Nordic/Inside Cottonwood	OND/ICO
Outside Nordic/Inside Light Tone	OND/ILG
Outside Nordic/Inside Warm Grey	OND/IWG
Outside Purple Haze/Inside Cool Grey	OPH/ICG
Outside Purple Haze/Inside Cottonwood	OPH/ICO
Outside Purple Haze/Inside Light Tone	OPH/ILG
Outside Purple Haze/Inside Warm Grey	OPH/IWG
Outside Rainforest/Inside Cool Grey	ORQ/ICG
Outside Rainforest/Inside Cottonwood	ORQ/ICO
Outside Rainforest/Inside Light Tone	ORQ/ILG
Outside Rainforest/Inside Warm Grey	ORQ/IWG
Outside Raw Jasper/Inside Cool Grey	ORJ/ICG
Outside Raw Jasper/Inside Cottonwood	ORJ/ICO
Outside Raw Jasper/Inside Light Tone	ORJ/ILG
Outside Raw Jasper/Inside Warm Grey	ORJ/IWG
Outside Surf's Up/inside Cool Grey	OSP/ICG
Outside Surfs Up/Inside Cottonwood	OSP/ICO
Outside Surfs Up/Inside Light Tone	OSP/ILG
Outside Surfs Up/Inside Warm Grey	OSP/IWG
Outside Tarragon/Inside Cool Grey	OTQ/ICG
Outside Tarragon/Inside Cottonwood	OTQ/ICO
Outside Tarragon/Inside Light Tone	OTQ/ILG
Outside Tarragon/Inside Warm Grey	OTQ/IWG
Outside Twilight Shadow/Inside Cool Grey	OTI/ICG
Outside Twilight Shadow/Inside Cottonwood	OTI/ICO
Outside Twilight Shadow/Inside Light Tone	OTI/ILG

Learn2® - Intellect Wave®, LimeLite™ and Strive®**Seat and Back Color - Poly for Upholstered and Non-Upholstered**

Black	PBL
Blue Grey	PGR
Cayenne	PCY
Cool Grey	PCG
Cottonwood	PCO
Earthen Clay	PEY
Everglade Shade	PEV
Flannel	PFN
Hazy Jade	PHJ
Honey Bee	PHY
Light Tone	PLG
Mardi Gras	PMG
Misty Brown	PMY
Nemo	PNE
Nordic	PND
Poppy Red	PPR
Purple Haze	PPH
Rainforest	PRQ
Raw Jasper	PRJ
Rubber Ducky	PRK
Sand	PSA
Sky Blue	PSK
Surf's Up	PSP
Tarragon	PTQ
Twilight Shadow	PTI
Ultra Blue	PUB
Warm Grey	PWG
Zesty Lime	PZL

Additional colors may be available. Please contact KI customer service at 1-800-424-2432.

Surface Color - Plastic Colors

Black	BLWS
Warm Grey	WGWS
Flannel	FNWS

Additional colors may be available. Please contact KI customer service at 1-800-424-2432.

Surface Finish--Grade 1 Standard Laminate

Beigewood	LBZ
Belair	LBQ
Biltmore Cherry	LBT
Black	LBK
Brighton Walnut	LBW
Castle Oak	LCO
Cherry Storm	LCX
Classic Linen	LCI
Cocobala	LCC

Finish Cards

View color swatches for items listed within this document.

Paints**Plastics/Poly****Wood/Veneer****Laminates****Molded Edges****Edge Styles****Hard Plastics****Glass**

Certain options referenced may not be available on GSA Schedule.



Learn2® Classroom Furniture (Freight Excluded)

Doni® Seating with Worksurface



Learn2® Classroom Furniture (Freight Excluded)

Doni® Seating with Worksurface

Features	MODEL NUMBER									Approx. Packaged Weight	Freight Excluded Pricing Unupholstered	Freight Excluded Pricing Fabric Grade 1, C.O.M. & COV	Freight Excluded Pricing Fabric Grade 2	Freight Excluded Pricing Fabric Grade 3 & Group 2V Vinyl	Freight Excluded Pricing Pallas Fabric Group P0	Freight Excluded Pricing Pallas Fabric Group P1	Freight Excluded Pricing Pallas Fabric Group P2	Freight Excluded Pricing Pallas Fabric Group P3	Freight Excluded Pricing Pallas Fabric Group P4	Laminate Grade 2 add to list price		
	Basic Model	Surface Type	Frame Color	Poly Solid Color	Poly Outside/Inside Color	Surface Finish/Plastic Color	Glide Option	Uph. Color														
 <p>2DWS1 2DWS2 2DWSA 2DWSB</p> <p>Without Accessory Rack</p> <ul style="list-style-type: none"> • Non-handed worksurface in choice of plastic or laminate • Solid or two-tone colored shell • Unlimited color match's • 17 degrees of hip articulation 	Solid Color, Polypropylene	L2DT1/NAR	<input type="checkbox"/>	<input type="checkbox"/>	<input type="checkbox"/>		<input type="checkbox"/>	<input type="checkbox"/>		57.00#	\$ 885										\$ 19	
	Solid Color, Upholstered Seat	L2DT2/NAR	<input type="checkbox"/>	<input type="checkbox"/>	<input type="checkbox"/>		<input type="checkbox"/>	<input type="checkbox"/>	<input type="checkbox"/>	57.00#	N/A	1031	1044	1063	1075	1126	1144	1170	1206		19	
	Two-Tone, Polypropylene	L2DTA/NAR	<input type="checkbox"/>	<input type="checkbox"/>		<input type="checkbox"/>	<input type="checkbox"/>	<input type="checkbox"/>		57.00#	955											19
	Two-Tone, Upholstered Seat	L2DTB/NAR	<input type="checkbox"/>	<input type="checkbox"/>		<input type="checkbox"/>	<input type="checkbox"/>	<input type="checkbox"/>	<input type="checkbox"/>	57.00#	N/A	1103	1111	1134	1144	1194	1214	1238	1274		19	
 <p>2DWS1 2DWS2 2DWSA 2DWSB</p> <p>Accessory Rack</p> <ul style="list-style-type: none"> • Non-handed worksurface in choice of plastic or laminate • Accessory rack included on both sides of frame • Solid or two-tone colored shell • Unlimited color match's • 17 degrees of hip articulation 	Solid Color, Polypropylene	L2DT1/SAR	<input type="checkbox"/>	<input type="checkbox"/>	<input type="checkbox"/>		<input type="checkbox"/>	<input type="checkbox"/>		57.00#	\$ 914										\$ 19	
	Solid Color, Upholstered Seat	L2DT2/SAR	<input type="checkbox"/>	<input type="checkbox"/>	<input type="checkbox"/>		<input type="checkbox"/>	<input type="checkbox"/>	<input type="checkbox"/>	57.00#	N/A	1061	1073	1093	1104	1154	1173	1199	1235		19	
	Two-Tone, Polypropylene	L2DTA/SAR	<input type="checkbox"/>	<input type="checkbox"/>		<input type="checkbox"/>	<input type="checkbox"/>	<input type="checkbox"/>		57.00#	983											19
	Two-Tone, Upholstered Seat	L2DTB/SAR	<input type="checkbox"/>	<input type="checkbox"/>		<input type="checkbox"/>	<input type="checkbox"/>	<input type="checkbox"/>	<input type="checkbox"/>	57.00#	N/A	1130	1142	1163	1173	1223	1244	1268	1303		19	

HOW TO ORDER

- Indicate the following information on order form:
- Quantity of each item.
 - Model number, including options. See "How To Build a Model Number".
 - Any special service required.

Note: • The indicates that a choice is required.
 • The absence of the indicates that no choice is required.
 • Alpha-numeric characters in place of indicate that no other alternatives are available.

HOW TO BUILD A MODEL NUMBER

- A** Select basic model.
- B** Select worksurface type.
 LW - Laminate worksurface; add \$63
 PW - Plastic worksurface
- C** Select frame color.
- D** Select solid poly color.
- E** Select outside/inside poly color.
- F** Select surface finish.
- G** Select caster/glide option.

- C** - Carpet casters
- S** - Hard floor casters
- GL** - Glides
- SCG** - Front hard floor casters, rear glides
- CCG** - Front carpet casters, rear glides

H Select upholstery grade/color. Refer to ki.com/fabrics

UPHOLSTERY INFORMATION

C.O.M. Upholstery
 C.O.M. requirement for 10 chairs or less with upholstered seat or upholstered seat and back is 3/4 yard per chair of 54" wide nondirectional fabric. For orders of 11 or more with upholstered seat and back and for complete information on ordering C.O.M. see "Ordering C.O.M., C.O.V. and C.O.L." section.

SPECIAL SERVICES

Special Carton Marking
 With specially marked information N/C

Shipping
 Ships assembled, FOB Green Bay, WI 54302, freight excluded. Freight class 300.

Specifications and prices are subject to change without prior notice.

Learn2® Classroom Furniture (Freight Excluded)

Doni® Seating with Worksurface



Learn2® Classroom Furniture (Freight Excluded)

Doni® Seating with Worksurface

Features	MODEL NUMBER								Approx. Packaged Weight	Freight Excluded Pricing Unupholstered	Freight Excluded Pricing Fabric Grade 1, C.O.M. & COV	Freight Excluded Pricing Fabric Grade 2	Freight Excluded Pricing Fabric Grade 3 & Group 2V Vinyl	Freight Excluded Pricing Pallas Fabric Group P0	Freight Excluded Pricing Pallas Fabric Group P1	Freight Excluded Pricing Pallas Fabric Group P2	Freight Excluded Pricing Pallas Fabric Group P3	Freight Excluded Pricing Pallas Fabric Group P4	Laminate Grade 2 add to list price
	Basic Model	Surface Type	Frame Color	Poly Solid Color	Poly Outside/Inside Color	Surface Finish/Plastic Color	Glide Option	Uph. Color											
Solid Color, Polypropylene	L2DT1/CAR	<input type="checkbox"/>	<input type="checkbox"/>	<input type="checkbox"/>		<input type="checkbox"/>	<input type="checkbox"/>		57.00#	\$ 962									\$ 19
Solid Color, Upholstered Seat	L2DT2/CAR	<input type="checkbox"/>	<input type="checkbox"/>	<input type="checkbox"/>		<input type="checkbox"/>	<input type="checkbox"/>	<input type="checkbox"/>	57.00#	N/A	1107	1120	1140	1150	1201	1220	1246	1282	19
Two-Tone, Polypropylene	L2DTA/CAR	<input type="checkbox"/>	<input type="checkbox"/>		<input type="checkbox"/>	<input type="checkbox"/>	<input type="checkbox"/>		57.00#	1030									19
Two-Tone, Upholstered Seat	L2DTB/CAR	<input type="checkbox"/>	<input type="checkbox"/>		<input type="checkbox"/>	<input type="checkbox"/>	<input type="checkbox"/>	<input type="checkbox"/>	57.00#	N/A	1176	1190	1209	1220	1271	1291	1315	1349	19
2DWS1																			
2DWS2																			
2DWSA																			
2DWSB																			
Cup Holder/Accessory Rack																			
• Non-handed worksurface in choice of plastic or laminate																			
• Cup holder/accessory rack included on both sides of frame																			
• Solid or two-tone colored shell																			
• Unlimited color match's																			
• 17 degrees of hip articulation																			
	A	B	C	D	E	F	G	H											



- 2DWS1
- 2DWS2
- 2DWSA
- 2DWSB
- Cup Holder/Accessory Rack**
- Non-handed worksurface in choice of plastic or laminate
- Cup holder/accessory rack included on both sides of frame
- Solid or two-tone colored shell
- Unlimited color match's
- 17 degrees of hip articulation

HOW TO ORDER

- Indicate the following information on order form:
- Quantity of each item.
 - Model number, including options. See "How To Build a Model Number".
 - Any special service required.

- Note:
- The indicates that a choice is required.
 - The absence of the indicates that no choice is required.
 - Alpha-numeric characters in place of indicate that no other alternatives are available.

HOW TO BUILD A MODEL NUMBER

- A**Select basic model.
- B**Select worksurface type.
 - LW** - Laminate worksurface; add \$63
 - PW** - Plastic worksurface
- C**Select frame color. Refer to the **Product Color Options** page in this price list.
- D**Select solid poly color. Refer to the **Product Color Options** page in this price list.
- E**Select outside/inside poly color. Refer to the **Product Color Options** page in this price list.
- F**Select surface finish. Refer to the **Product Color Options** page in this price list.
- G**Select caster/glide option.

C	- Carpet casters
S	- Hard floor casters
GL	- Glides
SCG	- Front hard floor casters, rear glides
CCG	- Front carpet casters, rear glides

- H**Select upholstery grade/color. Refer to ki.com/fabrics

UPHOLSTERY INFORMATION

C.O.M. Upholstery
 C.O.M. requirement for 10 chairs or less with upholstered seat or upholstered seat and back is 3/4 yard per chair of 54" wide nondirectional fabric. For orders of 11 or more with upholstered seat and back and for complete information on ordering C.O.M. see "Ordering C.O.M., C.O.V. and C.O.L." section.

SPECIAL SERVICES

Special Carton Marking

With specially marked information N/C

Shipping

Ships assembled, FOB Green Bay, WI 54302, freight excluded. Freight class 300.

Specifications and prices are subject to change without prior notice.

Learn2® Classroom Furniture (Freight Excluded)

Doni® Seating with Worksurface



Learn2® Classroom Furniture (Freight Excluded)

Doni® Seating with Worksurface

Features	MODEL NUMBER								Approx. Packaged Weight	Freight Excluded Pricing Unupholstered	Freight Excluded Pricing Fabric Grade 1, C.O.M. & COV	Freight Excluded Pricing Fabric Grade 2	Freight Excluded Pricing Fabric Grade 3 & Group 2V Vinyl	Freight Excluded Pricing Pallas Fabric Group P0	Freight Excluded Pricing Pallas Fabric Group P1	Freight Excluded Pricing Pallas Fabric Group P2	Freight Excluded Pricing Pallas Fabric Group P3	Freight Excluded Pricing Pallas Fabric Group P4	Laminate Grade 2 add to list price
	Basic Model	Surface Type	Frame Color	Poly Solid Color	Poly Outside/Inside Color	Surface Finish/Plastic Color	Glide Option	Uph. Color											
Solid Color, Polypropylene	L2DT1/FBR	<input type="checkbox"/>	<input type="checkbox"/>	<input type="checkbox"/>		<input type="checkbox"/>	<input type="checkbox"/>		57.00#	\$ 962									\$ 19
Solid Color, Upholstered Seat	L2DT2/FBR	<input type="checkbox"/>	<input type="checkbox"/>	<input type="checkbox"/>		<input type="checkbox"/>	<input type="checkbox"/>	<input type="checkbox"/>	57.00#	N/A	1107	1120	1140	1150	1201	1220	1246	1282	19
Two-Tone, Polypropylene	L2DTA/FBR	<input type="checkbox"/>	<input type="checkbox"/>		<input type="checkbox"/>	<input type="checkbox"/>	<input type="checkbox"/>		57.00#	1030									19
Two-Tone, Upholstered Seat	L2DTB/FBR	<input type="checkbox"/>	<input type="checkbox"/>		<input type="checkbox"/>	<input type="checkbox"/>	<input type="checkbox"/>	<input type="checkbox"/>	57.00#	N/A	1176	1190	1209	1220	1271	1291	1315	1349	19
2DWS1																			
2DWS2																			
2DWSA																			
2DWSB																			
Flat Accessory Rack																			
• Non-handed worksurface in choice of plastic or laminate																			
• Flat accessory rack included																			
• Solid or two-tone colored shell																			
• Unlimited color match's																			
• 17 degrees of hip articulation																			
	A	B	C	D	E	F	G	H											



2DWS1
2DWS2
2DWSA
2DWSB

- Flat Accessory Rack**
- Non-handed worksurface in choice of plastic or laminate
 - Flat accessory rack included
 - Solid or two-tone colored shell
 - Unlimited color match's
 - 17 degrees of hip articulation

HOW TO ORDER

- Indicate the following information on order form:
1. Quantity of each item.
 2. Model number, including options. See "How To Build a Model Number".
 3. Any special service required.

- Note:
- The indicates that a choice is required.
 - The absence of the indicates that no choice is required.
 - Alpha-numeric characters in place of indicate that no other alternatives are available.

HOW TO BUILD A MODEL NUMBER

- A** Select basic model.
- B** Select worksurface type.
 - LW** - Laminate worksurface; add \$63
 - PW** - Plastic worksurface
- C** Select frame color. Refer to the **Product Color Options** page in this price list.
- D** Select solid poly color. Refer to the **Product Color Options** page in this price list.
- E** Select outside/inside poly color. Refer to the **Product Color Options** page in this price list.
- F** Select surface finish. Refer to the **Product Color Options** page in this price list.
- G** Select caster/glide option.

- C** - Carpet casters
 - S** - Hard floor casters
 - GL** - Glides
 - SCG** - Front hard floor casters, rear glides
 - CCG** - Front carpet casters, rear glides
- H** Select upholstery grade/color. Refer to ki.com/fabrics

UPHOLSTERY INFORMATION

C.O.M. Upholstery
C.O.M. requirement for 10 chairs or less with upholstered seat or upholstered seat and back is 3/4 yard per chair of 54" wide nondirectional fabric. For orders of 11 or more with upholstered seat and back and for complete information on ordering C.O.M. see "Ordering C.O.M., C.O.V. and C.O.L." section.

SPECIAL SERVICES

Special Carton Marking

With specially marked information N/C

Shipping

Ships assembled, FOB Green Bay, WI 54302, freight excluded. Freight class 300.

Specifications and prices are subject to change without prior notice.



Learn2® Classroom Furniture (Freight Excluded)

Intellect Wave® Seating with Worksurface



Learn2® Classroom Furniture (Freight Excluded)

Intellect Wave® Seating with Worksurface

MODEL	Features	MODEL NUMBER							Approx. Packaged Weight	Freight Excluded Pricing	Freight Excluded Pricing Fabric Grade 1, C.O.M. & COV	Freight Excluded Pricing Fabric Grade 2	Freight Excluded Pricing Fabric Grade 3 & Group 2V Vinyl	Freight Excluded Pricing Pallas Fabric Group P0	Freight Excluded Pricing Pallas Fabric Group P1	Freight Excluded Pricing Pallas Fabric Group P2	Freight Excluded Pricing Pallas Fabric Group P3	Freight Excluded Pricing Pallas Fabric Group P4	Laminate Grade 2 add to list price
		Basic Model	Surface Type	Frame Color	Shell Color	Surface Finish/Plastic Color	Glide Option	Uph. Color											
 2WWSP 2WWSU	Without Accessory Rack • Non-handed worksurface in choice of plastic or laminate	Polypropylene	L2WTP/NAR	<input type="checkbox"/>	<input type="checkbox"/>	<input type="checkbox"/>	<input type="checkbox"/>	<input type="checkbox"/>	37.00#	\$ 683									\$ 19
		Upholstered Seat	L2WTUS/NAR	<input type="checkbox"/>	<input type="checkbox"/>	<input type="checkbox"/>	<input type="checkbox"/>	<input type="checkbox"/>	<input type="checkbox"/>	40.00#	N/A	749	754	767	754	802	818	839	855
 2WWSP 2WWSU	Accessory Rack • Non-handed worksurface in choice of plastic or laminate • Accessory rack included on both sides of frame	Polypropylene	L2WTP/SAR	<input type="checkbox"/>	<input type="checkbox"/>	<input type="checkbox"/>	<input type="checkbox"/>	<input type="checkbox"/>	46.00#	\$ 708									\$ 19
		Upholstered Seat	L2WTUS/SAR	<input type="checkbox"/>	<input type="checkbox"/>	<input type="checkbox"/>	<input type="checkbox"/>	<input type="checkbox"/>	<input type="checkbox"/>	49.00#	N/A	777	781	793	781	830	845	867	881
 2WWSP 2WWSU	Cup Holder/Accessory Rack • Non-handed worksurface in choice of plastic or laminate • Cup holder/accessory rack included on both sides of frame	Polypropylene	L2WTP/CAR	<input type="checkbox"/>	<input type="checkbox"/>	<input type="checkbox"/>	<input type="checkbox"/>	<input type="checkbox"/>	46.00#	\$ 753									\$ 19
		Upholstered Seat	L2WTUS/CAR	<input type="checkbox"/>	<input type="checkbox"/>	<input type="checkbox"/>	<input type="checkbox"/>	<input type="checkbox"/>	<input type="checkbox"/>	49.00#	N/A	821	825	838	825	874	889	909	925

A **B** **C** **D** **E** **F** **G**

HOW TO ORDER

- Indicate the following information on order form:
- Quantity of each item.
 - Model number, including options. See "How To Build a Model Number".
 - Any special service required.

Note: • The indicates that a choice is required.
 • The absence of the indicates that no choice is required.
 • Alpha-numeric characters in place of indicate that no other alternatives are available.

HOW TO BUILD A MODEL NUMBER

- A** Select basic model.
- B** Select worksurface type.
 - LW** - Laminate worksurface; add \$63
 - PW** - Plastic worksurface
- C** Select frame color. Refer to the **Product Color Options** page in this price list.
- D** Select shell color. Refer to the **Product Color Options** page in this price list.
- E** Select surface finish. Refer to the **Product Color Options** page in this price list.
- F** Select caster/glide option.
 - C** - Carpet casters
 - S** - Hard floor casters
 - GL** - Glides
 - SCG** - Front hard floor casters, rear

glides
CCG - Front carpet casters, rear glides
G Select upholstery grade/color. Refer to ki.com/fabrics

UPHOLSTERY INFORMATION

C.O.M. Upholstery
 C.O.M. requirement is 5/8 yard per chair for seat of 54" wide nondirectional fabric. For complete information on ordering C.O.M. see "Ordering C.O.M., C.O.V. and C.O.L." section.

SPECIAL SERVICES

Special Carton Marking
 With specially marked information N/C

Shipping
 Ships assembled, FOB Green Bay, WI 54302, freight excluded. Freight class 300.

Specifications and prices are subject to change without prior notice.



Learn2® Classroom Furniture (Freight Excluded)

Intellect Wave® Seating with Worksurface



Learn2® Classroom Furniture (Freight Excluded)

Intellect Wave® Seating with Worksurface

MODEL	Features	MODEL NUMBER							Approx. Packaged Weight	Freight Excluded Pricing	Freight Excluded Pricing Fabric Grade 1, C.O.M. & COV	Freight Excluded Pricing Fabric Grade 2	Freight Excluded Pricing Fabric Grade 3 & Group 2V Vinyl	Freight Excluded Pricing Pallas Fabric Group P0	Freight Excluded Pricing Pallas Fabric Group P1	Freight Excluded Pricing Pallas Fabric Group P2	Freight Excluded Pricing Pallas Fabric Group P3	Freight Excluded Pricing Pallas Fabric Group P4	Laminate Grade 2 add to list price
		Basic Model	Surface Type	Frame Color	Shell Color	Surface Finish/Plastic Color	Glide Option	Uph. Color											
 2WWSP 2WWSU	Poly Bookbag Rack • Non-handed worksurface in choice of plastic or laminate • Poly bookbag rack included • Poly bookbag rack includes two accessory slots and a cupholder • Poly Bookbag rack is only available in black	Polypropylene	L2WTP/PBR	<input type="checkbox"/>	<input type="checkbox"/>	<input type="checkbox"/>	<input type="checkbox"/>	<input type="checkbox"/>	46.00#	\$ 775									\$ 19
		Upholstered Seat	L2WTUS/PBR	<input type="checkbox"/>	<input type="checkbox"/>	<input type="checkbox"/>	<input type="checkbox"/>	<input type="checkbox"/>	<input type="checkbox"/>	49.00#	N/A	845	853	864	853	902	920	941	957
 2WWSP 2WWSU	Flat Accessory Rack • Non-handed worksurface in choice of plastic or laminate • Flat accessory rack included	Polypropylene	L2WTP/FBR	<input type="checkbox"/>	<input type="checkbox"/>	<input type="checkbox"/>	<input type="checkbox"/>	<input type="checkbox"/>	46.00#	\$ 753									\$ 19
		Upholstered Seat	L2WTUS/FBR	<input type="checkbox"/>	<input type="checkbox"/>	<input type="checkbox"/>	<input type="checkbox"/>	<input type="checkbox"/>	<input type="checkbox"/>	49.00#	N/A	821	825	838	825	874	889	909	925

A **B** **C** **D** **E** **F** **G**

HOW TO ORDER

- Indicate the following information on order form:
- Quantity of each item.
 - Model number, including options. See "How To Build a Model Number".
 - Any special service required.

Note: • The indicates that a choice is required.
 • The absence of the indicates that no choice is required.
 • Alpha-numeric characters in place of indicate that no other alternatives are available.

HOW TO BUILD A MODEL NUMBER

- A** Select basic model.
- B** Select worksurface type.
 - LW** - Laminate worksurface; add \$63
 - PW** - Plastic worksurface
- C** Select frame color. Refer to the **Product Color Options** page in this price list.
- D** Select shell color. Refer to the **Product Color Options** page in this price list.
- E** Select surface finish. Refer to the **Product Color Options** page in this price list.
- F** Select caster/glide option.
 - C** - Carpet casters
 - S** - Hard floor casters
 - GL** - Glides
 - SCG** - Front hard floor casters, rear

glides
CCG - Front carpet casters, rear glides
G Select upholstery grade/color. Refer to ki.com/fabrics

UPHOLSTERY INFORMATION

C.O.M. Upholstery
 C.O.M. requirement is 5/8 yard per chair for seat of 54" wide nondirectional fabric. For complete information on ordering C.O.M. see "Ordering C.O.M., C.O.V. and C.O.L." section.

FINISH INFORMATION

Poly Bookbag Rack comes standard in Black. Other KI standard poly colors are available through a Product Modification Request. No upcharge or fees apply for orders of 20 or more. A net setup fee applies for orders of 19 or less. Please allow up 1 week additional leadtime.

SPECIAL SERVICES

Special Carton Marking
 With specially marked information N/C
Shipping
 Ships assembled, FOB Green Bay, WI 54302, freight excluded. Freight class 300.

Specifications and prices are subject to change without prior notice.



Learn2® Classroom Furniture (Freight Excluded)

LimeLite™ Seating with Worksurface



Learn2® Classroom Furniture (Freight Excluded)

LimeLite™ Seating with Worksurface

MODEL	Features	MODEL NUMBER							Approx. Packaged Weight	Freight Excluded Pricing	Freight Excluded Pricing Fabric Grade 1, C.O.M. & COV	Freight Excluded Pricing Fabric Grade 2	Freight Excluded Pricing Fabric Grade 3 & Group 2V Vinyl	Freight Excluded Pricing Pallas Fabric Group P0	Freight Excluded Pricing Pallas Fabric Group P1	Freight Excluded Pricing Pallas Fabric Group P2	Freight Excluded Pricing Pallas Fabric Group P3	Freight Excluded Pricing Pallas Fabric Group P4	Laminate Grade 2 add to list price	
		Basic Model	Surface Type	Frame Color	Shell Color	Surface Finish/Plastic Color	Glide Option	Uph. Color												
 Without Accessory Rack • One-piece shell • Passive back flex • Non-handed worksurface in choice of plastic or laminate	Polypropylene	L2LT1/NA/NAR	<input type="checkbox"/>	<input type="checkbox"/>	<input type="checkbox"/>	<input type="checkbox"/>	<input type="checkbox"/>	<input type="checkbox"/>	47.00#	\$ 831									\$ 19	
	Upholstered Seat	L2LT2/NA/NAR	<input type="checkbox"/>	<input type="checkbox"/>	<input type="checkbox"/>	<input type="checkbox"/>	<input type="checkbox"/>	<input type="checkbox"/>	49.00#	N/A	903	935	952	952	944	994	1017	1042	1062	19
2LWS1 2LWS2																				
 Accessory Rack • One-piece shell • Passive back flex • Non-handed worksurface in choice of plastic or laminate • Accessory rack included on both sides of frame	Polypropylene	L2LT1/NA/SAR	<input type="checkbox"/>	<input type="checkbox"/>	<input type="checkbox"/>	<input type="checkbox"/>	<input type="checkbox"/>	<input type="checkbox"/>	55.00#	\$ 861									\$ 19	
	Upholstered Seat	L2LT2/NA/SAR	<input type="checkbox"/>	<input type="checkbox"/>	<input type="checkbox"/>	<input type="checkbox"/>	<input type="checkbox"/>	<input type="checkbox"/>	57.00#	N/A	931	964	980	980	972	1022	1045	1070	1090	19
2LWS1 2LWS2																				
 Cup Holder/Accessory Rack • One-piece shell • Passive back flex • Non-handed worksurface in choice of plastic or laminate • Cup holder/accessory rack included on both sides of frame	Polypropylene	L2LT1/NA/CAR	<input type="checkbox"/>	<input type="checkbox"/>	<input type="checkbox"/>	<input type="checkbox"/>	<input type="checkbox"/>	<input type="checkbox"/>	55.00#	\$ 904									\$ 19	
	Upholstered Seat	L2LT2/NA/CAR	<input type="checkbox"/>	<input type="checkbox"/>	<input type="checkbox"/>	<input type="checkbox"/>	<input type="checkbox"/>	<input type="checkbox"/>	57.00#	N/A	976	1008	1025	1025	1017	1066	1089	1114	1135	19
2LWS1 2LWS2																				

A **B** **C** **D** **E** **F** **G**

HOW TO ORDER

- Indicate the following information on order form:
- Quantity of each item.
 - Model number, including options. See "How To Build a Model Number".
 - Any special service required.

Note: • The indicates that a choice is required.
 • The absence of the indicates that no choice is required.
 • Alpha-numeric characters in place of indicate that no other alternatives are available.

HOW TO BUILD A MODEL NUMBER

- A** Select basic model.
- B** Select worksurface type.
 LW - Laminated worksurface; add \$63
 PW - Plastic worksurface
- C** Select frame color.
 Refer to the **Product Color Options** page in this price list.
- D** Select poly seat and back color.
 Refer to the **Product Color Options** page in this price list.
- E** Select surface finish.
 Refer to the **Product Color Options** page in this price list.
- F** Select caster/glide option.
 C - Carpet casters
 S - Hard floor casters
 GL - Glides
 SCG - Front hard floor casters, rear

glides
CCG - Front carpet casters, rear glides

G Select upholstery grade/color.
 Refer to ki.com/fabrics

UPHOLSTERY INFORMATION

C.O.M. Upholstery
 C.O.M. requirement for 10 chairs or less with upholstered seat or upholstered seat and back is 3/4 yard per chair of 54" wide nondirectional fabric. For orders of 11 or more with upholstered seat and back and for complete information on ordering C.O.M. see "Ordering C.O.M., C.O.V. and C.O.L." section.

SPECIAL SERVICES

Special Carton Marking

With specially marked information N/C

Shipping

Ships assembled, FOB Green Bay, WI 54302, freight excluded. Freight class 300.

Specifications and prices are subject to change without prior notice.



Learn2® Classroom Furniture (Freight Excluded)

LimeLite™ Seating with Worksurface



Learn2® Classroom Furniture (Freight Excluded)

LimeLite™ Seating with Worksurface

MODEL	Features	MODEL NUMBER							Approx. Packaged Weight	Freight Excluded Pricing	Freight Excluded Pricing Fabric Grade 1, C.O.M. & COV	Freight Excluded Pricing Fabric Grade 2	Freight Excluded Pricing Fabric Grade 3 & Group 2V Vinyl	Freight Excluded Pricing Pallas Fabric Group P0	Freight Excluded Pricing Pallas Fabric Group P1	Freight Excluded Pricing Pallas Fabric Group P2	Freight Excluded Pricing Pallas Fabric Group P3	Freight Excluded Pricing Pallas Fabric Group P4	Laminate Grade 2 add to list price	
		Basic Model	Surface Type	Frame Color	Shell Color	Surface Finish/Plastic Color	Glide Option	Uph. Color												
 2LWS1 2LWS2	Poly Bookbag Rack • One-piece shell • Passive back flex • Non-handed worksurface in choice of plastic or laminate • Poly bookbag rack included • Poly bookbag rack includes two accessory slots and a cupholder • Poly Bookbag rack is only available in black	Polyproylene	L2LT1/NA/PBR	<input type="checkbox"/>	<input type="checkbox"/>	<input type="checkbox"/>	<input type="checkbox"/>	<input type="checkbox"/>	51.00#	\$ 882									\$ 19	
		Upholstered Seat	L2LT2/NA/PBR	<input type="checkbox"/>	<input type="checkbox"/>	<input type="checkbox"/>	<input type="checkbox"/>	<input type="checkbox"/>	<input type="checkbox"/>	53.00#	N/A	954	986	1003	1003	995	1045	1068	1092	1113
 2LWS1 2LWS2	Flat Accessory Rack • One-piece shell • Passive back flex • Non-handed worksurface in choice of plastic or laminate • Flat accessory rack included	Polyproylene	L2LT1/NA/FBR	<input type="checkbox"/>	<input type="checkbox"/>	<input type="checkbox"/>	<input type="checkbox"/>	<input type="checkbox"/>	57.00#	\$ 904										\$ 19
		Upholstered Seat	L2LT2/NA/FBR	<input type="checkbox"/>	<input type="checkbox"/>	<input type="checkbox"/>	<input type="checkbox"/>	<input type="checkbox"/>	<input type="checkbox"/>	59.00#	N/A	976	1008	1025	1025	1017	1066	1089	1114	1135
				A	B	C	D	E	F	G										

HOW TO ORDER

- Indicate the following information on order form:
- Quantity of each item.
 - Model number, including options. See "How To Build a Model Number".
 - Any special service required.

Note: • The indicates that a choice is required.
 • The absence of the indicates that no choice is required.
 • Alpha-numeric characters in place of indicate that no other alternatives are available.

HOW TO BUILD A MODEL NUMBER

- A** Select basic model.
- B** Select worksurface type.
 LW - Laminate worksurface; add \$63
 PW - Plastic worksurface
- C** Select frame color.
 Refer to the **Product Color Options** page in this price list.
- D** Select poly seat and back color.
 Refer to the **Product Color Options** page in this price list.
- E** Select surface finish.
 Refer to the **Product Color Options** page in this price list.
- F** Select caster/glide option.
 C - Carpet casters
 S - Hard floor casters
 GL - Glides
 SCG - Front hard floor casters, rear

glides
 CCG - Front carpet casters, rear glides

- G** Select upholstery grade/color.
 Refer to ki.com/fabrics

UPHOLSTERY INFORMATION

C.O.M. Upholstery
 C.O.M. requirement for 10 chairs or less with upholstered seat or upholstered seat and back is 3/4 yard per chair of 54" wide nondirectional fabric. For orders of 11 or more with upholstered seat and back and for complete information on ordering C.O.M. see "Ordering C.O.M., C.O.V. and C.O.L." section.

FINISH INFORMATION

Poly Bookbag Rack comes standard in Black. Other KI standard poly colors are available through a Product Modification Request. No upcharge or fees apply for orders of 20 or more. A net setup fee applies for orders of 19 or less. Please allow up 1 week additional leadtime.

SPECIAL SERVICES

Special Carton Marking

With specially marked information N/C

Shipping

Ships assembled, FOB Green Bay, WI 54302, freight excluded. Freight class 300.

Specifications and prices are subject to change without prior notice.



Learn2® Classroom Furniture (Freight Excluded)

Strive® Seating with Worksurface



Learn2® Classroom Furniture (Freight Excluded)

Strive® Seating with Worksurface

MODEL	Features	MODEL NUMBER							Approx. Packaged Weight	Freight Excluded Pricing	Freight Excluded Pricing Fabric Grade 1, C.O.M. & COV	Freight Excluded Pricing Fabric Grade 2	Freight Excluded Pricing Fabric Grade 3 & Group 2V Vinyl	Freight Excluded Pricing Pallas Fabric Group P0	Freight Excluded Pricing Pallas Fabric Group P1	Freight Excluded Pricing Pallas Fabric Group P2	Freight Excluded Pricing Pallas Fabric Group P3	Freight Excluded Pricing Pallas Fabric Group P4	Laminate Grade 2 add to list price
		Basic Model	Surface Type	Frame Color	Shell Color	Surface Finish/Plastic Color	Glide Option	Uph. Color											
 Without Accessory Rack • Non-handed worksurface in choice of plastic or laminate	Polypropylene	L2STP/NA/NAR	<input type="checkbox"/>	<input type="checkbox"/>	<input type="checkbox"/>	<input type="checkbox"/>	<input type="checkbox"/>	<input type="checkbox"/>	48.00#	\$ 825									\$ 19
	Upholstered Seat	L2STUS/NA/NAR	<input type="checkbox"/>	<input type="checkbox"/>	<input type="checkbox"/>	<input type="checkbox"/>	<input type="checkbox"/>	<input type="checkbox"/>	51.00#	N/A	897	931	945	939	987	1012	1035	1055	19
 Accessory Rack • Non-handed worksurface in choice of plastic or laminate • Accessory rack included on both sides of frame	Polypropylene	L2STP/NA/SAR	<input type="checkbox"/>	<input type="checkbox"/>	<input type="checkbox"/>	<input type="checkbox"/>	<input type="checkbox"/>	<input type="checkbox"/>	57.00#	\$ 854									\$ 19
	Upholstered Seat	L2STUS/NA/SAR	<input type="checkbox"/>	<input type="checkbox"/>	<input type="checkbox"/>	<input type="checkbox"/>	<input type="checkbox"/>	<input type="checkbox"/>	60.00#	N/A	925	958	972	968	1014	1036	1062	1084	19
 Cup Holder/Accessory Rack • Non-handed worksurface in choice of plastic or laminate • Cup holder/accessory rack included on both sides of frame	Polypropylene	L2STP/NA/CAR	<input type="checkbox"/>	<input type="checkbox"/>	<input type="checkbox"/>	<input type="checkbox"/>	<input type="checkbox"/>	<input type="checkbox"/>	57.00#	\$ 898									\$ 19
	Upholstered Seat	L2STUS/NA/CAR	<input type="checkbox"/>	<input type="checkbox"/>	<input type="checkbox"/>	<input type="checkbox"/>	<input type="checkbox"/>	<input type="checkbox"/>	60.00#	N/A	970	1003	1019	1013	1061	1084	1107	1129	19

A **B** **C** **D** **E** **F** **G**

HOW TO ORDER

- Indicate the following information on order form:
- Quantity of each item.
 - Model number, including options. See "How To Build a Model Number".
 - Any special service required.

Note: • The indicates that a choice is required.
 • The absence of the indicates that no choice is required.
 • Alpha-numeric characters in place of indicate that no other alternatives are available.

HOW TO BUILD A MODEL NUMBER

- A** Select basic model.
- B** Select worksurface type.
 - LW - Laminate worksurface; add \$63
 - PW - Plastic worksurface
- C** Select frame color. Refer to the **Product Color Options** page in this price list.
- D** Select poly seat and back color. Refer to the **Product Color Options** page in this price list.
- E** Select surface finish. Refer to the **Product Color Options** page in this price list.
- F** Select caster/glide option.
 - C - Carpet casters
 - S - Hard floor casters
 - GL - Glides
 - SCG - Front hard floor casters, rear

glides
CCG - Front carpet casters, rear glides
G Select upholstery grade/color. Refer to ki.com/fabrics

UPHOLSTERY INFORMATION

C.O.M. Upholstery
 C.O.M. requirement for 10 chairs or less with upholstered seat or upholstered seat and back is 3/4 yard per chair of 54" wide nondirectional fabric. For orders of 11 or more with upholstered seat and back and for complete information on ordering C.O.M. see "Ordering C.O.M., C.O.V. and C.O.L." section.

SPECIAL SERVICES

Special Carton Marking

With specially marked information N/C

Shipping

Ships assembled, FOB Green Bay, WI 54302, freight excluded. Freight class 300.

Specifications and prices are subject to change without prior notice.



Learn2® Classroom Furniture (Freight Excluded)

Strive® Seating with Worksurface



Learn2® Classroom Furniture (Freight Excluded)

Strive® Seating with Worksurface

MODEL	Features	MODEL NUMBER							Approx. Packaged Weight	Freight Excluded Pricing	Freight Excluded Pricing Fabric Grade 1, C.O.M. & COV	Freight Excluded Pricing Fabric Grade 2	Freight Excluded Pricing Fabric Grade 3 & Group 2V Vinyl	Freight Excluded Pricing Pallas Fabric Group P0	Freight Excluded Pricing Pallas Fabric Group P1	Freight Excluded Pricing Pallas Fabric Group P2	Freight Excluded Pricing Pallas Fabric Group P3	Freight Excluded Pricing Pallas Fabric Group P4	Laminate Grade 2 add to list price	
		Basic Model	Surface Type	Frame Color	Shell Color	Surface Finish/Plastic Color	Glide Option	Uph. Color												
 <p>Poly Bookbag Rack</p> <ul style="list-style-type: none"> • Non-handed worksurface in choice of plastic or laminate • Poly bookbag rack included • Poly bookbag rack includes two accessory slots and a cupholder • Poly Bookbag rack is only available in black 	Polypropylene	L2STP/NA/PBR	<input type="checkbox"/>	<input type="checkbox"/>	<input type="checkbox"/>	<input type="checkbox"/>	<input type="checkbox"/>	<input type="checkbox"/>	57.00#	\$ 910									\$ 19	
	Upholstered Seat	L2STUS/NA/PBR	<input type="checkbox"/>	<input type="checkbox"/>	<input type="checkbox"/>	<input type="checkbox"/>	<input type="checkbox"/>	<input type="checkbox"/>	<input type="checkbox"/>	60.00#	N/A	984	1020	1035	1026	1078	1104	1128	1150	19
2SWSP 2SWSU																				
 <p>Flat Accessory Rack</p> <ul style="list-style-type: none"> • Non-handed worksurface in choice of plastic or laminate • Flat accessory rack included 	Polypropylene	L2STP/NA/FBR	<input type="checkbox"/>	<input type="checkbox"/>	<input type="checkbox"/>	<input type="checkbox"/>	<input type="checkbox"/>	<input type="checkbox"/>	57.00#	\$ 898									\$ 19	
	Upholstered Seat	L2STUS/NA/FBR	<input type="checkbox"/>	<input type="checkbox"/>	<input type="checkbox"/>	<input type="checkbox"/>	<input type="checkbox"/>	<input type="checkbox"/>	<input type="checkbox"/>	60.00#	N/A	970	1003	1019	1013	1061	1084	1107	1129	19
2SWSP 2SWSU																				

A **B** **C** **D** **E** **F** **G**

HOW TO ORDER

- Indicate the following information on order form:
- Quantity of each item.
 - Model number, including options. See "How To Build a Model Number".
 - Any special service required.

Note:

- The indicates that a choice is required.
- The absence of the indicates that no choice is required.
- Alpha-numeric characters in place of indicate that no other alternatives are available.

HOW TO BUILD A MODEL NUMBER

- A** Select basic model.
- B** Select worksurface type.
 - LW** - Laminate worksurface; add \$63
 - PW** - Plastic worksurface
- C** Select frame color. Refer to the **Product Color Options** page in this price list.
- D** Select poly seat and back color. Refer to the **Product Color Options** page in this price list.
- E** Select surface finish. Refer to the **Product Color Options** page in this price list.
- F** Select caster/glide option.
 - C** - Carpet casters
 - S** - Hard floor casters
 - GL** - Glides
 - SCG** - Front hard floor casters, rear

glides
CCG - Front carpet casters, rear glides

G Select upholstery grade/color. Refer to ki.com/fabrics

UPHOLSTERY INFORMATION

C.O.M. Upholstery
C.O.M. requirement for 10 chairs or less with upholstered seat or upholstered seat and back is 3/4 yard per chair of 54" wide nondirectional fabric. For orders of 11 or more with upholstered seat and back and for complete information on ordering C.O.M. see "Ordering C.O.M., C.O.V. and C.O.L." section.

FINISH INFORMATION

Poly Bookbag Rack comes standard in Black. Other KI standard poly colors are available through a Product Modification Request. No upcharge or fees apply for orders of 20 or more. A net setup fee applies for orders of 19 or less. Please allow up 1 week additional leadtime.

SPECIAL SERVICES

Special Carton Marking

With specially marked information N/C

Shipping

Ships assembled, FOB Green Bay, WI 54302, freight excluded. Freight class 300.

Specifications and prices are subject to change without prior notice.



Learn2® Classroom Furniture (Freight Excluded)

Strive® Seating with Worksurface



Learn2® Classroom Furniture (Freight Excluded)

Strive® Seating with Worksurface

MODEL	Features	MODEL NUMBER							Approx. Packaged Weight	Freight Excluded Pricing	Freight Excluded Pricing Fabric Grade 1, C.O.M. & COV	Freight Excluded Pricing Fabric Grade 2	Freight Excluded Pricing Fabric Grade 3 & Group 2V Vinyl	Freight Excluded Pricing Pallas Fabric Group P0	Freight Excluded Pricing Pallas Fabric Group P1	Freight Excluded Pricing Pallas Fabric Group P2	Freight Excluded Pricing Pallas Fabric Group P3	Freight Excluded Pricing Pallas Fabric Group P4	Laminate Grade 2 add to list price
		Basic Model	Surface Type	Frame Color	Shell Color	Surface Finish/Plastic Color	Glide Option	Uph. Color											
 2SWSP 2SWSU	Armchair without Accessory Rack • Non-handed worksurface in choice of plastic or laminate	Polypropylene	L2STP/CA/NAR	<input type="checkbox"/>	<input type="checkbox"/>	<input type="checkbox"/>	<input type="checkbox"/>	<input type="checkbox"/>	51.00#	\$ 895									\$ 19
		Upholstered Seat	L2STUS/CA/NAR	<input type="checkbox"/>	<input type="checkbox"/>	<input type="checkbox"/>	<input type="checkbox"/>	<input type="checkbox"/>	<input type="checkbox"/>	54.00#	N/A	968	998	1014	1008	1055	1080	1103	1125
 2SWSP 2SWSU	Armchair with Accessory Rack • Non-handed worksurface in choice of plastic or laminate • Accessory rack included on both sides of frame	Polypropylene	L2STP/CA/SAR	<input type="checkbox"/>	<input type="checkbox"/>	<input type="checkbox"/>	<input type="checkbox"/>	<input type="checkbox"/>	60.00#	\$ 922									\$ 19
		Upholstered Seat	L2STUS/CA/SAR	<input type="checkbox"/>	<input type="checkbox"/>	<input type="checkbox"/>	<input type="checkbox"/>	<input type="checkbox"/>	<input type="checkbox"/>	63.00#	N/A	993	1025	1040	1035	1084	1106	1131	1151
 2SWSP 2SWSU	Armchair with Cup Holder/Accessory Rack • Non-handed worksurface in choice of plastic or laminate • Cup holder/accessory rack included on both sides of frame	Polypropylene	L2STP/CA/CAR	<input type="checkbox"/>	<input type="checkbox"/>	<input type="checkbox"/>	<input type="checkbox"/>	<input type="checkbox"/>	60.00#	\$ 968									\$ 19
		Upholstered Seat	L2STUS/CA/CAR	<input type="checkbox"/>	<input type="checkbox"/>	<input type="checkbox"/>	<input type="checkbox"/>	<input type="checkbox"/>	<input type="checkbox"/>	63.00#	N/A	1037	1070	1087	1081	1129	1151	1177	1198

A **B** **C** **D** **E** **F** **G**

HOW TO ORDER

- Indicate the following information on order form:
- Quantity of each item.
 - Model number, including options. See "How To Build a Model Number".
 - Any special service required.

Note:

- The indicates that a choice is required.
- The absence of the indicates that no choice is required.
- Alpha-numeric characters in place of indicate that no other alternatives are available.

HOW TO BUILD A MODEL NUMBER

- A** Select basic model.
- B** Select worksurface type.
 - LW** - Laminate worksurface; add \$63
 - PW** - Plastic worksurface
- C** Select frame color. Refer to the **Product Color Options** page in this price list.
- D** Select poly seat and back color. Refer to the **Product Color Options** page in this price list.
- E** Select surface finish. Refer to the **Product Color Options** page in this price list.
- F** Select caster/glide option.
 - C** - Carpet casters
 - S** - Hard floor casters
 - GL** - Glides
 - SCG** - Front hard floor casters, rear

glides
CCG - Front carpet casters, rear glides

G Select upholstery grade/color. Refer to ki.com/fabrics

UPHOLSTERY INFORMATION

C.O.M. Upholstery
 C.O.M. requirement for 10 chairs or less with upholstered seat or upholstered seat and back is 3/4 yard per chair of 54" wide nondirectional fabric. For orders of 11 or more with upholstered seat and back and for complete information on ordering C.O.M. see "Ordering C.O.M., C.O.V. and C.O.L." section.

SPECIAL SERVICES

Special Carton Marking

With specially marked information N/C

Shipping

Ships assembled, FOB Green Bay, WI 54302, freight excluded. Freight class 300.

Specifications and prices are subject to change without prior notice.



Learn2® Classroom Furniture (Freight Excluded)

Strive® Seating with Worksurface



Learn2® Classroom Furniture (Freight Excluded)

Strive® Seating with Worksurface

MODEL	Features	MODEL NUMBER							Approx. Packaged Weight	Freight Excluded Pricing	Freight Excluded Pricing Fabric Grade 1, C.O.M. & COV	Freight Excluded Pricing Fabric Grade 2	Freight Excluded Pricing Fabric Grade 3 & Group 2V Vinyl	Freight Excluded Pricing Pallas Fabric Group P0	Freight Excluded Pricing Pallas Fabric Group P1	Freight Excluded Pricing Pallas Fabric Group P2	Freight Excluded Pricing Pallas Fabric Group P3	Freight Excluded Pricing Pallas Fabric Group P4	Laminate Grade 2 add to list price
		Basic Model	Surface Type	Frame Color	Shell Color	Surface Finish/Plastic Color	Glide Option	Uph. Color											
 <p>Armchair with Poly Bookbag Rack</p> <ul style="list-style-type: none"> • Non-handed worksurface in choice of plastic or laminate • Poly bookbag rack included • Poly bookbag rack includes two accessory slots and a cupholder • Poly Bookbag rack is only available in black 	Polypropylene	L2STP/CA/PBR	<input type="checkbox"/>	<input type="checkbox"/>	<input type="checkbox"/>	<input type="checkbox"/>	<input type="checkbox"/>	60.00#	\$ 983										\$ 19
	Upholstered Seat	L2STUS/CA/PBR	<input type="checkbox"/>	<input type="checkbox"/>	<input type="checkbox"/>	<input type="checkbox"/>	<input type="checkbox"/>	<input type="checkbox"/>	63.00#	N/A	1058	1089	1106	1101	1150	1174	1199	1221	19
2SWSP 2SWSU																			
 <p>Armchair with Flat Accessory Rack</p> <ul style="list-style-type: none"> • Non-handed worksurface in choice of plastic or laminate • Flat accessory rack included 	Polypropylene	L2STP/CA/FBR	<input type="checkbox"/>	<input type="checkbox"/>	<input type="checkbox"/>	<input type="checkbox"/>	<input type="checkbox"/>	60.00#	\$ 968										\$ 19
	Upholstered Seat	L2STUS/CA/FBR	<input type="checkbox"/>	<input type="checkbox"/>	<input type="checkbox"/>	<input type="checkbox"/>	<input type="checkbox"/>	<input type="checkbox"/>	63.00#	N/A	1037	1070	1087	1081	1129	1151	1177	1198	19
2SWSP 2SWSU																			

A **B** **C** **D** **E** **F** **G**

HOW TO ORDER

- Indicate the following information on order form:
1. Quantity of each item.
 2. Model number, including options. See "How To Build a Model Number".
 3. Any special service required.

Note:

- The indicates that a choice is required.
- The absence of the indicates that no choice is required.
- Alpha-numeric characters in place of indicate that no other alternatives are available.

HOW TO BUILD A MODEL NUMBER

- A** Select basic model.
- B** Select worksurface type.
 - LW** - Laminate worksurface; add \$63
 - PW** - Plastic worksurface
- C** Select frame color. Refer to the **Product Color Options** page in this price list.
- D** Select poly seat and back color. Refer to the **Product Color Options** page in this price list.
- E** Select surface finish. Refer to the **Product Color Options** page in this price list.
- F** Select caster/glide option.
 - C** - Carpet casters
 - S** - Hard floor casters
 - GL** - Glides
 - SCG** - Front hard floor casters, rear

glides
CCG - Front carpet casters, rear glides

G Select upholstery grade/color. Refer to ki.com/fabrics

UPHOLSTERY INFORMATION

C.O.M. Upholstery
C.O.M. requirement for 10 chairs or less with upholstered seat or upholstered seat and back is 3/4 yard per chair of 54" wide nondirectional fabric. For orders of 11 or more with upholstered seat and back and for complete information on ordering C.O.M. see "Ordering C.O.M., C.O.V. and C.O.L." section.

FINISH INFORMATION

Poly Bookbag Rack comes standard in Black. Other KI standard poly colors are available through a Product Modification Request. No upcharge or fees apply for orders of 20 or more. A net setup fee applies for orders of 19 or less. Please allow up 1 week additional leadtime.

SPECIAL SERVICES

Special Carton Marking
With specially marked information N/C

Shipping
Ships assembled, FOB Green Bay, WI 54302, freight excluded. Freight class 300.

Specifications and prices are subject to change without prior notice.



Learn2® Classroom Furniture (Freight Excluded)

Doni® Seating without Worksurface



Learn2® Classroom Furniture (Freight Excluded)

Doni® Seating without Worksurface

MODEL	Features	MODEL NUMBER						Approx. Packaged Weight	Freight Excluded Pricing Upholstered	Freight Excluded Pricing Fabric Grade 1, C.O.M. & COV	Freight Excluded Pricing Fabric Grade 2	Freight Excluded Pricing Fabric Grade 3 & Group 2V Vinyl	Freight Excluded Pricing Pallas Fabric Group P0	Freight Excluded Pricing Pallas Fabric Group P1	Freight Excluded Pricing Pallas Fabric Group P2	Freight Excluded Pricing Pallas Fabric Group P3	Freight Excluded Pricing Pallas Fabric Group P4
		Basic Model	Frame Color	Poly Solid Color	Poly Outside/Inside Color	Glide Option	Uph. Color										
 <p>No Work Surface - Without Accessory Rack</p> <ul style="list-style-type: none"> Solid or two-tone colored shell Unlimited color match's 17 degrees of hip articulation 	Solid Color, Polypropylene	L2DN1/NAR	<input type="checkbox"/>	<input type="checkbox"/>		<input type="checkbox"/>	57.00#	\$ 710									
	Solid Color, Upholstered Seat	L2DN2/NAR	<input type="checkbox"/>	<input type="checkbox"/>		<input type="checkbox"/>	57.00#	N/A	857	868	888	898	951	969	993	1028	
	Two-Tone, Polypropylene	L2DNA/NAR	<input type="checkbox"/>		<input type="checkbox"/>	<input type="checkbox"/>	57.00#	779									
	Two-Tone, Upholstered Seat	L2DNB/NAR	<input type="checkbox"/>		<input type="checkbox"/>	<input type="checkbox"/>	57.00#	N/A	926	936	957	969	1020	1036	1062	1101	
2DNS1																	
2DNS2																	
2DNSA																	
2DNSB																	
 <p>No Worksurface - Accessory Rack</p> <ul style="list-style-type: none"> Accessory rack included on both sides of frame Solid or two-tone colored shell Unlimited color match's 17 degrees of hip articulation 	Solid Color, Polypropylene	L2DN1/SAR	<input type="checkbox"/>	<input type="checkbox"/>		<input type="checkbox"/>	57.00#	\$ 738									
	Solid Color, Upholstered Seat	L2DN2/SAR	<input type="checkbox"/>	<input type="checkbox"/>		<input type="checkbox"/>	57.00#	N/A	885	896	920	928	978	998	1023	1059	
	Two-Tone, Polypropylene	L2DNA/SAR	<input type="checkbox"/>		<input type="checkbox"/>	<input type="checkbox"/>	57.00#	808									
	Two-Tone, Upholstered Seat	L2DNB/SAR	<input type="checkbox"/>		<input type="checkbox"/>	<input type="checkbox"/>	57.00#	N/A	955	967	985	998	1048	1066	1092	1128	
2DNS1																	
2DNS2																	
2DNSA																	
2DNSB																	

A B C D E F

HOW TO ORDER

- Indicate the following information on order form:
- Quantity of each item.
 - Model number, including options. See "How To Build a Model Number".
 - Any special service required.

Note:

- The indicates that a choice is required.
- The absence of the indicates that no choice is required.
- Alpha-numeric characters in place of indicate that no other alternatives are available.

HOW TO BUILD A MODEL NUMBER

Refer to ki.com/fabrics

- A** Select basic model.
- B** Select frame color. Refer to the **Product Color Options** page in this price list.
- C** Select solid poly color. Refer to the **Product Color Options** page in this price list.
- D** Select outside/inside poly color. Refer to the **Product Color Options** page in this price list.
- E** Select caster/glide option.
 - C** - Carpet casters
 - S** - Hard floor casters
 - GL** - Glides
 - SCG** - Front hard floor casters, rear glides
 - CCG** - Front carpet casters, rear glides
- F** Select upholstery grade/color.

UPHOLSTERY INFORMATION

C.O.M. Upholstery

C.O.M. requirement for 10 chairs or less with upholstered seat or upholstered seat and back is 3/4 yard per chair of 54" wide nondirectional fabric. For orders of 11 or more with upholstered seat and back and for complete information on ordering C.O.M. see "Ordering C.O.M., C.O.V. and C.O.L." section.

SPECIAL SERVICES

Special Carton Marking

With specially marked information N/C

Shipping

Ships assembled, FOB Green Bay, WI 54302, freight excluded. Freight class 300.

Specifications and prices are subject to change without prior notice.

Learn2® Classroom Furniture (Freight Excluded)

Doni® Seating without Worksurface



Learn2® Classroom Furniture (Freight Excluded)

Doni® Seating without Worksurface

MODEL	Features	MODEL NUMBER						Approx. Packaged Weight	Freight Excluded Pricing Upholstered	Freight Excluded Pricing Fabric Grade 1, C.O.M. & COV	Freight Excluded Pricing Fabric Grade 2	Freight Excluded Pricing Fabric Grade 3 & Group 2V Vinyl	Freight Excluded Pricing Pallas Fabric Group P0	Freight Excluded Pricing Pallas Fabric Group P1	Freight Excluded Pricing Pallas Fabric Group P2	Freight Excluded Pricing Pallas Fabric Group P3	Freight Excluded Pricing Pallas Fabric Group P4	
		Basic Model	Frame Color	Poly Solid Color	Poly Outside/Inside Color	Glide Option	Uph. Color											
 <p>No Worksurface - Cup Holder/Accessory Rack</p> <ul style="list-style-type: none"> Cup holder/accessory rack included on both sides of frame Solid or two-tone colored shell Unlimited color match's 17 degrees of hip articulation 	Solid Color, Polypropylene	L2DN1/CAR	<input type="checkbox"/>	<input type="checkbox"/>		<input type="checkbox"/>	57.00#	\$ 786										
	Solid Color, Upholstered Seat	L2DN2/CAR	<input type="checkbox"/>	<input type="checkbox"/>		<input type="checkbox"/>	<input type="checkbox"/>	57.00#	N/A	931	942	964	976	1025	1046	1069	1105	
	Two-Tone, Polypropylene	L2DNA/CAR	<input type="checkbox"/>		<input type="checkbox"/>	<input type="checkbox"/>	<input type="checkbox"/>	57.00#	855									
	Two-Tone, Upholstered Seat	L2DNB/CAR	<input type="checkbox"/>		<input type="checkbox"/>	<input type="checkbox"/>	<input type="checkbox"/>	57.00#	N/A	1004	1011	1033	1046	1095	1112	1139	1174	

- 2DNS1
- 2DNS2
- 2DNSA
- 2DNSB

A **B** **C** **D** **E** **F**

HOW TO ORDER

- Indicate the following information on order form:
- Quantity of each item.
 - Model number, including options. See "How To Build a Model Number".
 - Any special service required.

Note:

- The indicates that a choice is required.
- The absence of the indicates that no choice is required.
- Alpha-numeric characters in place of indicate that no other alternatives are available.

HOW TO BUILD A MODEL NUMBER

Refer to ki.com/fabrics

- A** Select basic model.
- B** Select frame color. Refer to the **Product Color Options** page in this price list.
- C** Select solid poly color. Refer to the **Product Color Options** page in this price list.
- D** Select outside/inside poly color. Refer to the **Product Color Options** page in this price list.
- E** Select caster/glide option.
 - C** - Carpet casters
 - S** - Hard floor casters
 - GL** - Glides
 - SCG** - Front hard floor casters, rear glides
 - CCG** - Front carpet casters, rear glides
- F** Select upholstery grade/color.

UPHOLSTERY INFORMATION

C.O.M. Upholstery
 C.O.M. requirement for 10 chairs or less with upholstered seat or upholstered seat and back is 3/4 yard per chair of 54" wide nondirectional fabric. For orders of 11 or more with upholstered seat and back and for complete information on ordering C.O.M. see "Ordering C.O.M., C.O.V. and C.O.L." section.

SPECIAL SERVICES

Special Carton Marking
 With specially marked information N/C

Shipping
 Ships assembled, FOB Green Bay, WI 54302, freight excluded. Freight class 300.

Specifications and prices are subject to change without prior notice.

Learn2® Classroom Furniture (Freight Excluded)

Doni® Seating without Worksurface



Learn2® Classroom Furniture (Freight Excluded)

Doni® Seating without Worksurface

MODEL	Features	MODEL NUMBER						Approx. Packaged Weight	Freight Excluded Pricing Upholstered	Freight Excluded Pricing Fabric Grade 1, C.O.M. & COV	Freight Excluded Pricing Fabric Grade 2	Freight Excluded Pricing Fabric Grade 3 & Group 2V Vinyl	Freight Excluded Pricing Pallas Fabric Group P0	Freight Excluded Pricing Pallas Fabric Group P1	Freight Excluded Pricing Pallas Fabric Group P2	Freight Excluded Pricing Pallas Fabric Group P3	Freight Excluded Pricing Pallas Fabric Group P4
		Basic Model	Frame Color	Poly Solid Color	Poly Outside/Inside Color	Glide Option	Uph. Color										
 <p>No Worksurface - Poly Bookbag Rack</p> <ul style="list-style-type: none"> • Poly bookbag rack included • Poly bookbag rack includes two accessory slots and a cupholder • Poly Bookbag rack is only available in black • Solid or two-tone colored shell • Unlimited color match's • 17 degrees of hip articulation 	Solid Color, Polypropylene	L2DN1/PBR	<input type="checkbox"/>	<input type="checkbox"/>		<input type="checkbox"/>	57.00#	\$ 762									
	Solid Color, Upholstered Seat	L2DN2/PBR	<input type="checkbox"/>	<input type="checkbox"/>		<input type="checkbox"/>	57.00#	N/A	910	921	941	952	1004	1022	1046	1080	
	Two-Tone, Polypropylene	L2DNA/PBR	<input type="checkbox"/>		<input type="checkbox"/>	<input type="checkbox"/>	57.00#	831									
	Two-Tone, Upholstered Seat	L2DNB/PBR	<input type="checkbox"/>		<input type="checkbox"/>	<input type="checkbox"/>	57.00#	N/A	979	989	1010	1022	1073	1089	1116	1153	

2DNS1
2DNS2
2DNSA
2DNSB

A **B** **C** **D** **E** **F**

HOW TO ORDER

- Indicate the following information on order form:
- Quantity of each item.
 - Model number, including options. See "How To Build a Model Number".
 - Any special service required.

Note:

- The indicates that a choice is required.
- The absence of the indicates that no choice is required.
- Alpha-numeric characters in place of indicate that no other alternatives are available.

HOW TO BUILD A MODEL NUMBER

Refer to ki.com/fabrics

- A** Select basic model.
- B** Select frame color.
Refer to the **Product Color Options** page in this price list.
- C** Select solid poly color.
Refer to the **Product Color Options** page in this price list.
- D** Select outside/inside poly color.
Refer to the **Product Color Options** page in this price list.
- E** Select caster/glide option.
 - C** - Carpet casters
 - S** - Hard floor casters
 - GL** - Glides
 - SCG** - Front hard floor casters, rear glides
 - CCG** - Front carpet casters, rear glides
- F** Select upholstery grade/color.

UPHOLSTERY INFORMATION

C.O.M. Upholstery
C.O.M. requirement for 10 chairs or less with upholstered seat or upholstered seat and back is 3/4 yard per chair of 54" wide nondirectional fabric. For orders of 11 or more with upholstered seat and back and for complete information on ordering C.O.M. see "Ordering C.O.M., C.O.V. and C.O.L." section.

FINISH INFORMATION

Poly Bookbag Rack comes standard in Black. Other KI standard poly colors are available through a Product Modification Request. No upcharge or fees apply for orders of 20 or more. A net setup fee applies for orders of 19 or less. Please allow up 1 week additional leadtime.

SPECIAL SERVICES

Special Carton Marking

With specially marked information N/C

Shipping
Ships **assembled, FOB Green Bay, WI 54302, freight excluded.** Freight class 300.

Specifications and prices are subject to change without prior notice.

Learn2® Classroom Furniture (Freight Excluded)

Doni® Seating without Worksurface



Learn2® Classroom Furniture (Freight Excluded)

Doni® Seating without Worksurface

MODEL	Features	MODEL NUMBER						Approx. Packaged Weight	Freight Excluded Pricing Unupholstered	Freight Excluded Pricing Fabric Grade 1, C.O.M. & COV	Freight Excluded Pricing Fabric Grade 2	Freight Excluded Pricing Fabric Grade 3 & Group 2V Vinyl	Freight Excluded Pricing Pallas Fabric Group P0	Freight Excluded Pricing Pallas Fabric Group P1	Freight Excluded Pricing Pallas Fabric Group P2	Freight Excluded Pricing Pallas Fabric Group P3	Freight Excluded Pricing Pallas Fabric Group P4
		Basic Model	Frame Color	Poly Solid Color	Poly Outside/Inside Color	Glide Option	Uph. Color										
 <p>No Worksurface - Flat Accessory Rack</p> <ul style="list-style-type: none"> • Flat accessory rack included • Solid or two-tone colored shell • Unlimited color match's • 17 degrees of hip articulation 	Solid Color, Polypropylene	L2DN1/FBR	<input type="checkbox"/>	<input type="checkbox"/>		<input type="checkbox"/>	57.00#	\$ 786									
	Solid Color, Upholstered Seat	L2DN2/FBR	<input type="checkbox"/>	<input type="checkbox"/>		<input type="checkbox"/>	57.00#	N/A	931	942	964	976	1025	1046	1069	1105	
	Two-Tone, Polypropylene	L2DNA/FBR	<input type="checkbox"/>		<input type="checkbox"/>	<input type="checkbox"/>	57.00#	855									
	Two-Tone, Upholstered Seat	L2DNB/FBR	<input type="checkbox"/>		<input type="checkbox"/>	<input type="checkbox"/>	57.00#	N/A	1004	1011	1033	1046	1095	1112	1139	1174	

2DNS1
2DNS2
2DNSA
2DNSB

A **B** **C** **D** **E** **F**

HOW TO ORDER

- Indicate the following information on order form:
1. Quantity of each item.
 2. Model number, including options. See "How To Build a Model Number".
 3. Any special service required.

Note:

- The indicates that a choice is required.
- The absence of the indicates that no choice is required.
- Alpha-numeric characters in place of indicate that no other alternatives are available.

HOW TO BUILD A MODEL NUMBER

Refer to ki.com/fabrics

- A** Select basic model.
- B** Select frame color. Refer to the **Product Color Options** page in this price list.
- C** Select solid poly color. Refer to the **Product Color Options** page in this price list.
- D** Select outside/inside poly color. Refer to the **Product Color Options** page in this price list.
- E** Select caster/glide option.
 - C** - Carpet casters
 - S** - Hard floor casters
 - GL** - Glides
 - SCG** - Front hard floor casters, rear glides
 - CCG** - Front carpet casters, rear glides
- F** Select upholstery grade/color.

UPHOLSTERY INFORMATION

C.O.M. Upholstery
C.O.M. requirement for 10 chairs or less with upholstered seat or upholstered seat and back is 3/4 yard per chair of 54" wide nondirectional fabric. For orders of 11 or more with upholstered seat and back and for complete information on ordering C.O.M. see "Ordering C.O.M., C.O.V. and C.O.L." section.

SPECIAL SERVICES

Special Carton Marking
With specially marked information N/C

Shipping
Ships assembled, FOB Green Bay, WI 54302, freight excluded. Freight class 300.

Specifications and prices are subject to change without prior notice.



Learn2® Classroom Furniture (Freight Excluded)

Intellect Wave® Seating without Worksurface



Learn2® Classroom Furniture (Freight Excluded)

Intellect Wave® Seating without Worksurface

MODEL	Features	MODEL NUMBER					Approx. Packaged Weight	Freight Excluded Pricing	Freight Excluded Pricing Fabric Grade 1, C.O.M. & COV	Freight Excluded Pricing Fabric Grade 2	Freight Excluded Pricing Fabric Grade 3 & Group 2V Vinyl	Freight Excluded Pricing Pallas Fabric Group P0	Freight Excluded Pricing Pallas Fabric Group P1	Freight Excluded Pricing Pallas Fabric Group P2	Freight Excluded Pricing Pallas Fabric Group P3	Freight Excluded Pricing Pallas Fabric Group P4
		Basic Model	Frame Color	Shell Color	Glide Option	Upholstery Color										
 2WNSP 2WNSU	No Worksurface - Without Accessory Rack Polypropylene Upholstered Seat	L2WNP/NAR	<input type="checkbox"/>	<input type="checkbox"/>	<input type="checkbox"/>		33.00#	\$ 508								
		L2WNUS/NAR	<input type="checkbox"/>	<input type="checkbox"/>	<input type="checkbox"/>	<input type="checkbox"/>		36.00#	N/A	577	580	592	580	626	645	665
 2WNSP 2WNSU	No Worksurface - Accessory Rack • Accessory rack included on both sides of frame Polypropylene Upholstered Seat	L2WNP/SAR	<input type="checkbox"/>	<input type="checkbox"/>	<input type="checkbox"/>		42.00#	\$ 533								
		L2WNUS/SAR	<input type="checkbox"/>	<input type="checkbox"/>	<input type="checkbox"/>	<input type="checkbox"/>		45.00#	N/A	603	608	620	608	655	672	691
 2WNSP 2WNSU	No Worksurface - Cup Holder/Accessory Rack • Cup holder/accessory rack included on both sides of frame Polypropylene Upholstered Seat	L2WNP/CAR	<input type="checkbox"/>	<input type="checkbox"/>	<input type="checkbox"/>		42.00#	\$ 579								
		L2WNUS/CAR	<input type="checkbox"/>	<input type="checkbox"/>	<input type="checkbox"/>	<input type="checkbox"/>		45.00#	N/A	648	651	662	651	700	717	736

A **B** **C** **D** **E**

HOW TO ORDER

- Indicate the following information on order form:
- Quantity of each item.
 - Model number, including options. See "How To Build a Model Number".
 - Any special service required.

Note: • The indicates that a choice is required.
 • The absence of the indicates that no choice is required.
 • Alpha-numeric characters in place of indicate that no other alternatives are available.

HOW TO BUILD A MODEL NUMBER

- A** Select basic model.
- B** Select frame color. Refer to the **Product Color Options** page in this price list.
- C** Select shell color. Refer to the **Product Color Options** page in this price list.
- D** Select caster/glide option.

C	- Carpet casters
S	- Hard floor casters
GL	- Glides
SCG	- Front hard floor casters, rear glides
CCG	- Front carpet casters, rear glides
- E** Select upholstery grade/color. Refer to ki.com/fabrics

UPHOLSTERY INFORMATION

C.O.M. Upholstery
 C.O.M. requirement is 5/8 yard per chair for seat of 54" wide nondirectional fabric. For complete information on ordering C.O.M. see "Ordering C.O.M., C.O.V. and C.O.L." section.

SPECIAL SERVICES

Special Carton Marking

With specially marked information N/C

Shipping
 Ships assembled, FOB Green Bay, WI 54302, freight excluded. Freight class 300.

Specifications and prices are subject to change without prior notice.



Learn2® Classroom Furniture (Freight Excluded)

Intellect Wave® Seating without Worksurface



Learn2® Classroom Furniture (Freight Excluded)

Intellect Wave® Seating without Worksurface

MODEL	Features	MODEL NUMBER					Approx. Packaged Weight	Freight Excluded Pricing	Freight Excluded Pricing Fabric Grade 1, C.O.M. & COV	Freight Excluded Pricing Fabric Grade 2	Freight Excluded Pricing Fabric Grade 3 & Group 2V Vinyl	Freight Excluded Pricing Pallas Fabric Group P0	Freight Excluded Pricing Pallas Fabric Group P1	Freight Excluded Pricing Pallas Fabric Group P2	Freight Excluded Pricing Pallas Fabric Group P3	Freight Excluded Pricing Pallas Fabric Group P4
		Basic Model	Frame Color	Shell Color	Glide Option	Upholstery Color										
 2WNSP 2WNSU	No Worksurface - Poly Bookbag Rack • Poly bookbag rack included • Poly bookbag rack includes two accessory slots and a cupholder • Poly Bookbag rack is only available in black	Polypropylene	L2WNP/PBR	<input type="checkbox"/>	<input type="checkbox"/>	<input type="checkbox"/>	42.00#	\$ 558								
		Upholstered Seat	L2WNUS/PBR	<input type="checkbox"/>	<input type="checkbox"/>	<input type="checkbox"/>	<input type="checkbox"/>	45.00#	N/A	626	630	642	630	676	696	714
 2WNSP 2WNSU	No Worksurface - Flat Accessory Rack • Flat accessory rack included	Polypropylene	L2WNP/FBR	<input type="checkbox"/>	<input type="checkbox"/>	<input type="checkbox"/>	42.00#	\$ 579								
		Upholstered Seat	L2WNUS/FBR	<input type="checkbox"/>	<input type="checkbox"/>	<input type="checkbox"/>	<input type="checkbox"/>	45.00#	N/A	648	651	662	651	700	717	736

A **B** **C** **D** **E**

HOW TO ORDER

- Indicate the following information on order form:
- Quantity of each item.
 - Model number, including options. See "How To Build a Model Number".
 - Any special service required.

Note: • The indicates that a choice is required.
 • The absence of the indicates that no choice is required.
 • Alpha-numeric characters in place of indicate that no other alternatives are available.

HOW TO BUILD A MODEL NUMBER

- A** Select basic model.
- B** Select frame color.
Refer to the **Product Color Options** page in this price list.
- C** Select shell color.
Refer to the **Product Color Options** page in this price list.
- D** Select caster/glide option.

C	- Carpet casters
S	- Hard floor casters
GL	- Glides
SCG	- Front hard floor casters, rear glides
CCG	- Front carpet casters, rear glides
- E** Select upholstery grade/color.
Refer to ki.com/fabrics

UPHOLSTERY INFORMATION

C.O.M. Upholstery
 C.O.M. requirement is 5/8 yard per chair for seat of 54" wide nondirectional fabric. For complete information on ordering C.O.M. see "Ordering C.O.M., C.O.V. and C.O.L." section.

FINISH INFORMATION

Poly Bookbag Rack comes standard in Black. Other KI standard poly colors are available through a Product Modification Request. No upcharge or fees apply for orders of 20 or more. A net setup fee applies for orders of 19 or less. Please allow up 1 week additional leadtime.

SPECIAL SERVICES

Special Carton Marking

With specially marked information N/C

Shipping
 Ships **assembled, FOB Green Bay, WI 54302, freight excluded.** Freight class 300.

Specifications and prices are subject to change without prior notice.



Learn2® Classroom Furniture (Freight Excluded)

LimeLite™ Seating without Worksurface



Learn2® Classroom Furniture (Freight Excluded)

LimeLite™ Seating without Worksurface

MODEL	Features	MODEL NUMBER					Approx. Packaged Weight	Freight Excluded Pricing	Freight Excluded Pricing Fabric Grade 1, C.O.M. & COV	Freight Excluded Pricing Fabric Grade 2	Freight Excluded Pricing Fabric Grade 3 & Group 2V Vinyl	Freight Excluded Pricing Pallas Fabric Group P0	Freight Excluded Pricing Pallas Fabric Group P1	Freight Excluded Pricing Pallas Fabric Group P2	Freight Excluded Pricing Pallas Fabric Group P3	Freight Excluded Pricing Pallas Fabric Group P4
		Basic Model	Frame Color	Shell Color	Glide Option	Uph. Color										
 2LNS1 2LNS2	No Worksurface - Without Accessory Rack Polypropylene Upholstered Seat • One-piece shell • Passive back flex	L2LN1/NA/NAR	<input type="checkbox"/>	<input type="checkbox"/>	<input type="checkbox"/>	45.00#	\$ 664									
		L2LN2/NA/NAR	<input type="checkbox"/>	<input type="checkbox"/>	<input type="checkbox"/>	<input type="checkbox"/>	47.00#	N/A	736	736	768	768	776	826	849	874
 2LNS1 2LNS2	No Worksurface - Accessory Rack Polypropylene Upholstered Seat • One-piece shell • Passive black flex • Accessory rack included on both sides of frame	L2LN1/NA/SAR	<input type="checkbox"/>	<input type="checkbox"/>	<input type="checkbox"/>	53.00#	\$ 691									
		L2LN2/NA/SAR	<input type="checkbox"/>	<input type="checkbox"/>	<input type="checkbox"/>	<input type="checkbox"/>	55.00#	N/A	761	793	810	810	801	851	874	899
 2LNS1 2LNS2	No Worksurface - Cup Holder/Accessory Rack Polypropylene Upholstered Seat • One-piece shell • Passive back flex • Cup holder/accessory rack included on both sides of frame	L2LN1/NA/CAR	<input type="checkbox"/>	<input type="checkbox"/>	<input type="checkbox"/>	53.00#	\$ 737									
		L2LN2/NA/CAR	<input type="checkbox"/>	<input type="checkbox"/>	<input type="checkbox"/>	<input type="checkbox"/>	55.00#	N/A	805	838	854	854	846	896	919	944

A **B** **C** **D** **E**

HOW TO ORDER

- Indicate the following information on order form:
- Quantity of each item.
 - Model number, including options. See "How To Build a Model Number".
 - Any special service required.

Note: • The indicates that a choice is required.
 • The absence of the indicates that no choice is required.
 • Alpha-numeric characters in place of indicate that no other alternatives are available.

HOW TO BUILD A MODEL NUMBER

- A** Select basic model.
- B** Select frame color.
Refer to the **Product Color Options** page in this price list.
- C** Select poly seat and back color.
Refer to the **Product Color Options** page in this price list.
- D** Select caster/glide option.

C	- Carpet casters
S	- Hard floor casters
GL	- Glides
SCG	- Front hard floor casters, rear glides
CCG	- Front carpet casters, rear glides
- E** Select upholstery grade/color.
Refer to ki.com/fabrics

UPHOLSTERY INFORMATION

C.O.M. Upholstery
 C.O.M. requirement for 10 chairs or less with upholstered seat or upholstered seat and back is 3/4 yard per chair of 54" wide nondirectional fabric. For orders of 11 or more with upholstered seat and back and for complete information on ordering C.O.M. see "Ordering C.O.M., C.O.V. and C.O.L." section.

SPECIAL SERVICES

Special Carton Marking

With specially marked information N/C

Shipping
 Ships assembled, FOB Green Bay, WI 54302, freight excluded. Freight class 300.

Specifications and prices are subject to change without prior notice.



Learn2® Classroom Furniture (Freight Excluded)

LimeLite™ Seating without Worksurface



Learn2® Classroom Furniture (Freight Excluded)

LimeLite™ Seating without Worksurface

MODEL	Features	MODEL NUMBER					Approx. Packaged Weight	Freight Excluded Pricing	Freight Excluded Pricing Fabric Grade 1, C.O.M. & COV	Freight Excluded Pricing Fabric Grade 2	Freight Excluded Pricing Fabric Grade 3 & Group 2V Vinyl	Freight Excluded Pricing Pallas Fabric Group P0	Freight Excluded Pricing Pallas Fabric Group P1	Freight Excluded Pricing Pallas Fabric Group P2	Freight Excluded Pricing Pallas Fabric Group P3	Freight Excluded Pricing Pallas Fabric Group P4
		Basic Model	Frame Color	Shell Color	Glide Option	Uph. Color										
 2LNS1 2LNS2	No Worksurface - Poly Bookbag Rack • One-piece shell • Passive back flex • Poly bookbag rack included • Poly bookbag rack includes two accessory slots and a cupholder • Poly Bookbag rack is only available in black	Polypropylene	<input type="checkbox"/>	<input type="checkbox"/>	<input type="checkbox"/>	49.00#	\$ 716									
		Upholstered Seat	L2LN2/NA/PBR	<input type="checkbox"/>	<input type="checkbox"/>	<input type="checkbox"/>	51.00#	N/A	792	824	841	841	832	882	905	930
 2LNS1 2LNS2	No Worksurface - Flat Accessory Rack • One-piece shell • Passive back flex • Flat accessory rack included	Polypropylene	<input type="checkbox"/>	<input type="checkbox"/>	<input type="checkbox"/>	55.00#	\$ 737									
		Upholstered Seat	L2LN2/NA/FBR	<input type="checkbox"/>	<input type="checkbox"/>	<input type="checkbox"/>	57.00#	N/A	805	838	854	854	846	896	919	944

A **B** **C** **D** **E**

HOW TO ORDER

- Indicate the following information on order form:
- Quantity of each item.
 - Model number, including options. See "How To Build a Model Number".
 - Any special service required.

Note: • The indicates that a choice is required.
 • The absence of the indicates that no choice is required.
 • Alpha-numeric characters in place of indicate that no other alternatives are available.

HOW TO BUILD A MODEL NUMBER

- A** Select basic model.
- B** Select frame color.
Refer to the **Product Color Options** page in this price list.
- C** Select poly seat and back color.
Refer to the **Product Color Options** page in this price list.
- D** Select caster/glide option.

C	- Carpet casters
S	- Hard floor casters
GL	- Glides
SCG	- Front hard floor casters, rear glides
CCG	- Front carpet casters, rear glides
- E** Select upholstery grade/color.
Refer to ki.com/fabrics

UPHOLSTERY INFORMATION

C.O.M. Upholstery
 C.O.M. requirement for 10 chairs or less with upholstered seat or upholstered seat and back is 3/4 yard per chair of 54" wide nondirectional fabric. For orders of 11 or more with upholstered seat and back and for complete information on ordering C.O.M. see "Ordering C.O.M., C.O.V. and C.O.L." section.

FINISH INFORMATION

Poly Bookbag Rack comes standard in Black. Other KI standard poly colors are available through a Product Modification Request. No upcharge or fees apply for orders of 20 or more. A net setup fee applies for orders of 19 or less. Please allow up 1 week additional leadtime.

SPECIAL SERVICES

Special Carton Marking

With specially marked information N/C

Shipping
 Ships **assembled, FOB Green Bay, WI 54302, freight excluded.** Freight class 300.

Specifications and prices are subject to change without prior notice.



Learn2® Classroom Furniture (Freight Excluded)

Strive® Seating without Worksurface



Learn2® Classroom Furniture (Freight Excluded)

Strive® Seating without Worksurface

MODEL	Features	MODEL NUMBER					Approx. Packaged Weight	Freight Excluded Pricing	Freight Excluded Pricing Fabric Grade 1, C.O.M. & COV	Freight Excluded Pricing Fabric Grade 2	Freight Excluded Pricing Fabric Grade 3 & Group 2V Vinyl	Freight Excluded Pricing Pallas Fabric Group P0	Freight Excluded Pricing Pallas Fabric Group P1	Freight Excluded Pricing Pallas Fabric Group P2	Freight Excluded Pricing Pallas Fabric Group P3	Freight Excluded Pricing Pallas Fabric Group P4
		Basic Model	Frame Color	Shell Color	Glide Option	Upholstery Color										
 2SNSP 2SNSU	No Worksurface - Without Accessory Rack	Polypropylene	L2SNP/NA/NAR	<input type="checkbox"/>	<input type="checkbox"/>	<input type="checkbox"/>	44.00#	\$ 658								
		Upholstered Seat	L2SNUS/NA/NAR	<input type="checkbox"/>	<input type="checkbox"/>	<input type="checkbox"/>	47.00#	N/A	730	761	776	769	818	840	865	888
 2SNSP 2SNSU	No Worksurface - Accessory Rack • Accessory rack included on both sides of frame	Polypropylene	L2SNP/NA/SAR	<input type="checkbox"/>	<input type="checkbox"/>	<input type="checkbox"/>	53.00#	\$ 685								
		Upholstered Seat	L2SNUS/NA/SAR	<input type="checkbox"/>	<input type="checkbox"/>	<input type="checkbox"/>	56.00#	N/A	754	790	805	796	846	869	893	916
 2SNSP 2SNSU	No Worksurface - Cup Holder/Accessory Rack • Cup holder/accessory rack included on both sides of frame	Polypropylene	L2SNP/NA/CAR	<input type="checkbox"/>	<input type="checkbox"/>	<input type="checkbox"/>	53.00#	\$ 731								
		Upholstered Seat	L2SNUS/NA/CAR	<input type="checkbox"/>	<input type="checkbox"/>	<input type="checkbox"/>	56.00#	N/A	799	834	849	841	891	916	939	960

A **B** **C** **D** **E**

HOW TO ORDER

- Indicate the following information on order form:
- Quantity of each item.
 - Model number, including options. See "How To Build a Model Number".
 - Any special service required.

Note:

- The indicates that a choice is required.
- The absence of the indicates that no choice is required.
- Alpha-numeric characters in place of indicate that no other alternatives are available.

HOW TO BUILD A MODEL NUMBER

- A** Select basic model.
- B** Select frame color. Refer to the **Product Color Options** page in this price list.
- C** Select poly seat and back color. Refer to the **Product Color Options** page in this price list.
- D** Select caster/glide option.

C	- Carpet casters
S	- Hard floor casters
GL	- Glides
SCG	- Front hard floor casters, rear glides
CCG	- Front carpet casters, rear glides
- E** Select upholstery grade/color. Refer to ki.com/fabrics

UPHOLSTERY INFORMATION

C.O.M. Upholstery
 C.O.M. requirement for 10 chairs or less with upholstered seat or upholstered seat and back is 3/4 yard per chair of 54" wide nondirectional fabric. For orders of 11 or more with upholstered seat and back and for complete information on ordering C.O.M. see "Ordering C.O.M., C.O.V. and C.O.L." section.

SPECIAL SERVICES

Special Carton Marking
 With specially marked information N/C

Shipping
 Ships assembled, FOB Green Bay, WI 54302, freight excluded. Freight class 300.

Specifications and prices are subject to change without prior notice.



Learn2® Classroom Furniture (Freight Excluded)

Strive® Seating without Worksurface



Learn2® Classroom Furniture (Freight Excluded)

Strive® Seating without Worksurface

MODEL	Features	MODEL NUMBER					Approx. Packaged Weight	Freight Excluded Pricing	Freight Excluded Pricing Fabric Grade 1, C.O.M. & COV	Freight Excluded Pricing Fabric Grade 2	Freight Excluded Pricing Fabric Grade 3 & Group 2V Vinyl	Freight Excluded Pricing Pallas Fabric Group P0	Freight Excluded Pricing Pallas Fabric Group P1	Freight Excluded Pricing Pallas Fabric Group P2	Freight Excluded Pricing Pallas Fabric Group P3	Freight Excluded Pricing Pallas Fabric Group P4
		Basic Model	Frame Color	Shell Color	Glide Option	Upholstery Color										
 <p>No Worksurface - Poly Bookbag Rack</p> <ul style="list-style-type: none"> • Poly bookbag rack included • Poly bookbag rack includes two accessory slots and a cupholder • Poly Bookbag rack is only available in black 	Polypropylene	L2SNP/NA/PBR	<input type="checkbox"/>	<input type="checkbox"/>	<input type="checkbox"/>	53.00#	\$ 710									
	Upholstered Seat	L2SNUS/NA/PBR	<input type="checkbox"/>	<input type="checkbox"/>	<input type="checkbox"/>	<input type="checkbox"/>	56.00#	N/A	780	812	826	821	869	891	917	939
2SNSP 2SNSU																
 <p>No Worksurface - Flat Accessory Rack</p> <ul style="list-style-type: none"> • Flat accessory rack included 	Polypropylene	L2SNP/NA/FBR	<input type="checkbox"/>	<input type="checkbox"/>	<input type="checkbox"/>	53.00#	\$ 717									
	Upholstered Seat	L2SNUS/NA/FBR	<input type="checkbox"/>	<input type="checkbox"/>	<input type="checkbox"/>	<input type="checkbox"/>	56.00#	N/A	784	818	833	841	874	898	921	942
2SNSP 2SNSU																

A **B** **C** **D** **E**

HOW TO ORDER

- Indicate the following information on order form:
1. Quantity of each item.
 2. Model number, including options. See "How To Build a Model Number".
 3. Any special service required.

Note:

- The indicates that a choice is required.
- The absence of the indicates that no choice is required.
- Alpha-numeric characters in place of indicate that no other alternatives are available.

HOW TO BUILD A MODEL NUMBER

- A** Select basic model.
- B** Select frame color. Refer to the **Product Color Options** page in this price list.
- C** Select poly seat and back color. Refer to the **Product Color Options** page in this price list.
- D** Select caster/glide option.

C	- Carpet casters
S	- Hard floor casters
GL	- Glides
SCG	- Front hard floor casters, rear glides
CCG	- Front carpet casters, rear glides
- E** Select upholstery grade/color. Refer to ki.com/fabrics

UPHOLSTERY INFORMATION

C.O.M. Upholstery
 C.O.M. requirement for 10 chairs or less with upholstered seat or upholstered seat and back is 3/4 yard per chair of 54" wide nondirectional fabric. For orders of 11 or more with upholstered seat and back and for complete information on ordering C.O.M. see "Ordering C.O.M., C.O.V. and C.O.L." section.

FINISH INFORMATION

Poly Bookbag Rack comes standard in Black. Other KI standard poly colors are available through a Product Modification Request. No upcharge or fees apply for orders of 20 or more. A net setup fee applies for orders of 19 or less. Please allow up 1 week additional leadtime.

SPECIAL SERVICES

Special Carton Marking

With specially marked information N/C

Shipping
 Ships **assembled, FOB Green Bay, WI 54302, freight excluded.** Freight class 300.

Specifications and prices are subject to change without prior notice.



Learn2® Classroom Furniture (Freight Excluded)

Strive® Seating without Worksurface



Learn2® Classroom Furniture (Freight Excluded)

Strive® Seating without Worksurface

MODEL	Features	MODEL NUMBER					Approx. Packaged Weight	Freight Excluded Pricing	Freight Excluded Pricing Fabric Grade 1, C.O.M. & COV	Freight Excluded Pricing Fabric Grade 2	Freight Excluded Pricing Fabric Grade 3 & Group 2V Vinyl	Freight Excluded Pricing Pallas Fabric Group P0	Freight Excluded Pricing Pallas Fabric Group P1	Freight Excluded Pricing Pallas Fabric Group P2	Freight Excluded Pricing Pallas Fabric Group P3	Freight Excluded Pricing Pallas Fabric Group P4
		Basic Model	Frame Color	Shell Color	Glide Option	Upholstery Color										
 No Worksurface - Armchair without Accessory Rack	Polypropylene	L2SNP/CA/NAR	<input type="checkbox"/>	<input type="checkbox"/>	<input type="checkbox"/>	47.00#	\$ 727									
	Upholstered Seat	L2SNUS/CA/NAR	<input type="checkbox"/>	<input type="checkbox"/>	<input type="checkbox"/>	50.00#	N/A	796	830	846	852	900	908	934	954	
2SNSP 2SNSU																
 No Worksurface - Armchair with Accessory Rack • Accessory rack included on both sides of frame	Polypropylene	L2SNP/CA/SAR	<input type="checkbox"/>	<input type="checkbox"/>	<input type="checkbox"/>	56.00#	\$ 753									
	Upholstered Seat	L2SNUS/CA/SAR	<input type="checkbox"/>	<input type="checkbox"/>	<input type="checkbox"/>	59.00#	N/A	825	858	872	865	916	936	964	983	
2SNSP 2SNSU																
 No Worksurface - Armchair with Cup Holder/Accessory Rack • Cup holder/accessory rack included on both sides of frame	Polypropylene	L2SNP/CA/CAR	<input type="checkbox"/>	<input type="checkbox"/>	<input type="checkbox"/>	56.00#	\$ 797									
	Upholstered Seat	L2SNUS/CA/CAR	<input type="checkbox"/>	<input type="checkbox"/>	<input type="checkbox"/>	59.00#	N/A	871	902	919	910	960	983	1008	1027	
2SNSP 2SNSU																

A **B** **C** **D** **E**

HOW TO ORDER

- Indicate the following information on order form:
- Quantity of each item.
 - Model number, including options. See "How To Build a Model Number".
 - Any special service required.

Note: • The indicates that a choice is required.
 • The absence of the indicates that no choice is required.
 • Alpha-numeric characters in place of indicate that no other alternatives are available.

HOW TO BUILD A MODEL NUMBER

- A** Select basic model.
- B** Select frame color.
Refer to the **Product Color Options** page in this price list.
- C** Select poly seat and back color.
Refer to the **Product Color Options** page in this price list.
- D** Select caster/glide option.

C	- Carpet casters
S	- Hard floor casters
GL	- Glides
SCG	- Front hard floor casters, rear glides
CCG	- Front carpet casters, rear glides
- E** Select upholstery grade/color.
Refer to ki.com/fabrics

UPHOLSTERY INFORMATION

C.O.M. Upholstery
 C.O.M. requirement for 10 chairs or less with upholstered seat or upholstered seat and back is 3/4 yard per chair of 54" wide nondirectional fabric. For orders of 11 or more with upholstered seat and back and for complete information on ordering C.O.M. see "Ordering C.O.M., C.O.V. and C.O.L." section.

SPECIAL SERVICES

Special Carton Marking
 With specially marked information N/C

Shipping
 Ships assembled, FOB Green Bay, WI 54302, freight excluded. Freight class 300.

Specifications and prices are subject to change without prior notice.



Learn2® Classroom Furniture (Freight Excluded)

Strive® Seating without Worksurface



Learn2® Classroom Furniture (Freight Excluded)

Strive® Seating without Worksurface

MODEL	Features	MODEL NUMBER					Approx. Packaged Weight	Freight Excluded Pricing	Freight Excluded Pricing Fabric Grade 1, C.O.M. & COV	Freight Excluded Pricing Fabric Grade 2	Freight Excluded Pricing Fabric Grade 3 & Group 2V Vinyl	Freight Excluded Pricing Pallas Fabric Group P0	Freight Excluded Pricing Pallas Fabric Group P1	Freight Excluded Pricing Pallas Fabric Group P2	Freight Excluded Pricing Pallas Fabric Group P3	Freight Excluded Pricing Pallas Fabric Group P4
		Basic Model	Frame Color	Shell Color	Glide Option	Upholstery Color										
 <p>No Worksurface - Armchair with Poly Bookbag Rack</p> <ul style="list-style-type: none"> • Poly bookbag rack included • Poly bookbag rack includes two accessory slots and a cupholder • Poly Bookbag rack is only available in black 	Polypropylene	L2SNP/CA/PBR	<input type="checkbox"/>	<input type="checkbox"/>	<input type="checkbox"/>	56.00#	\$ 778									
	Upholstered Seat	L2SNUS/CA/PBR	<input type="checkbox"/>	<input type="checkbox"/>	<input type="checkbox"/>	59.00#	N/A	847	880	897	903	950	959	985	1005	
2SNSP 2SNSU																
 <p>No Worksurface - Armchair with Flat Accessory Rack</p> <ul style="list-style-type: none"> • Flat accessory rack included 	Polypropylene	L2SNP/CA/FBR	<input type="checkbox"/>	<input type="checkbox"/>	<input type="checkbox"/>	56.00#	\$ 782									
	Upholstered Seat	L2SNUS/CA/FBR	<input type="checkbox"/>	<input type="checkbox"/>	<input type="checkbox"/>	59.00#	N/A	854	885	901	910	942	964	989	1007	
2SNSP 2SNSU																

A **B** **C** **D** **E**

HOW TO ORDER

- Indicate the following information on order form:
1. Quantity of each item.
 2. Model number, including options. See "How To Build a Model Number".
 3. Any special service required.

Note:

- The indicates that a choice is required.
- The absence of the indicates that no choice is required.
- Alpha-numeric characters in place of indicate that no other alternatives are available.

HOW TO BUILD A MODEL NUMBER

- A** Select basic model.
- B** Select frame color. Refer to the **Product Color Options** page in this price list.
- C** Select poly seat and back color. Refer to the **Product Color Options** page in this price list.
- D** Select caster/glide option.

C	- Carpet casters
S	- Hard floor casters
GL	- Glides
SCG	- Front hard floor casters, rear glides
CCG	- Front carpet casters, rear glides
- E** Select upholstery grade/color. Refer to ki.com/fabrics

UPHOLSTERY INFORMATION

C.O.M. Upholstery
 C.O.M. requirement for 10 chairs or less with upholstered seat or upholstered seat and back is 3/4 yard per chair of 54" wide nondirectional fabric. For orders of 11 or more with upholstered seat and back and for complete information on ordering C.O.M. see "Ordering C.O.M., C.O.V. and C.O.L." section.

FINISH INFORMATION

Poly Bookbag Rack comes standard in Black. Other KI standard poly colors are available through a Product Modification Request. No upcharge or fees apply for orders of 20 or more. A net setup fee applies for orders of 19 or less. Please allow up 1 week additional leadtime.



SPECIAL SERVICES

Special Carton Marking
 With specially marked information N/C

Shipping
 Ships **assembled, FOB Green Bay, WI 54302, freight excluded.** Freight class 300.

Specifications and prices are subject to change without prior notice.



Features	MODEL NUMBER									Approx. Packaged Weight	Delivered Pricing Upholstered	Delivered Pricing Fabric Grade 1, C.O.M. & COV	Delivered Pricing Fabric Grade 2	Delivered Pricing Fabric Grade 3 & Group 2V Vinyl	Delivered Pricing Pallas Fabric Group P0	Delivered Pricing Pallas Fabric Group P1	Delivered Pricing Pallas Fabric Group P2	Delivered Pricing Pallas Fabric Group P3	Delivered Pricing Pallas Fabric Group P4	Laminate Grade 2 add to list price		
	Basic Model	Surface Type	Frame Color	Poly Solid Color	Poly Outside/Inside Color	Surface Finish/Plastic Color	GLide Option	Uph. Color														
 <p>2DWS1 2DWS2 2DWSA 2DWSB</p> <p>Without Accessory Rack</p> <ul style="list-style-type: none"> • Non-handed worksurface in choice of plastic or laminate • Solid or two-tone colored shell • Unlimited color match's • 17 degrees of hip articulation 	Solid Color, Polypropylene	L2DT1/NAR	<input type="checkbox"/>	<input type="checkbox"/>	<input type="checkbox"/>		<input type="checkbox"/>	<input type="checkbox"/>		57.00#	\$ 970									\$ 19		
	Solid Color, Upholstered Seat	L2DT2/NAR	<input type="checkbox"/>	<input type="checkbox"/>	<input type="checkbox"/>		<input type="checkbox"/>	<input type="checkbox"/>	<input type="checkbox"/>	57.00#	N/A	1132	1145	1168	1179	1234	1255	1282	1321		19	
	Two-Tone, Polypropylene	L2DTA/NAR	<input type="checkbox"/>	<input type="checkbox"/>		<input type="checkbox"/>	<input type="checkbox"/>	<input type="checkbox"/>		57.00#	1047											19
	Two-Tone, Upholstered Seat	L2DTB/NAR	<input type="checkbox"/>	<input type="checkbox"/>		<input type="checkbox"/>	<input type="checkbox"/>	<input type="checkbox"/>	<input type="checkbox"/>	57.00#	N/A	1209	1220	1244	1255	1311	1332	1360	1398			19
 <p>2DWS1 2DWS2 2DWSA 2DWSB</p> <p>Accessory Rack</p> <ul style="list-style-type: none"> • Non-handed worksurface in choice of plastic or laminate • Accessory rack included on both sides of frame • Solid or two-tone colored shell • Unlimited color match's • 17 degrees of hip articulation 	Solid Color, Polypropylene	L2DT1/SAR	<input type="checkbox"/>	<input type="checkbox"/>	<input type="checkbox"/>		<input type="checkbox"/>	<input type="checkbox"/>		57.00#	\$ 1004										\$ 19	
	Solid Color, Upholstered Seat	L2DT2/SAR	<input type="checkbox"/>	<input type="checkbox"/>	<input type="checkbox"/>		<input type="checkbox"/>	<input type="checkbox"/>	<input type="checkbox"/>	57.00#	N/A	1165	1177	1200	1211	1265	1287	1316	1354			19
	Two-Tone, Polypropylene	L2DTA/SAR	<input type="checkbox"/>	<input type="checkbox"/>		<input type="checkbox"/>	<input type="checkbox"/>	<input type="checkbox"/>		57.00#	1078											19
	Two-Tone, Upholstered Seat	L2DTB/SAR	<input type="checkbox"/>	<input type="checkbox"/>		<input type="checkbox"/>	<input type="checkbox"/>	<input type="checkbox"/>	<input type="checkbox"/>	57.00#	N/A	1239	1253	1275	1287	1342	1363	1392	1429			19

HOW TO ORDER

- Indicate the following information on order form:
- Quantity of each item.
 - Model number, including options. See "How To Build a Model Number".
 - Any special service required.

Note: • The indicates that a choice is required.
 • The absence of the indicates that no choice is required.
 • Alpha-numeric characters in place of indicate that no other alternatives are available.

HOW TO BUILD A MODEL NUMBER

- A** Select basic model.
- B** Select worksurface type.
 LW - Laminate worksurface; add \$68
 PW - Plastic worksurface
- C** Select frame color.
 Refer to the **Product Color Options** page in this price list.
- D** Select solid poly color.
 Refer to the **Product Color Options** page in this price list.
- E** Select outside/inside poly color.
 Refer to the **Product Color Options** page in this price list.
- F** Select surface finish.
 Refer to the **Product Color Options** page in this price list.
- G** Select caster/glide option.

C	- Carpet casters
S	- Hard floor casters
GL	- Glides
SCG	- Front hard floor casters, rear glides
CCG	- Front carpet casters, rear glides

H Select upholstery grade/color.
 Refer to ki.com/fabrics

UPHOLSTERY INFORMATION

C.O.M. Upholstery
 C.O.M. requirement for 10 chairs or less with upholstered seat or upholstered seat and back is 3/4 yard per chair of 54" wide nondirectional fabric. For orders of 11 or more with upholstered seat and back and for complete information on ordering C.O.M. see "Ordering C.O.M., C.O.V. and C.O.L." section.

SPECIAL SERVICES

Special Carton Marking
 With specially marked information N/C

Shipping
 Ships assembled, FOB Green Bay, WI 54302, freight prepaid. Freight class 300.

Specifications and prices are subject to change without prior notice.



Features	MODEL NUMBER								Approx. Packaged Weight	Delivered Pricing Unupholstered	Delivered Pricing Fabric Grade 1, C.O.M. & COV	Delivered Pricing Fabric Grade 2	Delivered Pricing Fabric Grade 3 & Group 2V Vinyl	Delivered Pricing Pallas Fabric Group P0	Delivered Pricing Pallas Fabric Group P1	Delivered Pricing Pallas Fabric Group P2	Delivered Pricing Pallas Fabric Group P3	Delivered Pricing Pallas Fabric Group P4	Laminate Grade 2 add to list price
	Basic Model	Surface Type	Frame Color	Poly Solid Color	Poly Outside/Inside Color	Surface Finish/Plastic Color	Glide Option	Uph. Color											
Solid Color, Polypropylene	L2DT1/FBR	<input type="checkbox"/>	<input type="checkbox"/>	<input type="checkbox"/>		<input type="checkbox"/>	<input type="checkbox"/>		57.00#	\$ 1056									\$ 19
Solid Color, Upholstered Seat	L2DT2/FBR	<input type="checkbox"/>	<input type="checkbox"/>	<input type="checkbox"/>		<input type="checkbox"/>	<input type="checkbox"/>	<input type="checkbox"/>	57.00#	N/A	1217	1228	1252	1263	1318	1340	1366	1406	19
Two-Tone, Polypropylene	L2DTA/FBR	<input type="checkbox"/>	<input type="checkbox"/>		<input type="checkbox"/>	<input type="checkbox"/>	<input type="checkbox"/>		57.00#	1131									19
Two-Tone, Upholstered Seat	L2DTB/FBR	<input type="checkbox"/>	<input type="checkbox"/>		<input type="checkbox"/>	<input type="checkbox"/>	<input type="checkbox"/>	<input type="checkbox"/>	57.00#	N/A	1291	1306	1326	1340	1394	1417	1441	1482	19
2DWS1																			
2DWS2																			
2DWSA																			
2DWSB																			
Flat Accessory Rack																			
• Non-handed worksurface in choice of plastic or laminate																			
• Flat accessory rack included																			
• Solid or two-tone colored shell																			
• Unlimited color match's																			
• 17 degrees of hip articulation																			
	A	B	C	D	E	F	G	H											



- 2DWS1
- 2DWS2
- 2DWSA
- 2DWSB
- Flat Accessory Rack**
- Non-handed worksurface in choice of plastic or laminate
- Flat accessory rack included
- Solid or two-tone colored shell
- Unlimited color match's
- 17 degrees of hip articulation

HOW TO ORDER

- Indicate the following information on order form:
- Quantity of each item.
 - Model number, including options. See "How To Build a Model Number".
 - Any special service required.

Note: • The indicates that a choice is required.
 • The absence of the indicates that no choice is required.
 • Alpha-numeric characters in place of indicate that no other alternatives are available.

HOW TO BUILD A MODEL NUMBER

- A** Select basic model.
- B** Select worksurface type.
 LW - Laminate worksurface; add \$68
 PW - Plastic worksurface
- C** Select frame color.
 Refer to the **Product Color Options** page in this price list.
- D** Select solid poly color.
 Refer to the **Product Color Options** page in this price list.
- E** Select outside/inside poly color.
 Refer to the **Product Color Options** page in this price list.
- F** Select surface finish.
 Refer to the **Product Color Options** page in this price list.
- G** Select caster/glide option.

C	- Carpet casters
S	- Hard floor casters
GL	- Glides
SCG	- Front hard floor casters, rear glides
CCG	- Front carpet casters, rear glides

H Select upholstery grade/color.
 Refer to ki.com/fabrics

UPHOLSTERY INFORMATION

C.O.M. Upholstery
 C.O.M. requirement for 10 chairs or less with upholstered seat or upholstered seat and back is 3/4 yard per chair of 54" wide nondirectional fabric. For orders of 11 or more with upholstered seat and back and for complete information on ordering C.O.M. see "Ordering C.O.M., C.O.V. and C.O.L." section.

SPECIAL SERVICES

Special Carton Marking
 With specially marked information N/C

Shipping
 Ships **assembled, FOB Green Bay, WI 54302, freight prepaid.** Freight class 300.

Specifications and prices are subject to change without prior notice.



Learn2® Classroom Furniture (Delivered)

Intellect Wave® Seating with Worksurface



Learn2® Classroom Furniture (Delivered)

Intellect Wave® Seating with Worksurface

MODEL	Features	MODEL NUMBER							Approx. Packaged Weight	Delivered Pricing	Delivered Pricing Fabric Grade 1, C.O.M. & COV	Delivered Pricing Fabric Grade 2	Delivered Pricing Fabric Grade 3 & Group 2V Vinyl	Delivered Pricing Pallas Fabric Group P0	Delivered Pricing Pallas Fabric Group P1	Delivered Pricing Pallas Fabric Group P2	Delivered Pricing Pallas Fabric Group P3	Delivered Pricing Pallas Fabric Group P4	Laminate Grade 2 add to list price	
		Basic Model	Surface Type	Frame Color	Shell Color	Surface Finish/Plastic Color	Glide Option	Uph. Color												
 2WWSP 2WWSU	Without Accessory Rack • Non-handed worksurface in choice of plastic or laminate	Polypropylene	L2WTP/NAR	<input type="checkbox"/>	<input type="checkbox"/>	<input type="checkbox"/>	<input type="checkbox"/>	<input type="checkbox"/>		37.00#	\$ 749								\$ 19	
		Upholstered Seat	L2WTUS/NAR	<input type="checkbox"/>	<input type="checkbox"/>	<input type="checkbox"/>	<input type="checkbox"/>	<input type="checkbox"/>	<input type="checkbox"/>	<input type="checkbox"/>	40.00#	N/A	823	828	840	828	879	899	918	938
 2WWSP 2WWSU	Accessory Rack • Non-handed worksurface in choice of plastic or laminate • Accessory rack included on both sides of frame	Polypropylene	L2WTP/SAR	<input type="checkbox"/>	<input type="checkbox"/>	<input type="checkbox"/>	<input type="checkbox"/>	<input type="checkbox"/>		46.00#	\$ 777									\$ 19
		Upholstered Seat	L2WTUS/SAR	<input type="checkbox"/>	<input type="checkbox"/>	<input type="checkbox"/>	<input type="checkbox"/>	<input type="checkbox"/>	<input type="checkbox"/>	<input type="checkbox"/>	49.00#	N/A	851	855	870	855	908	927	949	966
 2WWSP 2WWSU	Cup Holder/Accessory Rack • Non-handed worksurface in choice of plastic or laminate • Cup holder/accessory rack included on both sides of frame	Polypropylene	L2WTP/CAR	<input type="checkbox"/>	<input type="checkbox"/>	<input type="checkbox"/>	<input type="checkbox"/>	<input type="checkbox"/>		46.00#	\$ 827									\$ 19
		Upholstered Seat	L2WTUS/CAR	<input type="checkbox"/>	<input type="checkbox"/>	<input type="checkbox"/>	<input type="checkbox"/>	<input type="checkbox"/>	<input type="checkbox"/>	<input type="checkbox"/>	49.00#	N/A	902	906	917	906	957	976	999	1015

A **B** **C** **D** **E** **F** **G**

HOW TO ORDER

- Indicate the following information on order form:
- Quantity of each item.
 - Model number, including options. See "How To Build a Model Number".
 - Any special service required.

Note: • The indicates that a choice is required.
 • The absence of the indicates that no choice is required.
 • Alpha-numeric characters in place of indicate that no other alternatives are available.

HOW TO BUILD A MODEL NUMBER

- A** Select basic model.
- B** Select worksurface type.
 - LW** - Laminate worksurface; add \$68
 - PW** - Plastic worksurface
- C** Select frame color. Refer to the **Product Color Options** page in this price list.
- D** Select shell color. Refer to the **Product Color Options** page in this price list.
- E** Select surface finish. Refer to the **Product Color Options** page in this price list.
- F** Select caster/glide option.
 - C** - Carpet casters
 - S** - Hard floor casters
 - GL** - Glides
 - SCG** - Front hard floor casters, rear

glides
CCG - Front carpet casters, rear glides
G Select upholstery grade/color. Refer to ki.com/fabrics

UPHOLSTERY INFORMATION

C.O.M. Upholstery
 C.O.M. requirement is 5/8 yard per chair for seat of 54" wide nondirectional fabric. For complete information on ordering C.O.M. see "Ordering C.O.M., C.O.V. and C.O.L." section.



SPECIAL SERVICES

Special Carton Marking
 With specially marked information N/C

Shipping
 Ships **assembled, FOB Green Bay, WI 54302, freight prepaid.** Freight class 300.

Specifications and prices are subject to change without prior notice.



MODEL	Features	MODEL NUMBER							Approx. Packaged Weight	Delivered Pricing	Delivered Pricing Fabric Grade 1, C.O.M. & COV	Delivered Pricing Fabric Grade 2	Delivered Pricing Fabric Grade 3 & Group 2V Vinyl	Delivered Pricing Pallas Fabric Group P0	Delivered Pricing Pallas Fabric Group P1	Delivered Pricing Pallas Fabric Group P2	Delivered Pricing Pallas Fabric Group P3	Delivered Pricing Pallas Fabric Group P4	Laminate Grade 2 add to list price
		Basic Model	Surface Type	Frame Color	Shell Color	Surface Finish/Plastic Color	Glide Option	Uph. Color											
 2WWSP 2WWSU	Poly Bookbag Rack • Non-handed worksurface in choice of plastic or laminate • Poly bookbag rack included • Poly bookbag rack includes two accessory slots and a cupholder • Poly Bookbag rack is only available in black	Polypropylene	L2WTP/PBR	<input type="checkbox"/>	<input type="checkbox"/>	<input type="checkbox"/>	<input type="checkbox"/>	<input type="checkbox"/>	46.00#	\$ 854									\$ 19
		Upholstered Seat	L2WTUS/PBR	<input type="checkbox"/>	<input type="checkbox"/>	<input type="checkbox"/>	<input type="checkbox"/>	<input type="checkbox"/>	<input type="checkbox"/>	49.00#	N/A	931	939	952	939	992	1014	1035	1056
 2WWSP 2WWSU	Flat Accessory Rack • Non-handed worksurface in choice of plastic or laminate • Flat accessory rack included	Polypropylene	L2WTP/FBR	<input type="checkbox"/>	<input type="checkbox"/>	<input type="checkbox"/>	<input type="checkbox"/>	<input type="checkbox"/>	46.00#	\$ 827									\$ 19
		Upholstered Seat	L2WTUS/FBR	<input type="checkbox"/>	<input type="checkbox"/>	<input type="checkbox"/>	<input type="checkbox"/>	<input type="checkbox"/>	<input type="checkbox"/>	49.00#	N/A	902	906	917	906	957	976	999	1015
				A	B	C	D	E	F	G									

HOW TO ORDER

- Indicate the following information on order form:
- Quantity of each item.
 - Model number, including options. See "How To Build a Model Number".
 - Any special service required.

Note: • The indicates that a choice is required.
 • The absence of the indicates that no choice is required.
 • Alpha-numeric characters in place of indicate that no other alternatives are available.

HOW TO BUILD A MODEL NUMBER

- A** Select basic model.
- B** Select worksurface type.
 - LW** - Laminate worksurface; add \$68
 - PW** - Plastic worksurface
- C** Select frame color. Refer to the **Product Color Options** page in this price list.
- D** Select shell color. Refer to the **Product Color Options** page in this price list.
- E** Select surface finish. Refer to the **Product Color Options** page in this price list.
- F** Select caster/glide option.
 - C** - Carpet casters
 - S** - Hard floor casters
 - GL** - Glides
 - SCG** - Front hard floor casters, rear glides

CCG - Front carpet casters, rear glides

G Select upholstery grade/color. Refer to ki.com/fabrics

UPHOLSTERY INFORMATION

C.O.M. Upholstery
 C.O.M. requirement is 5/8 yard per chair for seat of 54" wide nondirectional fabric. For complete information on ordering C.O.M. see "Ordering C.O.M., C.O.V. and C.O.L." section.

FINISH INFORMATION

Poly Bookbag Rack comes standard in Black. Other KI standard poly colors are available through a Product Modification Request. No upcharge or fees apply for orders of 20 or more. A net setup fee applies for orders of 19 or less. Please allow up 1 week additional leadtime.

SPECIAL SERVICES

Special Carton Marking



With specially marked information N/C

Shipping

Ships assembled, FOB Green Bay, WI 54302, freight prepaid. Freight class 300.

Specifications and prices are subject to change without prior notice.



MODEL	Features	MODEL NUMBER							Approx. Packaged Weight	Delivered Pricing	Delivered Pricing Fabric Grade 1, C.O.M. & COV	Delivered Pricing Fabric Grade 2	Delivered Pricing Fabric Grade 3 & Group 2V Vinyl	Delivered Pricing Vinyl Group 2V	Delivered Pricing Pallas Fabric Group P0	Delivered Pricing Pallas Fabric Group P1	Delivered Pricing Pallas Fabric Group P2	Delivered Pricing Pallas Fabric Group P3	Delivered Pricing Pallas Fabric Group P4	Laminate Grade 2 add to list price	
		Basic Model	Surface Type	Frame Color	Shell Color	Surface Finish/Plastic Color	Glide Option	Uph. Color													
 Without Accessory Rack • One-piece shell • Passive back flex • Non-handed worksurface in choice of plastic or laminate	Polypropylene	L2LT1/NA/NAR	<input type="checkbox"/>	<input type="checkbox"/>	<input type="checkbox"/>	<input type="checkbox"/>	<input type="checkbox"/>	<input type="checkbox"/>	47.00#	\$ 912										\$ 19	
	Upholstered Seat	L2LT2/NA/NAR	<input type="checkbox"/>	<input type="checkbox"/>	<input type="checkbox"/>	<input type="checkbox"/>	<input type="checkbox"/>	<input type="checkbox"/>	<input type="checkbox"/>	49.00#	N/A	991	1025	1043	1043	1033	1087	1111	1139	1162	19
2LWS1 2LWS2																					
 Accessory Rack • One-piece shell • Passive back flex • Non-handed worksurface in choice of plastic or laminate • Accessory rack included on both sides of frame	Polypropylene	L2LT1/NA/SAR	<input type="checkbox"/>	<input type="checkbox"/>	<input type="checkbox"/>	<input type="checkbox"/>	<input type="checkbox"/>	<input type="checkbox"/>	55.00#	\$ 942										\$ 19	
	Upholstered Seat	L2LT2/NA/SAR	<input type="checkbox"/>	<input type="checkbox"/>	<input type="checkbox"/>	<input type="checkbox"/>	<input type="checkbox"/>	<input type="checkbox"/>	<input type="checkbox"/>	57.00#	N/A	1022	1056	1074	1074	1064	1118	1142	1170	1193	19
2LWS1 2LWS2																					
 Cup Holder/Accessory Rack • One-piece shell • Passive back flex • Non-handed worksurface in choice of plastic or laminate • Cup holder/accessory rack included on both sides of frame	Polypropylene	L2LT1/NA/CAR	<input type="checkbox"/>	<input type="checkbox"/>	<input type="checkbox"/>	<input type="checkbox"/>	<input type="checkbox"/>	<input type="checkbox"/>	55.00#	\$ 992										\$ 19	
	Upholstered Seat	L2LT2/NA/CAR	<input type="checkbox"/>	<input type="checkbox"/>	<input type="checkbox"/>	<input type="checkbox"/>	<input type="checkbox"/>	<input type="checkbox"/>	<input type="checkbox"/>	57.00#	N/A	1070	1104	1122	1122	1112	1166	1190	1218	1241	19
2LWS1 2LWS2																					

A **B** **C** **D** **E** **F** **G**

HOW TO ORDER

- Indicate the following information on order form:
- Quantity of each item.
 - Model number, including options. See "How To Build a Model Number".
 - Any special service required.

Note: • The indicates that a choice is required.
 • The absence of the indicates that no choice is required.
 • Alpha-numeric characters in place of indicate that no other alternatives are available.

HOW TO BUILD A MODEL NUMBER

- A** Select basic model.
- B** Select worksurface type.
 LW - Laminate worksurface; add \$68
 PW - Plastic worksurface
- C** Select frame color.
 Refer to the **Product Color Options** page in this price list.
- D** Select poly seat and back color.
 Refer to the **Product Color Options** page in this price list.
- E** Select surface finish.
 Refer to the **Product Color Options** page in this price list.
- F** Select caster/glide option.
 C - Carpet casters
 S - Hard floor casters
 GL - Glides
 SCG - Front hard floor casters, rear

- glides
 CCG - Front carpet casters, rear glides
- G** Select upholstery grade/color.
 Refer to ki.com/fabrics

UPHOLSTERY INFORMATION

C.O.M. Upholstery
 C.O.M. requirement for 10 chairs or less with upholstered seat or upholstered seat and back is 3/4 yard per chair of 54" wide nondirectional fabric. For orders of 11 or more with upholstered seat and back and for complete information on ordering C.O.M. see "Ordering C.O.M., C.O.V. and C.O.L." section.

SPECIAL SERVICES

Special Carton Marking



With specially marked information N/C

Shipping

Ships assembled, FOB Green Bay, WI 54302, freight prepaid. Freight class 300.

Specifications and prices are subject to change without prior notice.



MODEL	Features	MODEL NUMBER							Approx. Packaged Weight	Delivered Pricing	Delivered Pricing Fabric Grade 1, C.O.M. & COV	Delivered Pricing Fabric Grade 2	Delivered Pricing Fabric Grade 3 & Group 2V Vinyl	Delivered Pricing Vinyl Group 2V	Delivered Pricing Pallas Fabric Group P0	Delivered Pricing Pallas Fabric Group P1	Delivered Pricing Pallas Fabric Group P2	Delivered Pricing Pallas Fabric Group P3	Delivered Pricing Pallas Fabric Group P4	Laminate Grade 2 add to list price
		Basic Model	Surface Type	Frame Color	Shell Color	Surface Finish/Plastic Color	Glide Option	Uph. Color												
 2LWS1 2LWS2	Poly Bookbag Rack • One-piece shell • Passive back flex • Non-handed worksurface in choice of plastic or laminate • Poly bookbag rack included • Poly bookbag rack includes two accessory slots and a cupholder • Poly Bookbag rack is only available in black	Polypropylene	L2LT1/NA/PBR	<input type="checkbox"/>	<input type="checkbox"/>	<input type="checkbox"/>	<input type="checkbox"/>	<input type="checkbox"/>	51.00#	\$ 982										\$ 19
	Upholstered Seat	L2LT2/NA/PBR	<input type="checkbox"/>	<input type="checkbox"/>	<input type="checkbox"/>	<input type="checkbox"/>	<input type="checkbox"/>	<input type="checkbox"/>	53.00#	N/A	1052	1086	1104	1104	1095	1149	1173	1201	1224	19
 2LWS1 2LWS2	Flat Accessory Rack • One-piece shell • Passive back flex • Non-handed worksurface in choice of plastic or laminate • Flat accessory rack included	Polypropylene	L2LT1/NA/FBR	<input type="checkbox"/>	<input type="checkbox"/>	<input type="checkbox"/>	<input type="checkbox"/>	<input type="checkbox"/>	57.00#	\$ 992										\$ 19
	Upholstered Seat	L2LT2/NA/FBR	<input type="checkbox"/>	<input type="checkbox"/>	<input type="checkbox"/>	<input type="checkbox"/>	<input type="checkbox"/>	<input type="checkbox"/>	59.00#	N/A	1070	1104	1122	1122	1112	1166	1190	1218	1241	19

A **B** **C** **D** **E** **F** **G**

HOW TO ORDER

- Indicate the following information on order form:
- Quantity of each item.
 - Model number, including options. See "How To Build a Model Number".
 - Any special service required.

Note:

- The indicates that a choice is required.
- The absence of the indicates that no choice is required.
- Alpha-numeric characters in place of indicate that no other alternatives are available.

HOW TO BUILD A MODEL NUMBER

- A** Select basic model.
- B** Select worksurface type.
 - LW** - Laminate worksurface; add \$68
 - PW** - Plastic worksurface
- C** Select frame color. Refer to the **Product Color Options** page in this price list.
- D** Select poly seat and back color. Refer to the **Product Color Options** page in this price list.
- E** Select surface finish. Refer to the **Product Color Options** page in this price list.
- F** Select caster/glide option.
 - C** - Carpet casters
 - S** - Hard floor casters
 - GL** - Glides
 - SCG** - Front hard floor casters, rear

glides
CCG - Front carpet casters, rear glides
G Select upholstery grade/color. Refer to ki.com/fabrics

UPHOLSTERY INFORMATION

C.O.M. Upholstery
 C.O.M. requirement for 10 chairs or less with upholstered seat or upholstered seat and back is 3/4 yard per chair of 54" wide nondirectional fabric. For orders of 11 or more with upholstered seat and back and for complete information on ordering C.O.M. see "Ordering C.O.M., C.O.V. and C.O.L." section.

FINISH INFORMATION

Poly Bookbag Rack comes standard in Black. Other KI standard poly colors are available through a Product Modification Request. No upcharge or fees apply for orders of 20 or more. A net setup fee applies for orders of 19 or less. Please allow up 1 week additional leadtime.

SPECIAL SERVICES

Special Carton Marking



With specially marked information N/C

Shipping

Ships **assembled, FOB Green Bay, WI 54302, freight prepaid.** Freight class 300.

Specifications and prices are subject to change without prior notice.



MODEL	Features	MODEL NUMBER							Approx. Packaged Weight	Delivered Pricing	Delivered Pricing Fabric Grade 1, C.O.M. & COV	Delivered Pricing Fabric Grade 2	Delivered Pricing Fabric Grade 3 & Group 2V Vinyl	Delivered Pricing Pallas Fabric Group P0	Delivered Pricing Pallas Fabric Group P1	Delivered Pricing Pallas Fabric Group P2	Delivered Pricing Pallas Fabric Group P3	Delivered Pricing Pallas Fabric Group P4	Laminate Grade 2 add to list price
		Basic Model	Surface Type	Frame Color	Shell Color	Surface Finish/Plastic Color	Glide Option	Uph. Color											
 Without Accessory Rack • Non-handed worksurface in choice of plastic or laminate	Polypropylene	L2STP/NA/NAR	<input type="checkbox"/>	<input type="checkbox"/>	<input type="checkbox"/>	<input type="checkbox"/>	<input type="checkbox"/>	<input type="checkbox"/>	48.00#	\$ 905									\$ 19
	Upholstered Seat	L2STUS/NA/NAR	<input type="checkbox"/>	<input type="checkbox"/>	<input type="checkbox"/>	<input type="checkbox"/>	<input type="checkbox"/>	<input type="checkbox"/>	51.00#	N/A	984	1021	1037	1029	1083	1107	1135	1158	19
 Accessory Rack • Non-handed worksurface in choice of plastic or laminate • Accessory rack included on both sides of frame	Polypropylene	L2STP/NA/SAR	<input type="checkbox"/>	<input type="checkbox"/>	<input type="checkbox"/>	<input type="checkbox"/>	<input type="checkbox"/>	<input type="checkbox"/>	57.00#	\$ 935									\$ 19
	Upholstered Seat	L2STUS/NA/SAR	<input type="checkbox"/>	<input type="checkbox"/>	<input type="checkbox"/>	<input type="checkbox"/>	<input type="checkbox"/>	<input type="checkbox"/>	60.00#	N/A	1016	1052	1066	1060	1111	1137	1165	1188	19
 Cup Holder/Accessory Rack • Non-handed worksurface in choice of plastic or laminate • Cup holder/accessory rack included on both sides of frame	Polypropylene	L2STP/NA/CAR	<input type="checkbox"/>	<input type="checkbox"/>	<input type="checkbox"/>	<input type="checkbox"/>	<input type="checkbox"/>	<input type="checkbox"/>	57.00#	\$ 985									\$ 19
	Upholstered Seat	L2STUS/NA/CAR	<input type="checkbox"/>	<input type="checkbox"/>	<input type="checkbox"/>	<input type="checkbox"/>	<input type="checkbox"/>	<input type="checkbox"/>	60.00#	N/A	1063	1102	1115	1109	1163	1188	1215	1237	19

A **B** **C** **D** **E** **F** **G**

HOW TO ORDER

- Indicate the following information on order form:
- Quantity of each item.
 - Model number, including options. See "How To Build a Model Number".
 - Any special service required.

Note: • The indicates that a choice is required.
 • The absence of the indicates that no choice is required.
 • Alpha-numeric characters in place of indicate that no other alternatives are available.

HOW TO BUILD A MODEL NUMBER

- A** Select basic model.
- B** Select worksurface type.
 LW - Laminate worksurface; add \$68
 PW - Plastic worksurface
- C** Select frame color.
 Refer to the **Product Color Options** page in this price list.
- D** Select poly seat and back color.
 Refer to the **Product Color Options** page in this price list.
- E** Select surface finish.
 Refer to the **Product Color Options** page in this price list.
- F** Select caster/glide option.
 C - Carpet casters
 S - Hard floor casters
 GL - Glides
 SCG - Front hard floor casters, rear

glides
CCG - Front carpet casters, rear glides

G Select upholstery grade/color.
 Refer to ki.com/fabrics

UPHOLSTERY INFORMATION

C.O.M. Upholstery
 C.O.M. requirement for 10 chairs or less with upholstered seat or upholstered seat and back is 3/4 yard per chair of 54" wide nondirectional fabric. For orders of 11 or more with upholstered seat and back and for complete information on ordering C.O.M. see "Ordering C.O.M., C.O.V. and C.O.L." section.



SPECIAL SERVICES

Special Carton Marking
 With specially marked information N/C

Shipping
 Ships assembled, FOB Green Bay, WI 54302, freight prepaid. Freight class 300.

Specifications and prices are subject to change without prior notice.



MODEL	Features	MODEL NUMBER							Approx. Packaged Weight	Delivered Pricing	Delivered Pricing Fabric Grade 1, C.O.M. & COV	Delivered Pricing Fabric Grade 2	Delivered Pricing Fabric Grade 3 & Group 2V Vinyl	Delivered Pricing Pallas Fabric Group P0	Delivered Pricing Pallas Fabric Group P1	Delivered Pricing Pallas Fabric Group P2	Delivered Pricing Pallas Fabric Group P3	Delivered Pricing Pallas Fabric Group P4	Laminate Grade 2 add to list price
		Basic Model	Surface Type	Frame Color	Shell Color	Surface Finish/Plastic Color	Glide Option	Uph. Color											
 Poly Bookbag Rack • Non-handed worksurface in choice of plastic or laminate • Poly bookbag rack included • Poly bookbag rack includes two accessory slots and a cupholder • Poly Bookbag rack is only available in black	Polypropylene	L2STP/NA/PBR	<input type="checkbox"/>	<input type="checkbox"/>	<input type="checkbox"/>	<input type="checkbox"/>	<input type="checkbox"/>	<input type="checkbox"/>	57.00#	\$ 1014									\$ 19
	Upholstered Seat	L2STUS/NA/PBR	<input type="checkbox"/>	<input type="checkbox"/>	<input type="checkbox"/>	<input type="checkbox"/>	<input type="checkbox"/>	<input type="checkbox"/>	60.00#	N/A	1086	1122	1140	1130	1187	1211	1240	1264	19
2SWSP 2SWSU																			
 Flat Accessory Rack • Non-handed worksurface in choice of plastic or laminate • Flat accessory rack included	Polypropylene	L2STP/NA/FBR	<input type="checkbox"/>	<input type="checkbox"/>	<input type="checkbox"/>	<input type="checkbox"/>	<input type="checkbox"/>	<input type="checkbox"/>	57.00#	\$ 985									\$ 19
	Upholstered Seat	L2STUS/NA/FBR	<input type="checkbox"/>	<input type="checkbox"/>	<input type="checkbox"/>	<input type="checkbox"/>	<input type="checkbox"/>	<input type="checkbox"/>	60.00#	N/A	1063	1102	1115	1109	1163	1188	1215	1237	19
2SWSP 2SWSU																			

A **B** **C** **D** **E** **F** **G**

HOW TO ORDER

- Indicate the following information on order form:
- Quantity of each item.
 - Model number, including options. See "How To Build a Model Number".
 - Any special service required.

Note:

- The indicates that a choice is required.
- The absence of the indicates that no choice is required.
- Alpha-numeric characters in place of indicate that no other alternatives are available.

HOW TO BUILD A MODEL NUMBER

- A** Select basic model.
- B** Select worksurface type.
 - LW** - Laminate worksurface; add \$68
 - PW** - Plastic worksurface
- C** Select frame color. Refer to the **Product Color Options** page in this price list.
- D** Select poly seat and back color. Refer to the **Product Color Options** page in this price list.
- E** Select surface finish. Refer to the **Product Color Options** page in this price list.
- F** Select caster/glide option.
 - C** - Carpet casters
 - S** - Hard floor casters
 - GL** - Glides
 - SCG** - Front hard floor casters, rear

glides
CCG - Front carpet casters, rear glides

G Select upholstery grade/color. Refer to ki.com/fabrics

UPHOLSTERY INFORMATION

C.O.M. Upholstery
C.O.M. requirement for 10 chairs or less with upholstered seat or upholstered seat and back is 3/4 yard per chair of 54" wide nondirectional fabric. For orders of 11 or more with upholstered seat and back and for complete information on ordering C.O.M. see "Ordering C.O.M., C.O.V. and C.O.L." section.

FINISH INFORMATION

Poly Bookbag Rack comes standard in Black. Other KI standard poly colors are available through a Product Modification Request. No upcharge or fees apply for orders of 20 or more. A net setup fee applies for orders of 19 or less. Please allow up 1 week additional leadtime.

SPECIAL SERVICES

Special Carton Marking



With specially marked information N/C

Shipping

Ships **assembled, FOB Green Bay, WI 54302, freight prepaid.** Freight class 300.

Specifications and prices are subject to change without prior notice.



MODEL	Features	MODEL NUMBER							Approx. Packaged Weight	Delivered Pricing	Delivered Pricing Fabric Grade 1, C.O.M. & COV	Delivered Pricing Fabric Grade 2	Delivered Pricing Fabric Grade 3 & Group 2V Vinyl	Delivered Pricing Pallas Fabric Group P0	Delivered Pricing Pallas Fabric Group P1	Delivered Pricing Pallas Fabric Group P2	Delivered Pricing Pallas Fabric Group P3	Delivered Pricing Pallas Fabric Group P4	Laminate Grade 2 add to list price
		Basic Model	Surface Type	Frame Color	Shell Color	Surface Finish/Plastic Color	Glide Option	Uph. Color											
 2SWSP 2SWSU	Armchair without Accessory Rack • Non-handed worksurface in choice of plastic or laminate	Polypropylene	L2STP/CA/NAR	<input type="checkbox"/>	<input type="checkbox"/>	<input type="checkbox"/>	<input type="checkbox"/>	<input type="checkbox"/>	51.00#	\$ 982									\$ 19
		Upholstered Seat	L2STUS/CA/NAR	<input type="checkbox"/>	<input type="checkbox"/>	<input type="checkbox"/>	<input type="checkbox"/>	<input type="checkbox"/>	<input type="checkbox"/>	54.00#	N/A	1060	1095	1111	1105	1158	1184	1211	1233
 2SWSP 2SWSU	Armchair with Accessory Rack • Non-handed worksurface in choice of plastic or laminate • Accessory rack included on both sides of frame	Polypropylene	L2STP/CA/SAR	<input type="checkbox"/>	<input type="checkbox"/>	<input type="checkbox"/>	<input type="checkbox"/>	<input type="checkbox"/>	60.00#	\$ 1010									\$ 19
		Upholstered Seat	L2STUS/CA/SAR	<input type="checkbox"/>	<input type="checkbox"/>	<input type="checkbox"/>	<input type="checkbox"/>	<input type="checkbox"/>	<input type="checkbox"/>	63.00#	N/A	1090	1127	1142	1135	1188	1214	1241	1263
 2SWSP 2SWSU	Armchair with Cup Holder/Accessory Rack • Non-handed worksurface in choice of plastic or laminate • Cup holder/accessory rack included on both sides of frame	Polypropylene	L2STP/CA/CAR	<input type="checkbox"/>	<input type="checkbox"/>	<input type="checkbox"/>	<input type="checkbox"/>	<input type="checkbox"/>	60.00#	\$ 1061									\$ 19
		Upholstered Seat	L2STUS/CA/CAR	<input type="checkbox"/>	<input type="checkbox"/>	<input type="checkbox"/>	<input type="checkbox"/>	<input type="checkbox"/>	<input type="checkbox"/>	63.00#	N/A	1138	1175	1192	1185	1237	1263	1291	1313

A **B** **C** **D** **E** **F** **G**

HOW TO ORDER

- Indicate the following information on order form:
- Quantity of each item.
 - Model number, including options. See "How To Build a Model Number".
 - Any special service required.

Note:

- The indicates that a choice is required.
- The absence of the indicates that no choice is required.
- Alpha-numeric characters in place of indicate that no other alternatives are available.

HOW TO BUILD A MODEL NUMBER

- A** Select basic model.
- B** Select worksurface type.
 - LW** - Laminate worksurface; add \$68
 - PW** - Plastic worksurface
- C** Select frame color. Refer to the **Product Color Options** page in this price list.
- D** Select poly seat and back color. Refer to the **Product Color Options** page in this price list.
- E** Select surface finish. Refer to the **Product Color Options** page in this price list.
- F** Select caster/glide option.
 - C** - Carpet casters
 - S** - Hard floor casters
 - GL** - Glides
 - SCG** - Front hard floor casters, rear

glides
CCG - Front carpet casters, rear glides

G Select upholstery grade/color. Refer to ki.com/fabrics

UPHOLSTERY INFORMATION

C.O.M. Upholstery
 C.O.M. requirement for 10 chairs or less with upholstered seat or upholstered seat and back is 3/4 yard per chair of 54" wide nondirectional fabric. For orders of 11 or more with upholstered seat and back and for complete information on ordering C.O.M. see "Ordering C.O.M., C.O.V. and C.O.L." section.



SPECIAL SERVICES

Special Carton Marking
 With specially marked information N/C

Shipping
 Ships **assembled, FOB Green Bay, WI 54302, freight prepaid.** Freight class 300.

Specifications and prices are subject to change without prior notice.



MODEL	Features	MODEL NUMBER							Approx. Packaged Weight	Delivered Pricing	Delivered Pricing Fabric Grade 1, C.O.M. & COV	Delivered Pricing Fabric Grade 2	Delivered Pricing Fabric Grade 3 & Group 2V Vinyl	Delivered Pricing Pallas Fabric Group P0	Delivered Pricing Pallas Fabric Group P1	Delivered Pricing Pallas Fabric Group P2	Delivered Pricing Pallas Fabric Group P3	Delivered Pricing Pallas Fabric Group P4	Laminate Grade 2 add to list price
		Basic Model	Surface Type	Frame Color	Shell Color	Surface Finish/Plastic Color	Glide Option	Uph. Color											
 <p>Armchair with Poly Bookbag Rack</p> <ul style="list-style-type: none"> • Non-handed worksurface in choice of plastic or laminate • Poly bookbag rack included • Poly bookbag rack includes two accessory slots and a cupholder • Poly Bookbag rack is only available in black 	Polypropylene	L2STP/CA/PBR	<input type="checkbox"/>	<input type="checkbox"/>	<input type="checkbox"/>	<input type="checkbox"/>	<input type="checkbox"/>	60.00#	\$ 1080										\$ 19
	Upholstered Seat	L2STUS/CA/PBR	<input type="checkbox"/>	<input type="checkbox"/>	<input type="checkbox"/>	<input type="checkbox"/>	<input type="checkbox"/>	63.00#	N/A	1163	1200	1217	1209	1264	1290	1319	1342	19	
2SWSP 2SWSU																			
 <p>Armchair with Flat Accessory Rack</p> <ul style="list-style-type: none"> • Non-handed worksurface in choice of plastic or laminate • Flat accessory rack included 	Polypropylene	L2STP/CA/FBR	<input type="checkbox"/>	<input type="checkbox"/>	<input type="checkbox"/>	<input type="checkbox"/>	<input type="checkbox"/>	60.00#	\$ 1061										\$ 19
	Upholstered Seat	L2STUS/CA/FBR	<input type="checkbox"/>	<input type="checkbox"/>	<input type="checkbox"/>	<input type="checkbox"/>	<input type="checkbox"/>	63.00#	N/A	1138	1175	1192	1185	1237	1263	1291	1313	19	
2SWSP 2SWSU																			

A **B** **C** **D** **E** **F** **G**

HOW TO ORDER

- Indicate the following information on order form:
- Quantity of each item.
 - Model number, including options. See "How To Build a Model Number".
 - Any special service required.

Note:

- The indicates that a choice is required.
- The absence of the indicates that no choice is required.
- Alpha-numeric characters in place of indicate that no other alternatives are available.

HOW TO BUILD A MODEL NUMBER

- A** Select basic model.
- B** Select worksurface type.
 - LW** - Laminate worksurface; add \$68
 - PW** - Plastic worksurface
- C** Select frame color. Refer to the **Product Color Options** page in this price list.
- D** Select poly seat and back color. Refer to the **Product Color Options** page in this price list.
- E** Select surface finish. Refer to the **Product Color Options** page in this price list.
- F** Select caster/glide option.
 - C** - Carpet casters
 - S** - Hard floor casters
 - GL** - Glides
 - SCG** - Front hard floor casters, rear

- G** Select upholstery grade/color. Refer to ki.com/fabrics

UPHOLSTERY INFORMATION

C.O.M. Upholstery
 C.O.M. requirement for 10 chairs or less with upholstered seat or upholstered seat and back is 3/4 yard per chair of 54" wide nondirectional fabric. For orders of 11 or more with upholstered seat and back and for complete information on ordering C.O.M. see "Ordering C.O.M., C.O.V. and C.O.L." section.

FINISH INFORMATION

Poly Bookbag Rack comes standard in Black. Other KI standard poly colors are available through a Product Modification Request. No upcharge or fees apply for orders of 20 or more. A net setup fee applies for orders of 19 or less. Please allow up 1 week additional leadtime.

SPECIAL SERVICES

Special Carton Marking

With specially marked information N/C

Shipping

Ships assembled, FOB Green Bay, WI 54302, freight prepaid. Freight class 300.

Specifications and prices are subject to change without prior notice.



Learn2® Classroom Furniture (Delivered)

Doni® Seating without Worksurface



Learn2® Classroom Furniture (Delivered)

Doni® Seating without Worksurface

MODEL	Features	MODEL NUMBER						Approx. Packaged Weight	Delivered Pricing Unupholstered	Delivered Pricing Fabric Grade 1, C.O.M. & COV	Delivered Pricing Fabric Grade 2	Delivered Pricing Fabric Grade 3 & Group 2V Vinyl	Delivered Pricing Pallas Fabric Group P0	Delivered Pricing Pallas Fabric Group P1	Delivered Pricing Pallas Fabric Group P2	Delivered Pricing Pallas Fabric Group P3	Delivered Pricing Pallas Fabric Group P4
		Basic Model	Frame Color	Poly Solid Color	Poly Outside/Inside Color	Glide Option	Uph. Color										
 <p>No Worksurface - Without Accessory Rack</p> <ul style="list-style-type: none"> Solid or two-tone colored shell Unlimited color match's 17 degrees of hip articulation 	Solid Color, Polypropylene	L2DN1/NAR	<input type="checkbox"/>	<input type="checkbox"/>		<input type="checkbox"/>	57.00#	\$ 776									
	Solid Color, Upholstered Seat	L2DN2/NAR	<input type="checkbox"/>	<input type="checkbox"/>		<input type="checkbox"/>	57.00#	N/A	939	953	972	985	1043	1062	1090	1130	
	Two-Tone, Polypropylene	L2DNA/NAR	<input type="checkbox"/>		<input type="checkbox"/>	<input type="checkbox"/>	57.00#	854									
	Two-Tone, Upholstered Seat	L2DNB/NAR	<input type="checkbox"/>		<input type="checkbox"/>	<input type="checkbox"/>	57.00#	N/A	1015	1026	1049	1062	1116	1137	1167	1207	
2DNS1 2DNS2 2DNSA 2DNSB																	
 <p>No Worksurface - Accessory Rack</p> <ul style="list-style-type: none"> Accessory rack included on both sides of frame Solid or two-tone colored shell Unlimited color match's 17 degrees of hip articulation 	Solid Color, Polypropylene	L2DN1/SAR	<input type="checkbox"/>	<input type="checkbox"/>		<input type="checkbox"/>	57.00#	\$ 810									
	Solid Color, Upholstered Seat	L2DN2/SAR	<input type="checkbox"/>	<input type="checkbox"/>		<input type="checkbox"/>	57.00#	N/A	970	983	1006	1018	1072	1095	1122	1163	
	Two-Tone, Polypropylene	L2DNA/SAR	<input type="checkbox"/>		<input type="checkbox"/>	<input type="checkbox"/>	57.00#	885									
	Two-Tone, Upholstered Seat	L2DNB/SAR	<input type="checkbox"/>		<input type="checkbox"/>	<input type="checkbox"/>	57.00#	N/A	1047	1060	1080	1095	1149	1171	1199	1236	
2DNS1 2DNS2 2DNSA 2DNSB																	
			A	B	C	D	E	F									

HOW TO ORDER

- Indicate the following information on order form:
- Quantity of each item.
 - Model number, including options. See "How To Build a Model Number".
 - Any special service required.

Note:

- The indicates that a choice is required.
- The absence of the indicates that no choice is required.
- Alpha-numeric characters in place of indicate that no other alternatives are available.

HOW TO BUILD A MODEL NUMBER

Refer to ki.com/fabrics

- A** Select basic model.
- B** Select frame color.
Refer to the **Product Color Options** page in this price list.
- C** Select solid poly color.
Refer to the **Product Color Options** page in this price list.
- D** Select outside/inside poly color.
Refer to the **Product Color Options** page in this price list.
- E** Select caster/glide option.
 - C** - Carpet casters
 - S** - Hard floor casters
 - GL** - Glides
 - SCG** - Front hard floor casters, rear glides
 - CCG** - Front carpet casters, rear glides
- F** Select upholstery grade/color.

UPHOLSTERY INFORMATION

C.O.M. Upholstery
C.O.M. requirement for 10 chairs or less with upholstered seat or upholstered seat and back is 3/4 yard per chair of 54" wide nondirectional fabric. For orders of 11 or more with upholstered seat and back and for complete information on ordering C.O.M. see "Ordering C.O.M., C.O.V. and C.O.L." section.

SPECIAL SERVICES

Special Carton Marking

With specially marked information N/C

Shipping

Ships assembled, FOB Green Bay, WI 54302, freight prepaid. Freight class 300.

Specifications and prices are subject to change without prior notice.



MODEL	Features	MODEL NUMBER						Approx. Packaged Weight	Delivered Pricing Unupholstered	Delivered Pricing Fabric Grade 1, C.O.M. & COV	Delivered Pricing Fabric Grade 2	Delivered Pricing Fabric Grade 3 & Group 2V Vinyl	Delivered Pricing Pallas Fabric Group P0	Delivered Pricing Pallas Fabric Group P1	Delivered Pricing Pallas Fabric Group P2	Delivered Pricing Pallas Fabric Group P3	Delivered Pricing Pallas Fabric Group P4
		Basic Model	Frame Color	Poly Solid Color	Poly Outside/Inside Color	Glide Option	Uph. Color										
 <p>No Worksurface - Cup Holder/Accessory Rack</p> <ul style="list-style-type: none"> Cup holder/accessory rack included on both sides of frame Solid or two-tone colored shell Unlimited color match's 17 degrees of hip articulation 	Solid Color, Polypropylene	L2DN1/CAR	<input type="checkbox"/>	<input type="checkbox"/>		<input type="checkbox"/>	57.00#	\$ 860									
	Solid Color, Upholstered Seat	L2DN2/CAR	<input type="checkbox"/>	<input type="checkbox"/>		<input type="checkbox"/>	57.00#	N/A	1022	1035	1059	1070	1125	1146	1174	1213	
	Two-Tone, Polypropylene	L2DNA/CAR	<input type="checkbox"/>		<input type="checkbox"/>	<input type="checkbox"/>	57.00#	936									
	Two-Tone, Upholstered Seat	L2DNB/CAR	<input type="checkbox"/>		<input type="checkbox"/>	<input type="checkbox"/>	57.00#	N/A	1100	1110	1133	1146	1201	1222	1251	1289	

2DNS1
2DNS2
2DNSA
2DNSB

A **B** **C** **D** **E** **F**

HOW TO ORDER

- Indicate the following information on order form:
- Quantity of each item.
 - Model number, including options. See "How To Build a Model Number".
 - Any special service required.

Note:

- The indicates that a choice is required.
- The absence of the indicates that no choice is required.
- Alpha-numeric characters in place of indicate that no other alternatives are available.

HOW TO BUILD A MODEL NUMBER

Refer to ki.com/fabrics

- A** Select basic model.
- B** Select frame color. Refer to the **Product Color Options** page in this price list.
- C** Select solid poly color. Refer to the **Product Color Options** page in this price list.
- D** Select outside/inside poly color. Refer to the **Product Color Options** page in this price list.
- E** Select caster/glide option.
 - C** - Carpet casters
 - S** - Hard floor casters
 - GL** - Glides
 - SCG** - Front hard floor casters, rear glides
 - CCG** - Front carpet casters, rear glides
- F** Select upholstery grade/color.

UPHOLSTERY INFORMATION

C.O.M. Upholstery
C.O.M. requirement for 10 chairs or less with upholstered seat or upholstered seat and back is 3/4 yard per chair of 54" wide nondirectional fabric. For orders of 11 or more with upholstered seat and back and for complete information on ordering C.O.M. see "Ordering C.O.M., C.O.V. and C.O.L." section.

SPECIAL SERVICES

Special Carton Marking
With specially marked information N/C

Shipping
Ships assembled, FOB Green Bay, WI 54302, freight prepaid. Freight class 300.

Specifications and prices are subject to change without prior notice.

Learn2® Classroom Furniture (Delivered)

Doni® Seating without Worksurface



Learn2® Classroom Furniture (Delivered)

Doni® Seating without Worksurface

MODEL	Features	MODEL NUMBER						Approx. Packaged Weight	Delivered Pricing Unupholstered	Delivered Pricing Fabric Grade 1, C.O.M. & COV	Delivered Pricing Fabric Grade 2	Delivered Pricing Fabric Grade 3 & Group 2V Vinyl	Delivered Pricing Pallas Fabric Group P0	Delivered Pricing Pallas Fabric Group P1	Delivered Pricing Pallas Fabric Group P2	Delivered Pricing Pallas Fabric Group P3	Delivered Pricing Pallas Fabric Group P4
		Basic Model	Frame Color	Poly Solid Color	Poly Outside/Inside Color	Glide Option	Uph. Color										
 <p>No Worksurface - Poly Bookbag Rack</p> <ul style="list-style-type: none"> • Poly bookbag rack included • Poly bookbag rack includes two accessory slots and a cupholder • Poly Bookbag rack is only available in black • Solid or two-tone colored shell • Unlimited color match's • 17 degrees of hip articulation 	Solid Color, Polypropylene	L2DN1/PBR	<input type="checkbox"/>	<input type="checkbox"/>		<input type="checkbox"/>	57.00#	\$ 840									
	Solid Color, Upholstered Seat	L2DN2/PBR	<input type="checkbox"/>	<input type="checkbox"/>		<input type="checkbox"/>	57.00#	N/A	1001	1015	1035	1047	1103	1124	1152	1191	
	Two-Tone, Polypropylene	L2DNA/PBR	<input type="checkbox"/>		<input type="checkbox"/>	<input type="checkbox"/>	57.00#	915									
	Two-Tone, Upholstered Seat	L2DNB/PBR	<input type="checkbox"/>		<input type="checkbox"/>	<input type="checkbox"/>	57.00#	N/A	1076	1089	1113	1124	1178	1200	1230	1267	

- 2DNS1
- 2DNS2
- 2DNSA
- 2DNSB

A B C D E F

HOW TO ORDER

- Indicate the following information on order form:
1. Quantity of each item.
 2. Model number, including options. See "How To Build a Model Number".
 3. Any special service required.

Note:

- The indicates that a choice is required.
- The absence of the indicates that no choice is required.
- Alpha-numeric characters in place of indicate that no other alternatives are available.

HOW TO BUILD A MODEL NUMBER

Refer to ki.com/fabrics

- A** Select basic model.
- B** Select frame color. Refer to the **Product Color Options** page in this price list.
- C** Select solid poly color. Refer to the **Product Color Options** page in this price list.
- D** Select outside/inside poly color. Refer to the **Product Color Options** page in this price list.
- E** Select caster/glide option.
 - C** - Carpet casters
 - S** - Hard floor casters
 - GL** - Glides
 - SCG** - Front hard floor casters, rear glides
 - CCG** - Front carpet casters, rear glides
- F** Select upholstery grade/color.

UPHOLSTERY INFORMATION

C.O.M. Upholstery

C.O.M. requirement for 10 chairs or less with upholstered seat or upholstered seat and back is 3/4 yard per chair of 54" wide nondirectional fabric. For orders of 11 or more with upholstered seat and back and for complete information on ordering C.O.M. see "Ordering C.O.M., C.O.V. and C.O.L." section.

FINISH INFORMATION

Poly Bookbag Rack comes standard in Black. Other KI standard poly colors are available through a Product Modification Request. No upcharge or fees apply for orders of 20 or more. A net setup fee applies for orders of 19 or less. Please allow up 1 week additional leadtime.

SPECIAL SERVICES

Special Carton Marking

With specially marked information N/C

Shipping

Ships **assembled, FOB Green Bay, WI 54302, freight prepaid.** Freight class 300.

Specifications and prices are subject to change without prior notice.



MODEL	Features	MODEL NUMBER						Approx. Packaged Weight	Delivered Pricing Unupholstered	Delivered Pricing Fabric Grade 1, C.O.M. & COV	Delivered Pricing Fabric Grade 2	Delivered Pricing Fabric Grade 3 & Group 2V Vinyl	Delivered Pricing Pallas Fabric Group P0	Delivered Pricing Pallas Fabric Group P1	Delivered Pricing Pallas Fabric Group P2	Delivered Pricing Pallas Fabric Group P3	Delivered Pricing Pallas Fabric Group P4
		Basic Model	Frame Color	Poly Solid Color	Poly Outside/Inside Color	Glide Option	Uph. Color										
 <p>No Worksurface - Flat Accessory Rack</p> <ul style="list-style-type: none"> Flat accessory rack included Solid or two-tone colored shell Unlimited color match's 17 degrees of hip articulation 	Solid Color, Polypropylene	L2DN1/FBR	<input type="checkbox"/>	<input type="checkbox"/>		<input type="checkbox"/>	57.00#	\$ 860									
	Solid Color, Upholstered Seat	L2DN2/FBR	<input type="checkbox"/>	<input type="checkbox"/>		<input type="checkbox"/>	57.00#	N/A	1022	1035	1059	1070	1125	1146	1174	1213	
	Two-Tone, Polypropylene	L2DNA/FBR	<input type="checkbox"/>		<input type="checkbox"/>	<input type="checkbox"/>	57.00#	936									
	Two-Tone, Upholstered Seat	L2DNB/FBR	<input type="checkbox"/>		<input type="checkbox"/>	<input type="checkbox"/>	57.00#	N/A	1100	1110	1133	1146	1201	1222	1251	1289	

2DNS1
2DNS2
2DNSA
2DNSB

A **B** **C** **D** **E** **F**

HOW TO ORDER

Indicate the following information on order form:

- Quantity of each item.
- Model number, including options. See "How To Build a Model Number".
- Any special service required.

Note:

- The indicates that a choice is required.
- The absence of the indicates that no choice is required.
- Alpha-numeric characters in place of indicate that no other alternatives are available.

HOW TO BUILD A MODEL NUMBER

Refer to ki.com/fabrics

- A** Select basic model.
- B** Select frame color. Refer to the **Product Color Options** page in this price list.
- C** Select solid poly color. Refer to the **Product Color Options** page in this price list.
- D** Select outside/inside poly color. Refer to the **Product Color Options** page in this price list.
- E** Select caster/glide option.
 - C** - Carpet casters
 - S** - Hard floor casters
 - GL** - Glides
 - SCG** - Front hard floor casters, rear glides
 - CCG** - Front carpet casters, rear glides
- F** Select upholstery grade/color.

UPHOLSTERY INFORMATION

C.O.M. Upholstery
C.O.M. requirement for 10 chairs or less with upholstered seat or upholstered seat and back is 3/4 yard per chair of 54" wide nondirectional fabric. For orders of 11 or more with upholstered seat and back and for complete information on ordering C.O.M. see "Ordering C.O.M., C.O.V. and C.O.L." section.

SPECIAL SERVICES

Special Carton Marking

With specially marked information N/C

Shipping
Ships **assembled, FOB Green Bay, WI 54302, freight prepaid.** Freight class 300.

Specifications and prices are subject to change without prior notice.



Learn2® Classroom Furniture (Delivered)

Intellect Wave® Seating without Worksurface



Learn2® Classroom Furniture (Delivered)

Intellect Wave® Seating without Worksurface

MODEL	Features	MODEL NUMBER					Approx. Packaged Weight	Delivered Pricing	Delivered Pricing Fabric Grade 1, C.O.M. & COV	Delivered Pricing Fabric Grade 2	Delivered Pricing Fabric Grade 3 & Group 2V Vinyl	Delivered Pricing Pallas Fabric Group P0	Delivered Pricing Pallas Fabric Group P1	Delivered Pricing Pallas Fabric Group P2	Delivered Pricing Pallas Fabric Group P3	Delivered Pricing Pallas Fabric Group P4
		Basic Model	Frame Color	Shell Color	Glide Option	Upholstery Color										
 2WNSP 2WNSU	No Worksurface - Without Accessory Rack Polypropylene Upholstered Seat	L2WNP/NAR	<input type="checkbox"/>	<input type="checkbox"/>	<input type="checkbox"/>		33.00#	\$ 558								
		L2WNUS/NAR	<input type="checkbox"/>	<input type="checkbox"/>	<input type="checkbox"/>	<input type="checkbox"/>		36.00#	N/A	631	637	648	637	688	706	729
 2WNSP 2WNSU	No Worksurface - Accessory Rack • Accessory rack included on both sides of frame Polypropylene Upholstered Seat	L2WNP/SAR	<input type="checkbox"/>	<input type="checkbox"/>	<input type="checkbox"/>		42.00#	\$ 587								
		L2WNUS/SAR	<input type="checkbox"/>	<input type="checkbox"/>	<input type="checkbox"/>	<input type="checkbox"/>		45.00#	N/A	661	669	678	669	719	735	756
 2WNSP 2WNSU	No Worksurface - Cup Holder/Accessory Rack • Cup holder/accessory rack included on both sides of frame Polypropylene Upholstered Seat	L2WNP/CAR	<input type="checkbox"/>	<input type="checkbox"/>	<input type="checkbox"/>		42.00#	\$ 636								
		L2WNUS/CAR	<input type="checkbox"/>	<input type="checkbox"/>	<input type="checkbox"/>	<input type="checkbox"/>		45.00#	N/A	709	714	728	714	769	784	806

A **B** **C** **D** **E**

HOW TO ORDER

- Indicate the following information on order form:
- Quantity of each item.
 - Model number, including options. See "How To Build a Model Number".
 - Any special service required.

Note: • The indicates that a choice is required.
 • The absence of the indicates that no choice is required.
 • Alpha-numeric characters in place of indicate that no other alternatives are available.

HOW TO BUILD A MODEL NUMBER

- A** Select basic model.
- B** Select frame color.
Refer to the **Product Color Options** page in this price list.
- C** Select shell color.
Refer to the **Product Color Options** page in this price list.
- D** Select caster/glide option.

C	- Carpet casters
S	- Hard floor casters
GL	- Glides
SCG	- Front hard floor casters, rear glides
CCG	- Front carpet casters, rear glides
- E** Select upholstery grade/color.
Refer to ki.com/fabrics

UPHOLSTERY INFORMATION

C.O.M. Upholstery
 C.O.M. requirement is 5/8 yard per chair for seat of 54" wide nondirectional fabric. For complete information on ordering C.O.M. see "Ordering C.O.M., C.O.V. and C.O.L." section.

SPECIAL SERVICES

Special Carton Marking

With specially marked information N/C

Shipping
 Ships **assembled, FOB Green Bay, WI 54302, freight prepaid.** Freight class 300.

Specifications and prices are subject to change without prior notice.



Learn2® Classroom Furniture (Delivered)

Intellect Wave® Seating without Worksurface



Learn2® Classroom Furniture (Delivered)

Intellect Wave® Seating without Worksurface

MODEL	Features	MODEL NUMBER					Approx. Packaged Weight	Delivered Pricing	Delivered Pricing Fabric Grade 1, C.O.M. & COV	Delivered Pricing Fabric Grade 2	Delivered Pricing Fabric Grade 3 & Group 2V Vinyl	Delivered Pricing Pallas Fabric Group P0	Delivered Pricing Pallas Fabric Group P1	Delivered Pricing Pallas Fabric Group P2	Delivered Pricing Pallas Fabric Group P3	Delivered Pricing Pallas Fabric Group P4
		Basic Model	Frame Color	Shell Color	Glide Option	Upholstery Color										
 2WNSP 2WNSU	No Worksurface - Poly Bookbag Rack • Poly bookbag rack included • Poly bookbag rack includes two accessory slots and a cupholder • Poly Bookbag rack is only available in black	Polypropylene	L2WNP/PBR	<input type="checkbox"/>	<input type="checkbox"/>	<input type="checkbox"/>	42.00#	\$ 617								
		Upholstered Seat	L2WNUS/PBR	<input type="checkbox"/>	<input type="checkbox"/>	<input type="checkbox"/>	<input type="checkbox"/>	45.00#	N/A	690	696	706	696	745	765	786
 2WNSP 2WNSU	No Worksurface - Flat Accessory Rack • Flat accessory rack included	Polypropylene	L2WNP/FBR	<input type="checkbox"/>	<input type="checkbox"/>	<input type="checkbox"/>	42.00#	\$ 636								
		Upholstered Seat	L2WNUS/FBR	<input type="checkbox"/>	<input type="checkbox"/>	<input type="checkbox"/>	<input type="checkbox"/>	45.00#	N/A	709	714	728	714	769	784	806

A **B** **C** **D** **E**

HOW TO ORDER

- Indicate the following information on order form:
- Quantity of each item.
 - Model number, including options. See "How To Build a Model Number".
 - Any special service required.

Note: • The indicates that a choice is required.
 • The absence of the indicates that no choice is required.
 • Alpha-numeric characters in place of indicate that no other alternatives are available.

HOW TO BUILD A MODEL NUMBER

- A** Select basic model.
- B** Select frame color. Refer to the **Product Color Options** page in this price list.
- C** Select shell color. Refer to the **Product Color Options** page in this price list.
- D** Select caster/glide option.

C	- Carpet casters
S	- Hard floor casters
GL	- Glides
SCG	- Front hard floor casters, rear glides
CCG	- Front carpet casters, rear glides
- E** Select upholstery grade/color. Refer to ki.com/fabrics

UPHOLSTERY INFORMATION

C.O.M. Upholstery
 C.O.M. requirement is 5/8 yard per chair for seat of 54" wide nondirectional fabric. For complete information on ordering C.O.M. see "Ordering C.O.M., C.O.V. and C.O.L." section.

FINISH INFORMATION

Poly Bookbag Rack comes standard in Black. Other KI standard poly colors are available through a Product Modification Request. No upcharge or fees apply for orders of 20 or more. A net setup fee applies for orders of 19 or less. Please allow up 1 week additional leadtime.

SPECIAL SERVICES



Special Carton Marking

With specially marked information N/C

Shipping
 Ships assembled, FOB Green Bay, WI 54302, freight prepaid. Freight class 300.

Specifications and prices are subject to change without prior notice.



MODEL	Features	MODEL NUMBER					Approx. Packaged Weight	Delivered Pricing	Delivered Pricing Fabric Grade 1, C.O.M. & COV	Delivered Pricing Fabric Grade 2	Delivered Pricing Fabric Grade 3 & Group 2V Vinyl	Delivered Pricing Vinyl Group 2V	Delivered Pricing Pallas Fabric Group P0	Delivered Pricing Pallas Fabric Group P1	Delivered Pricing Pallas Fabric Group P2	Delivered Pricing Pallas Fabric Group P3	Delivered Pricing Pallas Fabric Group P4
		Basic Model	Frame Color	Shell Color	Glide Option	Uph. Color											
 2LNS1 2LNS2	No Worksurface - Without Accessory Rack Polypropylene Upholstered Seat • One-piece shell • Passive back flex	L2LN1/NA/NAR	<input type="checkbox"/>	<input type="checkbox"/>	<input type="checkbox"/>	45.00#	\$ 726										
		L2LN2/NA/NAR	<input type="checkbox"/>	<input type="checkbox"/>	<input type="checkbox"/>	<input type="checkbox"/>	47.00#	N/A	804	804	839	839	847	901	925	953	976
 2LNS1 2LNS2	No Worksurface - Accessory Rack Polypropylene Upholstered Seat • One-piece shell • Passive black flex • Accessory rack included on both sides of frame	L2LN1/NA/SAR	<input type="checkbox"/>	<input type="checkbox"/>	<input type="checkbox"/>	53.00#	\$ 756										
		L2LN2/NA/SAR	<input type="checkbox"/>	<input type="checkbox"/>	<input type="checkbox"/>	<input type="checkbox"/>	55.00#	N/A	834	868	886	886	876	930	954	982	1005
 2LNS1 2LNS2	No Worksurface - Cup Holder/Accessory Rack Polypropylene Upholstered Seat • One-piece shell • Passive back flex • Cup holder/accessory rack included on both sides of frame	L2LN1/NA/CAR	<input type="checkbox"/>	<input type="checkbox"/>	<input type="checkbox"/>	53.00#	\$ 805										
		L2LN2/NA/CAR	<input type="checkbox"/>	<input type="checkbox"/>	<input type="checkbox"/>	<input type="checkbox"/>	55.00#	N/A	886	920	938	938	928	982	1006	1034	1057

A **B** **C** **D** **E**

HOW TO ORDER

- Indicate the following information on order form:
- Quantity of each item.
 - Model number, including options. See "How To Build a Model Number".
 - Any special service required.

Note: • The indicates that a choice is required.
 • The absence of the indicates that no choice is required.
 • Alpha-numeric characters in place of indicate that no other alternatives are available.

HOW TO BUILD A MODEL NUMBER

- A** Select basic model.
- B** Select frame color.
Refer to the **Product Color Options** page in this price list.
- C** Select poly seat and back color.
Refer to the **Product Color Options** page in this price list.
- D** Select caster/glide option.

C	- Carpet casters
S	- Hard floor casters
GL	- Glides
SCG	- Front hard floor casters, rear glides
CCG	- Front carpet casters, rear glides
- E** Select upholstery grade/color.
Refer to ki.com/fabrics

UPHOLSTERY INFORMATION

C.O.M. Upholstery
 C.O.M. requirement for 10 chairs or less with upholstered seat or upholstered seat and back is 3/4 yard per chair of 54" wide nondirectional fabric. For orders of 11 or more with upholstered seat and back and for complete information on ordering C.O.M. see "Ordering C.O.M., C.O.V. and C.O.L." section.

SPECIAL SERVICES

Special Carton Marking



With specially marked information N/C

Shipping

Ships **assembled, FOB Green Bay, WI 54302, freight prepaid.** Freight class 300.

Specifications and prices are subject to change without prior notice.



MODEL	Features	MODEL NUMBER					Approx. Packaged Weight	Delivered Pricing	Delivered Pricing Fabric Grade 1, C.O.M. & COV	Delivered Pricing Fabric Grade 2	Delivered Pricing Fabric Grade 3 & Group 2V Vinyl	Delivered Pricing Vinyl Group 2V	Delivered Pricing Pallas Fabric Group P0	Delivered Pricing Pallas Fabric Group P1	Delivered Pricing Pallas Fabric Group P2	Delivered Pricing Pallas Fabric Group P3	Delivered Pricing Pallas Fabric Group P4
		Basic Model	Frame Color	Shell Color	Glide Option	Uph. Color											
 2LNS1 2LNS2	No Worksurface - Poly Bookbag Rack • One-piece shell • Passive back flex • Poly bookbag rack included • Poly bookbag rack includes two accessory slots and a cupholder • Poly Bookbag rack is only available in black	Polypropylene	<input type="checkbox"/>	<input type="checkbox"/>	<input type="checkbox"/>	49.00#	\$ 787										
		Upholstered Seat	<input type="checkbox"/>	<input type="checkbox"/>	<input type="checkbox"/>	<input type="checkbox"/>	51.00#	N/A	864	898	916	916	906	960	984	1012	1035
 2LNS1 2LNS2	No Worksurface - Flat Accessory Rack • One-piece shell • Passive back flex • Flat accessory rack included	Polypropylene	<input type="checkbox"/>	<input type="checkbox"/>	<input type="checkbox"/>	55.00#	\$ 805										
		Upholstered Seat	<input type="checkbox"/>	<input type="checkbox"/>	<input type="checkbox"/>	<input type="checkbox"/>	57.00#	N/A	886	920	938	938	928	982	1006	1034	1057

A **B** **C** **D** **E**

HOW TO ORDER

- Indicate the following information on order form:
- Quantity of each item.
 - Model number, including options. See "How To Build a Model Number".
 - Any special service required.

Note: • The indicates that a choice is required.
 • The absence of the indicates that no choice is required.
 • Alpha-numeric characters in place of indicate that no other alternatives are available.

HOW TO BUILD A MODEL NUMBER

- A** Select basic model.
- B** Select frame color. Refer to the **Product Color Options** page in this price list.
- C** Select poly seat and back color. Refer to the **Product Color Options** page in this price list.
- D** Select caster/glide option.

C	- Carpet casters
S	- Hard floor casters
GL	- Glides
SCG	- Front hard floor casters, rear glides
CCG	- Front carpet casters, rear glides
- E** Select upholstery grade/color. Refer to ki.com/fabrics

UPHOLSTERY INFORMATION

C.O.M. Upholstery
 C.O.M. requirement for 10 chairs or less with upholstered seat or upholstered seat and back is 3/4 yard per chair of 54" wide nondirectional fabric. For orders of 11 or more with upholstered seat and back and for complete information on ordering C.O.M. see "Ordering C.O.M., C.O.V. and C.O.L." section.

FINISH INFORMATION

Poly Bookbag Rack comes standard in Black. Other KI standard poly colors are available through a Product Modification Request. No upcharge or fees apply for orders of 20 or more. A net setup fee applies for orders of 19 or less. Please allow up 1 week additional leadtime.

SPECIAL SERVICES

Special Carton Marking



With specially marked information N/C

Shipping

Ships **assembled, FOB Green Bay, WI 54302, freight prepaid.** Freight class 300.

Specifications and prices are subject to change without prior notice.



MODEL	Features	MODEL NUMBER					Approx. Packaged Weight	Delivered Pricing	Delivered Pricing Fabric Grade 1, C.O.M. & COV	Delivered Pricing Fabric Grade 2	Delivered Pricing Fabric Grade 3 & Group 2V Vinyl	Delivered Pricing Pallas Fabric Group P0	Delivered Pricing Pallas Fabric Group P1	Delivered Pricing Pallas Fabric Group P2	Delivered Pricing Pallas Fabric Group P3	Delivered Pricing Pallas Fabric Group P4
		Basic Model	Frame Color	Shell Color	Glide Option	Upholstery Color										
 2SNSP 2SNSU	No Worksurface - Without Accessory Rack	Polypropylene	L2SNP/NA/NAR	<input type="checkbox"/>	<input type="checkbox"/>	<input type="checkbox"/>	44.00#	\$ 720								
		Upholstered Seat	L2SNUS/NA/NAR	<input type="checkbox"/>	<input type="checkbox"/>	<input type="checkbox"/>	47.00#	N/A	798	837	851	844	896	923	949	972
 2SNSP 2SNSU	No Worksurface - Accessory Rack • Accessory rack included on both sides of frame	Polypropylene	L2SNP/NA/SAR	<input type="checkbox"/>	<input type="checkbox"/>	<input type="checkbox"/>	53.00#	\$ 749								
		Upholstered Seat	L2SNUS/NA/SAR	<input type="checkbox"/>	<input type="checkbox"/>	<input type="checkbox"/>	56.00#	N/A	827	865	882	872	926	953	978	1004
 2SNSP 2SNSU	No Worksurface - Cup Holder/Accessory Rack • Cup holder/accessory rack included on both sides of frame	Polypropylene	L2SNP/NA/CAR	<input type="checkbox"/>	<input type="checkbox"/>	<input type="checkbox"/>	53.00#	\$ 799								
		Upholstered Seat	L2SNUS/NA/CAR	<input type="checkbox"/>	<input type="checkbox"/>	<input type="checkbox"/>	56.00#	N/A	879	917	932	924	976	1004	1029	1053

A **B** **C** **D** **E**

HOW TO ORDER

- Indicate the following information on order form:
- Quantity of each item.
 - Model number, including options. See "How To Build a Model Number".
 - Any special service required.

Note: • The indicates that a choice is required.
 • The absence of the indicates that no choice is required.
 • Alpha-numeric characters in place of indicate that no other alternatives are available.

HOW TO BUILD A MODEL NUMBER

- A** Select basic model.
- B** Select frame color. Refer to the **Product Color Options** page in this price list.
- C** Select poly seat and back color. Refer to the **Product Color Options** page in this price list.
- D** Select caster/glide option.

C	- Carpet casters
S	- Hard floor casters
GL	- Glides
SCG	- Front hard floor casters, rear glides
CCG	- Front carpet casters, rear glides
- E** Select upholstery grade/color. Refer to ki.com/fabrics

UPHOLSTERY INFORMATION

C.O.M. Upholstery
 C.O.M. requirement for 10 chairs or less with upholstered seat or upholstered seat and back is 3/4 yard per chair of 54" wide nondirectional fabric. For orders of 11 or more with upholstered seat and back and for complete information on ordering C.O.M. see "Ordering C.O.M., C.O.V. and C.O.L." section.



SPECIAL SERVICES

Special Carton Marking
 With specially marked information N/C

Shipping
 Ships **assembled, FOB Green Bay, WI 54302, freight prepaid.** Freight class 300.

Specifications and prices are subject to change without prior notice.



MODEL	Features	MODEL NUMBER					Approx. Packaged Weight	Delivered Pricing	Delivered Pricing Fabric Grade 1, C.O.M. & COV	Delivered Pricing Fabric Grade 2	Delivered Pricing Fabric Grade 3 & Group 2V Vinyl	Delivered Pricing Pallas Fabric Group P0	Delivered Pricing Pallas Fabric Group P1	Delivered Pricing Pallas Fabric Group P2	Delivered Pricing Pallas Fabric Group P3	Delivered Pricing Pallas Fabric Group P4
		Basic Model	Frame Color	Shell Color	Glide Option	Upholstery Color										
 2SNSP 2SNSU	No Worksurface - Poly Bookbag Rack • Poly bookbag rack included • Poly bookbag rack includes two accessory slots and a cupholder • Poly Bookbag rack is only available in black	Polypropylene	L2SNP/NA/PBR	<input type="checkbox"/>	<input type="checkbox"/>	<input type="checkbox"/>	53.00#	\$ 780								
		Upholstered Seat	L2SNUS/NA/PBR	<input type="checkbox"/>	<input type="checkbox"/>	<input type="checkbox"/>	56.00#	N/A	857	895	910	904	955	982	1008	1031
 2SNSP 2SNSU	No Worksurface - Flat Accessory Rack • Flat accessory rack included	Polypropylene	L2SNP/NA/FBR	<input type="checkbox"/>	<input type="checkbox"/>	<input type="checkbox"/>	53.00#	\$ 784								
		Upholstered Seat	L2SNUS/NA/FBR	<input type="checkbox"/>	<input type="checkbox"/>	<input type="checkbox"/>	56.00#	N/A	862	899	914	924	957	985	1009	1033
				A	B	C	D	E								

HOW TO ORDER

- Indicate the following information on order form:
- Quantity of each item.
 - Model number, including options. See "How To Build a Model Number".
 - Any special service required.

Note:

- The indicates that a choice is required.
- The absence of the indicates that no choice is required.
- Alpha-numeric characters in place of indicate that no other alternatives are available.

HOW TO BUILD A MODEL NUMBER

- A** Select basic model.
- B** Select frame color. Refer to the **Product Color Options** page in this price list.
- C** Select poly seat and back color. Refer to the **Product Color Options** page in this price list.
- D** Select caster/glide option.

C	- Carpet casters
S	- Hard floor casters
GL	- Glides
SCG	- Front hard floor casters, rear glides
CCG	- Front carpet casters, rear glides
- E** Select upholstery grade/color. Refer to ki.com/fabrics

UPHOLSTERY INFORMATION

C.O.M. Upholstery
 C.O.M. requirement for 10 chairs or less with upholstered seat or upholstered seat and back is 3/4 yard per chair of 54" wide nondirectional fabric. For orders of 11 or more with upholstered seat and back and for complete information on ordering C.O.M. see "Ordering C.O.M., C.O.V. and C.O.L." section.

FINISH INFORMATION

Poly Bookbag Rack comes standard in Black. Other KI standard poly colors are available through a Product Modification Request. No upcharge or fees apply for orders of 20 or more. A net setup fee applies for orders of 19 or less. Please allow up 1 week additional leadtime.

SPECIAL SERVICES



Special Carton Marking

With specially marked information N/C

Shipping
 Ships **assembled, FOB Green Bay, WI 54302, freight prepaid.** Freight class 300.

Specifications and prices are subject to change without prior notice.



MODEL	Features	MODEL NUMBER					Approx. Packaged Weight	Delivered Pricing	Delivered Pricing Fabric Grade 1, C.O.M. & COV	Delivered Pricing Fabric Grade 2	Delivered Pricing Fabric Grade 3 & Group 2V Vinyl	Delivered Pricing Pallas Fabric Group P0	Delivered Pricing Pallas Fabric Group P1	Delivered Pricing Pallas Fabric Group P2	Delivered Pricing Pallas Fabric Group P3	Delivered Pricing Pallas Fabric Group P4
		Basic Model	Frame Color	Shell Color	Glide Option	Upholstery Color										
 No Worksurface - Armchair without Accessory Rack	Polypropylene	L2SNP/CA/NAR	<input type="checkbox"/>	<input type="checkbox"/>	<input type="checkbox"/>	47.00#	\$ 796									
	Upholstered Seat	L2SNUS/CA/NAR	<input type="checkbox"/>	<input type="checkbox"/>	<input type="checkbox"/>	50.00#	N/A	872	909	926	934	987	998	1025	1048	
2SNSP 2SNSU																
 No Worksurface - Armchair with Accessory Rack • Accessory rack included on both sides of frame	Polypropylene	L2SNP/CA/SAR	<input type="checkbox"/>	<input type="checkbox"/>	<input type="checkbox"/>	56.00#	\$ 825									
	Upholstered Seat	L2SNUS/CA/SAR	<input type="checkbox"/>	<input type="checkbox"/>	<input type="checkbox"/>	59.00#	N/A	904	941	957	949	1004	1027	1057	1077	
2SNSP 2SNSU																
 No Worksurface - Armchair with Cup Holder/Accessory Rack • Cup holder/accessory rack included on both sides of frame	Polypropylene	L2SNP/CA/CAR	<input type="checkbox"/>	<input type="checkbox"/>	<input type="checkbox"/>	56.00#	\$ 875									
	Upholstered Seat	L2SNUS/CA/CAR	<input type="checkbox"/>	<input type="checkbox"/>	<input type="checkbox"/>	59.00#	N/A	954	990	1007	999	1053	1077	1105	1128	
2SNSP 2SNSU																

A **B** **C** **D** **E**

HOW TO ORDER

- Indicate the following information on order form:
- Quantity of each item.
 - Model number, including options. See "How To Build a Model Number".
 - Any special service required.

Note: • The indicates that a choice is required.
 • The absence of the indicates that no choice is required.
 • Alpha-numeric characters in place of indicate that no other alternatives are available.

HOW TO BUILD A MODEL NUMBER

- A** Select basic model.
- B** Select frame color. Refer to the **Product Color Options** page in this price list.
- C** Select poly seat and back color. Refer to the **Product Color Options** page in this price list.
- D** Select caster/glide option.

C	- Carpet casters
S	- Hard floor casters
GL	- Glides
SCG	- Front hard floor casters, rear glides
CCG	- Front carpet casters, rear glides
- E** Select upholstery grade/color. Refer to ki.com/fabrics

UPHOLSTERY INFORMATION

C.O.M. Upholstery
 C.O.M. requirement for 10 chairs or less with upholstered seat or upholstered seat and back is 3/4 yard per chair of 54" wide nondirectional fabric. For orders of 11 or more with upholstered seat and back and for complete information on ordering C.O.M. see "Ordering C.O.M., C.O.V. and C.O.L." section.

SPECIAL SERVICES



Special Carton Marking

With specially marked information N/C

Shipping
 Ships **assembled, FOB Green Bay, WI 54302, freight prepaid.** Freight class 300.

Specifications and prices are subject to change without prior notice.



MODEL	Features	MODEL NUMBER					Approx. Packaged Weight	Delivered Pricing	Delivered Pricing Fabric Grade 1, C.O.M. & COV	Delivered Pricing Fabric Grade 2	Delivered Pricing Fabric Grade 3 & Group 2V Vinyl	Delivered Pricing Pallas Fabric Group P0	Delivered Pricing Pallas Fabric Group P1	Delivered Pricing Pallas Fabric Group P2	Delivered Pricing Pallas Fabric Group P3	Delivered Pricing Pallas Fabric Group P4
		Basic Model	Frame Color	Shell Color	Glide Option	Upholstery Color										
 <p>No Worksurface - Armchair with Poly Bookbag Rack</p> <ul style="list-style-type: none"> • Poly bookbag rack included • Poly bookbag rack includes two accessory slots and a cupholder • Poly Bookbag rack is only available in black 	Polypropylene	L2SNP/CA/PBR	<input type="checkbox"/>	<input type="checkbox"/>	<input type="checkbox"/>	56.00#	\$ 854									
	Upholstered Seat	L2SNUS/CA/PBR	<input type="checkbox"/>	<input type="checkbox"/>	<input type="checkbox"/>	59.00#	N/A	932	969	985	995	1048	1058	1083	1106	
2SNSP 2SNSU																
 <p>No Worksurface - Armchair with Flat Accessory Rack</p> <ul style="list-style-type: none"> • Flat accessory rack included 	Polypropylene	L2SNP/CA/FBR	<input type="checkbox"/>	<input type="checkbox"/>	<input type="checkbox"/>	56.00#	\$ 858									
	Upholstered Seat	L2SNUS/CA/FBR	<input type="checkbox"/>	<input type="checkbox"/>	<input type="checkbox"/>	59.00#	N/A	936	971	988	999	1033	1056	1084	1106	
2SNSP 2SNSU																

A **B** **C** **D** **E**

HOW TO ORDER

- Indicate the following information on order form:
1. Quantity of each item.
 2. Model number, including options. See "How To Build a Model Number".
 3. Any special service required.

Note:

- The indicates that a choice is required.
- The absence of the indicates that no choice is required.
- Alpha-numeric characters in place of indicate that no other alternatives are available.

HOW TO BUILD A MODEL NUMBER

- A** Select basic model.
- B** Select frame color. Refer to the **Product Color Options** page in this price list.
- C** Select poly seat and back color. Refer to the **Product Color Options** page in this price list.
- D** Select caster/glide option.

C	- Carpet casters
S	- Hard floor casters
GL	- Glides
SCG	- Front hard floor casters, rear glides
CCG	- Front carpet casters, rear glides
- E** Select upholstery grade/color. Refer to ki.com/fabrics

UPHOLSTERY INFORMATION

C.O.M. Upholstery
 C.O.M. requirement for 10 chairs or less with upholstered seat or upholstered seat and back is 3/4 yard per chair of 54" wide nondirectional fabric. For orders of 11 or more with upholstered seat and back and for complete information on ordering C.O.M. see "Ordering C.O.M., C.O.V. and C.O.L." section.

FINISH INFORMATION

Poly Bookbag Rack comes standard in Black. Other KI standard poly colors are available through a Product Modification Request. No upcharge or fees apply for orders of 20 or more. A net setup fee applies for orders of 19 or less. Please allow up 1 week additional leadtime.

SPECIAL SERVICES

Special Carton Marking

With specially marked information N/C

Shipping
 Ships **assembled, FOB Green Bay, WI 54302, freight prepaid.** Freight class 300.

Specifications and prices are subject to change without prior notice.



1330 BELLEVUE STREET
GREEN BAY, WI 54302
800.424.2432 / KI.COM

KI is a trusted expert for furniture and wall systems around the globe.
USA | CANADA | MEXICO | UK | EUROPE | ASIA | MIDDLE EAST
© 2026 Krueger International, Inc. All Rights Reserved.