



MYPLACETM LOUNGE FURNITURE

PRICE LIST

EFFECTIVE MARCH 31, 2026
800.424.2432

Fabric Yardage Pricing	3
Ordering Customer's Own Material (C.O.M.) Upholstery	
Information	4
MyPlace™ Lounge Seating	
General Information - Ottoman, Backless and 32" Low-Back	5
Technical Specifications - Ottoman, Backless and 32" Low-Back	7
Product Color Options	11
Ottomans	12
Junior Ottomans	19
Backless Lounge Seating	33
32" Low-Back Lounge Seating	38
General Information, 48" High-Back	51
General Information, 60" High-Back	52
Technical Specifications - High-Back	53
48" High-Back Lounge Seating	56
60" High-Back Lounge Seating	82
MyPlace™ Tables	
Technical Specifications - Tables	?
Tables	109
MyPlace™ Curved Shelving	
General Information, Curved Shelving	111
Curved Shelving - 30°	113
Curved Shelving - 45°	115
MyPlace™ Accessories	
Gangers	117
Active Base, Byrne Interlink® IQ Infeed and Jumper	117
C-Table™	
General Information and Technical Specifications, C-Table™	119
General Information, C-Table™ Max	120
Technical Specifications, C-Table Max™	121
Product Color Options	123
27" Fixed Height	124
C-Table™ Max	
26" Fixed Height	125
29" Fixed Height	128
25" - 30" Adjustable Height	131
Athens® Booth Tables	
General Information	134
Product Color Options	136
Square--Flat Disc Base, 4" Column, Fixed Height	137
Rectangular--Flat Disc Base, 4" Column, Fixed Height	138
MyPlace™ Pillar™ Tables	
General Information	139
Product Color Options	142
Inside Curve - 29" High, 18" and 24" Deep	143
Inside Curve - 36" High, 18" and 24" Deep	144
Inside Curve - 42" High, 18" and 24" Deep	145
Outside Curve - 18" High and 24" Deep	146
Rectangular - 29" High, 18" and 24" Deep	147
Rectangular - 36" High, 18" and 24" Deep	148
Rectangular - 42" High, 18" and 24" Deep	149
Inside Curve - 29" High w/Single Circuit	150
Inside Curve - 36" High w/Single Circuit	151
Inside Curve - 42" High w/Single Circuit	152
Rectangular - 29" High w/Single Circuit, 18" and 24" Deep	153
Rectangular - 36" High w/Single Circuit, 18" and 24" Deep	154
Rectangular - 42" High w/Single Circuit, 18" and 24" Deep	155



Yardage	Grade	List Price Per Yard
1	C	\$ 49
1	D	\$ 64
1	E	\$ 78
1	F	\$ 100
1	G	\$ 122
1	H	\$ 144
1	I	\$ 178
1	J	\$ 222
1	K	\$ 289
1	L	\$ 333
1	M	\$ 422

To calculate the fabric option price, multiply the model's total yardage by the fabric grade's list price per yard. Add this fabric option price to the base model price to determine the total price. Fabric yardage can be found on the model pricing page.



Specifications Form January 2023

How to Specify

As a standard procedure, KI applies seating upholstery as swatched by the textile distributor. Reference distributor's website. Upholstery that is required to be applied differently than is swatched, will need a Product Modification Request written specifying the direction the upholstery is to be applied. RAILOADED FABRIC REQUIRES A PRODUCT MODIFICATION REQUEST DUE TO ADDITIONAL YARDAGE REQUIREMENTS

Seating upholstery requiring specific positioning of intricate patterns or patterns repeats on seats and backrests, will need a Product Modification Request written including a sketch noting the specific requirements, as in Diagram A.

C.O.M. must be supplied in continuous yardage.

Yardage requirements listed in price list are based on plain goods 54" wide. Fabrics less than 54" wide, or those requiring matching (stripes, plaids, prints, large patterns) will require additional yardage based on the fabric used and the item ordered. Consult matrix below for additional yardage needed.

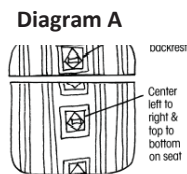

C.O.M. INCREASE MATRIX (yardage matrix is also applicable to any reservations of KI Ingrade, Pallas, or K.O.M. upholsteries).

This table is a general guide.

FABRIC WIDTH	PLAIN FABRIC	UNDER 7"	8"-13"	14"-21"	22"-27"	28"-33"	34"-40"	41"-48"
		REPEAT	REPEAT	REPEAT	REPEAT	REPEAT	REPEAT	REPEAT
54"	0	20%	25%	30%	45%	55%	70%	80%
51"-53"	15%	25%	30%	35%	50%	60%	80%	90%
48"-50"	20%	30%	35%	40%	55%	65%	85%	95%
45"-47"	30%	45%	50%	55%	60%	80%	90%	100%
36"-44"	50%	65%	70%	75%	80%	100%	110%	120%

Fabric with double repeat: If using a fabric with a double repeat, please follow this formula: take the total amount of the larger and half of the smaller repeat; add together to find the correct overall repeat. Example: 10" vertical with 14" horizontal would be $14 + \frac{10}{2} = 19$.

If fabric comes in on multiple rolls, one additional yard per roll needs to be added to the yardage requirement.

Leather hides must be a minimum of 50 square feet of usable material. The outer edges cannot be calculated as square feet or yardage. To determine square footage, multiply unit yardage by 18 square feet to obtain the total square footage required per unit.

For exact production yardage requirements, call 1-800-424-2432, ext. 2707.

Production

Customer's upholstery must be approved prior to acceptance for production.

After approval, a memo swatch of the C.O.M. from the textile distributor must accompany the order. KI assumes no responsibility for wear, defects, or performance of C.O.M. or K.O.M. upholstery.

C.O.M. not received into the appropriate facility 3 weeks prior to acknowledged delivery date may go on hold. See KI C.O.M.

Shipping Location listing for the correct facility address by product.

All C.O.M. must be labeled as follows:

1. Name and address
2. Your purchase order number
3. Our style number to which fabric is to be applied
4. Supplier name and fabric name, number, and color

ALL C.O.M. Shipments must be prepaid. Collect shipments will be refused.

Testing

When KI requires testing, actual yardage to upholster one chair may be required. The C.O.M. Specialist will confirm model and fabric testing requirements when applicable.

Approved test samples will be applied to the order or will be held for 6 months. After 6 months, the sample will no longer be applied to your order. For all product testing, send fabric samples to the manufacturing facility. See KI C.O.M. Shipping Location listing for the correct facility address by product.

ALL C.O.M. Shipments must be prepaid. Collect shipments will be refused.

Treated Materials

If C.O.M. requires processing such as a stain resistance treatment or acrylic backing, it may shrink. To prevent delays in delivery or back ordering due to shrinkage, please have your processor verify measurement after processing and assure adequate yardage shipped.

Split Orders

If a portion of the shipment which does not require C.O.M. application is to be processed and shipped early, KI will enter the order immediately at your request. These split shipments are subject to minimum order changes.

Excess Upholstery Material

KI will dispose of excess upholstery material at the time of shipment unless expressly requested to return it with the product shipment.

Cancelled or Changed Orders

KI assumes no responsibility for extra C.O.M. due to a change of upholstery or cancellation of an order. If it the customer's responsibility to arrange for return of the material.

Contact the C.O.M. Specialist at 1-800-424-2432, ext. 2707, with questions or to request a split order



C.O.M. SHIPPING LOCATION

Architectural Walls	Panel Systems	Impress Ultra OM
Evoke..... MN	All Terrain..... KP	Intellect Wave GB
Genius..... MN	Balance MN	Jessa HN
	Universal MN	Jubilee VQ
Casegoods	Wireworks MN	Katera..... GB
Aristotle..... MN	Unite..... MN	Kurv Benches..... HN
Likha..... MN		Learn2..... GB
	Residence Hall Furniture	LimeLite..... GB
Classroom Furniture	RoomScape..... MN	Lyra HN
Cogni GB		Medical & Laboratory Stools..... OM
Intellect Wave GB	Screens	MyPlace HN
Learn2..... GB	All Terrain..... KP	MyWay HN
Ruckus..... GB	Connection Zone..... BW	Oath GB
	Tributaire..... BW	Opt4 GB
Desking	True/Volition KP	Pilot OM
700 Series KP	Genesis..... KP	Promenade..... BW
Balance MN	Tattoo..... MN	Ruckus..... GB
Genesis MN	Universal..... BW	Sela HN
True KP		Sift GB
Universal MN	Seating	Signia..... OM
WorkZone MN	600 Series..... BW	Soltice Metal HN
	Affina HN	Soltice HN
Files & Storage	Altus GB	Sonrisa HN
700 Series..... GB	Apply GB	Strive GB
Connection..... BW	Calida HN	Sway BW
U-Series GB	Cascha VT	Tattoo..... HN
Tattoo..... BW	Civara VT	Torsion-on-the-Go! GB
	Clamber HN	Torsion Air GB
Fixed Seating	Cogni GB	Zeker HN
Concerto..... BW	Diem OM	Zentori VT
Single Pedestal GB	Doni GB	Zoetry..... HN
Jury Base GB	Gladly VQ	
Lancaster..... BW	Grazie GB	
Sequence GB	Hub HN	
University GB	Impress OM	

KI C.O.M. Manufacturing Site Addresses:

<u>BW</u> KI Bonduel Attn: COM Storage 204 West South St. Bonduel, WI 54107	<u>HN</u> KI High Point Attn: COM Storage 217 Feld Avenue High Point, NC 27263	<u>MN</u> KI Manitowoc Attn: COM Storage 1400 S. 41st St. Manitowoc, WI 54220	<u>VQ</u> KI Attn: COM Fabrics 6892 Marlin Circle La Palma, CA 90623
<u>GB</u> KI Green Bay Attn: COM Storage 1687 Westminster Drive - Gate 3 Green Bay, WI 54302	<u>KP</u> KI Pembroke Attn: COM Storage 1000 Olympic Dr. Pembroke, Ontario K8A6X7	<u>OM</u> KI Attn: COM Storage 110 S. Mildred Ave. Ontario, CA 91761	<u>VT</u> KI Attn: COM Storage 2803 South Taylor Drive Sheboygan, WI 53081



18" Round **26" Round** **Crescent** **Square** **Cube** **Hexagon**

General Dimensions						
Seat width	18-3/4"					
Seat depth						
Seat height	18"	18"	18"	18"	18"	18"
Overall Dimensions						
Width	18" Diameter	26" Diameter	26" Diameter	26"	18"	20-3/4"
Depth			22"	26"	18"	18"
Height	18"	18"	18"	18"	18"	18"



Backless 30° Curve **Inside Back 30° Curve, 32" Low-Back** **Outside Back 30° Curve, 32" Low-Back**

General Dimensions			
Seat width	14"	14"	14"
Seat depth	19"	19"	19"
Seat height	18"	18"	18"
Overall Dimensions			
Width	28"	28"	28"
Depth	27"	27"	27"
Height	18"	32"	32"



Rectangle **Rectangle with 32" Low-Back** **Lounge Chair with 32" Low-Back** **Corner with 32" Low-Back (Right and Left)** **Five Star with 32" Low-Back**

General Dimensions					
Seat width		48"	26"	19"	19"
Seat depth		19"	19"	19"	17"
Seat height		18"	18"	18"	18"
Overall Dimensions					
Width	48"	48"	26"	26"	31-1/4"
Depth	26"	26"	26"	26"	28"
Height	18"	32"	32"	32"	32"



Backless 45° Curve **Inside Back 45° Curve, 32" Low-Back** **Outside Back 45° Curve, 32" Low-Back**

General Dimensions			
Seat width	21"	21"	21"
Seat depth	19"	19"	19"
Seat height	18"	18"	18"
Overall Dimensions			
Width	41-1/2"	41-1/2"	41-1/2"
Depth	28"	28"	28"
Height	18"	32"	32"



Backless 60° Curve



Inside Back 60° Curve, 32" Low-Back



Outside Back 60° Curve, 32" Low-Back

General Dimensions			
Seat width	28"	28"	28"
Seat depth	19"	19"	19"
Seat height	18"	18"	18"
Overall Dimensions			
Width	54"	54"	54"
Depth	30"	30"	30"
Height	18"	32"	32"



Backless 90° Curve



Inside Back 90° Curve, 32" Low-Back



Outside Back 90° Curve, 32" Low-Back

General Dimensions			
Seat width	39-3/4"	39-3/4"	39-3/4"
Seat depth	19"	19"	19"
Seat height	18"	18"	18"
Overall Dimensions			
Width	76-1/2"	76-1/2"	76-1/2"
Depth	33-1/2"	33-1/2"	33-1/2"
Height	18"	32"	32"



18" Round Table



26" Round Table



Square Table



Inline Table, Without Pad



Inline Table, With Pad

General Dimensions					
Seat width				13"	13"
Seat depth					26"
Seat height				13"	18"
Overall Dimensions					
Width	18" Diameter	26" Diameter	26"	13"	13"
Depth			26"	26"	26"
Height	18"	18"	18"	18"	18"



Junior 18" Round



Junior 26" Round

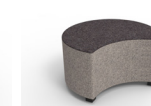

Junior Crescent

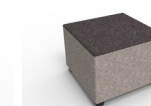

Junior Square



Junior Cube



Junior Hexagon

General Dimensions						
Seat width				18-3/4"		
Seat depth					18"	18"
Seat height	14"	14"	14"		14"	14"
Overall Dimensions						
Width	18" Diameter	26" Diameter	26" Diameter	22"	18"	21"
Depth			22"	22"	18"	18"
Height	14"	14"	14"	14"	14"	14"



Frame

All seat and backrest frames are constructed of $\frac{3}{4}$ " laminated hardwood plywood, CNC cut. All main frame joints are nailed and glued in addition to interlocking joinery across all stress points.

Foam

MyPlace backless junior models use foam that is 2.6 density, 80 lb compression with 2" thick seat. $\frac{3}{4}$ " thick foam covers all exposed sides.

The following MyPlace ottoman standard sized models use a high-density foam for firm support: MP18R, MP26R, MPCRE, MP18H, MP18C, M36R, M48R, M26H, M36H, M48H, M36CRE, M48CRE, M36SQR, and M48SQR. The foam is 2.6 density, 80 lb compression with 2" thick seat. $\frac{3}{4}$ " thick foam covers all exposed sides. The MPTEDP uses a high-density foam that is $\frac{3}{4}$ " thick, 2.6 density, 80 lb compression.

The following MyPlace backless & 32" low-back standard sized models use a soft sit high-density foam providing enhanced user comfort: MPSQR, MP5S, MPCRIV, MPICB, MPOCB, MPRCT, MPRB, MPCRIN, MPSQRL, MPC30, MPC45, MPC60, MPC130, MPC145, MPC160, MPCO30, MPCO45 and MPCO60. The foam is 2.5 density, 45 lb compression with 2 $\frac{1}{2}$ " thick seat, topped with $\frac{1}{2}$ " of 2.6 density 80 lb compression foam. The backs are 1 $\frac{1}{2}$ " total thickness consisting of 1" thick 2.5 density - 45 lb and a $\frac{1}{2}$ " topper of 2.6 density - 80 lb compression foam. $\frac{3}{4}$ " of 2.6 density, 80 lb compression foam covers all exposed sides.

Sewing

All MyPlace lounge units are double-needle stitched at all primary seams for lasting durability.

Base Options

Active Base

The active base is $\frac{1}{4}$ " thick convex molded ABS, 1 $\frac{7}{8}$ " high, and has a slip-resistant texture on the bottom. Available only in black. Available on 18" round, 18" hexagon, junior 18" round and junior 18" hexagon ottomans only.

Casters

Casters are 2" high and use 1 $\frac{1}{2}$ " diameter dual soft swivel wheels with a 150 lb weight rating per caster. They are black in color with four or five casters used per lounge depending upon model. Casters are only available non-locking. **Note:** Caster lounges cannot be ganged.

Concealed Glides

Concealed glides are height-adjustable steel, $\frac{1}{4}$ -20 threaded with a natural color nylon bottom. Glides allow for $\frac{3}{4}$ " of height adjustment, except for in-line table glides which allow for $\frac{1}{4}$ " height adjustment. Four or five glides are used per lounge depending upon model. In-line table concealed glides are adjustable, screw-in as opposed to nail-in.

Feet

Cast Aluminum Feet

Cast aluminum feet are 2" high and mounted to the underside frame using $\frac{5}{16}$ -18 x 1 $\frac{1}{2}$ " set screws. Feet are offered in brushed aluminum or finished in powder-coat paint with four or five feet used per lounge, depending upon model. A height-adjustable steel $\frac{1}{4}$ -20 threaded, natural color, impact resistant nylon glide bottom allows for $\frac{3}{4}$ " of leveling. See KI Color Addendum for paint color offering. Cast aluminum feet are not available on MyPlace Junior models.

Poly Feet

Poly feet are 2" high polyurethane, and contain an adjustable glide. The height-adjustable steel $\frac{1}{4}$ -20 threaded, natural color, impact resistant nylon glide bottom allows for $\frac{3}{4}$ " of leveling. Poly feet are mounted to the underside frame using $\frac{5}{16}$ -18 x 1 $\frac{1}{2}$ " set screws. Feet are black in color with four or five feet used per lounge, depending upon model.

Wood Feet

Wood feet are 2" high and made from 2" x 2" x 2" Beech hardwood, kiln dried to a moisture content of 6%. Exposed wood is sanded with 220 grit sand paper, then spray stained with KI standard colors, or a non-standard color match and placed in a burn-off oven for one hour at 140-150 degrees. The wood is then sealed to prevent moisture imbalance and finish sanded with 400 grit sand paper for fine detailing. The final step for wood feet is the application of a varnish topcoat, then feet are oven baked. Both the sealer and finish coats contain an anti-microbial protectant. A height-adjustable steel $\frac{1}{4}$ -20 threaded, natural color, impact resistant nylon glide bottom allows for $\frac{3}{4}$ " of leveling. Four to five wood feet are used per lounge depending upon model. See KI color addendum for stain color offering.

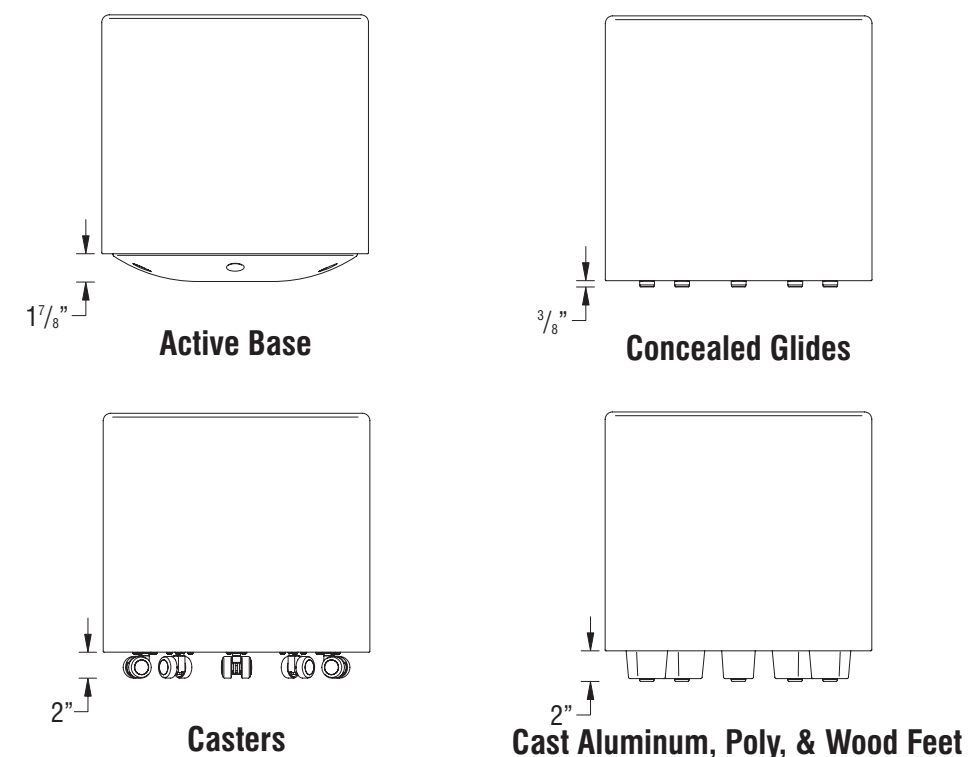



Ganging

Backless, 32" low-back & table gangers are made from 10-gauge steel ($\frac{1}{8}$ " thick), powder-coated black and mounted to the underside of any lounge using #14 x 1" wood screws. Only the feet and concealed glide base options are available to use gangers.

Electrical System

Byrne Mini-Tap® Power Module with 3-Prong Plug

MyPlace backless lounges and 32" low-back standard size lounges can be configured with optional Byrne Mini-Tap® power modules with 3-prong plug (a self-contained, UL listed single relocatable power tap). One 15-amp, 125 volt AC simplex receptacle with one 2.1-amp, 5 volt DC USB-A port, and one USB-C port (2.0 and 3.0 compatible, no data), provide connection for device charging or direct AC power. Byrne Mini-Tap® power module is standard with 72" long, 14 AWG, 15-amp NEMA rated 3-conductor SJT cord with a three-prong grounded plug. The 3-prong plug is oriented straight off the power cord. Faceplates are optionally either black in color with black outlet ports, white with white outlet ports, or silver with black outlet ports. Cord is black.

One Byrne Mini-Tap® power module with 3-prong plug is available per model. See MyPlace Lounge Furniture - Planning Guide (KI-PG-000020) for configurable power locations.

MyPlace Ottomans

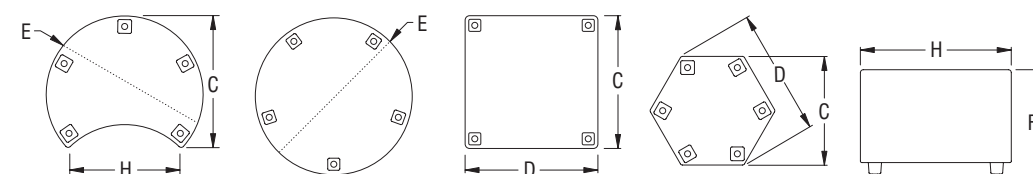

Ottomans - Overall Dimensions

Model	A (Back Depth)	B (Seat Depth)	C (Overall Depth)	D (Overall Width)	E (Diameter)	F (Overall Height)	G (Seat Height)	H (Seat Width)
MP18R					18"	18"	18"	
MP26R					26"	18"	18"	
M36R					36"	18"	18"	
M48R					48"	18"	18"	
MPCRE			22"		26"	18"	18"	18 $\frac{3}{4}$ "
MCRE36			29 $\frac{1}{4}$ "		36"	18"	18"	36"
MCRE48			37 $\frac{1}{8}$ "		48"	18"	18"	48"
MP18H		18"	18"	20 $\frac{3}{4}$ "		18"	18"	
M26H		26"	26"	30"		18"	18"	
M36H		36"	36"	41 $\frac{1}{2}$ "		18"	18"	
M48H		48"	48"	55 $\frac{3}{8}$ "		18"	18"	
MP18C		18"	18"	18"		18"	18"	
MPSQR		26"	26"	26"		18"	18"	
MC36		36"	36"	36"		18"	18"	
MC48		47 $\frac{1}{2}$ "	47 $\frac{1}{2}$ "	47 $\frac{1}{2}$ "		18"	18"	

Junior Ottomans - Overall Dimensions

Model	A (Back Depth)	B (Seat Depth)	C (Overall Depth)	D (Overall Width)	E (Diameter)	F (Overall Height)	G (Seat Height)	H (Seat Width)
MPJ18R					18"	14"	14"	
MPJ26R					26"	14"	14"	
MPJCRE			22"		26"	14"	14"	18 $\frac{3}{4}$ "
MPJ18H		18"	18"	21"		14"	14"	
MPJ18C		18"	18"	18"		14"	14"	
MPJSQR		22"	22"	22"		14"	14"	



MyPlace 32" Low-Back Lounges

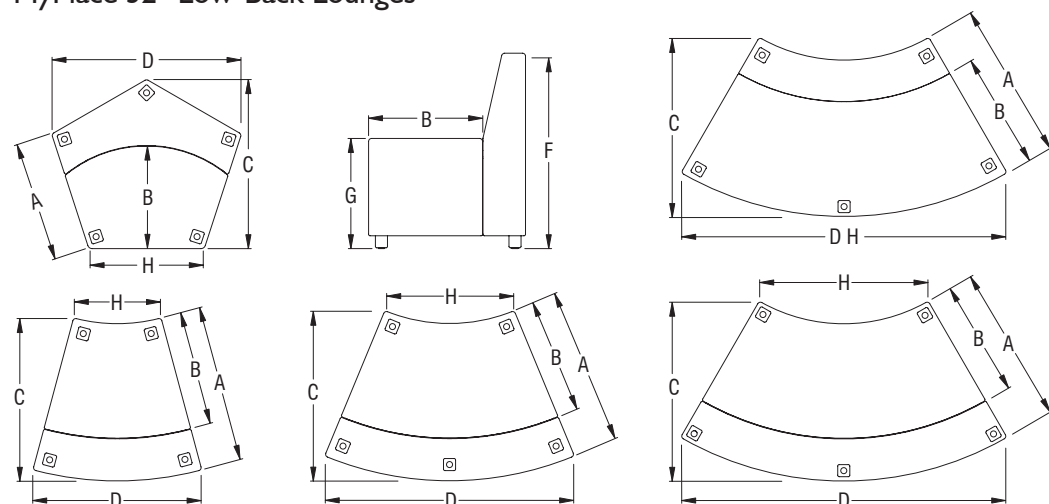

32" Low-Back Lounge Overall Dimension								
Model	A (Back Depth)	B (Seat Depth)	C (Overall Depth)	D (Overall Width)	E (Diameter)	F (Overall Height)	G (Seat Height)	H (Seat Width)
MPSQRL	26"	19"	26"			32"	18"	
MPRB	26"	19"	26"	48"		32"	18"	
MPCRN	26"	19"	26"	26"		32"	18"	
MP55	20"	17"	28"	31 1/4"		32"	18"	19"
MPCI30	26"	19"	27"	28"		32"	18"	14"
MPCI45	26"	19"	28"	41 1/2"		32"	18"	21"
MPCI60	26"	19"	30"	54"		32"	18"	28"
MPICB	26"	19"	33 1/2"	76 1/2"		32"	18"	39 3/4"
MPCO30	26"	19"	27"	28"		32"	18"	14"
MPCO45	26"	19"	28"	41 1/2"		32"	18"	21"
MPCO60	26"	19"	30"	54"		32"	18"	28"
MPOCB	26"	19"	33 1/2"	76 1/2"		32"	18"	39 3/4"

MyPlace Backless Lounges

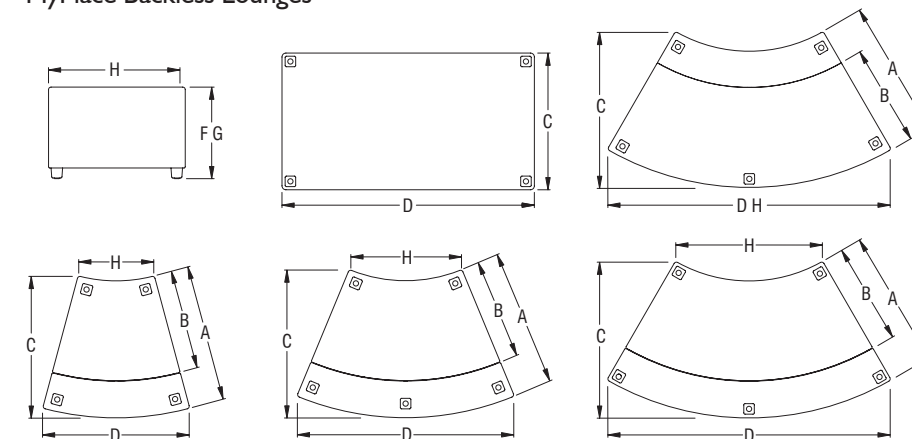

Backless Lounges - Overall Dimension								
Model	A (Back Depth)	B (Seat Depth)	C (Overall Depth)	D (Overall Width)	E (Diameter)	F (Overall Height)	G (Seat Height)	H (Seat Width)
MPRCT		26"	26"	48"		18"	18"	
MPC30			27"	28"		18"	18"	14"
MPC45			28"	41 1/2"		18"	18"	21"
MPC60			30"	54"		18"	18"	28"
MPCRV			33 1/2"	76 1/2"		18"	18"	39 3/4"



Brushed Aluminum Feet

Black	BL	Dove Grey	LDG
Blue Grey	GR	Florence Walnut	LFC
Bronze Metallic	ZM	Friston Ash	LFH
Brushed aluminum legs	BRAL	Frosty White	LFW
Cayenne	CY	Graphite Nebula	LGN
Champagne Metallic	CM	Grey	LGE
Cool Grey	CG	High Rise	LHE
Cottonwood	CO	Hollyberry	LHY
Earthen Clay	EY	Island	LID
Espresso Metallic	EX	Italian Silver Ash	LIT
Everglade Shade	EV	Kensington Maple	LKM
Flannel	FN	Lapis Blue	LLB
Glitz Metallic	GZ	Monticello Maple	LMT
Hazy Jade	HJ	North Sea	LNA
Honey Bee	HY	Ocean	LON
Light Tone	LG	Pinnacle Walnut	LPW
Mardi Gras	MG	River Cherry	LRY
Misty Brown	MY	Shadow Zephyr	LSR
Nemo	NE	Sterling Ash	LAZ
Nordic	ND	Titanium Evolv	LTV
Poppy Red	PR	White Nebula	LWL
Purple Haze	PH	White Sand	LWN
Rainforest	RQ	Windsor Mahogany	LWY
Raw Jasper	RJ		
Rubber Ducky	RK		
Sand	SA		
Sky Blue	SK		
Starlight Silver Metallic	SX		
Surf's Up	SP		
Tarragon	TQ		
Twilight Shadow	TI		
Ultra Blue	UB		
Warm Grey	WG		
Zesty Lime	ZL		

Table Top Surface Finish--Grade 2 Standard Laminate

Akira	LAK
Black Alicante	LBY
Black Hills Oak	LBH
Calcutta Marble	LCQ
Dering Forest	LDF
Fawn Cypress	LFQ
Ice Mist	LIM
Markerboard White	LMK
Valley Forge Elm	LVF
White River Forest	LWR

Table Top Surface Finish--Grade 3 Standard Laminate

Black Velvet	LBV
Cumberland Walnut	LCJ
Designer White Velvet	LDE
Hartley Walnut	LHW
Nile Velvet	LNL
Raleigh Walnut	LRW
Solano Walnut	LSG
Spruce Velvet	LSC

Table Top Edge Color - 73P and 74P Edges

Akira	EAK
Beigewood	EBZ
Belair	EBQ
Biltmore Cherry	EBT
Black	EBL
Brighton Walnut	EBH
Black Hills Oak	EBG
Blue Grey	EGR
Brighton Walnut	EBW
Castle Oak	ECO
Cayenne	ECY
Cherry Storm	ECX

Cocobala	ECC	Frosty White	ECG
Cool Grey	ECJ	Graphite Nebula	EDF
Cumberland Walnut	EDR	Grey	EEV
Dering Forest	EFQ	High Rise	EFN
Designer White	EFC	Hollyberry	EFH
Everglade Shade	EFW	Island	EFJ
Fawn Cypress	EFN	Italian Silver Ash	EFK
Flannel	EHW	Kensington Maple	ELG
Florence Walnut	EHJ	Lapis Blue	EMG
Friston Ash	EIT	Markerboard White	EMY
Frosty White	EKM	Monticello Maple	EMT
Hartley Walnut	ELG	North Sea	EMB
Hazy Jade	EMG	Ocean	ENE
Italian Silver Ash	EMY	Pinnacle Walnut	END
Kensington Maple	EKT	River Cherry	EPW
Light Tone	ELG	Shadow Zephyr	EPR
Mardi Gras	EMG	Sterling Ash	ERQ
Misty Brown	EMY	Titanium Evolv	ERW
Monticello Maple	EMT	White Nebula	ERY
Multiplex	EMB	White Sand	ERK
Nemo	ENE	Windsor Mahogany	ESA
Nordic	END		ESK
Pinnacle Walnut	EPW		ESG
Poppy Red	EPR		EAZ
Rainforest	ERQ		ESP
Raleigh Walnut	ERW		ETQ
River Cherry	ERY		ETI
Rubber Ducky	ERK		EUB
Sand	ESA		EVF
Sky Blue	ESK		EWG
Solano Walnut	ESG		EWR
Sterling Ash	EAZ		EWY
Surf's Up	ESP		EZL
Tarragon	ETQ		
Twilight Shadow	ETI		
Ultra Blue	EUB		
Valley Forge Elm	EVF		
Warm Grey	EWG		
White River Forest	EWR		
Windsor Mahogany	EWY		
Zesty Lime	EZL		

Side and Divider Color - Laminate (models MPTEDP and MYPTED)

Beigewood	LLBZ
Belair	LBQS
Biltmore Cherry	LBTS
Black	LBKS
Brighton Walnut	LBWS
Castle Oak	LCOS
Cherry Storm	LCXS
Classic Linen	LCIS
Cocobala	LCOS
Crisp Linen	LRIS
Designer White	LLDR
Dove Grey	LDGS
Florence Walnut	LFCS
Friston Ash	LFHS

Frosty White	LFWS	Rainforest	SRQ
Graphite Nebula	LGNS	Raleigh Walnut	SRW
Grey	LGES	River Cherry	SRY
High Rise	LHES	Rubber Ducky	SRK
Hollyberry	LHYS	Sand	SSA
Island	LIDS	Sky Blue	SSK
Italian Silver Ash	LITS	Solano Walnut	SSG
Kensington Maple	LKMS	Sterling Ash	SAZ
Lapis Blue	LLBS	Surf's Up	SSP
Markerboard White	LMKS	Tarragon	STQ
Monticello Maple	LMTS	Twilight Shadow	STI
North Sea	LNAS	Ultra Blue	SUB
Ocean	LONS	Valley Forge Elm	SVF
Pinnacle Walnut	LPWS	Warm Grey	SWG
River Cherry	LRYS	White River Forest	SWR
Shadow Zephyr	LSRS	Windsor Mahogany	SWY
Sterling Ash	LAZS	Zesty Lime	SZL
Titanium Evolv	LTVS		
White Nebula	LWLS		
White Sand	LWNS		
Windsor Mahogany	LWYS		

Side and Divider Edge Color - 73P Edge (models MPTEDP and MYPTED)

Akira	SAK
Beigewood	SBZ
Belair	SBQ
Biltmore Cherry	SBT
Black	SBL
Black Hills Oak	SBH
Blue Grey	SGR
Brighton Walnut	SBW
Castle Oak	SCO
Cayenne	SCY
Cherry Storm	SCX
Cocobala	SCC
Cool Grey	SCG
Cumberland Walnut	SCJ
Dering Forest	SDF
Designer White	SDR
Everglade Shade	SEV
Fawn Cypress	SFQ
Flannel	SFN
Florence Walnut	SFC
Friston Ash	SFH
Frosty White	SFW
Hartley Walnut	SHW
Hazy Jade	SHJ
Italian Silver Ash	SIT
Kensington Maple	SKM
Light Tone	SLG
Mardi Gras	SMG
Misty Brown	SMY
Monticello Maple	SMT
Multiplex	SMB
Nemo	SNE
Nordic	SND
Pinnacle Walnut	SPW

Oak Finish (Curved Shelving Units only)

Brighton Walnut on Oak	VBW
Castle Oak on Oak	VOK
Cinnamon on Oak	OCN
Cocoa on Oak	OCA
Florence Walnut on Oak	OFC
Medium on Oak	SMD
River Cherry on Oak	ORY

Maple Finish (Curved Shelving Units only)

Cherry Storm on Maple	MCX
Cinnamon on Maple	MCN
Cocoa on Maple	MCA
Florence Walnut on Maple	MFC
Kensington Maple on Maple	MMA
Monticello Maple on Maple	MMT
River Cherry on Maple	MRY

Thermally Fused Laminate Finish (Curved Shelving Units Only)

Biltmore Cherry	TFLBT
Bright White	TFLBR
Canadian Gray	TFLCY
Classic Black	TFLCB
Classic Maple	TFLCM
Looks Likatré	TFLLL

Finish Cards

View color swatches for items listed within this document.

Paints	Wood/Veneer	Molded Edges	Hard Plastics
Plastics/Poly	Laminates	Edge Styles	Glass

Certain options referenced may not be available on GSA Schedule.



Features	MODEL NUMBER						Approx. Packaged Weight	Delivered Pricing	Moisture Barrier add to list price	
	Basic Model	Non-Contrast or Fabric Contrast 1	Fabric Contrast 2	Wood Feet Finish	Aluminum Feet Finish	Moisture Barrier				
concealed glides shown M18R 18" Round - Non-contrast • Non-contrast C.O.M = 1.25 yds • Dia=18" H=18"	Concealed Glide, Non-contrast	MP18R/CGL/NC	<input type="checkbox"/> <input type="checkbox"/> <input type="checkbox"/> <input type="checkbox"/>				<input type="checkbox"/> <input type="checkbox"/>	30.00#	\$ 667	\$ 108
	Poly Feet, Non-contrast	MP18R/PFT/NC	<input type="checkbox"/> <input type="checkbox"/> <input type="checkbox"/> <input type="checkbox"/>				<input type="checkbox"/> <input type="checkbox"/>	30.00#	667	108
	Wood Feet, Non-contrast	MP18R/WFT/NC	<input type="checkbox"/> <input type="checkbox"/> <input type="checkbox"/> <input type="checkbox"/>		<input type="checkbox"/> <input type="checkbox"/>		<input type="checkbox"/> <input type="checkbox"/>	30.00#	796	108
	Casters, Non-contrast	MP18R/CST/NC	<input type="checkbox"/> <input type="checkbox"/> <input type="checkbox"/> <input type="checkbox"/>				<input type="checkbox"/> <input type="checkbox"/>	30.00#	667	108
	Aluminum Feet, Non-Contrast	MP18R/AFT/NC	<input type="checkbox"/> <input type="checkbox"/> <input type="checkbox"/> <input type="checkbox"/>			<input type="checkbox"/> <input type="checkbox"/>	<input type="checkbox"/> <input type="checkbox"/>	35.00#	803	108
	Active Base, Non-contrast	MP18R/ABO/NC	<input type="checkbox"/> <input type="checkbox"/> <input type="checkbox"/> <input type="checkbox"/>				<input type="checkbox"/> <input type="checkbox"/>	30.00#	765	108
concealed glides shown M18R 18" Round - Contrast • 1 = Base (Fabric Contrast 1) C.O.M. = 1.25 yd • 2 = Seat (Fabric Contrast 2) C.O.M. = .75 yd • Dia=18" H=18"	Concealed Glide, Contrast	MP18R/CGL/FC	<input type="checkbox"/> <input type="checkbox"/> <input type="checkbox"/> <input type="checkbox"/>	<input type="checkbox"/> <input type="checkbox"/> <input type="checkbox"/> <input type="checkbox"/>			<input type="checkbox"/> <input type="checkbox"/>	30.00#	\$ 699	\$ 108
	Poly Feet, Contrast	MP18R/PFT/FC	<input type="checkbox"/> <input type="checkbox"/> <input type="checkbox"/> <input type="checkbox"/>	<input type="checkbox"/> <input type="checkbox"/> <input type="checkbox"/> <input type="checkbox"/>			<input type="checkbox"/> <input type="checkbox"/>	30.00#	699	108
	Wood Feet, Contrast	MP18R/WFT/FC	<input type="checkbox"/> <input type="checkbox"/> <input type="checkbox"/> <input type="checkbox"/>	<input type="checkbox"/> <input type="checkbox"/> <input type="checkbox"/> <input type="checkbox"/>	<input type="checkbox"/> <input type="checkbox"/>		<input type="checkbox"/> <input type="checkbox"/>	30.00#	828	108
	Casters, Contrast	MP18R/CST/FC	<input type="checkbox"/> <input type="checkbox"/> <input type="checkbox"/> <input type="checkbox"/>	<input type="checkbox"/> <input type="checkbox"/> <input type="checkbox"/> <input type="checkbox"/>			<input type="checkbox"/> <input type="checkbox"/>	30.00#	699	108
	Aluminum Feet, Contrast	MP18R/AFT/FC	<input type="checkbox"/> <input type="checkbox"/> <input type="checkbox"/> <input type="checkbox"/>	<input type="checkbox"/> <input type="checkbox"/> <input type="checkbox"/> <input type="checkbox"/>		<input type="checkbox"/> <input type="checkbox"/>	<input type="checkbox"/> <input type="checkbox"/>	35.00#	835	108
	Active Base, Contrast	MP18R/ABO/FC	<input type="checkbox"/> <input type="checkbox"/> <input type="checkbox"/> <input type="checkbox"/>	<input type="checkbox"/> <input type="checkbox"/> <input type="checkbox"/> <input type="checkbox"/>			<input type="checkbox"/> <input type="checkbox"/>	30.00#	791	108
			A	B	C	D	E	F		

HOW TO ORDER

- Indicate the following information on order form:
- Quantity of each item.
 - Model number, including options. See "How To Build a Model Number".
 - Any special service required.

Note:

- The indicates that a choice is required.
- The absence of the indicates that no choice is required.
- Alpha-numeric characters in place of indicate that no other alternatives are available.

HOW TO BUILD A MODEL NUMBER

See pricing column for moisture barrier upcharge.

- A** Select basic model.
- B** Select non-contrast or fabric contrast 1. Refer to ki.com/fabrics.
 - For yardage pricing, see Fabric Yardage Pricing page
- C** Select fabric contrast 2. Refer to ki.com/fabrics.
 - For yardage pricing, see Fabric Yardage Pricing page
- D** Select wood feet finish. Refer to the **Product Color Options** page in this price list.
- E** Select brushed aluminum feet finish. Refer to the **Product Color Options** page in this price list.
- F** Select moisture barrier.
 - MB** - Moisture barrier
 - NMB** - No moisture barrier

SPECIAL SERVICES

Special Carton Marking

With specially marked information N/C

Shipping

Ships **assembled, FOB High Point, NC 27263, freight prepaid.** Freight class 250.

Specifications and prices are subject to change without prior notice.

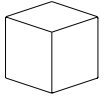
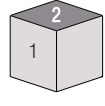

Features	MODEL NUMBER						Approx. Packaged Weight	Delivered Pricing	Moisture Barrier add to list price	
	Basic Model	Non-Contrast or Fabric Contrast 1	Fabric Contrast 2	Wood Feet Finish	Aluminum Feet Finish	Moisture Barrier				
concealed glides shown 	Concealed Glides, Non-contrast	MP18C/CGL/NC	<input type="checkbox"/> <input type="checkbox"/> <input type="checkbox"/> <input type="checkbox"/>				<input type="checkbox"/> <input type="checkbox"/>	26.50#	\$ 760	\$ 196
	Poly Feet, Non-contrast	MP18C/PFT/NC	<input type="checkbox"/> <input type="checkbox"/> <input type="checkbox"/> <input type="checkbox"/>				<input type="checkbox"/> <input type="checkbox"/>	25.50#	760	196
	Wood Feet, Non-contrast	MP18C/WFT/NC	<input type="checkbox"/> <input type="checkbox"/> <input type="checkbox"/> <input type="checkbox"/>		<input type="checkbox"/> <input type="checkbox"/>		<input type="checkbox"/> <input type="checkbox"/>	25.50#	892	196
	Casters, Non-contrast	MP18C/CST/NC	<input type="checkbox"/> <input type="checkbox"/> <input type="checkbox"/> <input type="checkbox"/>				<input type="checkbox"/> <input type="checkbox"/>	25.50#	760	196
	Aluminum Feet, Non-Contrast	MP18C/AFT/NC	<input type="checkbox"/> <input type="checkbox"/> <input type="checkbox"/> <input type="checkbox"/>			<input type="checkbox"/> <input type="checkbox"/>	<input type="checkbox"/> <input type="checkbox"/>	25.50#	899	196
M18C 18" Cube - Non-contrast • Non-contrast C.O.M = 1.75 yds Overall Dimensions: • W=18" D=18" H=18"										
concealed glides shown 	Concealed Glides, Contrast	MP18C/CGL/FC	<input type="checkbox"/> <input type="checkbox"/> <input type="checkbox"/> <input type="checkbox"/>	<input type="checkbox"/> <input type="checkbox"/> <input type="checkbox"/> <input type="checkbox"/>			<input type="checkbox"/> <input type="checkbox"/>	26.50#	\$ 789	\$ 196
	Poly Feet, Contrast	MP18C/PFT/FC	<input type="checkbox"/> <input type="checkbox"/> <input type="checkbox"/> <input type="checkbox"/>	<input type="checkbox"/> <input type="checkbox"/> <input type="checkbox"/> <input type="checkbox"/>			<input type="checkbox"/> <input type="checkbox"/>	25.50#	789	196
	Wood Feet, Contrast	MP18C/WFT/FC	<input type="checkbox"/> <input type="checkbox"/> <input type="checkbox"/> <input type="checkbox"/>	<input type="checkbox"/> <input type="checkbox"/> <input type="checkbox"/> <input type="checkbox"/>	<input type="checkbox"/> <input type="checkbox"/>		<input type="checkbox"/> <input type="checkbox"/>	25.50#	924	196
	Casters, Contrast	MP18C/CST/FC	<input type="checkbox"/> <input type="checkbox"/> <input type="checkbox"/> <input type="checkbox"/>	<input type="checkbox"/> <input type="checkbox"/> <input type="checkbox"/> <input type="checkbox"/>			<input type="checkbox"/> <input type="checkbox"/>	25.50#	789	196
	Aluminum Feet, Contrast	MP18C/AFT/FC	<input type="checkbox"/> <input type="checkbox"/> <input type="checkbox"/> <input type="checkbox"/>	<input type="checkbox"/> <input type="checkbox"/> <input type="checkbox"/> <input type="checkbox"/>		<input type="checkbox"/> <input type="checkbox"/>	<input type="checkbox"/> <input type="checkbox"/>	25.50#	899	196
M18C 18" Cube - Contrast • 1 = Base (Fabric Contrast 1) C.O.M. = 1.25 yd • 2 = Seat (Fabric Contrast 2) C.O.M. = .75 yd Overall Dimensions: • W=18" D=18" H=18"										
	A	B	C	D	E	F				

HOW TO ORDER

Indicate the following information on order form:

- Quantity of each item.
- Model number, including options. See "How To Build a Model Number".
- Any special service required.

Note:

- The indicates that a choice is required.
- The absence of the indicates that no choice is required.
- Alpha-numeric characters in place of indicate that no other alternatives are available.

HOW TO BUILD A MODEL NUMBER

See pricing column for moisture barrier upcharge.

A Select basic model.

B Select non-contrast or fabric contrast 1. Refer to ki.com/fabrics.
 • For yardage pricing, see Fabric Yardage Pricing page

C Select fabric contrast 2. Refer to ki.com/fabrics.
 • For yardage pricing, see Fabric Yardage Pricing page

D Select wood feet finish. Refer to the **Product Color Options** page in this price list.

E Select brushed aluminum feet finish. Refer to the **Product Color Options** page in this price list.

F Select moisture barrier.
MB - Moisture barrier
NMB - No moisture barrier

SPECIAL SERVICES

Special Carton Marking
 With specially marked information N/C

Shipping
 Ships assembled, FOB High Point, NC 27263, freight prepaid. Freight class 250.

Specifications and prices are subject to change without prior notice.



Features	MODEL NUMBER						Approx. Packaged Weight	Delivered Pricing	Moisture Barrier add to list price	
	Basic Model	Non-Contrast or Fabric Contrast 1	Fabric Contrast 2	Wood Feet Finish	Aluminum Feet Finish	Moisture Barrier				
concealed glides shown M18H 18" Hexagon - Non-contrast • Non-contrast C.O.M = 1.5 yds Overall Dimensions: • W=20.75" D=18" H=18"	Concealed Glides, Non-contrast	MP18H/CGL/NC	<input type="checkbox"/> <input type="checkbox"/> <input type="checkbox"/> <input type="checkbox"/>				<input type="checkbox"/> <input type="checkbox"/> <input type="checkbox"/>	26.50#	\$ 760	\$ 194
	Poly Feet, Non-contrast	MP18H/PFT/NC	<input type="checkbox"/> <input type="checkbox"/> <input type="checkbox"/> <input type="checkbox"/>				<input type="checkbox"/> <input type="checkbox"/> <input type="checkbox"/>	25.50#	760	194
	Wood Feet, Non-contrast	MP18H/WFT/NC	<input type="checkbox"/> <input type="checkbox"/> <input type="checkbox"/> <input type="checkbox"/>		<input type="checkbox"/> <input type="checkbox"/>		<input type="checkbox"/> <input type="checkbox"/> <input type="checkbox"/>	25.50#	892	194
	Casters, Non-contrast	MP18H/CST/NC	<input type="checkbox"/> <input type="checkbox"/> <input type="checkbox"/> <input type="checkbox"/>				<input type="checkbox"/> <input type="checkbox"/> <input type="checkbox"/>	25.50#	760	194
	Aluminum Feet, Non-Contrast	MP18H/AFT/NC	<input type="checkbox"/> <input type="checkbox"/> <input type="checkbox"/> <input type="checkbox"/>			<input type="checkbox"/> <input type="checkbox"/>	<input type="checkbox"/> <input type="checkbox"/> <input type="checkbox"/>	25.50#	899	194
	Active Base, Non-contrast	MP18H/ABO/NC	<input type="checkbox"/> <input type="checkbox"/> <input type="checkbox"/> <input type="checkbox"/>				<input type="checkbox"/> <input type="checkbox"/> <input type="checkbox"/>	26.50#	873	194
concealed glides shown M18H 18" Hexagon - Contrast • 1 = Base (Fabric Contrast 1) C.O.M. = 1.25 yd • 2 = Seat (Fabric Contrast 2) C.O.M. = .75 yd Overall Dimensions: • W=20.75" D=18" H=18"	Concealed Glides, Contrast	MP18H/CGL/FC	<input type="checkbox"/> <input type="checkbox"/> <input type="checkbox"/> <input type="checkbox"/>	<input type="checkbox"/> <input type="checkbox"/> <input type="checkbox"/> <input type="checkbox"/>			<input type="checkbox"/> <input type="checkbox"/> <input type="checkbox"/>	25.50#	\$ 789	\$ 194
	Poly Feet, Contrast	MP18H/PFT/FC	<input type="checkbox"/> <input type="checkbox"/> <input type="checkbox"/> <input type="checkbox"/>	<input type="checkbox"/> <input type="checkbox"/> <input type="checkbox"/> <input type="checkbox"/>			<input type="checkbox"/> <input type="checkbox"/> <input type="checkbox"/>	25.50#	789	194
	Wood Feet, Contrast	MP18H/WFT/FC	<input type="checkbox"/> <input type="checkbox"/> <input type="checkbox"/> <input type="checkbox"/>	<input type="checkbox"/> <input type="checkbox"/> <input type="checkbox"/> <input type="checkbox"/>	<input type="checkbox"/> <input type="checkbox"/>		<input type="checkbox"/> <input type="checkbox"/> <input type="checkbox"/>	25.50#	924	194
	Casters, Contrast	MP18H/CST/FC	<input type="checkbox"/> <input type="checkbox"/> <input type="checkbox"/> <input type="checkbox"/>	<input type="checkbox"/> <input type="checkbox"/> <input type="checkbox"/> <input type="checkbox"/>			<input type="checkbox"/> <input type="checkbox"/> <input type="checkbox"/>	25.50#	789	194
	Aluminum Feet, Contrast	MP18H/AFT/FC	<input type="checkbox"/> <input type="checkbox"/> <input type="checkbox"/> <input type="checkbox"/>	<input type="checkbox"/> <input type="checkbox"/> <input type="checkbox"/> <input type="checkbox"/>		<input type="checkbox"/> <input type="checkbox"/>	<input type="checkbox"/> <input type="checkbox"/> <input type="checkbox"/>	25.50#	899	194
	Active Base, Contrast	MP18H/ABO/FC	<input type="checkbox"/> <input type="checkbox"/> <input type="checkbox"/> <input type="checkbox"/>	<input type="checkbox"/> <input type="checkbox"/> <input type="checkbox"/> <input type="checkbox"/>			<input type="checkbox"/> <input type="checkbox"/> <input type="checkbox"/>	26.50#	898	194
			A	B	C	D	E	F		

HOW TO ORDER

- Indicate the following information on order form:
- Quantity of each item.
 - Model number, including options. See "How To Build a Model Number".
 - Any special service required.

Note:

- The indicates that a choice is required.
- The absence of the indicates that no choice is required.
- Alpha-numeric characters in place of indicate that no other alternatives are available.

HOW TO BUILD A MODEL NUMBER

See pricing column for moisture barrier upcharge.

- A** Select basic model.
- B** Select non-contrast or fabric contrast 1. Refer to ki.com/fabrics.
• For yardage pricing, see Fabric Yardage Pricing page
- C** Select fabric contrast 2. Refer to ki.com/fabrics.
• For yardage pricing, see Fabric Yardage Pricing page
- D** Select wood feet finish. Refer to the **Product Color Options** page in this price list.
- E** Select brushed aluminum feet finish. Refer to the **Product Color Options** page in this price list.
- F** Select moisture barrier.
MB - Moisture barrier
NMB - No moisture barrier

SPECIAL SERVICES

Special Carton Marking

With specially marked information N/C

Shipping

Ships assembled, FOB High Point, NC 27263, freight prepaid. Freight class 250.

Specifications and prices are subject to change without prior notice.



Features	MODEL NUMBER						Approx. Packaged Weight	Delivered Pricing	Moisture Barrier add to list price	
	Basic Model	Non-Contrast or Fabric Contrast 1	Fabric Contrast 2	Wood Feet Finish	Alum-inum Feet Finish	Moisture Barrier				
concealed glides shown 	Concealed Glide, Non-contrast	MP26R/CGL/NC	<input type="checkbox"/> <input type="checkbox"/> <input type="checkbox"/> <input type="checkbox"/>				<input type="checkbox"/> <input type="checkbox"/>	35.00#	\$ 797	\$ 153
	Poly Feet, Non-contrast	MP26R/PFT/NC	<input type="checkbox"/> <input type="checkbox"/> <input type="checkbox"/> <input type="checkbox"/>				<input type="checkbox"/> <input type="checkbox"/>	35.00#	797	153
	Wood Feet, Non-contrast	MP26R/WFT/NC	<input type="checkbox"/> <input type="checkbox"/> <input type="checkbox"/> <input type="checkbox"/>		<input type="checkbox"/> <input type="checkbox"/>		<input type="checkbox"/> <input type="checkbox"/>	35.00#	928	153
	Casters, Non-contrast	MP26R/CST/NC	<input type="checkbox"/> <input type="checkbox"/> <input type="checkbox"/> <input type="checkbox"/>				<input type="checkbox"/> <input type="checkbox"/>	35.00#	797	153
	Aluminum Feet, Non-Contrast	MP26R/AFT/NC	<input type="checkbox"/> <input type="checkbox"/> <input type="checkbox"/> <input type="checkbox"/>			<input type="checkbox"/> <input type="checkbox"/>	<input type="checkbox"/> <input type="checkbox"/>	35.00#	936	153
M26R 26" Round - Non-contrast • Non-contrast C.O.M = 2.25 yds • Ganging (specify kit separately) • Dia=26" H=18"										
concealed glides shown 	Concealed Glide, Contrast	MP26R/CGL/FC	<input type="checkbox"/> <input type="checkbox"/> <input type="checkbox"/> <input type="checkbox"/>	<input type="checkbox"/> <input type="checkbox"/> <input type="checkbox"/> <input type="checkbox"/>			<input type="checkbox"/> <input type="checkbox"/>	35.00#	\$ 829	\$ 153
	Poly Feet, Contrast	MP26R/PFT/FC	<input type="checkbox"/> <input type="checkbox"/> <input type="checkbox"/> <input type="checkbox"/>	<input type="checkbox"/> <input type="checkbox"/> <input type="checkbox"/> <input type="checkbox"/>			<input type="checkbox"/> <input type="checkbox"/>	35.00#	829	153
	Wood Feet, Contrast	MP26R/WFT/FC	<input type="checkbox"/> <input type="checkbox"/> <input type="checkbox"/> <input type="checkbox"/>	<input type="checkbox"/> <input type="checkbox"/> <input type="checkbox"/> <input type="checkbox"/>	<input type="checkbox"/> <input type="checkbox"/>		<input type="checkbox"/> <input type="checkbox"/>	35.00#	959	153
	Casters, Contrast	MP26R/CST/FC	<input type="checkbox"/> <input type="checkbox"/> <input type="checkbox"/> <input type="checkbox"/>	<input type="checkbox"/> <input type="checkbox"/> <input type="checkbox"/> <input type="checkbox"/>			<input type="checkbox"/> <input type="checkbox"/>	35.00#	829	153
	Aluminum Feet, Contrast	MP26R/AFT/FC	<input type="checkbox"/> <input type="checkbox"/> <input type="checkbox"/> <input type="checkbox"/>	<input type="checkbox"/> <input type="checkbox"/> <input type="checkbox"/> <input type="checkbox"/>		<input type="checkbox"/> <input type="checkbox"/>	<input type="checkbox"/> <input type="checkbox"/>	35.00#	967	153
M26R 26" Round - Contrast • 1 = Base (Fabric Contrast 1) C.O.M. = 1.75 yd • 2 = Seat (Fabric Contrast 2) C.O.M. = 1 yd • Ganging (specify kit separately) • Dia=26" H=18"										
A B C D E F										

HOW TO ORDER

Indicate the following information on order form:

- Quantity of each item.
- Model number, including options. See "How To Build a Model Number".
- Any special service required.

Note:

- The indicates that a choice is required.
- The absence of the indicates that no choice is required.
- Alpha-numeric characters in place of indicate that no other alternatives are available.

HOW TO BUILD A MODEL NUMBER

A Select basic model.

B Select non-contrast or fabric contrast 1.
Refer to ki.com/fabrics.
• For yardage pricing, see Fabric Yardage Pricing page

C Select fabric contrast 2.
Refer to ki.com/fabrics.
• For yardage pricing, see Fabric Yardage Pricing page

D Select wood feet finish.
Refer to the **Product Color Options** page in this price list.

E Select brushed aluminum feet finish.
Refer to the **Product Color Options** page in this price list.

F Select moisture barrier.
MB - Moisture barrier
NMB - No moisture barrier
See pricing column for moisture barrier upcharge.

SPECIAL SERVICES

Special Carton Marking
With specially marked information N/C

Shipping
Ships **assembled, FOB High Point, NC 27263, freight prepaid.** Freight class 250.

Specifications and prices are subject to change without prior notice.

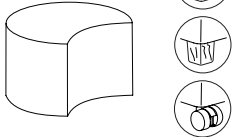
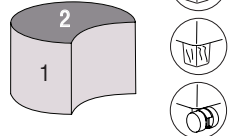

Features	MODEL NUMBER						Approx. Packaged Weight	Delivered Pricing	Moisture Barrier add to list price	
	Basic Model	Non-Contrast or Fabric Contrast 1	Fabric Contrast 2	Wood Feet Finish	Aluminum Feet Finish	Moisture Barrier				
concealed glides shown 	Concealed Glide, Non-contrast	MPCRE/CGL/NC	<input type="checkbox"/> <input type="checkbox"/> <input type="checkbox"/> <input type="checkbox"/>				<input type="checkbox"/> <input type="checkbox"/> <input type="checkbox"/>	68.00#	\$ 808	\$ 203
	Poly Feet, Non-contrast	MPCRE/PFT/NC	<input type="checkbox"/> <input type="checkbox"/> <input type="checkbox"/> <input type="checkbox"/>				<input type="checkbox"/> <input type="checkbox"/> <input type="checkbox"/>	68.00#	808	203
	Wood Feet, Non-contrast	MPCRE/WFT/NC	<input type="checkbox"/> <input type="checkbox"/> <input type="checkbox"/> <input type="checkbox"/>		<input type="checkbox"/> <input type="checkbox"/>		<input type="checkbox"/> <input type="checkbox"/> <input type="checkbox"/>	68.00#	938	203
	Casters, Non-contrast	MPCRE/CST/NC	<input type="checkbox"/> <input type="checkbox"/> <input type="checkbox"/> <input type="checkbox"/>				<input type="checkbox"/> <input type="checkbox"/> <input type="checkbox"/>	68.00#	808	203
	Aluminum Feet, Non-Contrast	MPCRE/AFT/NC	<input type="checkbox"/> <input type="checkbox"/> <input type="checkbox"/> <input type="checkbox"/>			<input type="checkbox"/> <input type="checkbox"/>	<input type="checkbox"/> <input type="checkbox"/> <input type="checkbox"/>	68.00#	946	203
MCRE 26" Crescent - Non-contrast • Non-contrast C.O.M = 2 yds • Ganging (specify kit separately) • Dia=26" H=18"										
concealed glides shown 	Concealed Glide, Contrast	MPCRE/CGL/FC	<input type="checkbox"/> <input type="checkbox"/> <input type="checkbox"/> <input type="checkbox"/>	<input type="checkbox"/> <input type="checkbox"/> <input type="checkbox"/> <input type="checkbox"/>			<input type="checkbox"/> <input type="checkbox"/> <input type="checkbox"/>	68.00#	\$ 840	\$ 203
	Poly Feet, Contrast	MPCRE/PFT/FC	<input type="checkbox"/> <input type="checkbox"/> <input type="checkbox"/> <input type="checkbox"/>	<input type="checkbox"/> <input type="checkbox"/> <input type="checkbox"/> <input type="checkbox"/>			<input type="checkbox"/> <input type="checkbox"/> <input type="checkbox"/>	68.00#	840	203
	Wood Feet, Contrast	MPCRE/WFT/FC	<input type="checkbox"/> <input type="checkbox"/> <input type="checkbox"/> <input type="checkbox"/>	<input type="checkbox"/> <input type="checkbox"/> <input type="checkbox"/> <input type="checkbox"/>	<input type="checkbox"/> <input type="checkbox"/>		<input type="checkbox"/> <input type="checkbox"/> <input type="checkbox"/>	68.00#	971	203
	Casters, Contrast	MPCRE/CST/FC	<input type="checkbox"/> <input type="checkbox"/> <input type="checkbox"/> <input type="checkbox"/>	<input type="checkbox"/> <input type="checkbox"/> <input type="checkbox"/> <input type="checkbox"/>			<input type="checkbox"/> <input type="checkbox"/> <input type="checkbox"/>	68.00#	840	203
	Aluminum Feet, Contrast	MPCRE/AFT/FC	<input type="checkbox"/> <input type="checkbox"/> <input type="checkbox"/> <input type="checkbox"/>	<input type="checkbox"/> <input type="checkbox"/> <input type="checkbox"/> <input type="checkbox"/>		<input type="checkbox"/> <input type="checkbox"/>	<input type="checkbox"/> <input type="checkbox"/> <input type="checkbox"/>	68.00#	980	203
MCRE 26" Crescent - Contrast • 1 = Base (Fabric Contrast 1) C.O.M. = 1.75 yd • 2 = Seat (Fabric Contrast 2) C.O.M. = .75 yd • Ganging (specify kit separately) • Dia=26" H=18"										
A B C D E F										

HOW TO ORDER

Indicate the following information on order form:

- Quantity of each item.
- Model number, including options. See "How To Build a Model Number".
- Any special service required.

Note:

- The indicates that a choice is required.
- The absence of the indicates that no choice is required.
- Alpha-numeric characters in place of indicate that no other alternatives are available.

HOW TO BUILD A MODEL NUMBER

See pricing column for moisture barrier upcharge.

A Select basic model.

B Select non-contrast or fabric contrast 1. Refer to ki.com/fabrics.

- For yardage pricing, see Fabric Yardage Pricing page

C Select fabric contrast 2. Refer to ki.com/fabrics.

- For yardage pricing, see Fabric Yardage Pricing page

D Select wood feet finish. Refer to the **Product Color Options** page in this price list.

E Select brushed aluminum feet finish. Refer to the **Product Color Options** page in this price list.

F Select moisture barrier.

MB - Moisture barrier

NMB - No moisture barrier

SPECIAL SERVICES

Special Carton Marking

With specially marked information N/C

Shipping

Ships **assembled, FOB High Point, NC 27263, freight prepaid.** Freight class 250.

Specifications and prices are subject to change without prior notice.

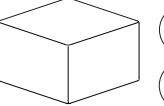
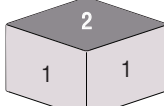

Features	MODEL NUMBER						Approx. Packaged Weight	Delivered Pricing	Moisture Barrier add to list price	
	Basic Model	Non-Contrast or Fabric Contrast 1	Fabric Contrast 2	Wood Feet Finish	Aluminum Feet Finish	Moisture Barrier				
concealed glides shown 	Concealed Glide, Non-contrast	MPSQR/CGL/NC	<input type="checkbox"/> <input type="checkbox"/> <input type="checkbox"/> <input type="checkbox"/>				<input type="checkbox"/> <input type="checkbox"/>	39.00#	\$ 892	\$ 232
	Poly Feet, Non-contrast	MPSQR/PFT/NC	<input type="checkbox"/> <input type="checkbox"/> <input type="checkbox"/> <input type="checkbox"/>				<input type="checkbox"/> <input type="checkbox"/>	39.00#	892	232
	Wood Feet, Non-contrast	MPSQR/WFT/NC	<input type="checkbox"/> <input type="checkbox"/> <input type="checkbox"/> <input type="checkbox"/>		<input type="checkbox"/> <input type="checkbox"/>		<input type="checkbox"/> <input type="checkbox"/>	39.00#	1020	232
	Casters, Non-contrast	MPSQR/CST/NC	<input type="checkbox"/> <input type="checkbox"/> <input type="checkbox"/> <input type="checkbox"/>				<input type="checkbox"/> <input type="checkbox"/>	39.00#	892	232
	Aluminum Feet, Non-contrast	MPSQR/AFT/NC	<input type="checkbox"/> <input type="checkbox"/> <input type="checkbox"/> <input type="checkbox"/>			<input type="checkbox"/> <input type="checkbox"/>	<input type="checkbox"/> <input type="checkbox"/>	39.00#	1030	232
	MSQR									
26" Square - Non-contrast • Non-contrast C.O.M = 3.5 yds • Ganging (specify kit separately) • W=26" D=26" H=18"										
concealed glides shown 	Concealed Glide, Contrast	MPSQR/CGL/FC	<input type="checkbox"/> <input type="checkbox"/> <input type="checkbox"/> <input type="checkbox"/>	<input type="checkbox"/> <input type="checkbox"/> <input type="checkbox"/> <input type="checkbox"/>			<input type="checkbox"/> <input type="checkbox"/>	39.00#	\$ 925	\$ 232
	Poly Feet, Contrast	MPSQR/PFT/FC	<input type="checkbox"/> <input type="checkbox"/> <input type="checkbox"/> <input type="checkbox"/>	<input type="checkbox"/> <input type="checkbox"/> <input type="checkbox"/> <input type="checkbox"/>			<input type="checkbox"/> <input type="checkbox"/>	39.00#	925	232
	Wood Feet, Contrast	MPSQR/WFT/FC	<input type="checkbox"/> <input type="checkbox"/> <input type="checkbox"/> <input type="checkbox"/>	<input type="checkbox"/> <input type="checkbox"/> <input type="checkbox"/> <input type="checkbox"/>	<input type="checkbox"/> <input type="checkbox"/>		<input type="checkbox"/> <input type="checkbox"/>	39.00#	1054	232
	Casters, Contrast	MPSQR/CST/FC	<input type="checkbox"/> <input type="checkbox"/> <input type="checkbox"/> <input type="checkbox"/>	<input type="checkbox"/> <input type="checkbox"/> <input type="checkbox"/> <input type="checkbox"/>			<input type="checkbox"/> <input type="checkbox"/>	39.00#	925	232
	Aluminum Feet, Contrast	MPSQR/AFT/FC	<input type="checkbox"/> <input type="checkbox"/> <input type="checkbox"/> <input type="checkbox"/>	<input type="checkbox"/> <input type="checkbox"/> <input type="checkbox"/> <input type="checkbox"/>		<input type="checkbox"/> <input type="checkbox"/>	<input type="checkbox"/> <input type="checkbox"/>	39.00#	1063	232
	MSQR									
26" Square - Contrast • 1 = Base (Fabric Contrast 1) C.O.M. = 2.5 yd • 2 = Seat (Fabric Contrast 2) C.O.M. = 1 yd • Ganging (specify kit separately) • W=26" D=26" H=18"										
A B C D E F										

HOW TO ORDER

Indicate the following information on order form:

- Quantity of each item.
- Model number, including options. See "How To Build a Model Number".
- Any special service required.

Note:

- The indicates that a choice is required.
- The absence of the indicates that no choice is required.
- Alpha-numeric characters in place of indicate that no other alternatives are available.

HOW TO BUILD A MODEL NUMBER

See pricing column for moisture barrier upcharge.

A Select basic model.

B Select non-contrast or fabric contrast 1. Refer to ki.com/fabrics.
 • For yardage pricing, see Fabric Yardage Pricing page

C Select fabric contrast 2. Refer to ki.com/fabrics.
 • For yardage pricing, see Fabric Yardage Pricing page

D Select wood feet finish. Refer to the **Product Color Options** page in this price list.

E Select brushed aluminum feet finish. Refer to the **Product Color Options** page in this price list.

F Select moisture barrier.
MB - Moisture barrier
NMB - No moisture barrier

SPECIAL SERVICES

Special Carton Marking
 With specially marked information N/C

Shipping
 Ships assembled, FOB High Point, NC 27263, freight prepaid. Freight class 250.

Specifications and prices are subject to change without prior notice.



Features	MODEL NUMBER						Approx. Packaged Weight	Delivered Pricing	Moisture Barrier add to list price	
	Basic Model	Non-Contrast or Fabric Contrast 1	Fabric Contrast 2	Wood Feet Finish	Aluminum Feet Finish	Moisture Barrier				
concealed glides shown M26H 26" Hexagon - Non-contrast • Non-contrast C.O.M = 2.25 yds • Ganging (specify kit separately) Overall Dimensions: • W=30" D=26" H=18"	Concealed Glides, Non-contrast	MP26H/CGL/NC	<input type="checkbox"/> <input type="checkbox"/> <input type="checkbox"/> <input type="checkbox"/>				<input type="checkbox"/> <input type="checkbox"/> <input type="checkbox"/>	41.00#	\$ 934	\$ 245
	Poly Feet, Non-contrast	MP26H/PFT/NC	<input type="checkbox"/> <input type="checkbox"/> <input type="checkbox"/> <input type="checkbox"/>				<input type="checkbox"/> <input type="checkbox"/> <input type="checkbox"/>	41.00#	990	245
	Wood Feet, Non-contrast	MP26H/WFT/NC	<input type="checkbox"/> <input type="checkbox"/> <input type="checkbox"/> <input type="checkbox"/>		<input type="checkbox"/> <input type="checkbox"/>		<input type="checkbox"/> <input type="checkbox"/> <input type="checkbox"/>	41.00#	1122	245
	Casters, Non-contrast	MP26H/CST/NC	<input type="checkbox"/> <input type="checkbox"/> <input type="checkbox"/> <input type="checkbox"/>				<input type="checkbox"/> <input type="checkbox"/> <input type="checkbox"/>	41.00#	990	245
	Aluminum Feet, Non-contrast	MP26H/AFT/NC	<input type="checkbox"/> <input type="checkbox"/> <input type="checkbox"/> <input type="checkbox"/>			<input type="checkbox"/> <input type="checkbox"/>	<input type="checkbox"/> <input type="checkbox"/> <input type="checkbox"/>	41.00#	1128	245
concealed glides shown M26H 26" Hexagon - Contrast • 1 = Base (Fabric Contrast 1) C.O.M. = 1.5 yd • 2 = Seat (Fabric Contrast 2) C.O.M. = 1.25 yd • Ganging (specify kit separately) Overall Dimensions: • W=30" D=26" H=18"	Concealed Glides, Contrast	MP26H/CGL/FC	<input type="checkbox"/> <input type="checkbox"/> <input type="checkbox"/> <input type="checkbox"/>	<input type="checkbox"/> <input type="checkbox"/> <input type="checkbox"/> <input type="checkbox"/>			<input type="checkbox"/> <input type="checkbox"/> <input type="checkbox"/>	41.00#	\$ 964	\$ 245
	Poly Feet, Non-contrast	MP26H/PFT/FC	<input type="checkbox"/> <input type="checkbox"/> <input type="checkbox"/> <input type="checkbox"/>	<input type="checkbox"/> <input type="checkbox"/> <input type="checkbox"/> <input type="checkbox"/>			<input type="checkbox"/> <input type="checkbox"/> <input type="checkbox"/>	41.00#	1020	245
	Wood Feet, Contrast	MP26H/WFT/FC	<input type="checkbox"/> <input type="checkbox"/> <input type="checkbox"/> <input type="checkbox"/>	<input type="checkbox"/> <input type="checkbox"/> <input type="checkbox"/> <input type="checkbox"/>	<input type="checkbox"/> <input type="checkbox"/>		<input type="checkbox"/> <input type="checkbox"/> <input type="checkbox"/>	41.00#	1153	245
	Casters, Contrast	MP26H/CST/FC	<input type="checkbox"/> <input type="checkbox"/> <input type="checkbox"/> <input type="checkbox"/>	<input type="checkbox"/> <input type="checkbox"/> <input type="checkbox"/> <input type="checkbox"/>			<input type="checkbox"/> <input type="checkbox"/> <input type="checkbox"/>	41.00#	1020	245
	Aluminum Feet, Contrast	MP26H/AFT/FC	<input type="checkbox"/> <input type="checkbox"/> <input type="checkbox"/> <input type="checkbox"/>	<input type="checkbox"/> <input type="checkbox"/> <input type="checkbox"/> <input type="checkbox"/>		<input type="checkbox"/> <input type="checkbox"/>	<input type="checkbox"/> <input type="checkbox"/> <input type="checkbox"/>	41.00#	1158	245
			A	B	C	D	E	F		

HOW TO ORDER

Indicate the following information on order form:

- Quantity of each item.
- Model number, including options. See "How To Build a Model Number".
- Any special service required.

Note:

- The indicates that a choice is required.
- The absence of the indicates that no choice is required.
- Alpha-numeric characters in place of indicate that no other alternatives are available.

HOW TO BUILD A MODEL NUMBER

See pricing column for moisture barrier upcharge.

A Select basic model.

B Select non-contrast or fabric contrast 1. Refer to ki.com/fabrics.
 • For yardage pricing, see Fabric Yardage Pricing page

C Select fabric contrast 2. Refer to ki.com/fabrics.
 • For yardage pricing, see Fabric Yardage Pricing page

D Select wood feet finish. Refer to the **Product Color Options** page in this price list.

E Select brushed aluminum feet finish. Refer to the **Product Color Options** page in this price list.

F Select moisture barrier.
MB - Moisture barrier
NMB - No moisture barrier



SPECIAL SERVICES

Special Carton Marking
 With specially marked information N/C

Shipping
 Ships assembled, FOB High Point, NC 27263, freight prepaid. Freight class 250.

Specifications and prices are subject to change without prior notice.

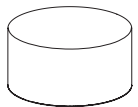

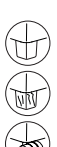
Features	MODEL NUMBER						Approx. Packaged Weight	Delivered Pricing	Moisture Barrier add to list price	
	Basic Model	Non-Contrast or Fabric Contrast 1	Fabric Contrast 2	Wood Feet Finish	Aluminum Feet Finish	Moisture Barrier				
concealed glides shown  	Concealed Glide, Non-contrast	MP36R/CGL/NC	<input type="checkbox"/> <input type="checkbox"/> <input type="checkbox"/> <input type="checkbox"/>				<input type="checkbox"/> <input type="checkbox"/> <input type="checkbox"/>	65.00#	\$ 1250	\$ 317
	Poly Feet, Non-contrast	MP36R/PFT/NC	<input type="checkbox"/> <input type="checkbox"/> <input type="checkbox"/> <input type="checkbox"/>				<input type="checkbox"/> <input type="checkbox"/> <input type="checkbox"/>	65.00#	1306	317
	Wood Feet, Non-contrast	MP36R/WFT/NC	<input type="checkbox"/> <input type="checkbox"/> <input type="checkbox"/> <input type="checkbox"/>		<input type="checkbox"/> <input type="checkbox"/>		<input type="checkbox"/> <input type="checkbox"/> <input type="checkbox"/>	65.00#	1439	317
	Casters, Non-contrast	MP36R/CST/NC	<input type="checkbox"/> <input type="checkbox"/> <input type="checkbox"/> <input type="checkbox"/>				<input type="checkbox"/> <input type="checkbox"/> <input type="checkbox"/>	65.00#	1306	317
	Aluminum Feet, Non-contrast	MP36R/AFT/NC	<input type="checkbox"/> <input type="checkbox"/> <input type="checkbox"/> <input type="checkbox"/>			<input type="checkbox"/> <input type="checkbox"/>	<input type="checkbox"/> <input type="checkbox"/> <input type="checkbox"/>	65.00#	1444	317
M36R 36" Round - Non-contrast • Non-contrast C.O.M = 3.75 yds • Ganging (specify kit seperately) • Dia=36" H=18"										
concealed glides shown  	Concealed Glide, Contrast	MP36R/CGL/FC	<input type="checkbox"/> <input type="checkbox"/> <input type="checkbox"/> <input type="checkbox"/>	<input type="checkbox"/> <input type="checkbox"/> <input type="checkbox"/> <input type="checkbox"/>			<input type="checkbox"/> <input type="checkbox"/> <input type="checkbox"/>	65.00#	\$ 1281	\$ 317
	Poly Feet, Contrast	MP36R/PFT/FC	<input type="checkbox"/> <input type="checkbox"/> <input type="checkbox"/> <input type="checkbox"/>	<input type="checkbox"/> <input type="checkbox"/> <input type="checkbox"/> <input type="checkbox"/>			<input type="checkbox"/> <input type="checkbox"/> <input type="checkbox"/>	65.00#	1337	317
	Wood Feet, Contrast	MP36R/WFT/FC	<input type="checkbox"/> <input type="checkbox"/> <input type="checkbox"/> <input type="checkbox"/>	<input type="checkbox"/> <input type="checkbox"/> <input type="checkbox"/> <input type="checkbox"/>	<input type="checkbox"/> <input type="checkbox"/>		<input type="checkbox"/> <input type="checkbox"/> <input type="checkbox"/>	65.00#	1469	317
	Casters, Contrast	MP36R/CST/FC	<input type="checkbox"/> <input type="checkbox"/> <input type="checkbox"/> <input type="checkbox"/>	<input type="checkbox"/> <input type="checkbox"/> <input type="checkbox"/> <input type="checkbox"/>			<input type="checkbox"/> <input type="checkbox"/> <input type="checkbox"/>	65.00#	1337	317
	Aluminum Feet, Contrast	MP36R/AFT/FC	<input type="checkbox"/> <input type="checkbox"/> <input type="checkbox"/> <input type="checkbox"/>	<input type="checkbox"/> <input type="checkbox"/> <input type="checkbox"/> <input type="checkbox"/>		<input type="checkbox"/> <input type="checkbox"/>	<input type="checkbox"/> <input type="checkbox"/> <input type="checkbox"/>	65.00#	1474	317
M36R 36" Round - Contrast • 1 = Base (Fabric Contrast 1) C.O.M. = 2.75 yd • 2 = Seat (Fabric Contrast 2) C.O.M. = 1.25 yd • Ganging (specify kit seperately) • Dia=36" H=18"										
A B C D E F										

HOW TO ORDER

Indicate the following information on order form:

- Quantity of each item.
- Model number, including options. See "How To Build a Model Number".
- Any special service required.

Note:

- The indicates that a choice is required.
- The absence of the indicates that no choice is required.
- Alpha-numeric characters in place of indicate that no other alternatives are available.

HOW TO BUILD A MODEL NUMBER

See pricing column for moisture barrier upcharge.

A Select basic model.

B Select non-contrast or fabric contrast 1. Refer to ki.com/fabrics.
 • For yardage pricing, see Fabric Yardage Pricing page

C Select fabric contrast 2. Refer to ki.com/fabrics.
 • For yardage pricing, see Fabric Yardage Pricing page

D Select wood feet finish. Refer to the **Product Color Options** page in this price list.

E Select brushed aluminum feet finish. Refer to the **Product Color Options** page in this price list.

F Select moisture barrier.
MB - Moisture barrier
NMB - No moisture barrier

SPECIAL SERVICES

Special Carton Marking
 With specially marked information N/C

Shipping
 Ships assembled, FOB High Point, NC 27263, freight prepaid. Freight class 250.

Specifications and prices are subject to change without prior notice.

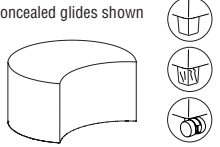
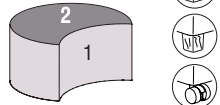

Features	MODEL NUMBER						Approx. Packaged Weight	Delivered Pricing	Moisture Barrier add to list price
	Basic Model	Non-Contrast or Fabric Contrast 1	Fabric Contrast 2	Wood Feet Finish	Alum-inum Feet Finish	Moisture Barrier			
concealed glides shown 	Concealed Glide, Non-contrast	MP36CRE/CGL/NC	<input type="checkbox"/> <input type="checkbox"/> <input type="checkbox"/> <input type="checkbox"/>				<input type="checkbox"/> <input type="checkbox"/> <input type="checkbox"/>	\$ 1255	\$ 317
	Poly Feet, Non-contrast	MP36CRE/PFT/NC	<input type="checkbox"/> <input type="checkbox"/> <input type="checkbox"/> <input type="checkbox"/>				<input type="checkbox"/> <input type="checkbox"/> <input type="checkbox"/>	1311	317
	Wood Feet, Non-contrast	MP36CRE/WFT/NC	<input type="checkbox"/> <input type="checkbox"/> <input type="checkbox"/> <input type="checkbox"/>		<input type="checkbox"/> <input type="checkbox"/>		<input type="checkbox"/> <input type="checkbox"/> <input type="checkbox"/>	1444	317
	Casters, Non-contrast	MP36CRE/CST/NC	<input type="checkbox"/> <input type="checkbox"/> <input type="checkbox"/> <input type="checkbox"/>				<input type="checkbox"/> <input type="checkbox"/> <input type="checkbox"/>	1311	317
	Aluminum Feet, Non-Contrast	MP36CRE/AFT/NC	<input type="checkbox"/> <input type="checkbox"/> <input type="checkbox"/> <input type="checkbox"/>			<input type="checkbox"/> <input type="checkbox"/>	<input type="checkbox"/> <input type="checkbox"/> <input type="checkbox"/>	1449	317
M36C 36" Crescent - Non-contrast • Non-contrast C.O.M = 3 yds • Ganging (specify kit separately) • Dia=36" H=18"									
concealed glides shown 	Concealed Glide, Contrast	MP36CRE/CGL/FC	<input type="checkbox"/> <input type="checkbox"/> <input type="checkbox"/> <input type="checkbox"/>	<input type="checkbox"/> <input type="checkbox"/> <input type="checkbox"/> <input type="checkbox"/>			<input type="checkbox"/> <input type="checkbox"/> <input type="checkbox"/>	\$ 1286	\$ 317
	Poly Feet, Contrast	MP36CRE/PFT/FC	<input type="checkbox"/> <input type="checkbox"/> <input type="checkbox"/> <input type="checkbox"/>	<input type="checkbox"/> <input type="checkbox"/> <input type="checkbox"/> <input type="checkbox"/>			<input type="checkbox"/> <input type="checkbox"/> <input type="checkbox"/>	1342	317
	Wood Feet, Contrast	MP36CRE/WFT/FC	<input type="checkbox"/> <input type="checkbox"/> <input type="checkbox"/> <input type="checkbox"/>	<input type="checkbox"/> <input type="checkbox"/> <input type="checkbox"/> <input type="checkbox"/>	<input type="checkbox"/> <input type="checkbox"/>		<input type="checkbox"/> <input type="checkbox"/> <input type="checkbox"/>	1474	317
	Casters, Contrast	MP36CRE/CST/FC	<input type="checkbox"/> <input type="checkbox"/> <input type="checkbox"/> <input type="checkbox"/>	<input type="checkbox"/> <input type="checkbox"/> <input type="checkbox"/> <input type="checkbox"/>			<input type="checkbox"/> <input type="checkbox"/> <input type="checkbox"/>	1342	317
	Aluminum Feet, Contrast	MP36CRE/AFT/FC	<input type="checkbox"/> <input type="checkbox"/> <input type="checkbox"/> <input type="checkbox"/>	<input type="checkbox"/> <input type="checkbox"/> <input type="checkbox"/> <input type="checkbox"/>		<input type="checkbox"/> <input type="checkbox"/>	<input type="checkbox"/> <input type="checkbox"/> <input type="checkbox"/>	1479	317
M36C 36" Crescent - Contrast • 1 = Base (Fabric Contrast 1) C.O.M. = 2 yd • 2 = Seat (Fabric Contrast 2) C.O.M. = 1.25 yd • Ganging (specify kit separately) • Dia=36" H=18"									
A B C D E F									

HOW TO ORDER

Indicate the following information on order form:

- Quantity of each item.
- Model number, including options. See "How To Build a Model Number".
- Any special service required.

Note:

- The indicates that a choice is required.
- The absence of the indicates that no choice is required.
- Alpha-numeric characters in place of indicate that no other alternatives are available.

HOW TO BUILD A MODEL NUMBER

See pricing column for moisture barrier upcharge.

A Select basic model.

B Select non-contrast or fabric contrast 1. Refer to ki.com/fabrics.
 • For yardage pricing, see Fabric Yardage Pricing page

C Select fabric contrast 2. Refer to ki.com/fabrics.
 • For yardage pricing, see Fabric Yardage Pricing page

D Select wood feet finish. Refer to the **Product Color Options** page in this price list.

E Select brushed aluminum feet finish. Refer to the **Product Color Options** page in this price list.

F Select moisture barrier.
MB - Moisture barrier
NMB - No moisture barrier

SPECIAL SERVICES

Special Carton Marking
 With specially marked information N/C

Shipping
 Ships assembled, FOB High Point, NC 27263, freight prepaid. Freight class 250.

Specifications and prices are subject to change without prior notice.

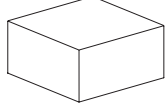
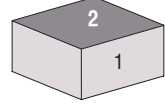

Features	MODEL NUMBER						Approx. Packaged Weight	Delivered Pricing	Moisture Barrier add to list price	
	Basic Model	Non-Contrast or Fabric Contrast 1	Fabric Contrast 2	Wood Feet Finish	Aluminum Feet Finish	Moisture Barrier				
concealed glides shown 	Concealed Glide, Non-contrast	MP36SQR/CGL/NC	<input type="checkbox"/> <input type="checkbox"/> <input type="checkbox"/> <input type="checkbox"/>				<input type="checkbox"/> <input type="checkbox"/>	70.00#	\$ 1275	\$ 317
	Poly Feet, Non-contrast	MP36SQR/PFT/NC	<input type="checkbox"/> <input type="checkbox"/> <input type="checkbox"/> <input type="checkbox"/>				<input type="checkbox"/> <input type="checkbox"/>	70.00#	1332	317
	Wood Feet, Non-contrast	MP36SQR/WFT/NC	<input type="checkbox"/> <input type="checkbox"/> <input type="checkbox"/> <input type="checkbox"/>		<input type="checkbox"/> <input type="checkbox"/> <input type="checkbox"/>		<input type="checkbox"/> <input type="checkbox"/>	70.00#	1464	317
	Casters, Non-contrast	MP36SQR/CST/NC	<input type="checkbox"/> <input type="checkbox"/> <input type="checkbox"/> <input type="checkbox"/>				<input type="checkbox"/> <input type="checkbox"/>	70.00#	1332	317
	Aluminum Feet, Non-contrast	MP36SQR/AFT/NC	<input type="checkbox"/> <input type="checkbox"/> <input type="checkbox"/> <input type="checkbox"/>			<input type="checkbox"/> <input type="checkbox"/>	<input type="checkbox"/> <input type="checkbox"/>	70.00#	1469	317
M36S 36" Square - Non-contrast • Non-contrast C.O.M = 3.75 yds • Ganging (specify kit separately) • W=36" D=36" H=18"										
concealed glides shown 	Concealed Glide, Contrast	MP36SQR/CGL/FC	<input type="checkbox"/> <input type="checkbox"/> <input type="checkbox"/> <input type="checkbox"/>	<input type="checkbox"/> <input type="checkbox"/> <input type="checkbox"/> <input type="checkbox"/>			<input type="checkbox"/> <input type="checkbox"/>	70.00#	\$ 1306	\$ 317
	Poly Feet, Contrast	MP36SQR/PFT/FC	<input type="checkbox"/> <input type="checkbox"/> <input type="checkbox"/> <input type="checkbox"/>	<input type="checkbox"/> <input type="checkbox"/> <input type="checkbox"/> <input type="checkbox"/>			<input type="checkbox"/> <input type="checkbox"/>	70.00#	1362	317
	Wood Feet, Contrast	MP36SQR/WFT/FC	<input type="checkbox"/> <input type="checkbox"/> <input type="checkbox"/> <input type="checkbox"/>	<input type="checkbox"/> <input type="checkbox"/> <input type="checkbox"/> <input type="checkbox"/>	<input type="checkbox"/> <input type="checkbox"/> <input type="checkbox"/>		<input type="checkbox"/> <input type="checkbox"/>	70.00#	1495	317
	Casters, Contrast	MP36SQR/CST/FC	<input type="checkbox"/> <input type="checkbox"/> <input type="checkbox"/> <input type="checkbox"/>	<input type="checkbox"/> <input type="checkbox"/> <input type="checkbox"/> <input type="checkbox"/>			<input type="checkbox"/> <input type="checkbox"/>	70.00#	1362	317
	Aluminum Feet, Contrast	MP36SQR/AFT/FC	<input type="checkbox"/> <input type="checkbox"/> <input type="checkbox"/> <input type="checkbox"/>	<input type="checkbox"/> <input type="checkbox"/> <input type="checkbox"/> <input type="checkbox"/>		<input type="checkbox"/> <input type="checkbox"/>	<input type="checkbox"/> <input type="checkbox"/>	70.00#	1500	317
M36S 36" Square - Contrast • 1 = Base (Fabric Contrast 1) C.O.M. = 2.75 yd • 2 = Seat (Fabric Contrast 2) C.O.M. = 1.25 yd • Ganging (specify kit separately) • W=36" D=36" H=18"										
A B C D E F										

HOW TO ORDER

- Indicate the following information on order form:
- Quantity of each item.
 - Model number, including options. See "How To Build a Model Number".
 - Any special service required.

Note:

- The indicates that a choice is required.
- The absence of the indicates that no choice is required.
- Alpha-numeric characters in place of indicate that no other alternatives are available.

HOW TO BUILD A MODEL NUMBER

See pricing column for moisture barrier upcharge.

- A** Select basic model.
- B** Select non-contrast or fabric contrast 1. Refer to ki.com/fabrics.
• For yardage pricing, see Fabric Yardage Pricing page
- C** Select fabric contrast 2. Refer to ki.com/fabrics.
• For yardage pricing, see Fabric Yardage Pricing page
- D** Select wood feet finish. Refer to the **Product Color Options** page in this price list.
- E** Select brushed aluminum feet finish. Refer to the **Product Color Options** page in this price list.
- F** Select moisture barrier.

MB	- Moisture barrier
NMB	- No moisture barrier

SPECIAL SERVICES

Special Carton Marking

With specially marked information N/C

Shipping

Ships assembled, FOB High Point, NC 27263, freight prepaid. Freight class 250.

Specifications and prices are subject to change without prior notice.



Features	MODEL NUMBER						Approx. Packaged Weight	Delivered Pricing	Moisture Barrier add to list price	
	Basic Model	Non-Contrast or Fabric Contrast 1	Fabric Contrast 2	Wood Feet Finish	Aluminum Feet Finish	Moisture Barrier				
concealed glides shown 	Concealed Glide, Non-contrast	MP48R/CGL/NC	<input type="checkbox"/> <input type="checkbox"/> <input type="checkbox"/> <input type="checkbox"/>				<input type="checkbox"/> <input type="checkbox"/> <input type="checkbox"/>	75.00#	\$ 1541	\$ 378
	Poly Feet, Non-contrast	MP48R/PFT/NC	<input type="checkbox"/> <input type="checkbox"/> <input type="checkbox"/> <input type="checkbox"/>				<input type="checkbox"/> <input type="checkbox"/> <input type="checkbox"/>	75.00#	1612	378
	Wood Feet, Non-contrast	MP48R/WFT/NC	<input type="checkbox"/> <input type="checkbox"/> <input type="checkbox"/> <input type="checkbox"/>		<input type="checkbox"/> <input type="checkbox"/>		<input type="checkbox"/> <input type="checkbox"/> <input type="checkbox"/>	75.00#	1745	378
	Casters, Non-contrast	MP48R/CST/NC	<input type="checkbox"/> <input type="checkbox"/> <input type="checkbox"/> <input type="checkbox"/>				<input type="checkbox"/> <input type="checkbox"/> <input type="checkbox"/>	75.00#	1612	378
	Aluminum Feet, Non-contrast	MP48R/AFT/NC	<input type="checkbox"/> <input type="checkbox"/> <input type="checkbox"/> <input type="checkbox"/>			<input type="checkbox"/> <input type="checkbox"/>	<input type="checkbox"/> <input type="checkbox"/> <input type="checkbox"/>	75.00#	1750	378
M48R 48" Round - Non-contrast • Non-contrast C.O.M = 3.5 yds • Ganging (specify kit seperately) • Dia=48" H=18"										
concealed glides shown 	Concealed Glide, Contrast	MP48R/CGL/FC	<input type="checkbox"/> <input type="checkbox"/> <input type="checkbox"/> <input type="checkbox"/>	<input type="checkbox"/> <input type="checkbox"/> <input type="checkbox"/> <input type="checkbox"/>			<input type="checkbox"/> <input type="checkbox"/> <input type="checkbox"/>	75.00#	\$ 1571	\$ 378
	Poly Feet, Contrast	MP48R/PFT/FC	<input type="checkbox"/> <input type="checkbox"/> <input type="checkbox"/> <input type="checkbox"/>	<input type="checkbox"/> <input type="checkbox"/> <input type="checkbox"/> <input type="checkbox"/>			<input type="checkbox"/> <input type="checkbox"/> <input type="checkbox"/>	75.00#	1643	378
	Wood Feet, Contrast	MP48R/WFT/FC	<input type="checkbox"/> <input type="checkbox"/> <input type="checkbox"/> <input type="checkbox"/>	<input type="checkbox"/> <input type="checkbox"/> <input type="checkbox"/> <input type="checkbox"/>	<input type="checkbox"/> <input type="checkbox"/>		<input type="checkbox"/> <input type="checkbox"/> <input type="checkbox"/>	75.00#	1775	378
	Casters, Contrast	MP48R/CST/FC	<input type="checkbox"/> <input type="checkbox"/> <input type="checkbox"/> <input type="checkbox"/>	<input type="checkbox"/> <input type="checkbox"/> <input type="checkbox"/> <input type="checkbox"/>			<input type="checkbox"/> <input type="checkbox"/> <input type="checkbox"/>	75.00#	1643	378
	Aluminum Feet, Contrast	MP48R/AFT/FC	<input type="checkbox"/> <input type="checkbox"/> <input type="checkbox"/> <input type="checkbox"/>	<input type="checkbox"/> <input type="checkbox"/> <input type="checkbox"/> <input type="checkbox"/>		<input type="checkbox"/> <input type="checkbox"/>	<input type="checkbox"/> <input type="checkbox"/> <input type="checkbox"/>	75.00#	1780	378
M48R 48" Round - Contrast • 1 = Base (Fabric Contrast 1) C.O.M. = 2 yd • 2 = Seat (Fabric Contrast 2) C.O.M. = 1.75 yd • Ganging (specify kit seperately) • Dia=48" H=18"										
A B C D E F										

HOW TO ORDER

- Indicate the following information on order form:
- Quantity of each item.
 - Model number, including options. See "How To Build a Model Number".
 - Any special service required.

Note: • The indicates that a choice is required.
 • The absence of the indicates that no choice is required.
 • Alpha-numeric characters in place of indicate that no other alternatives are available.

HOW TO BUILD A MODEL NUMBER

See pricing column for moisture barrier upcharge.

- A** Select basic model.
- B** Select non-contrast or fabric contrast 1. Refer to ki.com/fabrics.
 • For yardage pricing, see Fabric Yardage Pricing page
- C** Select fabric contrast 2. Refer to ki.com/fabrics.
 • For yardage pricing, see Fabric Yardage Pricing page
- D** Select wood feet finish. Refer to the **Product Color Options** page in this price list.
- E** Select brushed aluminum feet finish. Refer to the **Product Color Options** page in this price list.
- F** Select moisture barrier.
MB - Moisture barrier
NMB - No moisture barrier

SPECIAL SERVICES

Special Carton Marking

With specially marked information N/C

Shipping

Ships **assembled, FOB High Point, NC 27263, freight prepaid.** Freight class 250.

Specifications and prices are subject to change without prior notice.

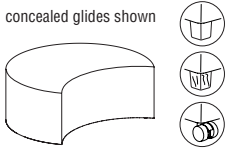
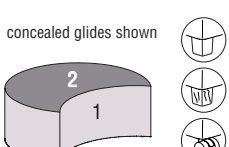

Features	MODEL NUMBER						Approx. Packaged Weight	Delivered Pricing	Moisture Barrier add to list price	
	Basic Model	Non-Contrast or Fabric Contrast 1	Fabric Contrast 2	Wood Feet Finish	Aluminum Feet Finish	Moisture Barrier				
concealed glides shown 	Concealed Glide, Non-contrast	MP48CRE/CGL/NC	<input type="checkbox"/> <input type="checkbox"/> <input type="checkbox"/> <input type="checkbox"/>				<input type="checkbox"/> <input type="checkbox"/>	65.00#	\$ 1546	\$ 378
	Poly Feet, Non-contrast	MP48CRE/PFT/NC	<input type="checkbox"/> <input type="checkbox"/> <input type="checkbox"/> <input type="checkbox"/>				<input type="checkbox"/> <input type="checkbox"/>	65.00#	1617	378
	Wood Feet, Non-contrast	MP48CRE/WFT/NC	<input type="checkbox"/> <input type="checkbox"/> <input type="checkbox"/> <input type="checkbox"/>		<input type="checkbox"/> <input type="checkbox"/>		<input type="checkbox"/> <input type="checkbox"/>	65.00#	1750	378
	Casters, Non-contrast	MP48CRE/CST/NC	<input type="checkbox"/> <input type="checkbox"/> <input type="checkbox"/> <input type="checkbox"/>				<input type="checkbox"/> <input type="checkbox"/>	65.00#	1617	378
	Aluminum Feet, Non-Contrast	MP48CRE/AFT/NC	<input type="checkbox"/> <input type="checkbox"/> <input type="checkbox"/> <input type="checkbox"/>			<input type="checkbox"/> <input type="checkbox"/>	<input type="checkbox"/> <input type="checkbox"/>	65.00#	1755	378
M48C 48" Crescent - Non-contrast • Non-contrast C.O.M = 3.75 yds • Ganging (specify kit separately) • Dia=48" H=18"										
concealed glides shown 	Concealed Glide, Contrast	MP48CRE/CGL/FC	<input type="checkbox"/> <input type="checkbox"/> <input type="checkbox"/> <input type="checkbox"/>	<input type="checkbox"/> <input type="checkbox"/> <input type="checkbox"/> <input type="checkbox"/>			<input type="checkbox"/> <input type="checkbox"/>	65.00#	\$ 1576	\$ 378
	Poly Feet, Contrast	MP48CRE/PFT/FC	<input type="checkbox"/> <input type="checkbox"/> <input type="checkbox"/> <input type="checkbox"/>	<input type="checkbox"/> <input type="checkbox"/> <input type="checkbox"/> <input type="checkbox"/>			<input type="checkbox"/> <input type="checkbox"/>	65.00#	1648	378
	Wood Feet, Contrast	MP48CRE/WFT/FC	<input type="checkbox"/> <input type="checkbox"/> <input type="checkbox"/> <input type="checkbox"/>	<input type="checkbox"/> <input type="checkbox"/> <input type="checkbox"/> <input type="checkbox"/>	<input type="checkbox"/> <input type="checkbox"/>		<input type="checkbox"/> <input type="checkbox"/>	65.00#	1780	378
	Casters, Contrast	MP48CRE/CST/FC	<input type="checkbox"/> <input type="checkbox"/> <input type="checkbox"/> <input type="checkbox"/>	<input type="checkbox"/> <input type="checkbox"/> <input type="checkbox"/> <input type="checkbox"/>			<input type="checkbox"/> <input type="checkbox"/>	65.00#	1648	378
	Aluminum Feet, Contrast	MP48CRE/AFT/FC	<input type="checkbox"/> <input type="checkbox"/> <input type="checkbox"/> <input type="checkbox"/>	<input type="checkbox"/> <input type="checkbox"/> <input type="checkbox"/> <input type="checkbox"/>		<input type="checkbox"/> <input type="checkbox"/>	<input type="checkbox"/> <input type="checkbox"/>	65.00#	1785	378
M48C 48" Crescent - Contrast • 1 = Base (Fabric Contrast 1) C.O.M. = 2.5 yd • 2 = Seat (Fabric Contrast 2) C.O.M. = 1.5 yd • Ganging (specify kit separately) • Dia=48" H=18"										
A B C D E F										

HOW TO ORDER

Indicate the following information on order form:
 1. Quantity of each item.
 2. Model number, including options. See "How To Build a Model Number".
 3. Any special service required.

Note: • The indicates that a choice is required.
 • The absence of the indicates that no choice is required.
 • Alpha-numeric characters in place of indicate that no other alternatives are available.

HOW TO BUILD A MODEL NUMBER

See pricing column for moisture barrier upcharge.

- A** Select basic model.
- B** Select non-contrast or fabric contrast 1. Refer to ki.com/fabrics.
 • For yardage pricing, see Fabric Yardage Pricing page
- C** Select fabric contrast 2. Refer to ki.com/fabrics.
 • For yardage pricing, see Fabric Yardage Pricing page
- D** Select wood feet finish. Refer to the **Product Color Options** page in this price list.
- E** Select brushed aluminum feet finish. Refer to the **Product Color Options** page in this price list.
- F** Select moisture barrier.
MB - Moisture barrier
NMB - No moisture barrier

SPECIAL SERVICES

Special Carton Marking
 With specially marked information N/C

Shipping
 Ships **assembled, FOB High Point, NC 27263, freight prepaid.** Freight class 250.

Specifications and prices are subject to change without prior notice.

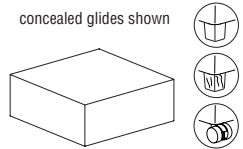
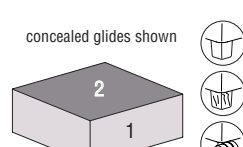

Features	MODEL NUMBER						Approx. Packaged Weight	Delivered Pricing	Moisture Barrier add to list price	
	Basic Model	Non-Contrast or Fabric Contrast 1	Fabric Contrast 2	Wood Feet Finish	Aluminum Feet Finish	Moisture Barrier				
concealed glides shown 	Concealed Glide, Non-contrast	MP48SQR/CGL/NC	<input type="checkbox"/> <input type="checkbox"/> <input type="checkbox"/> <input type="checkbox"/>				<input type="checkbox"/> <input type="checkbox"/>	100.00#	\$ 1571	\$ 378
	Poly Feet, Non-contrast	MP48SQR/PFT/NC	<input type="checkbox"/> <input type="checkbox"/> <input type="checkbox"/> <input type="checkbox"/>				<input type="checkbox"/> <input type="checkbox"/>	100.00#	1643	378
	Wood Feet, Non-contrast	MP48SQR/WFT/NC	<input type="checkbox"/> <input type="checkbox"/> <input type="checkbox"/> <input type="checkbox"/>		<input type="checkbox"/> <input type="checkbox"/>		<input type="checkbox"/> <input type="checkbox"/>	100.00#	1775	378
	Casters, Non-contrast	MP48SQR/CST/NC	<input type="checkbox"/> <input type="checkbox"/> <input type="checkbox"/> <input type="checkbox"/>				<input type="checkbox"/> <input type="checkbox"/>	100.00#	1643	378
	Aluminum Feet, Non-contrast	MP48SQR/AFT/NC	<input type="checkbox"/> <input type="checkbox"/> <input type="checkbox"/> <input type="checkbox"/>			<input type="checkbox"/> <input type="checkbox"/>	<input type="checkbox"/> <input type="checkbox"/>	100.00#	1780	378
M48S 48" Square - Non-contrast • Non-contrast C.O.M = 4 yds • Ganging (specify kit separately) • W=47.5" D=47.5" H=18"										
concealed glides shown 	Concealed Glide, Contrast	MP48SQR/CGL/FC	<input type="checkbox"/> <input type="checkbox"/> <input type="checkbox"/> <input type="checkbox"/>	<input type="checkbox"/> <input type="checkbox"/> <input type="checkbox"/> <input type="checkbox"/>			<input type="checkbox"/> <input type="checkbox"/>	100.00#	\$ 1602	\$ 378
	Poly Feet, Contrast	MP48SQR/PFT/FC	<input type="checkbox"/> <input type="checkbox"/> <input type="checkbox"/> <input type="checkbox"/>	<input type="checkbox"/> <input type="checkbox"/> <input type="checkbox"/> <input type="checkbox"/>			<input type="checkbox"/> <input type="checkbox"/>	100.00#	1673	378
	Wood Feet, Contrast	MP48SQR/WFT/FC	<input type="checkbox"/> <input type="checkbox"/> <input type="checkbox"/> <input type="checkbox"/>	<input type="checkbox"/> <input type="checkbox"/> <input type="checkbox"/> <input type="checkbox"/>	<input type="checkbox"/> <input type="checkbox"/>		<input type="checkbox"/> <input type="checkbox"/>	100.00#	1806	378
	Casters, Contrast	MP48SQR/CST/FC	<input type="checkbox"/> <input type="checkbox"/> <input type="checkbox"/> <input type="checkbox"/>	<input type="checkbox"/> <input type="checkbox"/> <input type="checkbox"/> <input type="checkbox"/>			<input type="checkbox"/> <input type="checkbox"/>	100.00#	1673	378
	Aluminum Feet, Contrast	MP48SQR/AFT/FC	<input type="checkbox"/> <input type="checkbox"/> <input type="checkbox"/> <input type="checkbox"/>	<input type="checkbox"/> <input type="checkbox"/> <input type="checkbox"/> <input type="checkbox"/>		<input type="checkbox"/> <input type="checkbox"/>	<input type="checkbox"/> <input type="checkbox"/>	100.00#	1811	378
M48S 48" Square - Contrast • 1 = Base (Fabric Contrast 1) C.O.M. = 2.75 yd • 2 = Seat (Fabric Contrast 2) C.O.M. = 1.75 yd • Ganging (specify kit separately) • W=47.5" D=47.5" H=18"										
A B C D E F										

HOW TO ORDER

- Indicate the following information on order form:
- Quantity of each item.
 - Model number, including options. See "How To Build a Model Number".
 - Any special service required.

Note:

- The indicates that a choice is required.
- The absence of the indicates that no choice is required.
- Alpha-numeric characters in place of indicate that no other alternatives are available.

HOW TO BUILD A MODEL NUMBER

See pricing column for moisture barrier upcharge.

- A** Select basic model.
- B** Select non-contrast or fabric contrast 1. Refer to ki.com/fabrics.
• For yardage pricing, see Fabric Yardage Pricing page
- C** Select fabric contrast 2. Refer to ki.com/fabrics.
• For yardage pricing, see Fabric Yardage Pricing page
- D** Select wood feet finish. Refer to the **Product Color Options** page in this price list.
- E** Select brushed aluminum feet finish. Refer to the **Product Color Options** page in this price list.
- F** Select moisture barrier.

MB	- Moisture barrier
NMB	- No moisture barrier

SPECIAL SERVICES

Special Carton Marking

With specially marked information N/C

Shipping

Ships **assembled, FOB High Point, NC 27263, freight prepaid.** Freight class 250.

Specifications and prices are subject to change without prior notice.



Features	MODEL NUMBER						Approx. Packaged Weight	Delivered Pricing	Moisture Barrier add to list price	
	Basic Model	Non-Contrast or Fabric Contrast 1	Fabric Contrast 2	Wood Feet Finish	Aluminum Feet Finish	Moisture Barrier				
concealed glides shown 	Concealed Glides, Non-contrast	MP48H/CGL/NC	<input type="checkbox"/> <input type="checkbox"/> <input type="checkbox"/> <input type="checkbox"/>				<input type="checkbox"/> <input type="checkbox"/>	100.00#	\$ 1602	\$ 378
	Poly Feet, Non-contrast	MP48H/PFT/NC	<input type="checkbox"/> <input type="checkbox"/> <input type="checkbox"/> <input type="checkbox"/>				<input type="checkbox"/> <input type="checkbox"/>	100.00#	1673	378
	Wood Feet, Non-contrast	MP48H/WFT/NC	<input type="checkbox"/> <input type="checkbox"/> <input type="checkbox"/> <input type="checkbox"/>		<input type="checkbox"/> <input type="checkbox"/>		<input type="checkbox"/> <input type="checkbox"/>	100.00#	1806	378
	Casters, Non-contrast	MP48H/CST/NC	<input type="checkbox"/> <input type="checkbox"/> <input type="checkbox"/> <input type="checkbox"/>				<input type="checkbox"/> <input type="checkbox"/>	100.00#	1673	378
	Aluminum Feet, Non-contrast	MP48H/AFT/NC	<input type="checkbox"/> <input type="checkbox"/> <input type="checkbox"/> <input type="checkbox"/>			<input type="checkbox"/>	<input type="checkbox"/> <input type="checkbox"/>	100.00#	1811	378
M48H 48" Hexagon - Non-contrast • Non-contrast C.O.M = 5.25 yds • Ganging (specify kit seperately) Overall Dimensions: • W=55.5" D=48" H=18"										
concealed glides shown 	Concealed Glides, Contrast	MP48H/CGL/FC	<input type="checkbox"/> <input type="checkbox"/> <input type="checkbox"/> <input type="checkbox"/>	<input type="checkbox"/> <input type="checkbox"/> <input type="checkbox"/> <input type="checkbox"/>			<input type="checkbox"/> <input type="checkbox"/>	100.00#	\$ 1632	\$ 378
	Poly Feet, Non-contrast	MP48H/PFT/FC	<input type="checkbox"/> <input type="checkbox"/> <input type="checkbox"/> <input type="checkbox"/>	<input type="checkbox"/> <input type="checkbox"/> <input type="checkbox"/> <input type="checkbox"/>			<input type="checkbox"/> <input type="checkbox"/>	100.00#	1704	378
	Wood Feet, Contrast	MP48H/WFT/FC	<input type="checkbox"/> <input type="checkbox"/> <input type="checkbox"/> <input type="checkbox"/>	<input type="checkbox"/> <input type="checkbox"/> <input type="checkbox"/> <input type="checkbox"/>	<input type="checkbox"/> <input type="checkbox"/>		<input type="checkbox"/> <input type="checkbox"/>	100.00#	1836	378
	Casters, Contrast	MP48H/CST/FC	<input type="checkbox"/> <input type="checkbox"/> <input type="checkbox"/> <input type="checkbox"/>	<input type="checkbox"/> <input type="checkbox"/> <input type="checkbox"/> <input type="checkbox"/>			<input type="checkbox"/> <input type="checkbox"/>	100.00#	1704	378
	Aluminum Feet, Contrast	MP48H/AFT/FC	<input type="checkbox"/> <input type="checkbox"/> <input type="checkbox"/> <input type="checkbox"/>	<input type="checkbox"/> <input type="checkbox"/> <input type="checkbox"/> <input type="checkbox"/>		<input type="checkbox"/>	<input type="checkbox"/> <input type="checkbox"/>	100.00#	1842	378
M48H 48" Hexagon - Contrast • 1 = Base (Fabric Contrast 1) C.O.M. = 3.75 yd • 2 = Seat (Fabric Contrast 2) C.O.M. = 2 yd • Ganging (specify kit seperately) Overall Dimensions: • W=55.5" D=48" H=18"										
	A	B	C	D	E	F				

HOW TO ORDER

Indicate the following information on order form:

- Quantity of each item.
- Model number, including options. See "How To Build a Model Number".
- Any special service required.

Note:

- The indicates that a choice is required.
- The absence of the indicates that no choice is required.
- Alpha-numeric characters in place of indicate that no other alternatives are available.

HOW TO BUILD A MODEL NUMBER

See pricing column for moisture barrier upcharge.

A Select basic model.

B Select non-contrast or fabric contrast 1. Refer to ki.com/fabrics.
 • For yardage pricing, see Fabric Yardage Pricing page

C Select fabric contrast 2. Refer to ki.com/fabrics.
 • For yardage pricing, see Fabric Yardage Pricing page

D Select wood feet finish. Refer to the **Product Color Options** page in this price list.

E Select brushed aluminum feet finish. Refer to the **Product Color Options** page in this price list.









F Select moisture barrier.
MB - Moisture barrier
NMB - No moisture barrier

SPECIAL SERVICES

Special Carton Marking
 With specially marked information N/C

Shipping
 Ships assembled, FOB High Point, NC 27263, freight prepaid. Freight class 250.

Specifications and prices are subject to change without prior notice.

MODEL	Features	MODEL NUMBER					Approx. Packaged Weight	Delivered Pricing	Moisture Barrier add to list price	
		Basic Model	Non-Contrast or Fabric Contrast 1	Fabric Contrast 2	Wood Feet Finish	Moisture Barrier				
concealed glides shown     MJ18R	Junior 18" Round - Non-contrast • Non-contrast C.O.M = 1.25 yds • Dia=18" H=14"	Concealed Glide, Non-contrast	MPJ18R/CGL/NC	<input type="checkbox"/> <input type="checkbox"/> <input type="checkbox"/> <input type="checkbox"/>				25.00#	\$ 645	\$ 101
		Poly Feet, Non-contrast	MPJ18R/PFT/NC	<input type="checkbox"/> <input type="checkbox"/> <input type="checkbox"/> <input type="checkbox"/>				25.00#	645	101
		Wood Feet, Non-contrast	MPJ18R/WFT/NC	<input type="checkbox"/> <input type="checkbox"/> <input type="checkbox"/> <input type="checkbox"/>		<input type="checkbox"/> <input type="checkbox"/> <input type="checkbox"/> <input type="checkbox"/>	<input type="checkbox"/> <input type="checkbox"/> <input type="checkbox"/> <input type="checkbox"/>	25.00#	775	101
		Casters, Non-contrast	MPJ18R/CST/NC	<input type="checkbox"/> <input type="checkbox"/> <input type="checkbox"/> <input type="checkbox"/>			<input type="checkbox"/> <input type="checkbox"/> <input type="checkbox"/> <input type="checkbox"/>	25.00#	645	101
		Active Base, Non-contrast	MPJ18R/ABO/NC	<input type="checkbox"/> <input type="checkbox"/> <input type="checkbox"/> <input type="checkbox"/>			<input type="checkbox"/> <input type="checkbox"/> <input type="checkbox"/> <input type="checkbox"/>	25.00#	740	101
concealed glides shown     MJ18R	Junior 18" Round - Contrast • 1 = Base (Fabric Contrast 1) C.O.M. = 1.25 yd • 2 = Seat (Fabric Contrast 2) C.O.M. = .75 yd • Dia=18" H=14"	Concealed Glide, Contrast	MPJ18R/CGL/FC	<input type="checkbox"/> <input type="checkbox"/> <input type="checkbox"/> <input type="checkbox"/>	<input type="checkbox"/> <input type="checkbox"/> <input type="checkbox"/> <input type="checkbox"/>			25.00#	\$ 678	\$ 101
		Poly Feet, Contrast	MPJ18R/PFT/FC	<input type="checkbox"/> <input type="checkbox"/> <input type="checkbox"/> <input type="checkbox"/>	<input type="checkbox"/> <input type="checkbox"/> <input type="checkbox"/> <input type="checkbox"/>		<input type="checkbox"/> <input type="checkbox"/> <input type="checkbox"/> <input type="checkbox"/>	25.00#	678	101
		Wood Feet, Contrast	MPJ18R/WFT/FC	<input type="checkbox"/> <input type="checkbox"/> <input type="checkbox"/> <input type="checkbox"/>	<input type="checkbox"/> <input type="checkbox"/> <input type="checkbox"/> <input type="checkbox"/>	<input type="checkbox"/> <input type="checkbox"/> <input type="checkbox"/> <input type="checkbox"/>	<input type="checkbox"/> <input type="checkbox"/> <input type="checkbox"/> <input type="checkbox"/>	25.00#	807	101
		Casters, Contrast	MPJ18R/CST/FC	<input type="checkbox"/> <input type="checkbox"/> <input type="checkbox"/> <input type="checkbox"/>	<input type="checkbox"/> <input type="checkbox"/> <input type="checkbox"/> <input type="checkbox"/>		<input type="checkbox"/> <input type="checkbox"/> <input type="checkbox"/> <input type="checkbox"/>	25.00#	678	101
		Active Base, Contrast	MPJ18R/ABO/FC	<input type="checkbox"/> <input type="checkbox"/> <input type="checkbox"/> <input type="checkbox"/>	<input type="checkbox"/> <input type="checkbox"/> <input type="checkbox"/> <input type="checkbox"/>		<input type="checkbox"/> <input type="checkbox"/> <input type="checkbox"/> <input type="checkbox"/>	25.00#	765	101

A

B

C

D

E

HOW TO ORDER

Indicate the following information on order form:

- Quantity of each item.
- Model number, including options. See "How To Build a Model Number".
- Any special service required.

Note: • The indicates that a choice is required.

- The absence of the indicates that no choice is required.
- Alpha-numeric characters in place of indicate that no other alternatives are available.

HOW TO BUILD A MODEL NUMBER





- A** Select basic model.
- B** Select non-contrast or fabric contrast 1.
Refer to ki.com/fabrics.
• For yardage pricing, see Fabric Yardage Pricing page
- C** Select fabric contrast 2.
Refer to ki.com/fabrics.
• For yardage pricing, see Fabric Yardage Pricing page
- D** Select wood feet finish.
Refer to the **Product Color Options** page in this price list.
- E** Select moisture barrier.
MB - Moisture barrier
NMB - No moisture barrier
See pricing column for moisture barrier upcharge.

SPECIAL SERVICES**Special Carton Marking**

With specially marked information N/C

ShippingShips **assembled, FOB High Point, NC 27263, freight prepaid.** Freight class 250.

Specifications and prices are subject to change without prior notice.

MODEL	Features	MODEL NUMBER					Approx. Packaged Weight	Delivered Pricing	Moisture Barrier add to list price	
		Basic Model	Non-Contrast or Fabric Contrast 1	Fabric Contrast 2	Wood Feet Finish	Moisture Barrier				
concealed glides shown   MJ18C	Junior 18" Cube - Non-contrast • Non-contrast C.O.M = 1.5 yds Overall Dimensions: • W=18" D=18" H=14"	Concealed Glides, Non-contrast	MPJ18C/CGL/NC	<input type="checkbox"/> <input type="checkbox"/> <input type="checkbox"/> <input type="checkbox"/>			<input type="checkbox"/> <input type="checkbox"/> <input type="checkbox"/>	26.50#	\$ 740	\$ 196
	Poly Feet, Non-contrast	MPJ18C/PFT/NC	<input type="checkbox"/> <input type="checkbox"/> <input type="checkbox"/> <input type="checkbox"/>			<input type="checkbox"/> <input type="checkbox"/> <input type="checkbox"/>	25.50#	740	196	
	Wood Feet, Non-contrast	MPJ18C/WFT/NC	<input type="checkbox"/> <input type="checkbox"/> <input type="checkbox"/> <input type="checkbox"/>		<input type="checkbox"/> <input type="checkbox"/> <input type="checkbox"/>	<input type="checkbox"/> <input type="checkbox"/> <input type="checkbox"/>	25.50#	870	196	
	Casters, Non-contrast	MPJ18C/CST/NC	<input type="checkbox"/> <input type="checkbox"/> <input type="checkbox"/> <input type="checkbox"/>			<input type="checkbox"/> <input type="checkbox"/> <input type="checkbox"/>	25.50#	740	196	
concealed glides shown   MJ18C	Junior 18" Cube - Contrast • 1 = Base (Fabric Contrast 1) C.O.M. = 1.25 yd • 2 = Seat (Fabric Contrast 2) C.O.M. = .75 yd Overall Dimensions: • W=18" D=18" H=14"	Concealed Glides, Contrast	MPJ18C/CGL/FC	<input type="checkbox"/> <input type="checkbox"/> <input type="checkbox"/> <input type="checkbox"/>	<input type="checkbox"/> <input type="checkbox"/> <input type="checkbox"/> <input type="checkbox"/>	<input type="checkbox"/> <input type="checkbox"/> <input type="checkbox"/>	26.50#	\$ 767	\$ 196	
	Poly Feet, Contrast	MPJ18C/PFT/FC	<input type="checkbox"/> <input type="checkbox"/> <input type="checkbox"/> <input type="checkbox"/>	<input type="checkbox"/> <input type="checkbox"/> <input type="checkbox"/> <input type="checkbox"/>		<input type="checkbox"/> <input type="checkbox"/> <input type="checkbox"/>	25.50#	767	196	
	Wood Feet, Contrast	MPJ18C/WFT/FC	<input type="checkbox"/> <input type="checkbox"/> <input type="checkbox"/> <input type="checkbox"/>	<input type="checkbox"/> <input type="checkbox"/> <input type="checkbox"/> <input type="checkbox"/>	<input type="checkbox"/> <input type="checkbox"/> <input type="checkbox"/>	<input type="checkbox"/> <input type="checkbox"/> <input type="checkbox"/>	25.50#	901	196	
	Casters, Contrast	MPJ18C/CST/FC	<input type="checkbox"/> <input type="checkbox"/> <input type="checkbox"/> <input type="checkbox"/>	<input type="checkbox"/> <input type="checkbox"/> <input type="checkbox"/> <input type="checkbox"/>		<input type="checkbox"/> <input type="checkbox"/> <input type="checkbox"/>	25.50#	767	196	
				A	B	C	D	E		

HOW TO ORDER

Indicate the following information on order form:

- Quantity of each item.
- Model number, including options. See "How To Build a Model Number".
- Any special service required.

Note: • The indicates that a choice is required.

- The absence of the indicates that no choice is required.
- Alpha-numeric characters in place of indicate that no other alternatives are available.

HOW TO BUILD A MODEL NUMBER

- A** Select basic model.
- B** Select non-contrast or fabric contrast 1.
Refer to ki.com/fabrics.
• For yardage pricing, see Fabric Yardage Pricing page
- C** Select fabric contrast 2.
Refer to ki.com/fabrics.
• For yardage pricing, see Fabric Yardage Pricing page
- D** Select wood feet finish.
Refer to the **Product Color Options** page in this price list.
- E** Select moisture barrier.
MB - Moisture barrier
NMB - No moisture barrier
See pricing column for moisture barrier upcharge.









SPECIAL SERVICES**Special Carton Marking**

With specially marked information N/C

Shipping

Ships **assembled, FOB High Point, NC 27263, freight prepaid.** Freight class 250.

Specifications and prices are subject to change without prior notice.

MODEL	Features	MODEL NUMBER					Approx. Packaged Weight	Delivered Pricing	Moisture Barrier add to list price	
		Basic Model	Non-Contrast or Fabric Contrast 1	Fabric Contrast 2	Wood Feet Finish	Moisture Barrier				
concealed glides shown    	Junior 18" Hexagon - Non-contrast • Non-contrast C.O.M = 1.5 yds Overall Dimensions: • W=20.75" D=18" H=14"	Concealed Glides, Non-contrast	MPJ18H/CGL/NC	<input type="checkbox"/> <input type="checkbox"/> <input type="checkbox"/> <input type="checkbox"/>			<input type="checkbox"/> <input type="checkbox"/> <input type="checkbox"/>	26.50#	\$ 740	\$ 194
		Poly Feet, Non-contrast	MPJ18H/PFT/NC	<input type="checkbox"/> <input type="checkbox"/> <input type="checkbox"/> <input type="checkbox"/>			<input type="checkbox"/> <input type="checkbox"/> <input type="checkbox"/>	25.50#	740	194
		Wood Feet, Non-contrast	MPJ18H/WFT/NC	<input type="checkbox"/> <input type="checkbox"/> <input type="checkbox"/> <input type="checkbox"/>		<input type="checkbox"/> <input type="checkbox"/> <input type="checkbox"/>	<input type="checkbox"/> <input type="checkbox"/> <input type="checkbox"/>	25.50#	870	194
		Casters, Non-contrast	MPJ18H/CST/NC	<input type="checkbox"/> <input type="checkbox"/> <input type="checkbox"/> <input type="checkbox"/>			<input type="checkbox"/> <input type="checkbox"/> <input type="checkbox"/>	25.50#	740	194
		Active Base, Non-contrast	MPJ18H/ABO/NC	<input type="checkbox"/> <input type="checkbox"/> <input type="checkbox"/> <input type="checkbox"/>			<input type="checkbox"/> <input type="checkbox"/> <input type="checkbox"/>	26.50#	847	194
		MJ18H								
concealed glides shown    	Junior 18" Hexagon - Contrast • 1 = Base (Fabric Contrast 1) C.O.M. = 1.25 yd • 2 = Seat (Fabric Contrast 2) C.O.M. = .75 yd Overall Dimensions: • W=20.75" D=18" H=14"	Concealed Glides, Contrast	MPJ18H/CGL/FC	<input type="checkbox"/> <input type="checkbox"/> <input type="checkbox"/> <input type="checkbox"/>		<input type="checkbox"/> <input type="checkbox"/> <input type="checkbox"/>	26.50#	\$ 767	\$ 194	
		Poly Feet, Contrast	MPJ18H/PFT/FC	<input type="checkbox"/> <input type="checkbox"/> <input type="checkbox"/> <input type="checkbox"/>			<input type="checkbox"/> <input type="checkbox"/> <input type="checkbox"/>	25.50#	767	194
		Wood Feet, Contrast	MPJ18H/WFT/FC	<input type="checkbox"/> <input type="checkbox"/> <input type="checkbox"/> <input type="checkbox"/>	<input type="checkbox"/> <input type="checkbox"/> <input type="checkbox"/> <input type="checkbox"/>	<input type="checkbox"/> <input type="checkbox"/> <input type="checkbox"/>	<input type="checkbox"/> <input type="checkbox"/> <input type="checkbox"/>	25.50#	901	194
		Casters, Contrast	MPJ18H/CST/FC	<input type="checkbox"/> <input type="checkbox"/> <input type="checkbox"/> <input type="checkbox"/>	<input type="checkbox"/> <input type="checkbox"/> <input type="checkbox"/> <input type="checkbox"/>		<input type="checkbox"/> <input type="checkbox"/> <input type="checkbox"/>	25.50#	767	194
		Active Base, Contrast	MPJ18H/ABO/FC	<input type="checkbox"/> <input type="checkbox"/> <input type="checkbox"/> <input type="checkbox"/>	<input type="checkbox"/> <input type="checkbox"/> <input type="checkbox"/> <input type="checkbox"/>		<input type="checkbox"/> <input type="checkbox"/> <input type="checkbox"/>	26.50#	873	194
		MJ18H								
		A	B	C	D	E				

HOW TO ORDER

Indicate the following information on order form:

- Quantity of each item.
- Model number, including options. See "How To Build a Model Number".
- Any special service required.

Note: • The indicates that a choice is required.

- The absence of the indicates that no choice is required.
- Alpha-numeric characters in place of indicate that no other alternatives are available.

HOW TO BUILD A MODEL NUMBER

- A** Select basic model.
- B** Select non-contrast or fabric contrast 1.
Refer to ki.com/fabrics.
• For yardage pricing, see Fabric Yardage Pricing page
- C** Select fabric contrast 2.
Refer to ki.com/fabrics.
• For yardage pricing, see Fabric Yardage Pricing page
- D** Select wood feet finish.
Refer to the **Product Color Options** page in this price list.
- E** Select moisture barrier.
MB - Moisture barrier
NMB - No moisture barrier
See pricing column for moisture barrier upcharge.

SPECIAL SERVICES**Special Carton Marking**



With specially marked information N/C

Shipping

Ships **assembled, FOB High Point, NC 27263, freight prepaid.** Freight class 250.

Specifications and prices are subject to change without prior notice.

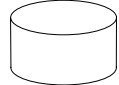

MODEL	Features	MODEL NUMBER					Approx. Packaged Weight	Delivered Pricing	Moisture Barrier add to list price	
		Basic Model	Non-Contrast or Fabric Contrast 1	Fabric Contrast 2	Wood Feet Finish	Moisture Barrier				
concealed glides shown  MJ26R	Junior 26" Round - Non-contrast • Non-contrast C.O.M = 2 yds • Ganging (specify kit separately) • Dia=26" H=14"	Concealed Glide, Non-contrast	MPJ26R/CGL/NC	<input type="checkbox"/> <input type="checkbox"/> <input type="checkbox"/> <input type="checkbox"/>			<input type="checkbox"/> <input type="checkbox"/> <input type="checkbox"/>	31.00#	\$ 760	\$ 122
		Poly Feet, Non-contrast	MPJ26R/PFT/NC	<input type="checkbox"/> <input type="checkbox"/> <input type="checkbox"/> <input type="checkbox"/>			<input type="checkbox"/> <input type="checkbox"/> <input type="checkbox"/>	31.00#	760	122
		Wood Feet, Non-contrast	MPJ26R/WFT/NC	<input type="checkbox"/> <input type="checkbox"/> <input type="checkbox"/> <input type="checkbox"/>		<input type="checkbox"/> <input type="checkbox"/> <input type="checkbox"/>	<input type="checkbox"/> <input type="checkbox"/> <input type="checkbox"/>	31.00#	892	122
		Casters, Non-contrast	MPJ26R/CST/NC	<input type="checkbox"/> <input type="checkbox"/> <input type="checkbox"/> <input type="checkbox"/>			<input type="checkbox"/> <input type="checkbox"/> <input type="checkbox"/>	31.00#	760	122
concealed glides shown  MJ26R	Junior 26" Round - Contrast • 1 = Base (Fabric Contrast 1) C.O.M. = 1.50 yd • 2 = Seat (Fabric Contrast 2) C.O.M. = 1 yd • Ganging (specify kit separately) • Dia=26" H=14"	Concealed Glide, Contrast	MPJ26R/CGL/FC	<input type="checkbox"/> <input type="checkbox"/> <input type="checkbox"/> <input type="checkbox"/>	<input type="checkbox"/> <input type="checkbox"/> <input type="checkbox"/> <input type="checkbox"/>		<input type="checkbox"/> <input type="checkbox"/> <input type="checkbox"/>	31.00#	\$ 795	\$ 122
		Poly Feet, Contrast	MPJ26R/PFT/FC	<input type="checkbox"/> <input type="checkbox"/> <input type="checkbox"/> <input type="checkbox"/>	<input type="checkbox"/> <input type="checkbox"/> <input type="checkbox"/> <input type="checkbox"/>		<input type="checkbox"/> <input type="checkbox"/> <input type="checkbox"/>	31.00#	795	122
		Wood Feet, Contrast	MPJ26R/WFT/FC	<input type="checkbox"/> <input type="checkbox"/> <input type="checkbox"/> <input type="checkbox"/>	<input type="checkbox"/> <input type="checkbox"/> <input type="checkbox"/> <input type="checkbox"/>	<input type="checkbox"/> <input type="checkbox"/> <input type="checkbox"/>	<input type="checkbox"/> <input type="checkbox"/> <input type="checkbox"/>	31.00#	925	122
		Casters, Contrast	MPJ26R/CST/FC	<input type="checkbox"/> <input type="checkbox"/> <input type="checkbox"/> <input type="checkbox"/>	<input type="checkbox"/> <input type="checkbox"/> <input type="checkbox"/> <input type="checkbox"/>		<input type="checkbox"/> <input type="checkbox"/> <input type="checkbox"/>	31.00#	795	122
				A	B	C	D	E		

HOW TO ORDER

- Indicate the following information on order form:
- Quantity of each item.
 - Model number, including options. See "How To Build a Model Number".
 - Any special service required.

Note:

- The indicates that a choice is required.
- The absence of the indicates that no choice is required.
- Alpha-numeric characters in place of indicate that no other alternatives are available.

HOW TO BUILD A MODEL NUMBER

- A** Select basic model.
- B** Select non-contrast or fabric contrast 1. Refer to ki.com/fabrics.
• For yardage pricing, see Fabric Yardage Pricing page
- C** Select fabric contrast 2. Refer to ki.com/fabrics.
• For yardage pricing, see Fabric Yardage Pricing page
- D** Select wood feet finish. Refer to the **Product Color Options** page in this price list.
- E** Select moisture barrier.
MB - Moisture barrier
NMB - No moisture barrier
See pricing column for moisture barrier upcharge.

SPECIAL SERVICES

Special Carton Marking

With specially marked information N/C

Shipping

Ships **assembled, FOB High Point, NC 27263, freight prepaid.** Freight class 250.

Specifications and prices are subject to change without prior notice.

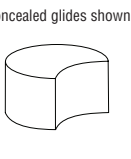
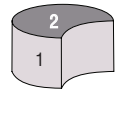
MODEL	Features	MODEL NUMBER					Approx. Packaged Weight	Delivered Pricing	Moisture Barrier add to list price	
		Basic Model	Non-Contrast or Fabric Contrast 1	Fabric Contrast 2	Wood Feet Finish	Moisture Barrier				
concealed glides shown 	Junior 26" Crescent - Non-contrast • Non-contrast C.O.M = 2 yds • Ganging (specify kit separately) • Dia=26" H=14"	Concealed Glide, Non-contrast	MPJCRE/CGL/NC	<input type="checkbox"/> <input type="checkbox"/> <input type="checkbox"/> <input type="checkbox"/>			<input type="checkbox"/> <input type="checkbox"/> <input type="checkbox"/> <input type="checkbox"/>	50.00#	\$ 789	\$ 200
		Poly Feet, Non-contrast	MPJCRE/PFT/NC	<input type="checkbox"/> <input type="checkbox"/> <input type="checkbox"/> <input type="checkbox"/>			<input type="checkbox"/> <input type="checkbox"/> <input type="checkbox"/> <input type="checkbox"/>	50.00#	789	200
		Wood Feet, Non-contrast	MPJCRE/WFT/NC	<input type="checkbox"/> <input type="checkbox"/> <input type="checkbox"/> <input type="checkbox"/>		<input type="checkbox"/> <input type="checkbox"/> <input type="checkbox"/> <input type="checkbox"/>	<input type="checkbox"/> <input type="checkbox"/> <input type="checkbox"/> <input type="checkbox"/>	50.00#	918	200
		Casters, Non-contrast	MPJCRE/CST/NC	<input type="checkbox"/> <input type="checkbox"/> <input type="checkbox"/> <input type="checkbox"/>			<input type="checkbox"/> <input type="checkbox"/> <input type="checkbox"/> <input type="checkbox"/>	50.00#	789	200
MJCRE										
concealed glides shown 	26" Junior Crescent - Contrast • 1 = Base (Fabric Contrast 1) C.O.M. = 1.75 yd • 2 = Seat (Fabric Contrast 2) C.O.M. = .75 yd • Ganging (specify kit separately) • Dia=26" H=14"	Concealed Glide, Contrast	MPJCRE/CGL/FC	<input type="checkbox"/> <input type="checkbox"/> <input type="checkbox"/> <input type="checkbox"/>	<input type="checkbox"/> <input type="checkbox"/> <input type="checkbox"/> <input type="checkbox"/>	<input type="checkbox"/> <input type="checkbox"/> <input type="checkbox"/> <input type="checkbox"/>	50.00#	\$ 823	\$ 200	
		Poly Feet, Contrast	MPJCRE/PFT/FC	<input type="checkbox"/> <input type="checkbox"/> <input type="checkbox"/> <input type="checkbox"/>	<input type="checkbox"/> <input type="checkbox"/> <input type="checkbox"/> <input type="checkbox"/>		<input type="checkbox"/> <input type="checkbox"/> <input type="checkbox"/> <input type="checkbox"/>	50.00#	823	200
		Wood Feet, Contrast	MPJCRE/WFT/FC	<input type="checkbox"/> <input type="checkbox"/> <input type="checkbox"/> <input type="checkbox"/>	<input type="checkbox"/> <input type="checkbox"/> <input type="checkbox"/> <input type="checkbox"/>	<input type="checkbox"/> <input type="checkbox"/> <input type="checkbox"/> <input type="checkbox"/>	<input type="checkbox"/> <input type="checkbox"/> <input type="checkbox"/> <input type="checkbox"/>	50.00#	951	200
		Casters, Contrast	MPJCRE/CST/FC	<input type="checkbox"/> <input type="checkbox"/> <input type="checkbox"/> <input type="checkbox"/>	<input type="checkbox"/> <input type="checkbox"/> <input type="checkbox"/> <input type="checkbox"/>		<input type="checkbox"/> <input type="checkbox"/> <input type="checkbox"/> <input type="checkbox"/>	50.00#	823	200
MJCRE										
			A	B	C	D	E			

HOW TO ORDER

- Indicate the following information on order form:
- Quantity of each item.
 - Model number, including options. See "How To Build a Model Number".
 - Any special service required.

Note:

- The indicates that a choice is required.
- The absence of the indicates that no choice is required.
- Alpha-numeric characters in place of indicate that no other alternatives are available.

HOW TO BUILD A MODEL NUMBER

- A** Select basic model.
- B** Select non-contrast or fabric contrast 1. Refer to ki.com/fabrics.
• For yardage pricing, see Fabric Yardage Pricing page
- C** Select fabric contrast 2. Refer to ki.com/fabrics.
• For yardage pricing, see Fabric Yardage Pricing page
- D** Select wood feet finish. Refer to the **Product Color Options** page in this price list.
- E** Select moisture barrier.
MB - Moisture barrier
NMB - No moisture barrier
See pricing column for moisture barrier upcharge.

SPECIAL SERVICES**Special Carton Marking**

With specially marked information N/C

Shipping

Ships **assembled, FOB High Point, NC 27263, freight prepaid.** Freight class 250.

Specifications and prices are subject to change without prior notice.

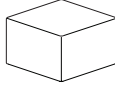
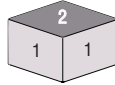

MODEL	Features	MODEL NUMBER					Approx. Packaged Weight	Delivered Pricing	Moisture Barrier add to list price	
		Basic Model	Non-Contrast or Fabric Contrast 1	Fabric Contrast 2	Wood Feet Finish	Moisture Barrier				
concealed glides shown  MJSQR	Junior 26" Square - Non-contrast • Non-contrast C.O.M = 1.75 yds • Ganging (specify kit separately) • W=26" D=26" H=14"	Concealed Glide, Non-contrast	MPJSQR/CGL/NC	<input type="checkbox"/> <input type="checkbox"/> <input type="checkbox"/> <input type="checkbox"/>				35.00#	\$ 794	\$ 195
		Poly Feet, Non-contrast	MPJSQR/PFT/NC	<input type="checkbox"/> <input type="checkbox"/> <input type="checkbox"/> <input type="checkbox"/>				35.00#	794	195
		Wood Feet, Non-contrast	MPJSQR/WFT/NC	<input type="checkbox"/> <input type="checkbox"/> <input type="checkbox"/> <input type="checkbox"/>		<input type="checkbox"/> <input type="checkbox"/> <input type="checkbox"/>	<input type="checkbox"/> <input type="checkbox"/> <input type="checkbox"/>	35.00#	923	195
		Casters, Non-contrast	MPJSQR/CST/NC	<input type="checkbox"/> <input type="checkbox"/> <input type="checkbox"/> <input type="checkbox"/>			<input type="checkbox"/> <input type="checkbox"/> <input type="checkbox"/>	35.00#	794	195
concealed glides shown  MJSQR	Junior 26" Square - Contrast • 1 = Base (Fabric Contrast 1) C.O.M. = 1 yd • 2 = Seat (Fabric Contrast 2) C.O.M. = .75 yd • Ganging (specify kit separately) • W=22" D=22" H=14"	Concealed Glide, Contrast	MPJSQR/CGL/FC	<input type="checkbox"/> <input type="checkbox"/> <input type="checkbox"/> <input type="checkbox"/>	<input type="checkbox"/> <input type="checkbox"/> <input type="checkbox"/> <input type="checkbox"/>			35.00#	\$ 826	\$ 195
		Poly Feet, Contrast	MPJSQR/PFT/FC	<input type="checkbox"/> <input type="checkbox"/> <input type="checkbox"/> <input type="checkbox"/>	<input type="checkbox"/> <input type="checkbox"/> <input type="checkbox"/> <input type="checkbox"/>			35.00#	826	195
		Wood Feet, Contrast	MPJSQR/WFT/FC	<input type="checkbox"/> <input type="checkbox"/> <input type="checkbox"/> <input type="checkbox"/>	<input type="checkbox"/> <input type="checkbox"/> <input type="checkbox"/> <input type="checkbox"/>	<input type="checkbox"/> <input type="checkbox"/> <input type="checkbox"/>	<input type="checkbox"/> <input type="checkbox"/> <input type="checkbox"/>	35.00#	955	195
		Casters, Contrast	MPJSQR/CST/FC	<input type="checkbox"/> <input type="checkbox"/> <input type="checkbox"/> <input type="checkbox"/>	<input type="checkbox"/> <input type="checkbox"/> <input type="checkbox"/> <input type="checkbox"/>		<input type="checkbox"/> <input type="checkbox"/> <input type="checkbox"/>	35.00#	826	195
				A	B	C	D	E		

HOW TO ORDER

- Indicate the following information on order form:
- Quantity of each item.
 - Model number, including options. See "How To Build a Model Number".
 - Any special service required.

Note:

- The indicates that a choice is required.
- The absence of the indicates that no choice is required.
- Alpha-numeric characters in place of indicate that no other alternatives are available.

HOW TO BUILD A MODEL NUMBER

- A** Select basic model.
- B** Select non-contrast or fabric contrast 1.
Refer to ki.com/fabrics.
• For yardage pricing, see Fabric Yardage Pricing page
- C** Select fabric contrast 2.
Refer to ki.com/fabrics.
• For yardage pricing, see Fabric Yardage Pricing page
- D** Select wood feet finish.
Refer to the **Product Color Options** page in this price list.
- E** Select moisture barrier.
MB - Moisture barrier
NMB - No moisture barrier
See pricing column for moisture barrier upcharge.

SPECIAL SERVICES

Special Carton Marking

With specially marked information N/C

Shipping

Ships **assembled, FOB High Point, NC 27263, freight prepaid.** Freight class 250.

Specifications and prices are subject to change without prior notice.



Features	MODEL NUMBER										Approx. Packaged Weight	Delivered Pricing	Moisture Barrier add to list price
	Basic Model	Non-Contrast or Fabric Contrast 1	Fabric Cont 2	Power Option	Power Location	Power Color	Wood Feet Finish	Alum-inum Feet Finish	Moist Barr				
concealed glides shown 	Concealed Glide, Non-contrast	MPRCT/CGL/NC	<input type="checkbox"/>		<input type="checkbox"/>	<input type="checkbox"/>	<input type="checkbox"/>			<input type="checkbox"/>	70.00#	\$ 1262	\$ 261
	Poly Feet, Non-contrast	MPRCT/PFT/NC	<input type="checkbox"/>		<input type="checkbox"/>	<input type="checkbox"/>	<input type="checkbox"/>			<input type="checkbox"/>	70.00#	1262	261
	Wood Feet, Non-contrast	MPRCT/WFT/NC	<input type="checkbox"/>		<input type="checkbox"/>	<input type="checkbox"/>	<input type="checkbox"/>	<input type="checkbox"/>		<input type="checkbox"/>	70.00#	1393	261
	Aluminum Feet, Non-Contrast	MPRCT/AFT/NC	<input type="checkbox"/>		<input type="checkbox"/>	<input type="checkbox"/>	<input type="checkbox"/>		<input type="checkbox"/>	<input type="checkbox"/>	70.00#	1405	261
MRCT Rectangle, Backless - Non-contrast													
<ul style="list-style-type: none"> Non-contrast C.O.M = 3.5 yds Ganging (specify kit separately) W=48" D=26" H=18" Casters unavailable as standard. 													
concealed glides shown 	Concealed Glide, Contrast	MPRCT/CGL/FC	<input type="checkbox"/>	<input type="checkbox"/>	<input type="checkbox"/>	<input type="checkbox"/>	<input type="checkbox"/>			<input type="checkbox"/>	70.00#	\$ 1295	\$ 261
	Poly Feet, Contrast	MPRCT/PFT/FC	<input type="checkbox"/>	<input type="checkbox"/>	<input type="checkbox"/>	<input type="checkbox"/>	<input type="checkbox"/>			<input type="checkbox"/>	70.00#	1295	261
	Wood Feet, Contrast	MPRCT/WFT/FC	<input type="checkbox"/>	<input type="checkbox"/>	<input type="checkbox"/>	<input type="checkbox"/>	<input type="checkbox"/>	<input type="checkbox"/>		<input type="checkbox"/>	70.00#	1425	261
	Aluminum Feet, Contrast	MPRCT/AFT/FC	<input type="checkbox"/>	<input type="checkbox"/>	<input type="checkbox"/>	<input type="checkbox"/>	<input type="checkbox"/>		<input type="checkbox"/>	<input type="checkbox"/>	70.00#	1438	261
MRCT Rectangle, Backless - Contrast													
<ul style="list-style-type: none"> 1 = Base (Fabric Contrast 1) C.O.M. = 2.5 yd 2 = Seat (Fabric Contrast 2) C.O.M. = 1 yd Ganging (specify kit separately) W=48" D=26" H=18" Casters unavailable as standard. 													
			A	B	C	D	E	F	G	H	I		

HOW TO ORDER

- Indicate the following information on order form:
- Quantity of each item.
 - Model number, including options. See "How To Build a Model Number".
 - Any special service required.

Note: • The indicates that a choice is required.
 • The absence of the indicates that no choice is required.
 • Alpha-numeric characters in place of indicate that no other alternatives are available.

HOW TO BUILD A MODEL NUMBER

- A** Select basic model.
- B** Non-contrast or fabric contrast 1
Refer to ki.com/fabrics.
 - For yardage pricing, see Fabric Yardage Pricing page
- C** Select fabric contrast 2.
Refer to ki.com/fabrics
 - For yardage pricing, see Fabric Yardage Pricing page
- D** Select power option.
RPT - Mini-Tap power module w/3-prong plug; add \$314
NP - No power
- E** Select Mini-Tap module w/3-prong plug location.
LFP - Left-facing power
RFP - Right-facing power
- F** Select module color.
MPB - Black power module
MPS - Silver power module
MPW - White power module
- G** Select wood feet finish.
Refer to the **Product Color Options** page in this price list.
- H** Select brushed aluminum feet finish.
Refer to the **Product Color Options** page in this price list.
- I** Select moisture barrier.
MB - Moisture barrier
NMB - No moisture barrier
 See pricing column for moisture barrier upcharge.

SPECIAL SERVICES

Special Carton Marking

With specially marked information N/C

Shipping

Ships **assembled, FOB High Point, NC 27263, freight prepaid.** Freight class 250.

Specifications and prices are subject to change without prior notice.



Features	MODEL NUMBER										Approx. Packaged Weight	Delivered Pricing	Moisture Barrier add to list price	
	Basic Model	Non-Contrast or Fabric Contrast 1	Fabric Cont 2	Power Option	Power Location	Power Color	Wood Feet Finish	Aluminum Feet Finish	Moist Barr					
concealed glides shown MC30 Backless, 30° Curve - Non-contrast • Non-contrast C.O.M = 2.25 yds • Ganging (specify kit separately) Overall Dimensions: • W=28" D=26" H=18"	Concealed Glide, Non-contrast	MPC30/CGL/NC	<input type="checkbox"/>			<input type="checkbox"/>	<input type="checkbox"/>	<input type="checkbox"/>				51.50#	\$ 899	\$ 203
	Poly Feet, Non-contrast	MPC30/PFT/NC	<input type="checkbox"/>			<input type="checkbox"/>	<input type="checkbox"/>	<input type="checkbox"/>				50.50#	899	203
	Wood Feet, Non-contrast	MPC30/WFT/NC	<input type="checkbox"/>			<input type="checkbox"/>	<input type="checkbox"/>	<input type="checkbox"/>	<input type="checkbox"/>			50.50#	1030	203
	Casters, Non-contrast	MPC30/CST/NC	<input type="checkbox"/>			<input type="checkbox"/>	<input type="checkbox"/>	<input type="checkbox"/>				50.50#	899	203
	Aluminum Feet, Non-contrast	MPC30/AFT/NC	<input type="checkbox"/>			<input type="checkbox"/>	<input type="checkbox"/>	<input type="checkbox"/>		<input type="checkbox"/>		51.50#	1030	203
concealed glides shown MC30 Backless, 30° Curve - Contrast • 1 = Base (Fabric Contrast 1) C.O.M. = 1.75 yd • 2 = Seat (Fabric Contrast 2) C.O.M. = 1 yd • Ganging (specify kit separately) Overall Dimensions: • W=28" D=26" H=18"	Concealed Glide, Contrast	MPC30/CGL/FC	<input type="checkbox"/>	<input type="checkbox"/>	<input type="checkbox"/>	<input type="checkbox"/>	<input type="checkbox"/>				50.50#	\$ 924	\$ 203	
	Poly Feet, Contrast	MPC30/PFT/FC	<input type="checkbox"/>	<input type="checkbox"/>	<input type="checkbox"/>	<input type="checkbox"/>	<input type="checkbox"/>				50.50#	924	203	
	Wood Feet, Contrast	MPC30/WFT/FC	<input type="checkbox"/>	<input type="checkbox"/>	<input type="checkbox"/>	<input type="checkbox"/>	<input type="checkbox"/>	<input type="checkbox"/>			50.50#	1057	203	
	Casters, Contrast	MPC30/CST/FC	<input type="checkbox"/>	<input type="checkbox"/>	<input type="checkbox"/>	<input type="checkbox"/>	<input type="checkbox"/>				50.50#	924	203	
	Aluminum Feet, Contrast	MPC30/AFT/FC	<input type="checkbox"/>	<input type="checkbox"/>	<input type="checkbox"/>	<input type="checkbox"/>	<input type="checkbox"/>		<input type="checkbox"/>		51.50#	1030	203	
			A	B	C	D	E	F	G	H	I			

HOW TO ORDER

- Indicate the following information on order form:
- Quantity of each item.
 - Model number, including options. See "How To Build a Model Number".
 - Any special service required.

Note: • The indicates that a choice is required.
 • The absence of the indicates that no choice is required.
 • Alpha-numeric characters in place of indicate that no other alternatives are available.

HOW TO BUILD A MODEL NUMBER

- A** Select basic model.
- B** Non-contrast or fabric contrast 1
Refer to ki.com/fabrics.
• For yardage pricing, see Fabric Yardage Pricing page
- C** Select fabric contrast 2.
Refer to ki.com/fabrics
• For yardage pricing, see Fabric Yardage Pricing page
- D** Select power option.

RPT	- Mini-Tap power module w/3-prong plug; add \$314
NP	- No power
- E** Select Mini-Tap module w/3-prong plug location.

ICLF	- Inside curve left facing power
OCLF	- Outside curve left facing power
ICRF	- Inside curve right facing power
OCRF	- Outside curve right facing power
- F** Select module color.

MPB	- Black power module
MPS	- Silver power module
MPW	- White power module
- G** Select wood feet finish.
Refer to the **Product Color Options** page in this price list.
- H** Select brushed aluminum feet finish.
Refer to the **Product Color Options** page in this price list.
- I** Select moisture barrier.

MB	- Moisture barrier
NMB	- No moisture barrier

 See pricing column for moisture barrier upcharge.

SPECIAL SERVICES

Special Carton Marking

With specially marked information N/C

Shipping

Ships assembled, FOB High Point, NC 27263, freight prepaid. Freight class 250.

Specifications and prices are subject to change without prior notice.



Features	MODEL NUMBER										Approx. Packaged Weight	Delivered Pricing	Moisture Barrier add to list price
	Basic Model	Non-Contrast or Fabric Contrast 1	Fabric Cont 2	Power Option	Power Location	Power Color	Wood Feet Finish	Aluminum Feet Finish	Moist Barr				
concealed glides shown MC45 Backless, 45° Curve - Non-contrast • Non-contrast C.O.M = 2.75 yds • Ganging (specify kit separately) Overall Dimensions: • W=41.5" D=26" H=18"	Concealed Glide, Non-contrast	MPC45/CGL/NC	<input type="checkbox"/>		<input type="checkbox"/>	<input type="checkbox"/>	<input type="checkbox"/>			<input type="checkbox"/>	53.00#	\$ 1166	\$ 208
	Poly Feet, Non-contrast	MPC45/PFT/NC	<input type="checkbox"/>		<input type="checkbox"/>	<input type="checkbox"/>	<input type="checkbox"/>			<input type="checkbox"/>	51.00#	1166	208
	Wood Feet, Non-contrast	MPC45/WFT/NC	<input type="checkbox"/>		<input type="checkbox"/>	<input type="checkbox"/>	<input type="checkbox"/>	<input type="checkbox"/>		<input type="checkbox"/>	51.00#	1299	208
	Casters, Non-contrast	MPC45/CST/NC	<input type="checkbox"/>		<input type="checkbox"/>	<input type="checkbox"/>	<input type="checkbox"/>			<input type="checkbox"/>	51.00#	1166	208
	Aluminum Feet, Non-Contrast	MPC45/AFT/NC	<input type="checkbox"/>		<input type="checkbox"/>	<input type="checkbox"/>	<input type="checkbox"/>		<input type="checkbox"/>	<input type="checkbox"/>	51.00#	1299	208
concealed glides shown MC45 Backless, 45° Curve - Contrast • 1 = Base (Fabric Contrast 1) C.O.M. = 1.75 yd • 2 = Seat (Fabric Contrast 2) C.O.M. = 1 yd • Ganging (specify kit separately) Overall Dimensions: • W=41.5" D=26" H=18"	Concealed Glide, Contrast	MPC45/CGL/FC	<input type="checkbox"/>	<input type="checkbox"/>	<input type="checkbox"/>	<input type="checkbox"/>	<input type="checkbox"/>			<input type="checkbox"/>	53.00#	\$ 1199	\$ 208
	Poly Feet, Contrast	MPC45/PFT/FC	<input type="checkbox"/>	<input type="checkbox"/>	<input type="checkbox"/>	<input type="checkbox"/>	<input type="checkbox"/>			<input type="checkbox"/>	51.00#	1199	208
	Wood Feet, Contrast	MPC45/WFT/FC	<input type="checkbox"/>	<input type="checkbox"/>	<input type="checkbox"/>	<input type="checkbox"/>	<input type="checkbox"/>	<input type="checkbox"/>		<input type="checkbox"/>	51.00#	1334	208
	Casters, Contrast	MPC45/CST/FC	<input type="checkbox"/>	<input type="checkbox"/>	<input type="checkbox"/>	<input type="checkbox"/>	<input type="checkbox"/>			<input type="checkbox"/>	51.00#	1199	208
	Aluminum Feet, Contrast	MPC45/AFT/FC	<input type="checkbox"/>	<input type="checkbox"/>	<input type="checkbox"/>	<input type="checkbox"/>	<input type="checkbox"/>		<input type="checkbox"/>	<input type="checkbox"/>	51.00#	1299	208
			A	B	C	D	E	F	G	H	I		

HOW TO ORDER

- Indicate the following information on order form:
- Quantity of each item.
 - Model number, including options. See "How To Build a Model Number".
 - Any special service required.

Note: • The indicates that a choice is required.
 • The absence of the indicates that no choice is required.
 • Alpha-numeric characters in place of indicate that no other alternatives are available.

HOW TO BUILD A MODEL NUMBER

- A** Select basic model.
- B** Non-contrast or fabric contrast 1
Refer to ki.com/fabrics.
• For yardage pricing, see Fabric Yardage Pricing page
- C** Select fabric contrast 2.
Refer to ki.com/fabrics
• For yardage pricing, see Fabric Yardage Pricing page
- D** Select power option.
RPT - Mini-Tap power module w/3-prong plug; add \$314
NP - No power
- E** Select Mini-Tap module w/3-prong plug location.
ICLF - Inside curve left facing power
OCLF - Outside curve left facing power
ICRF - Inside curve right facing power
OCRF - Outside curve right facing power
- F** Select module color.
MPB - Black power module
MPS - Silver power module
MPW - White power module
- G** Select wood feet finish.
Refer to the **Product Color Options** page in this price list.
- H** Select brushed aluminum feet finish.
Refer to the **Product Color Options** page in this price list.
- I** Select moisture barrier.
MB - Moisture barrier
NMB - No moisture barrier
See pricing column for moisture barrier upcharge.

SPECIAL SERVICES

Special Carton Marking

With specially marked information N/C

Shipping

Ships **assembled, FOB High Point, NC 27263, freight prepaid.** Freight class 250.

Specifications and prices are subject to change without prior notice.



Features	MODEL NUMBER										Approx. Packaged Weight	Delivered Pricing	Moisture Barrier add to list price	
	Basic Model	Non-Contrast or Fabric Contrast 1	Fabric Cont 2	Power Option	Power Location	Power Color	Wood Feet Finish	Alum-inum Feet Finish	Moist Barr					
concealed glides shown MC60 Backless, 60° Curve - Non-contrast • Non-contrast C.O.M = 3 yds • Ganging (specify kit separately) Overall Dimensions: • W=54" D=26" H=18" • Casters unavailable as standard.	Concealed Glide, Non-contrast	MPC60/CGL/NC	<input type="checkbox"/>			<input type="checkbox"/>	<input type="checkbox"/>	<input type="checkbox"/>				67.00#	\$ 1304	\$ 208
	Poly Feet, Non-contrast	MPC60/PFT/NC	<input type="checkbox"/>			<input type="checkbox"/>	<input type="checkbox"/>	<input type="checkbox"/>				67.00#	1304	208
	Wood Feet, Non-contrast	MPC60/WFT/NC	<input type="checkbox"/>			<input type="checkbox"/>	<input type="checkbox"/>	<input type="checkbox"/>	<input type="checkbox"/>			67.00#	1436	208
	Aluminum Feet, Non-Contrast	MPC60/AFT/NC	<input type="checkbox"/>			<input type="checkbox"/>	<input type="checkbox"/>	<input type="checkbox"/>	<input type="checkbox"/>	<input type="checkbox"/>		67.00#	1436	208
concealed glides shown MC60 Backless, 60° Curve - Contrast • 1 = Base (Fabric Contrast 1) C.O.M. = 2.25 yd • 2 = Seat (Fabric Contrast 2) C.O.M. = 1.25 yd • Ganging (specify kit separately) Overall Dimensions: • W=54" D=26" H=18" • Casters unavailable as standard.	Concealed Glide, Contrast	MPC60/CGL/FC	<input type="checkbox"/>	<input type="checkbox"/>	<input type="checkbox"/>	<input type="checkbox"/>	<input type="checkbox"/>				67.00#	\$ 1340	\$ 208	
	Poly Feet, Contrast	MPC60/PFT/FC	<input type="checkbox"/>	<input type="checkbox"/>	<input type="checkbox"/>	<input type="checkbox"/>	<input type="checkbox"/>				67.00#	1340	208	
	Wood Feet, Contrast	MPC60/WFT/FC	<input type="checkbox"/>	<input type="checkbox"/>	<input type="checkbox"/>	<input type="checkbox"/>	<input type="checkbox"/>	<input type="checkbox"/>			67.00#	1474	208	
	Aluminum Feet, Contrast	MPC60/AFT/FC	<input type="checkbox"/>	<input type="checkbox"/>	<input type="checkbox"/>	<input type="checkbox"/>	<input type="checkbox"/>	<input type="checkbox"/>	<input type="checkbox"/>	<input type="checkbox"/>	67.00#	1436	208	
			A	B	C	D	E	F	G	H	I			

HOW TO ORDER

- Indicate the following information on order form:
- Quantity of each item.
 - Model number, including options. See "How To Build a Model Number".
 - Any special service required.

Note: • The indicates that a choice is required.
 • The absence of the indicates that no choice is required.
 • Alpha-numeric characters in place of indicate that no other alternatives are available.

HOW TO BUILD A MODEL NUMBER

- A** Select basic model.
- B** Non-contrast or fabric contrast 1
Refer to ki.com/fabrics.
• For yardage pricing, see Fabric Yardage Pricing page
- C** Select fabric contrast 2.
Refer to ki.com/fabrics
• For yardage pricing, see Fabric Yardage Pricing page
- D** Select power option.
RPT - Mini-Tap power module w/3-prong plug; add \$314
NP - No power
- E** Select Mini-Tap module w/3-prong plug location.
ICLF - Inside curve left facing power
OCLF - Outside curve left facing power
ICRF - Inside curve right facing power
OCRF - Outside curve right facing power
- F** Select module color.
MPB - Black power module
MPS - Silver power module
MPW - White power module
- G** Select wood feet finish.
Refer to the **Product Color Options** page in this price list.
- H** Select brushed aluminum feet finish.
Refer to the **Product Color Options** page in this price list.
- I** Select moisture barrier.
MB - Moisture barrier
NMB - No moisture barrier
See pricing column for moisture barrier upcharge.

SPECIAL SERVICES

Special Carton Marking
With specially marked information N/C

Shipping
Ships **assembled, FOB High Point, NC 27263, freight prepaid.** Freight class 250.

Specifications and prices are subject to change without prior notice.



Features	MODEL NUMBER										Approx. Packaged Weight	Delivered Pricing	Moisture Barrier add to list price	
	Basic Model	Non-Contrast or Fabric Contrast 1	Fabric Cont 2	Power Option	Power Location	Power Color	Wood Feet Finish	Alum-inum Feet Finish	Moist Barr					
concealed glides shown MCRV Backless, 90° Curve - Non-contrast • Non-contrast C.O.M = 4.5 yds • Ganging (specify kit separately) • W=76-1/2" D=26" H=18" • Casters unavailable as standard.	Concealed Glide, Non-contrast	MPCR/CGL/NC	<input type="checkbox"/>			<input type="checkbox"/>	<input type="checkbox"/>	<input type="checkbox"/>				116.00#	\$ 1549	\$ 272
	Poly Feet, Non-contrast	MPCR/PFT/NC	<input type="checkbox"/>			<input type="checkbox"/>	<input type="checkbox"/>	<input type="checkbox"/>				116.00#	1549	272
	Wood Feet, Non-contrast	MPCR/WFT/NC	<input type="checkbox"/>			<input type="checkbox"/>	<input type="checkbox"/>	<input type="checkbox"/>	<input type="checkbox"/>			116.00#	1680	272
	Aluminum Feet, Non-Contrast	MPCR/AFT/NC	<input type="checkbox"/>			<input type="checkbox"/>	<input type="checkbox"/>	<input type="checkbox"/>	<input type="checkbox"/>	<input type="checkbox"/>		116.00#	1665	272
concealed glides shown MCRV Backless, 90° Curve - Contrast • 1 = Base (Fabric Contrast 1) C.O.M. = 3 yd • 2 = Seat (Fabric Contrast 2) C.O.M. = 2 yd • Ganging (specify kit separately) • W=76-1/2" D=26" H=18" • Casters unavailable as standard.	Concealed Glide, Contrast	MPCR/CGL/FC	<input type="checkbox"/>	<input type="checkbox"/>	<input type="checkbox"/>	<input type="checkbox"/>	<input type="checkbox"/>				116.00#	\$ 1580	\$ 272	
	Poly Feet, Contrast	MPCR/PFT/FC	<input type="checkbox"/>	<input type="checkbox"/>	<input type="checkbox"/>	<input type="checkbox"/>	<input type="checkbox"/>				116.00#	1580	272	
	Wood Feet, Contrast	MPCR/WFT/FC	<input type="checkbox"/>	<input type="checkbox"/>	<input type="checkbox"/>	<input type="checkbox"/>	<input type="checkbox"/>	<input type="checkbox"/>			116.00#	1714	272	
	Aluminum Feet, Contrast	MPCR/AFT/FC	<input type="checkbox"/>	<input type="checkbox"/>	<input type="checkbox"/>	<input type="checkbox"/>	<input type="checkbox"/>	<input type="checkbox"/>	<input type="checkbox"/>		116.00#	1698	272	
			A	B	C	D	E	F	G	H	I			

HOW TO ORDER

Indicate the following information on order form:
 1. Quantity of each item.
 2. Model number, including options. See "How To Build a Model Number".
 3. Any special service required.

Note: • The indicates that a choice is required.
 • The absence of the indicates that no choice is required.
 • Alpha-numeric characters in place of indicate that no other alternatives are available.

HOW TO BUILD A MODEL NUMBER

- A** Select basic model.
- B** Non-contrast or fabric contrast 1
Refer to ki.com/fabrics.
• For yardage pricing, see Fabric Yardage Pricing page
- C** Select fabric contrast 2.
Refer to ki.com/fabrics
• For yardage pricing, see Fabric Yardage Pricing page
- D** Select power option.
RPT - Mini-Tap power module w/3-prong plug; add \$314
NP - No power
- E** Select Mini-Tap module w/3-prong plug location.
ICLF - Inside curve left facing power
OCLF - Outside curve left facing power
ICRF - Inside curve right facing power
OCRF - Outside curve right facing power
- F** Select module color.
MPB - Black power module
MPS - Silver power module
MPW - White power module
- G** Select wood feet finish.
Refer to the **Product Color Options** page in this price list.
- H** Select brushed aluminum feet finish.
Refer to the **Product Color Options** page in this price list.
- I** Select moisture barrier.
MB - Moisture barrier
NMB - No moisture barrier
See pricing column for moisture barrier upcharge.

SPECIAL SERVICES

Special Carton Marking

With specially marked information N/C

Shipping
Ships **assembled, FOB High Point, NC 27263, freight prepaid.** Freight class 250.

Specifications and prices are subject to change without prior notice.



Features	MODEL NUMBER										Approx. Packaged Weight	Delivered Pricing	Moisture Barrier add to list price	
	Basic Model	Non-Contrast or Fabric Contrast 1	Fabric Cont 2	Fabric Cont 3	Power Option	Power Location	Power Color	Wood Feet Finish	Alum-inum Feet Finish	Moist Barr				
concealed glides shown	Concealed Glide	MPSQRL/CGL/NC	<input type="checkbox"/>			<input type="checkbox"/>	<input type="checkbox"/>	<input type="checkbox"/>				62.00#	\$ 1247	\$ 216
	Poly Feet	MPSQRL/PFT/NC	<input type="checkbox"/>			<input type="checkbox"/>	<input type="checkbox"/>	<input type="checkbox"/>				62.00#	1247	216
	Wood Feet	MPSQRL/WFT/NC	<input type="checkbox"/>			<input type="checkbox"/>	<input type="checkbox"/>	<input type="checkbox"/>	<input type="checkbox"/>			62.00#	1379	216
	Casters	MPSQRL/CST/NC	<input type="checkbox"/>			<input type="checkbox"/>	<input type="checkbox"/>	<input type="checkbox"/>				62.00#	1247	216
	Aluminum Feet	MPSQRL/AFT/NC	<input type="checkbox"/>			<input type="checkbox"/>	<input type="checkbox"/>	<input type="checkbox"/>	<input type="checkbox"/>	<input type="checkbox"/>		62.00#	1366	216
MSQRL														
Lounge Chair, 32" Low-Back - Non-contrast														
<ul style="list-style-type: none"> • Non-contrast C.O.M = 3.5 yds • Ganging (specify kit separately) Overall Dimensions: <ul style="list-style-type: none"> • W=26" D=26" H=32" Seat Dimensions: <ul style="list-style-type: none"> • D=19" H=18" 														
concealed glides shown	Concealed Glide	MPSQRL/CGL/FC	<input type="checkbox"/>	<input type="checkbox"/>	<input type="checkbox"/>	<input type="checkbox"/>	<input type="checkbox"/>	<input type="checkbox"/>				62.00#	\$ 1268	\$ 216
	Poly Feet	MPSQRL/PFT/FC	<input type="checkbox"/>	<input type="checkbox"/>	<input type="checkbox"/>	<input type="checkbox"/>	<input type="checkbox"/>	<input type="checkbox"/>				62.00#	1268	216
	Wood Feet	MPSQRL/WFT/FC	<input type="checkbox"/>	<input type="checkbox"/>	<input type="checkbox"/>	<input type="checkbox"/>	<input type="checkbox"/>	<input type="checkbox"/>	<input type="checkbox"/>			62.00#	1404	216
	Casters	MPSQRL/CST/FC	<input type="checkbox"/>	<input type="checkbox"/>	<input type="checkbox"/>	<input type="checkbox"/>	<input type="checkbox"/>	<input type="checkbox"/>				62.00#	1268	216
	Aluminum Feet	MPSQRL/AFT/FC	<input type="checkbox"/>	<input type="checkbox"/>	<input type="checkbox"/>	<input type="checkbox"/>	<input type="checkbox"/>	<input type="checkbox"/>	<input type="checkbox"/>	<input type="checkbox"/>		62.00#	1366	216
MSQRL														
Lounge Chair, 32" Low-Back - Contrast														
<ul style="list-style-type: none"> • 1 = Base (Fabric Contrast 1) C.O.M. = 1.25 yd • 2 = Seat (Fabric Contrast 2) C.O.M. = .75 yd • 3 = Back (Fabric Contrast 3) C.O.M. = 1.75 yd • Ganging (specify kit separately) Overall Dimensions: <ul style="list-style-type: none"> • W=26" D=26" H=32" Seat Dimensions: <ul style="list-style-type: none"> • D=19" H=18" 														
A B C D E F G H I J														

HOW TO ORDER

Indicate the following information on order form:

- Quantity of each item.
- Model number, including options. See "How To Build a Model Number".
- Any special service required.

Note:

- The indicates that a choice is required.
- The absence of the indicates that no choice is required.
- Alpha-numeric characters in place of indicate that no other alternatives are available.

HOW TO BUILD A MODEL NUMBER

A Select basic model.

B Non-contrast or fabric contrast 1
Refer to ki.com/fabrics.
• For yardage pricing, see Fabric Yardage Pricing page

C Select fabric contrast 2.
Refer to ki.com/fabrics.
• For yardage pricing, see Fabric Yardage Pricing page

D Select fabric contrast 3.
Refer to ki.com/fabrics.
• For yardage pricing, see Fabric Yardage Pricing page

E Select power option.
RPT - Mini-Tap power module w/3-prong plug; add \$314
NP - No power

F Select Mini-Tap module w/3-prong plug

location.
LFP - Left-facing power
RFP - Right-facing power

G Select module color.
MPB - Black power module
MPS - Silver power module
MPW - White power module

H Select wood feet finish.
Refer to the **Product Color Options** page in this price list.

I Select brushed aluminum feet finish.
Refer to the **Product Color Options** page in this price list.

J Select moisture barrier.
MB - Moisture barrier
NMB - No moisture barrier
See pricing column for moisture barrier upcharge.

SPECIAL SERVICES

Special Carton Marking
With specially marked information N/C

Shipping
Ships assembled, FOB High Point, NC 27263, freight prepaid. Freight class 250.

Specifications and prices are subject to change without prior notice.

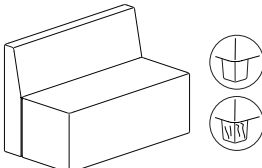
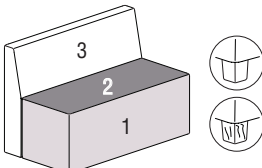

Features	MODEL NUMBER										Approx. Packaged Weight	Delivered Pricing	Moisture Barrier add to list price	
	Basic Model	Non-Cont or Fabric Cont 1	Fabric Cont 2	Fabric Cont 3	Pwr Opt	Pwr Loc	Pwr Color	Wd Feet Fin	Alum-inum Feet Finish	Moist Barr				
concealed glides shown 	Concealed Glide	MPRB/CGL/NC	<input type="checkbox"/>			<input type="checkbox"/>	<input type="checkbox"/>	<input type="checkbox"/>			<input type="checkbox"/>	91.00#	\$ 1600	\$ 292
	Poly Feet	MPRB/PFT/NC	<input type="checkbox"/>			<input type="checkbox"/>	<input type="checkbox"/>	<input type="checkbox"/>			<input type="checkbox"/>	91.00#	1600	292
	Wood Feet	MPRB/WFT/NC	<input type="checkbox"/>			<input type="checkbox"/>	<input type="checkbox"/>	<input type="checkbox"/>	<input type="checkbox"/>		<input type="checkbox"/>	91.00#	1730	292
	Aluminum Feet	MPRB/AFT/NC	<input type="checkbox"/>			<input type="checkbox"/>	<input type="checkbox"/>	<input type="checkbox"/>	<input type="checkbox"/>	<input type="checkbox"/>	<input type="checkbox"/>	91.00#	1730	292
MRB Rectangle with 32" Low-Back-Non-contrast <ul style="list-style-type: none"> • Non-contrast C.O.M = 4.75 yds • Ganging (specify kit separately) Overall Dimensions: <ul style="list-style-type: none"> • W=48" D=26" H=32" Seat Dimensions: <ul style="list-style-type: none"> • W=48" D=19" H=18" • Casters unavailable as standard. 														
concealed glides shown 	Concealed Glide	MPRB/CGL/FC	<input type="checkbox"/>	<input type="checkbox"/>	<input type="checkbox"/>	<input type="checkbox"/>	<input type="checkbox"/>	<input type="checkbox"/>			<input type="checkbox"/>	91.00#	\$ 1665	\$ 292
	Poly Feet	MPRB/PFT/FC	<input type="checkbox"/>	<input type="checkbox"/>	<input type="checkbox"/>	<input type="checkbox"/>	<input type="checkbox"/>	<input type="checkbox"/>			<input type="checkbox"/>	91.00#	1665	292
	Wood Feet	MPRB/WFT/FC	<input type="checkbox"/>	<input type="checkbox"/>	<input type="checkbox"/>	<input type="checkbox"/>	<input type="checkbox"/>	<input type="checkbox"/>	<input type="checkbox"/>		<input type="checkbox"/>	91.00#	1797	292
	Aluminum Feet	MPRB/AFT/FC	<input type="checkbox"/>	<input type="checkbox"/>	<input type="checkbox"/>	<input type="checkbox"/>	<input type="checkbox"/>	<input type="checkbox"/>	<input type="checkbox"/>	<input type="checkbox"/>	<input type="checkbox"/>	91.00#	1797	292
MRB Rectangle with 32" Low-Back- Contrast <ul style="list-style-type: none"> • 1 = Base (Fabric Contrast 1) C.O.M. = 2 yd • 2 = Seat (Fabric Contrast 2) C.O.M. = .75 yd • 3 = Back (Fabric Contrast 3) C.O.M. = 2.75 yd • Ganging (specify kit separately) Overall Dimensions: <ul style="list-style-type: none"> • W=48" D=26" H=32" Seat Dimensions: <ul style="list-style-type: none"> • W=48" D=19" H=18" • Casters unavailable as standard. 														

A B C D E F G H I J

HOW TO ORDER

- Indicate the following information on order form:
- Quantity of each item.
 - Model number, including options. See "How To Build a Model Number".
 - Any special service required.

Note: • The indicates that a choice is required.
 • The absence of the indicates that no choice is required.
 • Alpha-numeric characters in place of indicate that no other alternatives are available.

HOW TO BUILD A MODEL NUMBER

- A** Select basic model.
- B** Non-contrast or fabric contrast 1
Refer to ki.com/fabrics.
• For yardage pricing, see Fabric Yardage Pricing page
- C** Select fabric contrast 2.
Refer to ki.com/fabrics
• For yardage pricing, see Fabric Yardage Pricing page
- D** Select fabric contrast 3.
Refer to ki.com/fabrics
• For yardage pricing, see Fabric Yardage Pricing page
- E** Select power option.
RPT - Mini-Tap power module w/3-prong plug; add \$314
NP - No power
- F** Select Mini-Tap module w/3-prong plug location.

- LFP** - Left-facing power
- RFP** - Right-facing power
- G** Select module color.
MPB - Black power module
MPS - Silver power module
MPW - White power module
- H** Select wood feet finish.
Refer to the **Product Color Options** page in this price list.
- I** Select brushed aluminum feet finish.
Refer to the **Product Color Options** page in this price list.
- J** Select moisture barrier.
MB - Moisture barrier
NMB - No moisture barrier
See pricing column for moisture barrier upcharge.

SPECIAL SERVICES

Special Carton Marking

With specially marked information N/C

Shipping

Ships assembled, FOB High Point, NC 27263, freight prepaid. Freight class 250.

Specifications and prices are subject to change without prior notice.

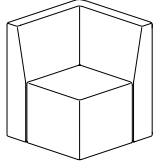
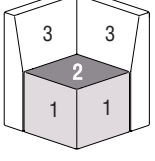

MODEL	Features	MODEL NUMBER									Approx. Packaged Weight	Delivered Pricing	Moisture Barrier add to list price						
		Basic Model	Non-Cont or Fabric Cont 1	Fabric Cont 2	Fabric Cont 3	Pwr Opt	Pwr Color	Wd Feet Fin	Alum-inum Feet Finish	Moist Barr									
concealed glides shown  MCRN	Corner LEFT with 32" Low-Back - Non-contrast • Non-contrast C.O.M = 4.25 yds • Ganging (specify kit separately) • Optional right-facing power Overall Dimensions: • W=26" D=26" H=32" Seat Dimensions: • W=19" D=19" H=18"	Concealed Glide	MPCRN/LF/CGL/NC	<input type="checkbox"/>														\$ 253	
		Poly Feet	MPCRN/LF/PFT/NC	<input type="checkbox"/>															253
		Wood Feet	MPCRN/LF/WFT/NC	<input type="checkbox"/>						<input type="checkbox"/>									253
		Casters	MPCRN/LF/CST/NC	<input type="checkbox"/>															253
		Aluminum Feet	MPCRN/LF/AFT/NC	<input type="checkbox"/>							<input type="checkbox"/>								253
concealed glides shown  MCRN	Corner LEFT with 32" Low-Back - Contrast • Ganging (specify kit separately) • Optional right-facing power • 1 = Base (Fabric Contrast 1) C.O.M. = 1.5 yd • 2 = Seat (Fabric Contrast 2) C.O.M. = .75 yd • 3 = Back (Fabric Contrast 3) C.O.M. = 2.5 yd • Price is based off of highest grade base or back fabric. Exclude seat fabric when selecting highest grade contrasting fabric.	Concealed Glide	MPCRN/LF/CGL/FC	<input type="checkbox"/>	<input type="checkbox"/>	<input type="checkbox"/>	<input type="checkbox"/>	<input type="checkbox"/>										\$ 253	
		Poly Feet	MPCRN/LF/PFT/FC	<input type="checkbox"/>	<input type="checkbox"/>	<input type="checkbox"/>	<input type="checkbox"/>	<input type="checkbox"/>											253
		Wood Feet	MPCRN/LF/WFT/FC	<input type="checkbox"/>	<input type="checkbox"/>	<input type="checkbox"/>	<input type="checkbox"/>	<input type="checkbox"/>	<input type="checkbox"/>										253
		Casters	MPCRN/LF/CST/FC	<input type="checkbox"/>	<input type="checkbox"/>	<input type="checkbox"/>	<input type="checkbox"/>	<input type="checkbox"/>											253
		Aluminum Feet	MPCRN/LF/AFT/FC	<input type="checkbox"/>	<input type="checkbox"/>	<input type="checkbox"/>	<input type="checkbox"/>	<input type="checkbox"/>		<input type="checkbox"/>									253
A B C D E F G H I																			

HOW TO ORDER
 Indicate the following information on order form:
 1. Quantity of each item.
 2. Model number, including options. See "How to Build a Model Number".
 3. Any special service required.

Note: • The indicates that a choice is required.
 • The absence of the indicates that no choice is required.
 • Alpha-numeric characters in place of indicate that no other alternatives are available.

HOW TO BUILD A MODEL NUMBER

A Select basic model.

B Non-contrast or fabric contrast 1
 Refer to ki.com/fabrics.
 • For yardage pricing, see Fabric Yardage Pricing page

C Select fabric contrast 2.
 Refer to ki.com/fabrics.
 • For yardage pricing, see Fabric Yardage Pricing page

D Select fabric contrast 3.
 Refer to ki.com/fabrics.
 • For yardage pricing, see Fabric Yardage Pricing page

E Select power option.
RPT - Mini-Tap power module w/3-prong plug; add \$314
NP - No power

F Select module color.

G Select wood feet finish.
 Refer to the **Product Color Options** page in this price list.

H Select brushed aluminum feet finish.
 Refer to the **Product Color Options** page in this price list.

I Select moisture barrier.
MB - Moisture barrier
NMB - No moisture barrier
 See pricing column for moisture barrier upcharge.

MPB - Black power module
MPS - Silver power module
MPW - White power module

SPECIAL SERVICES
Special Carton Marking
 With specially marked information N/C

Shipping
 Ships assembled, FOB High Point, NC 27263, freight prepaid. Freight class 250.

Specifications and prices are subject to change without prior notice.

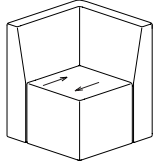
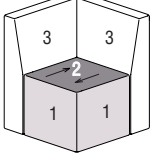

MODEL	Features	MODEL NUMBER								Approx. Packaged Weight	Delivered Pricing	Moisture Barrier add to list price	
		Basic Model	Non-Cont or Fabric Cont 1	Fabric Cont 2	Fabric Cont 3	Pwr Opt	Pwr Color	Wd Feet Fin	Alum-inum Feet Finish				Moist Barr
concealed glides shown  Corner RIGHT with 32" Low-Back - Non-contrast • Non-contrast C.O.M = 4.25 yds • Ganging (specify kit separately) • Optional left-facing power Overall Dimensions: • W=26" D=26" H=32" Seat Dimensions: • W=19" D=19" H=18"	Concealed Glide	MPCRN/RF/CGL/NC	<input type="checkbox"/>				<input type="checkbox"/>	<input type="checkbox"/>			50.00#	\$ 1551	\$ 253
	Poly Feet	MPCRN/RF/PFT/NC	<input type="checkbox"/>				<input type="checkbox"/>	<input type="checkbox"/>			50.00#	1551	253
	Wood Feet	MPCRN/RF/WFT/NC	<input type="checkbox"/>				<input type="checkbox"/>	<input type="checkbox"/>	<input type="checkbox"/>		50.00#	1681	253
	Casters	MPCRN/RF/CST/NC	<input type="checkbox"/>				<input type="checkbox"/>	<input type="checkbox"/>			50.00#	1551	253
	Aluminum Feet	MPCRN/RF/AFT/NC	<input type="checkbox"/>				<input type="checkbox"/>	<input type="checkbox"/>	<input type="checkbox"/>	<input type="checkbox"/>	50.00#	1681	253
concealed glides shown  Corner RIGHT with 32" Low-Back - Contrast • Ganging (specify kit separately) • Optional left-facing power • 1 = Base (Fabric Contrast 1) C.O.M. = 1.5 yd • 2 = Seat (Fabric Contrast 2) C.O.M. = .75 yd • 3 = Back (Fabric Contrast 3) C.O.M. = 2.5 yd	Concealed Glide	MPCRN/RF/CGL/FC	<input type="checkbox"/>	<input type="checkbox"/>	<input type="checkbox"/>	<input type="checkbox"/>	<input type="checkbox"/>				50.00#	\$ 1618	\$ 253
	Poly Feet	MPCRN/RF/PFT/FC	<input type="checkbox"/>	<input type="checkbox"/>	<input type="checkbox"/>	<input type="checkbox"/>	<input type="checkbox"/>				50.00#	1618	253
	Wood Feet	MPCRN/RF/WFT/FC	<input type="checkbox"/>	<input type="checkbox"/>	<input type="checkbox"/>	<input type="checkbox"/>	<input type="checkbox"/>	<input type="checkbox"/>			50.00#	1748	253
	Casters	MPCRN/RF/CST/FC	<input type="checkbox"/>	<input type="checkbox"/>	<input type="checkbox"/>	<input type="checkbox"/>	<input type="checkbox"/>				50.00#	1618	253
	Aluminum Feet	MPCRN/RF/AFT/FC	<input type="checkbox"/>	<input type="checkbox"/>	<input type="checkbox"/>	<input type="checkbox"/>	<input type="checkbox"/>	<input type="checkbox"/>	<input type="checkbox"/>	<input type="checkbox"/>	50.00#	1748	253
			A	B	C	D	E	F	G	H	I		

HOW TO ORDER

- Indicate the following information on order form:
- Quantity of each item.
 - Model number, including options. See "How to Build a Model Number".
 - Any special service required.

Note: • The indicates that a choice is required.
 • The absence of the indicates that no choice is required.
 • Alpha-numeric characters in place of indicate that no other alternatives are available.

HOW TO BUILD A MODEL NUMBER

- A** Select basic model.
- B** Non-contrast or fabric contrast 1
Refer to ki.com/fabrics.
• For yardage pricing, see Fabric Yardage Pricing page
- C** Select fabric contrast 2.
Refer to ki.com/fabrics
• For yardage pricing, see Fabric Yardage Pricing page
- D** Select fabric contrast 3.
Refer to ki.com/fabrics
• For yardage pricing, see Fabric Yardage Pricing page
- E** Select power option.
RPT - Mini-Tap power module w/3-prong plug; add \$314
NP - No power
- F** Select module color.
- G** Select wood feet finish.
Refer to the **Product Color Options** page in this price list.
- H** Select brushed aluminum feet finish.
Refer to the **Product Color Options** page in this price list.
- I** Select moisture barrier.
MB - Moisture barrier
NMB - No moisture barrier
See pricing column for moisture barrier upcharge.

- MPB** - Black power module
- MPS** - Silver power module
- MPW** - White power module

SPECIAL SERVICES

Special Carton Marking

With specially marked information N/C

Shipping

Ships assembled, FOB High Point, NC 27263, freight prepaid. Freight class 250.

Specifications and prices are subject to change without prior notice.

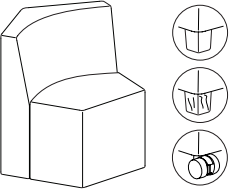
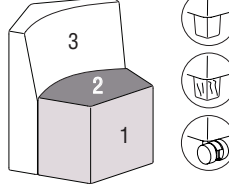

Features	MODEL NUMBER										Approx. Packaged Weight	Delivered Pricing	Moisture Barrier add to list price		
	Basic Model	Non-Cont or Fabric Cont 1	Fabric Cont 2	Fabric Cont 3	Pwr Opt	Pwr Loc	Pwr Color	Wd Feet Fin	Alum-inum Feet Finish	Moist Barr					
concealed glides shown 	Concealed Glide	MP5S/CGL/NC	<input type="checkbox"/>										67.00#	\$ 1520	\$ 243
	Poly Feet	MP5S/PFT/NC	<input type="checkbox"/>										67.00#	1520	243
	Wood Feet	MP5S/WFT/NC	<input type="checkbox"/>					<input type="checkbox"/>					67.00#	1651	243
	Casters	MP5S/CST/NC	<input type="checkbox"/>										67.00#	1520	243
	Aluminum Feet	MP5S/AFT/NC	<input type="checkbox"/>						<input type="checkbox"/>				67.00#	1651	243
M5S Five Star with 32" Low-Back - Non-contrast															
<ul style="list-style-type: none"> • Non-contrast C.O.M = 3.75 yds • Ganging (specify kit separately). Five Star models can only gang to other Five Star models 															
Overall Dimensions:															
• W=31-1/4" D=20" H=32"															
Seat Dimensions:															
• W=19" D=17" H=18"															
concealed glides shown 	Concealed Glide	MP5S/CGL/FC	<input type="checkbox"/>	<input type="checkbox"/>	<input type="checkbox"/>	<input type="checkbox"/>	<input type="checkbox"/>	<input type="checkbox"/>					67.00#	\$ 1585	\$ 243
	Poly Feet	MP5S/PFT/FC	<input type="checkbox"/>	<input type="checkbox"/>	<input type="checkbox"/>	<input type="checkbox"/>	<input type="checkbox"/>	<input type="checkbox"/>					67.00#	1585	243
	Wood Feet	MP5S/WFT/FC	<input type="checkbox"/>	<input type="checkbox"/>	<input type="checkbox"/>	<input type="checkbox"/>	<input type="checkbox"/>	<input type="checkbox"/>	<input type="checkbox"/>				67.00#	1717	243
	Casters	MP5S/CST/FC	<input type="checkbox"/>	<input type="checkbox"/>	<input type="checkbox"/>	<input type="checkbox"/>	<input type="checkbox"/>	<input type="checkbox"/>					67.00#	1585	243
	Aluminum Feet	MP5S/AFT/FC	<input type="checkbox"/>	<input type="checkbox"/>	<input type="checkbox"/>	<input type="checkbox"/>	<input type="checkbox"/>		<input type="checkbox"/>				67.00#	1717	243
M5S Five Star with 32" Low-Back- Contrast															
<ul style="list-style-type: none"> • 1 = Base (Fabric Contrast 1) C.O.M. = 1.5 yd • 2 = Seat (Fabric Contrast 2) C.O.M. = .75 yd • 3 = Back (Fabric Contrast 3) C.O.M. = 2 yd • Ganging (specify kit separately). Five Star models can only gang to other Five Star models. 															

A B C D E F G H I J

HOW TO ORDER

- Indicate the following information on order form:
- Quantity of each item.
 - Model number, including options. See "How To Build a Model Number".
 - Any special service required.

Note: • The indicates that a choice is required.
• The absence of the indicates that no choice is required.
• Alpha-numeric characters in place of indicate that no other alternatives are available.

HOW TO BUILD A MODEL NUMBER

- A** Select basic model.
- B** Non-contrast or fabric contrast 1
Refer to ki.com/fabrics.
• For yardage pricing, see Fabric Yardage Pricing page
- C** Select fabric contrast 2.
Refer to ki.com/fabrics
• For yardage pricing, see Fabric Yardage Pricing page
- D** Select fabric contrast 3.
Refer to ki.com/fabrics
• For yardage pricing, see Fabric Yardage Pricing page
- E** Select power option.
RPT - Mini-Tap power module w/3-prong plug; add \$314
NP - No power
- F** Select Mini-Tap module w/3-prong plug location.

- LFP** - Left-facing power
- RFP** - Right-facing power

- G** Select module color.
MPB - Black power module
MPS - Silver power module
MPW - White power module

- H** Select wood feet finish.
Refer to the **Product Color Options** page in this price list.

- I** Select brushed aluminum feet finish.
Refer to the **Product Color Options** page in this price list.

- J** Select moisture barrier.
MB - Moisture barrier
NMB - No moisture barrier
See pricing column for moisture barrier upcharge.

SPECIAL SERVICES

Special Carton Marking

With specially marked information N/C

Shipping

Ships assembled, FOB High Point, NC 27263, freight prepaid. Freight class 250.

Specifications and prices are subject to change without prior notice.



Features	MODEL NUMBER										Approx. Packaged Weight	Delivered Pricing	Moisture Barrier add to list price	
	Basic Model	Non-Cont or Fabric Cont 1	Fabric Cont 2	Fabric Cont 3	Pwr Opt	Pwr Loc	Pwr Color	Wd Feet Fin	Alum-inum Feet Finish	Moist Barr				
concealed glides shown	Concealed Glide	MPC130/CGL/NC	<input type="checkbox"/>			<input type="checkbox"/>	<input type="checkbox"/>	<input type="checkbox"/>			<input type="checkbox"/>	64.00#	\$ 1224	\$ 210
	Poly Feet	MPC130/PFT/NC	<input type="checkbox"/>			<input type="checkbox"/>	<input type="checkbox"/>	<input type="checkbox"/>			<input type="checkbox"/>	61.00#	1224	210
	Wood Feet	MPC130/WFT/NC	<input type="checkbox"/>			<input type="checkbox"/>	<input type="checkbox"/>	<input type="checkbox"/>	<input type="checkbox"/>		<input type="checkbox"/>	61.00#	1356	210
	Casters	MPC130/CST/NC	<input type="checkbox"/>			<input type="checkbox"/>	<input type="checkbox"/>	<input type="checkbox"/>			<input type="checkbox"/>	61.00#	1224	210
	Aluminum Feet	MPC130/AFT/NC	<input type="checkbox"/>			<input type="checkbox"/>	<input type="checkbox"/>	<input type="checkbox"/>		<input type="checkbox"/>	<input type="checkbox"/>	51.50#	1344	210
MCI30														
Inside Back, 30° Curve, 32" Low-Back - Non-contrast														
<ul style="list-style-type: none"> • Non-contrast C.O.M = 2.75 yds • Ganging (specify kit separately) Overall Dimensions: <ul style="list-style-type: none"> • W=28" D=26" H=32" Seat Dimensions: <ul style="list-style-type: none"> • D=19" H=18" 														
concealed glides shown	Concealed Glide	MPC130/CGL/FC	<input type="checkbox"/>	<input type="checkbox"/>	<input type="checkbox"/>	<input type="checkbox"/>	<input type="checkbox"/>	<input type="checkbox"/>			<input type="checkbox"/>	64.00#	\$ 1247	\$ 210
	Poly Feet	MPC130/PFT/FC	<input type="checkbox"/>	<input type="checkbox"/>	<input type="checkbox"/>	<input type="checkbox"/>	<input type="checkbox"/>	<input type="checkbox"/>			<input type="checkbox"/>	61.00#	1247	210
	Wood Feet	MPC130/WFT/FC	<input type="checkbox"/>	<input type="checkbox"/>	<input type="checkbox"/>	<input type="checkbox"/>	<input type="checkbox"/>	<input type="checkbox"/>	<input type="checkbox"/>		<input type="checkbox"/>	61.00#	1381	210
	Casters	MPC130/CST/FC	<input type="checkbox"/>	<input type="checkbox"/>	<input type="checkbox"/>	<input type="checkbox"/>	<input type="checkbox"/>	<input type="checkbox"/>			<input type="checkbox"/>	61.00#	1247	210
	Aluminum Feet	MPC130/AFT/FC	<input type="checkbox"/>	<input type="checkbox"/>	<input type="checkbox"/>	<input type="checkbox"/>	<input type="checkbox"/>	<input type="checkbox"/>		<input type="checkbox"/>	<input type="checkbox"/>	64.00#	1344	210
MCI30														
Inside Back, 30° Curve, 32" Low-Back - Contrast														
<ul style="list-style-type: none"> • 1 = Base (Fabric Contrast 1) C.O.M. = 1.25 yd • 2 = Seat (Fabric Contrast 2) C.O.M. = .75 yd • 3 = Back (Fabric Contrast 3) C.O.M. = 2 yd • Ganging (specify kit separately) Overall Dimensions: <ul style="list-style-type: none"> • W=28" D=26" H=32" Seat Dimensions: <ul style="list-style-type: none"> • D=19" H=18" 														

A B C D E F G H I J

HOW TO ORDER

- Indicate the following information on order form:
1. Quantity of each item.
 2. Model number, including options. See "How To Build a Model Number".
 3. Any special service required.

Note: • The indicates that a choice is required.
 • The absence of the indicates that no choice is required.
 • Alpha-numeric characters in place of indicate that no other alternatives are available.

HOW TO BUILD A MODEL NUMBER

- A** Select basic model.
- B** Non-contrast or fabric contrast 1
Refer to ki.com/fabrics.
• For yardage pricing, see Fabric Yardage Pricing page
- C** Select fabric contrast 2.
Refer to ki.com/fabrics.
• For yardage pricing, see Fabric Yardage Pricing page
- D** Select fabric contrast 3.
Refer to ki.com/fabrics.
• For yardage pricing, see Fabric Yardage Pricing page
- E** Select power option.
RPT - Mini-Tap power module w/3-prong plug; add \$314
NP - No power
- F** Select Mini-Tap module w/3-prong plug location.
LFP - Left-facing power
RFP - Right-facing power
- G** Select module color.
MPB - Black power module
MPS - Silver power module
MPW - White power module
- H** Select wood feet finish.
Refer to the **Product Color Options** page in this price list.
- I** Select brushed aluminum feet finish.
Refer to the **Product Color Options** page in this price list.
- J** Select moisture barrier.
MB - Moisture barrier
NMB - No moisture barrier
See pricing column for moisture barrier upcharge.

SPECIAL SERVICES

Special Carton Marking
With specially marked information N/C

Shipping
Ships assembled, FOB High Point, NC 27263, freight prepaid. Freight class 250.

Specifications and prices are subject to change without prior notice.



Features	MODEL NUMBER											Approx. Packaged Weight	Delivered Pricing	Moisture Barrier add to list price		
	Basic Model	Non-Cont or Fabric Cont 1	Fabric Cont 2	Fabric Cont 3	Pwr Opt	Pwr Loc	Pwr Color	Wd Feet Fin	Alum-inum Feet Finish	Moist Barr						
concealed glides shown	Concealed Glide	MPC030/CGL/NC	<input type="checkbox"/>			<input type="checkbox"/>	<input type="checkbox"/>	<input type="checkbox"/>						58.00#	\$ 1144	\$ 203
	Poly Feet	MPC030/PFT/NC	<input type="checkbox"/>			<input type="checkbox"/>	<input type="checkbox"/>	<input type="checkbox"/>						56.00#	1144	203
	Wood Feet	MPC030/WFT/NC	<input type="checkbox"/>			<input type="checkbox"/>	<input type="checkbox"/>	<input type="checkbox"/>	<input type="checkbox"/>					56.00#	1275	203
	Casters	MPC030/CST/NC	<input type="checkbox"/>			<input type="checkbox"/>	<input type="checkbox"/>	<input type="checkbox"/>						56.00#	1144	203
	Aluminum Feet	MPC030/AFT/NC	<input type="checkbox"/>			<input type="checkbox"/>	<input type="checkbox"/>	<input type="checkbox"/>		<input type="checkbox"/>	<input type="checkbox"/>			58.00#	1264	203
MCO30																
Outside Back, 30° Curve, 32" Low-Back - Non-contrast																
<ul style="list-style-type: none"> • Non-contrast C.O.M = 2.50 yds • Ganging (specify kit separately) Overall Dimensions: <ul style="list-style-type: none"> • W=28" D=26" H=32" Seat Dimensions: <ul style="list-style-type: none"> • D=19" H=18" 																
concealed glides shown	Concealed Glide	MPC030/CGL/FC	<input type="checkbox"/>	<input type="checkbox"/>	<input type="checkbox"/>	<input type="checkbox"/>	<input type="checkbox"/>	<input type="checkbox"/>						58.00#	\$ 1164	\$ 203
	Poly Feet	MPC030/PFT/FC	<input type="checkbox"/>	<input type="checkbox"/>	<input type="checkbox"/>	<input type="checkbox"/>	<input type="checkbox"/>	<input type="checkbox"/>						56.00#	1164	203
	Wood Feet	MPC030/WFT/FC	<input type="checkbox"/>	<input type="checkbox"/>	<input type="checkbox"/>	<input type="checkbox"/>	<input type="checkbox"/>	<input type="checkbox"/>	<input type="checkbox"/>					56.00#	1299	203
	Casters	MPC030/CST/FC	<input type="checkbox"/>	<input type="checkbox"/>	<input type="checkbox"/>	<input type="checkbox"/>	<input type="checkbox"/>	<input type="checkbox"/>						56.00#	1164	203
	Aluminum Feet	MPC030/AFT/FC	<input type="checkbox"/>	<input type="checkbox"/>	<input type="checkbox"/>	<input type="checkbox"/>	<input type="checkbox"/>	<input type="checkbox"/>		<input type="checkbox"/>	<input type="checkbox"/>			58.00#	1264	203
MCO30																
Outside Back, 30° Curve, 32" Low-Back - Contrast																
<ul style="list-style-type: none"> • 1 = Base (Fabric Contrast 1) C.O.M. = 1.25 yd • 2 = Seat (Fabric Contrast 2) C.O.M. = .75 yd • 3 = Back (Fabric Contrast 3) C.O.M. = 1.25 yd • Ganging (specify kit separately) Overall Dimensions: <ul style="list-style-type: none"> • W=28" D=26" H=32" Seat Dimensions: <ul style="list-style-type: none"> • D=19" H=18" 																
A B C D E F G H I J																

HOW TO ORDER

Indicate the following information on order form:

- Quantity of each item.
- Model number, including options. See "How To Build a Model Number".
- Any special service required.

Note:

- The indicates that a choice is required.
- The absence of the indicates that no choice is required.
- Alpha-numeric characters in place of indicate that no other alternatives are available.

HOW TO BUILD A MODEL NUMBER

A Select basic model.

B Non-contrast or fabric contrast 1
Refer to ki.com/fabrics.
• For yardage pricing, see Fabric Yardage Pricing page

C Select fabric contrast 2.
Refer to ki.com/fabrics.
• For yardage pricing, see Fabric Yardage Pricing page

D Select fabric contrast 3.
Refer to ki.com/fabrics.
• For yardage pricing, see Fabric Yardage Pricing page

E Select power option.
RPT - Mini-Tap power module w/3-prong plug; add \$314
NP - No power

F Select Mini-Tap module w/3-prong plug location.

LFP - Left-facing power
RFP - Right-facing power

G Select module color.
MPB - Black power module
MPS - Silver power module
MPW - White power module

H Select wood feet finish.
Refer to the **Product Color Options** page in this price list.

I Select brushed aluminum feet finish.
Refer to the **Product Color Options** page in this price list.

J Select moisture barrier.
MB - Moisture barrier
NMB - No moisture barrier
See pricing column for moisture barrier upcharge.

SPECIAL SERVICES

Special Carton Marking
With specially marked information N/C

Shipping
Ships assembled, FOB High Point, NC 27263, freight prepaid. Freight class 250.

Specifications and prices are subject to change without prior notice.



Features	MODEL NUMBER										Approx. Packaged Weight	Delivered Pricing	Moisture Barrier add to list price	
	Basic Model	Non-Cont or Fabric Cont 1	Fabric Cont 2	Fabric Cont 3	Pwr Opt	Pwr Loc	Pwr Color	Wd Feet Fin	Alum-inum Feet Finish	Moist Barr				
concealed glides shown	Concealed Glide	MPC145/CGL/NC	<input type="checkbox"/>			<input type="checkbox"/>	<input type="checkbox"/>	<input type="checkbox"/>			<input type="checkbox"/>	84.00#	\$ 1696	\$ 227
	Poly Feet	MPC145/PFT/NC	<input type="checkbox"/>			<input type="checkbox"/>	<input type="checkbox"/>	<input type="checkbox"/>			<input type="checkbox"/>	82.00#	1696	227
	Wood Feet	MPC145/WFT/NC	<input type="checkbox"/>			<input type="checkbox"/>	<input type="checkbox"/>	<input type="checkbox"/>	<input type="checkbox"/>		<input type="checkbox"/>	82.00#	1829	227
	Casters	MPC145/CST/NC	<input type="checkbox"/>			<input type="checkbox"/>	<input type="checkbox"/>	<input type="checkbox"/>			<input type="checkbox"/>	82.00#	1696	227
	Aluminum Feet	MPC145/AFT/NC	<input type="checkbox"/>			<input type="checkbox"/>	<input type="checkbox"/>	<input type="checkbox"/>		<input type="checkbox"/>	<input type="checkbox"/>	82.00#	1813	227
MCI45														
Inside Back, 45° Curve, 32" Low-Back - Non-contrast														
<ul style="list-style-type: none"> • Non-contrast C.O.M = 3.75 yds • Ganging (specify kit separately) Overall Dimensions: <ul style="list-style-type: none"> • W=41.5" D=26" H=32" Seat Dimensions: <ul style="list-style-type: none"> • D=19" H=18" 														
concealed glides shown	Concealed Glide	MPC145/CGL/FC	<input type="checkbox"/>	<input type="checkbox"/>	<input type="checkbox"/>	<input type="checkbox"/>	<input type="checkbox"/>	<input type="checkbox"/>			<input type="checkbox"/>	84.00#	\$ 1727	\$ 227
	Poly Feet	MPC145/PFT/FC	<input type="checkbox"/>	<input type="checkbox"/>	<input type="checkbox"/>	<input type="checkbox"/>	<input type="checkbox"/>	<input type="checkbox"/>			<input type="checkbox"/>	82.00#	1727	227
	Wood Feet	MPC145/WFT/FC	<input type="checkbox"/>	<input type="checkbox"/>	<input type="checkbox"/>	<input type="checkbox"/>	<input type="checkbox"/>	<input type="checkbox"/>	<input type="checkbox"/>		<input type="checkbox"/>	82.00#	1862	227
	Casters	MPC145/CST/FC	<input type="checkbox"/>	<input type="checkbox"/>	<input type="checkbox"/>	<input type="checkbox"/>	<input type="checkbox"/>	<input type="checkbox"/>			<input type="checkbox"/>	82.00#	1727	227
	Aluminum Feet	MPC145/AFT/FC	<input type="checkbox"/>	<input type="checkbox"/>	<input type="checkbox"/>	<input type="checkbox"/>	<input type="checkbox"/>	<input type="checkbox"/>		<input type="checkbox"/>	<input type="checkbox"/>	82.00#	1813	227
MCI45														
Inside Back, 45° Curve, 32" Low-Back - Contrast														
<ul style="list-style-type: none"> • 1 = Base (Fabric Contrast 1) C.O.M. = 1.75 yd • 2 = Seat (Fabric Contrast 2) C.O.M. = .75 yd • 3 = Back (Fabric Contrast 3) C.O.M. = 2 yd • Ganging (specify kit separately) Overall Dimensions: <ul style="list-style-type: none"> • W=41.5" D=26" H=32" Seat Dimensions: <ul style="list-style-type: none"> • D=19" H=18" 														

A B C D E F G H I J

HOW TO ORDER

Indicate the following information on order form:
 1. Quantity of each item.
 2. Model number, including options. See "How To Build a Model Number".
 3. Any special service required.

Note: • The indicates that a choice is required.
 • The absence of the indicates that no choice is required.
 • Alpha-numeric characters in place of indicate that no other alternatives are available.

HOW TO BUILD A MODEL NUMBER

- A** Select basic model.
- B** Non-contrast or fabric contrast 1
Refer to ki.com/fabrics.
• For yardage pricing, see Fabric Yardage Pricing page
- C** Select fabric contrast 2.
Refer to ki.com/fabrics.
• For yardage pricing, see Fabric Yardage Pricing page
- D** Select fabric contrast 3.
Refer to ki.com/fabrics.
• For yardage pricing, see Fabric Yardage Pricing page
- E** Select power option.
RPT - Mini-Tap power module w/3-prong plug; add \$314
NP - No power
- F** Select Mini-Tap module w/3-prong plug

- location.
LFP - Left-facing power
RFP - Right-facing power
- G** Select module color.
MPB - Black power module
MPS - Silver power module
MPW - White power module
- H** Select wood feet finish.
Refer to the **Product Color Options** page in this price list.
- I** Select brushed aluminum feet finish.
Refer to the **Product Color Options** page in this price list.
- J** Select moisture barrier.
MB - Moisture barrier
NMB - No moisture barrier
See pricing column for moisture barrier upcharge.

SPECIAL SERVICES

Special Carton Marking
With specially marked information N/C

Shipping
Ships assembled, FOB High Point, NC 27263, freight prepaid. Freight class 250.

Specifications and prices are subject to change without prior notice.



Features	MODEL NUMBER											Approx. Packaged Weight	Delivered Pricing	Moisture Barrier add to list price
	Basic Model	Non-Cont or Fabric Cont 1	Fabric Cont 2	Fabric Cont 3	Pwr Opt	Pwr Loc	Pwr Color	Wd Feet Fin	Alum-inum Feet Finish	Moist Barr				
concealed glides shown 	Concealed Glide	MPC045/CGL/NC	<input type="checkbox"/>			<input type="checkbox"/>	<input type="checkbox"/>	<input type="checkbox"/>			<input type="checkbox"/>	67.00#	\$ 1584	\$ 223
	Poly Feet	MPC045/PFT/NC	<input type="checkbox"/>			<input type="checkbox"/>	<input type="checkbox"/>	<input type="checkbox"/>			<input type="checkbox"/>	65.50#	1584	223
	Wood Feet	MPC045/WFT/NC	<input type="checkbox"/>			<input type="checkbox"/>	<input type="checkbox"/>	<input type="checkbox"/>	<input type="checkbox"/>		<input type="checkbox"/>	65.50#	1716	223
	Casters	MPC045/CST/NC	<input type="checkbox"/>			<input type="checkbox"/>	<input type="checkbox"/>	<input type="checkbox"/>			<input type="checkbox"/>	65.50#	1584	223
	Aluminum Feet	MPC045/AFT/NC	<input type="checkbox"/>			<input type="checkbox"/>	<input type="checkbox"/>	<input type="checkbox"/>		<input type="checkbox"/>	<input type="checkbox"/>	66.50#	1702	223
MCO45 Outside Back, 45° Curve, 32" Low-Back - Non-contrast • Non-contrast C.O.M = 3.25 yds • Ganging (specify kit separately) Overall Dimensions: • W=41.5" D=26" H=32" Seat Dimensions: • D=19" H=18"														
concealed glides shown 	Concealed Glide	MPC045/CGL/FC	<input type="checkbox"/>	<input type="checkbox"/>	<input type="checkbox"/>	<input type="checkbox"/>	<input type="checkbox"/>	<input type="checkbox"/>			<input type="checkbox"/>	67.00#	\$ 1612	\$ 223
	Poly Feet	MPC045/PFT/FC	<input type="checkbox"/>	<input type="checkbox"/>	<input type="checkbox"/>	<input type="checkbox"/>	<input type="checkbox"/>	<input type="checkbox"/>			<input type="checkbox"/>	65.50#	1612	223
	Wood Feet	MPC045/WFT/FC	<input type="checkbox"/>	<input type="checkbox"/>	<input type="checkbox"/>	<input type="checkbox"/>	<input type="checkbox"/>	<input type="checkbox"/>	<input type="checkbox"/>		<input type="checkbox"/>	65.50#	1815	223
	Casters	MPC045/CST/FC	<input type="checkbox"/>	<input type="checkbox"/>	<input type="checkbox"/>	<input type="checkbox"/>	<input type="checkbox"/>	<input type="checkbox"/>			<input type="checkbox"/>	53.50#	1612	223
	Aluminum Feet	MPC045/AFT/FC	<input type="checkbox"/>	<input type="checkbox"/>	<input type="checkbox"/>	<input type="checkbox"/>	<input type="checkbox"/>	<input type="checkbox"/>		<input type="checkbox"/>	<input type="checkbox"/>	66.50#	1702	223
MCO45 Outside Back, 45° Curve, 32" Low-Back - Contrast • 1 = Base (Fabric Contrast 1) C.O.M. = 1.75 yd • 2 = Seat (Fabric Contrast 2) C.O.M. = 1 yd • 3 = Back (Fabric Contrast 3) C.O.M. = 1.75 yd • Ganging (specify kit separately) Overall Dimensions: • W=41.5" D=26" H=32" Seat Dimensions: • D=19" H=18"														
A B C D E F G H I J														

HOW TO ORDER

- Indicate the following information on order form:
- Quantity of each item.
 - Model number, including options. See "How To Build a Model Number".
 - Any special service required.

Note: • The indicates that a choice is required.
 • The absence of the indicates that no choice is required.
 • Alpha-numeric characters in place of indicate that no other alternatives are available.

HOW TO BUILD A MODEL NUMBER

- A** Select basic model.
- B** Non-contrast or fabric contrast 1
Refer to ki.com/fabrics.
• For yardage pricing, see Fabric Yardage Pricing page
- C** Select fabric contrast 2.
Refer to ki.com/fabrics.
• For yardage pricing, see Fabric Yardage Pricing page
- D** Select fabric contrast 3.
Refer to ki.com/fabrics.
• For yardage pricing, see Fabric Yardage Pricing page
- E** Select power option.
RPT - Mini-Tap power module w/3-prong plug; add \$314
NP - No power
- F** Select Mini-Tap module w/3-prong plug

- location.
LFP - Left-facing power
RFP - Right-facing power
- G** Select module color.
MPB - Black power module
MPS - Silver power module
MPW - White power module
- H** Select wood feet finish.
Refer to the **Product Color Options** page in this price list.
- I** Select brushed aluminum feet finish.
Refer to the **Product Color Options** page in this price list.
- J** Select moisture barrier.
MB - Moisture barrier
NMB - No moisture barrier
See pricing column for moisture barrier upcharge.

SPECIAL SERVICES

Special Carton Marking

With specially marked information N/C

Shipping

Ships assembled, FOB High Point, NC 27263, freight prepaid. Freight class 250.

Specifications and prices are subject to change without prior notice.



Features	MODEL NUMBER										Approx. Packaged Weight	Delivered Pricing	Moisture Barrier add to list price	
	Basic Model	Non-Cont or Fabric Cont 1	Fabric Cont 2	Fabric Cont 3	Pwr Opt	Pwr Loc	Pwr Color	Wd Feet Fin	Alum-inum Feet Finish	Moist Barr				
concealed glides shown	Concealed Glide	MPCI60/CGL/NC	<input type="checkbox"/>			<input type="checkbox"/>	<input type="checkbox"/>	<input type="checkbox"/>			<input type="checkbox"/>	98.00#	\$ 1945	\$ 240
	Poly Feet	MPCI60/PFT/NC	<input type="checkbox"/>			<input type="checkbox"/>	<input type="checkbox"/>	<input type="checkbox"/>			<input type="checkbox"/>	95.00#	1945	240
	Wood Feet	MPCI60/WFT/NC	<input type="checkbox"/>			<input type="checkbox"/>	<input type="checkbox"/>	<input type="checkbox"/>	<input type="checkbox"/>		<input type="checkbox"/>	95.00#	2077	240
	Aluminum Feet	MPCI60/AFT/NC	<input type="checkbox"/>			<input type="checkbox"/>	<input type="checkbox"/>	<input type="checkbox"/>		<input type="checkbox"/>	<input type="checkbox"/>	95.00#	2059	240
MCI60 Inside Back, 60° Curve, 32" Low-Back - Non-contrast • Non-contrast C.O.M = 4.75 yds • Ganging (specify kit separately) Overall Dimensions: • W=54" D=26" H=32" Seat Dimensions: • D=19" H=18" • Casters unavailable as standard.														
concealed glides shown	Concealed Glide	MPCI60/CGL/FC	<input type="checkbox"/>	<input type="checkbox"/>	<input type="checkbox"/>	<input type="checkbox"/>	<input type="checkbox"/>	<input type="checkbox"/>			<input type="checkbox"/>	98.00#	\$ 1979	\$ 240
	Poly Feet	MPCI60/PFT/FC	<input type="checkbox"/>	<input type="checkbox"/>	<input type="checkbox"/>	<input type="checkbox"/>	<input type="checkbox"/>	<input type="checkbox"/>			<input type="checkbox"/>	95.00#	1979	240
	Wood Feet	MPCI60/WFT/FC	<input type="checkbox"/>	<input type="checkbox"/>	<input type="checkbox"/>	<input type="checkbox"/>	<input type="checkbox"/>	<input type="checkbox"/>	<input type="checkbox"/>		<input type="checkbox"/>	95.00#	2115	240
	Aluminum Feet	MPCI60/AFT/FC	<input type="checkbox"/>	<input type="checkbox"/>	<input type="checkbox"/>	<input type="checkbox"/>	<input type="checkbox"/>	<input type="checkbox"/>		<input type="checkbox"/>	<input type="checkbox"/>	95.00#	2059	240
MCI60 Inside Back, 60° Curve, 32" Low-Back - Contrast • 1 = Base (Fabric Contrast 1) C.O.M. = 1.75 yd • 2 = Seat (Fabric Contrast 2) C.O.M. = .75 yd • 3 = Back (Fabric Contrast 3) C.O.M. = 3.25 yd • Ganging (specify kit separately) Overall Dimensions: • W=54" D=26" H=32" Seat Dimensions: • D=19" H=18" • Casters unavailable as standard.														
A B C D E F G H I J														

HOW TO ORDER

- Indicate the following information on order form:
- Quantity of each item.
 - Model number, including options. See "How To Build a Model Number".
 - Any special service required.

Note: • The indicates that a choice is required.
 • The absence of the indicates that no choice is required.
 • Alpha-numeric characters in place of indicate that no other alternatives are available.

HOW TO BUILD A MODEL NUMBER

- A** Select basic model.
- B** Non-contrast or fabric contrast 1
Refer to ki.com/fabrics.
• For yardage pricing, see Fabric Yardage Pricing page
- C** Select fabric contrast 2.
Refer to ki.com/fabrics.
• For yardage pricing, see Fabric Yardage Pricing page
- D** Select fabric contrast 3.
Refer to ki.com/fabrics.
• For yardage pricing, see Fabric Yardage Pricing page
- E** Select power option.
RPT - Mini-Tap power module w/3-prong plug; add \$314
NP - No power
- F** Select Mini-Tap module w/3-prong plug

location.	LFP - Left-facing power
	RFP - Right-facing power
G Select module color.	MPB - Black power module
	MPS - Silver power module
	MPW - White power module
H Select wood feet finish.	Refer to the Product Color Options page in this price list.
I Select brushed aluminum feet finish.	Refer to the Product Color Options page in this price list.
J Select moisture barrier.	MB - Moisture barrier
	NMB - No moisture barrier
	See pricing column for moisture barrier upcharge.

SPECIAL SERVICES

Special Carton Marking

With specially marked information N/C

Shipping
Ships **assembled, FOB High Point, NC 27263, freight prepaid.** Freight class 250.

Specifications and prices are subject to change without prior notice.



Features	MODEL NUMBER										Approx. Packaged Weight	Delivered Pricing	Moisture Barrier add to list price	
	Basic Model	Non-Cont or Fabric Cont 1	Fabric Cont 2	Fabric Cont 3	Pwr Opt	Pwr Loc	Pwr Color	Wd Feet Fin	Alum-inum Feet Finish	Moist Barr				
concealed glides shown 	Concealed Glide	MPC060/CGL/NC	<input type="checkbox"/>			<input type="checkbox"/>	<input type="checkbox"/>	<input type="checkbox"/>			<input type="checkbox"/>	92.00#	\$ 1818	\$ 230
	Poly Feet	MPC060/PFT/NC	<input type="checkbox"/>			<input type="checkbox"/>	<input type="checkbox"/>	<input type="checkbox"/>			<input type="checkbox"/>	92.00#	1818	230
	Wood Feet	MPC060/WFT/NC	<input type="checkbox"/>			<input type="checkbox"/>	<input type="checkbox"/>	<input type="checkbox"/>	<input type="checkbox"/>		<input type="checkbox"/>	92.00#	1951	230
	Aluminum Feet	MPC060/AFT/NC	<input type="checkbox"/>			<input type="checkbox"/>	<input type="checkbox"/>	<input type="checkbox"/>		<input type="checkbox"/>	<input type="checkbox"/>	92.00#	1933	230
MCO60 Outside Back, 60° Curve, 32" Low-Back - Non-contrast • Non-contrast C.O.M = 5 yds • Ganging (specify kit separately) Overall Dimensions: • W=54" D=26" H=32" Seat Dimensions: • D=19" H=18" • Casters unavailable as standard.														
concealed glides shown 	Concealed Glide	MPC060/CGL/FC	<input type="checkbox"/>	<input type="checkbox"/>	<input type="checkbox"/>	<input type="checkbox"/>	<input type="checkbox"/>	<input type="checkbox"/>			<input type="checkbox"/>	95.00#	\$ 1851	\$ 230
	Poly Feet	MPC060/PFT/FC	<input type="checkbox"/>	<input type="checkbox"/>	<input type="checkbox"/>	<input type="checkbox"/>	<input type="checkbox"/>	<input type="checkbox"/>			<input type="checkbox"/>	92.00#	1851	230
	Wood Feet	MPC060/WFT/FC	<input type="checkbox"/>	<input type="checkbox"/>	<input type="checkbox"/>	<input type="checkbox"/>	<input type="checkbox"/>	<input type="checkbox"/>	<input type="checkbox"/>		<input type="checkbox"/>	92.00#	1985	230
	Aluminum Feet	MPC060/AFT/FC	<input type="checkbox"/>	<input type="checkbox"/>	<input type="checkbox"/>	<input type="checkbox"/>	<input type="checkbox"/>	<input type="checkbox"/>		<input type="checkbox"/>	<input type="checkbox"/>	92.00#	1933	230
MCO60 Outside Back, 60° Curve, 32" Low-Back - Contrast • 1 = Base (Fabric Contrast 1) C.O.M. = 1.75 yd • 2 = Seat (Fabric Contrast 2) C.O.M. = 1.5 yd • 3 = Back (Fabric Contrast 3) C.O.M. = 1.75 yd • Ganging (specify kit separately) Overall Dimensions: • W=54" D=26" H=32" Seat Dimensions: • D=19" H=18" • Casters unavailable as standard.														
A B C D E F G H I J														

HOW TO ORDER

Indicate the following information on order form:

- Quantity of each item.
- Model number, including options. See "How To Build a Model Number".
- Any special service required.

Note:

- The indicates that a choice is required.
- The absence of the indicates that no choice is required.
- Alpha-numeric characters in place of indicate that no other alternatives are available.

HOW TO BUILD A MODEL NUMBER

A Select basic model.

B Non-contrast or fabric contrast 1
Refer to ki.com/fabrics.
• For yardage pricing, see Fabric Yardage Pricing page

C Select fabric contrast 2.
Refer to ki.com/fabrics.
• For yardage pricing, see Fabric Yardage Pricing page

D Select fabric contrast 3.
Refer to ki.com/fabrics.
• For yardage pricing, see Fabric Yardage Pricing page

E Select power option.
RPT - Mini-Tap power module w/3-prong plug; add \$314
NP - No power

F Select Mini-Tap module w/3-prong plug location.

LFP - Left-facing power
RFP - Right-facing power

G Select module color.
MPB - Black power module
MPS - Silver power module
MPW - White power module

H Select wood feet finish.
Refer to the **Product Color Options** page in this price list.

I Select brushed aluminum feet finish.
Refer to the **Product Color Options** page in this price list.

J Select moisture barrier.
MB - Moisture barrier
NMB - No moisture barrier
See pricing column for moisture barrier upcharge.

SPECIAL SERVICES

Special Carton Marking
With specially marked information N/C

Shipping
Ships **assembled, FOB High Point, NC 27263, freight prepaid.** Freight class 250.

Specifications and prices are subject to change without prior notice.



Features	MODEL NUMBER											Approx. Packaged Weight	Delivered Pricing	Moisture Barrier add to list price
	Basic Model	Non-Cont or Fabric Cont 1	Fabric Cont 2	Fabric Cont 3	Pwr Opt	Pwr Loc	Pwr Color	Wd Feet Fin	Alum-inum Feet Finish	Moist Barr				
concealed glides shown	Concealed Glide	MPICB/CGL/NC	<input type="checkbox"/>			<input type="checkbox"/>	<input type="checkbox"/>	<input type="checkbox"/>			<input type="checkbox"/>	120.00#	\$ 2311	\$ 350
	Poly Feet	MPICB/PFT/NC	<input type="checkbox"/>			<input type="checkbox"/>	<input type="checkbox"/>	<input type="checkbox"/>			<input type="checkbox"/>	120.00#	2311	350
	Wood Feet	MPICB/WFT/NC	<input type="checkbox"/>			<input type="checkbox"/>	<input type="checkbox"/>	<input type="checkbox"/>	<input type="checkbox"/>		<input type="checkbox"/>	120.00#	2442	350
	Aluminum Feet	MPICB/AFT/NC	<input type="checkbox"/>			<input type="checkbox"/>	<input type="checkbox"/>	<input type="checkbox"/>		<input type="checkbox"/>	<input type="checkbox"/>	120.00#	2442	350
MICB														
Inside Back, 90° Curve, 32" Low-Back - Non-contrast														
<ul style="list-style-type: none"> Non-contrast C.O.M = 8 yds Ganging (specify kit separately) Overall Dimensions: <ul style="list-style-type: none"> W=76-1/2" D=26" H=32" Seat Dimensions: <ul style="list-style-type: none"> D=19" H=18" Casters unavailable as standard. 														
concealed glides shown	Concealed Glide	MPICB/CGL/FC	<input type="checkbox"/>	<input type="checkbox"/>	<input type="checkbox"/>	<input type="checkbox"/>	<input type="checkbox"/>	<input type="checkbox"/>			<input type="checkbox"/>	120.00#	\$ 2378	\$ 350
	Poly Feet	MPICB/PFT/FC	<input type="checkbox"/>	<input type="checkbox"/>	<input type="checkbox"/>	<input type="checkbox"/>	<input type="checkbox"/>	<input type="checkbox"/>			<input type="checkbox"/>	120.00#	2378	350
	Wood Feet	MPICB/WFT/FC	<input type="checkbox"/>	<input type="checkbox"/>	<input type="checkbox"/>	<input type="checkbox"/>	<input type="checkbox"/>	<input type="checkbox"/>	<input type="checkbox"/>		<input type="checkbox"/>	120.00#	2508	350
	Aluminum Feet	MPICB/AFT/FC	<input type="checkbox"/>	<input type="checkbox"/>	<input type="checkbox"/>	<input type="checkbox"/>	<input type="checkbox"/>	<input type="checkbox"/>		<input type="checkbox"/>	<input type="checkbox"/>	120.00#	2508	350
MICB														
Inside Back, 90° Curve, 32" Low-Back - Contrast														
<ul style="list-style-type: none"> 1 = Base (Fabric Contrast 1) C.O.M. = 2.75 yd 2 = Seat (Fabric Contrast 2) C.O.M. = 1.75 yd 3 = Back (Fabric Contrast 3) C.O.M. = 4 yd Ganging (specify kit separately) Overall Dimensions: <ul style="list-style-type: none"> W=76-1/2" D=26" H=32" Seat Dimensions: <ul style="list-style-type: none"> D=19" H=18" Casters unavailable as standard. 														
			A	B	C	D	E	F	G	H	I	J		

HOW TO ORDER

- Indicate the following information on order form:
- Quantity of each item.
 - Model number, including options. See "How To Build a Model Number".
 - Any special service required.

Note: • The indicates that a choice is required.
 • The absence of the indicates that no choice is required.
 • Alpha-numeric characters in place of indicate that no other alternatives are available.

HOW TO BUILD A MODEL NUMBER

- A** Select basic model.
- B** Non-contrast or fabric contrast 1
Refer to ki.com/fabrics.
• For yardage pricing, see Fabric Yardage Pricing page
- C** Select fabric contrast 2.
Refer to ki.com/fabrics
• For yardage pricing, see Fabric Yardage Pricing page
- D** Select fabric contrast 3.
Refer to ki.com/fabrics
• For yardage pricing, see Fabric Yardage Pricing page
- E** Select power option.
RPT - Mini-Tap power module w/3-prong plug; add \$314
NP - No power
- F** Select Mini-Tap module w/3-prong plug

- location.
LFP - Left-facing power
RFP - Right-facing power
- G** Select module color.
MPB - Black power module
MPS - Silver power module
MPW - White power module
- H** Select wood feet finish.
Refer to the **Product Color Options** page in this price list.
- I** Select brushed aluminum feet finish.
Refer to the **Product Color Options** page in this price list.
- J** Select moisture barrier.
MB - Moisture barrier
NMB - No moisture barrier
See pricing column for moisture barrier upcharge.

SPECIAL SERVICES

Special Carton Marking

With specially marked information N/C

Shipping

Ships assembled, FOB High Point, NC 27263, freight prepaid. Freight class 250.

Specifications and prices are subject to change without prior notice.



Features	MODEL NUMBER											Approx. Packaged Weight	Delivered Pricing	Moisture Barrier add to list price		
	Basic Model	Non-Cont or Fabric Cont 1	Fabric Cont 2	Fabric Cont 3	Pwr Opt	Pwr Loc	Pwr Color	Wd Feet Fin	Alum-inum Feet Finish	Moist Barr						
concealed glides shown 	Concealed Glide	MPOCB/CGL/NC	<input type="checkbox"/>				<input type="checkbox"/>	<input type="checkbox"/>	<input type="checkbox"/>					100.00#	\$ 2201	\$ 320
	Poly Feet	MPOCB/PFT/NC	<input type="checkbox"/>				<input type="checkbox"/>	<input type="checkbox"/>	<input type="checkbox"/>					100.00#	2201	320
	Wood Feet	MPOCB/WFT/NC	<input type="checkbox"/>				<input type="checkbox"/>	<input type="checkbox"/>	<input type="checkbox"/>	<input type="checkbox"/>				100.00#	2331	320
	Aluminum Feet	MPOCB/AFT/NC	<input type="checkbox"/>				<input type="checkbox"/>	<input type="checkbox"/>	<input type="checkbox"/>		<input type="checkbox"/>	<input type="checkbox"/>		100.00#	2331	320
MOCB																
Outside Back, 90° Curve, 32" Low-Back - Non-contrast																
<ul style="list-style-type: none"> • Non-contrast C.O.M = 6.5 yds • Ganging (specify kit separately) Overall Dimensions: <ul style="list-style-type: none"> • W=76-1/2" D=26" H=32" Seat Dimensions: <ul style="list-style-type: none"> • D=19" H=18" • Casters unavailable as standard. 																
concealed glides shown 	Concealed Glide, Contrast	MPOCB/CGL/FC	<input type="checkbox"/>	<input type="checkbox"/>	<input type="checkbox"/>	<input type="checkbox"/>	<input type="checkbox"/>	<input type="checkbox"/>						100.00#	\$ 2267	\$ 320
	Poly Feet, Contrast	MPOCB/PFT/FC	<input type="checkbox"/>	<input type="checkbox"/>	<input type="checkbox"/>	<input type="checkbox"/>	<input type="checkbox"/>	<input type="checkbox"/>						100.00#	2267	320
	Wood Feet	MPOCB/WFT/FC	<input type="checkbox"/>	<input type="checkbox"/>	<input type="checkbox"/>	<input type="checkbox"/>	<input type="checkbox"/>	<input type="checkbox"/>	<input type="checkbox"/>					100.00#	2397	320
	Aluminum Feet	MPOCB/AFT/FC	<input type="checkbox"/>	<input type="checkbox"/>	<input type="checkbox"/>	<input type="checkbox"/>	<input type="checkbox"/>	<input type="checkbox"/>		<input type="checkbox"/>	<input type="checkbox"/>			100.00#	2397	320
MOCB																
Outside Back, 90° Curve, 32" Low-Back - Contrast																
<ul style="list-style-type: none"> • 1 = Base (Fabric Contrast 1) C.O.M. = 2.75 yd • 2 = Seat (Fabric Contrast 2) C.O.M. = 1.75 yd • 3 = Back (Fabric Contrast 3) C.O.M. = 2.5 yd • Ganging (specify kit separately) Overall Dimensions: <ul style="list-style-type: none"> • W=76-1/2" D=26" H=32" Seat Dimensions: <ul style="list-style-type: none"> • D=19" H=18" • Casters unavailable as standard. 																
A B C D E F G H I J																

HOW TO ORDER

Indicate the following information on order form:

- Quantity of each item.
- Model number, including options. See "How To Build a Model Number".
- Any special service required.

Note:

- The indicates that a choice is required.
- The absence of the indicates that no choice is required.
- Alpha-numeric characters in place of indicate that no other alternatives are available.

HOW TO BUILD A MODEL NUMBER

A Select basic model.

B Non-contrast or fabric contrast 1
Refer to ki.com/fabrics.
• For yardage pricing, see Fabric Yardage Pricing page

C Select fabric contrast 2.
Refer to ki.com/fabrics
• For yardage pricing, see Fabric Yardage Pricing page

D Select fabric contrast 3.
Refer to ki.com/fabrics
• For yardage pricing, see Fabric Yardage Pricing page

E Select power option.
RPT - Mini-Tap power module w/3-prong plug; add \$314
NP - No power

F Select Mini-Tap module w/3-prong plug location.

LFP - Left-facing power
RFP - Right-facing power

G Select module color.
MPB - Black power module
MPS - Silver power module
MPW - White power module

H Select wood feet finish.
Refer to the **Product Color Options** page in this price list.

I Select brushed aluminum feet finish.
Refer to the **Product Color Options** page in this price list.

J Select moisture barrier.
MB - Moisture barrier
NMB - No moisture barrier
See pricing column for moisture barrier upcharge.

SPECIAL SERVICES

Special Carton Marking
With specially marked information N/C

Shipping
Ships assembled, FOB High Point, NC 27263, freight prepaid. Freight class 250.

Specifications and prices are subject to change without prior notice.



Inside Back 45° Curve with 48" High-Back

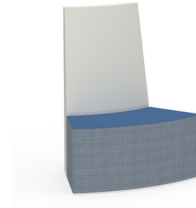

Outside Back 45° Curve with 48" High-Back

General Dimensions		
Seat width	21"	21"
Seat depth	19"	19"
Seat height	18"	18"
Overall Dimensions		
Width	41-1/2"	41-1/2"
Depth	28"	28"
Height	48"	48"

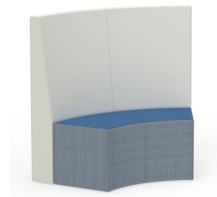

Inside Back 60° Curve with 48" High-Back

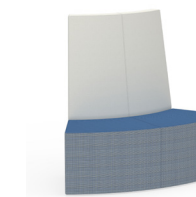

Outside Back 60° Curve with 48" High-Back

General Dimensions		
Seat width	28"	28"
Seat depth	19"	19"
Seat height	18"	18"
Overall Dimensions		
Width	54"	54"
Depth	30"	30"
Height	48"	48"

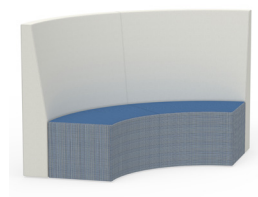

Inside Back 90° Curve with 48" High-Back

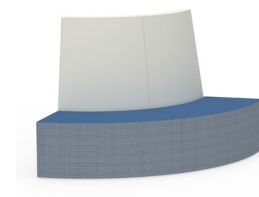

Outside Back 90° Curve with 48" High-Back

General Dimensions		
Seat width	39-3/4"	39-3/4"
Seat depth	19"	19"
Seat height	18"	18"
Overall Dimensions		
Width	76-1/2"	76-1/2"
Depth	33-1/2"	33-1/2"
Height	48"	48"

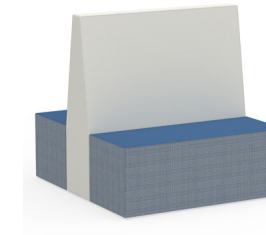

Booth with 48" High-Back

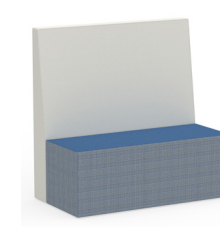

Rectangle with 48" High-Back



Lounge Chair with 48" High-Back

General Dimensions			
Seat width		48"	26"
Seat depth	19-2/5"	19"	19"
Seat height	18"	18"	18"
Back Depth			
Overall Dimensions			
Width	48"	48"	26"
Depth	52"	26"	26"
Height	48"	48"	48"

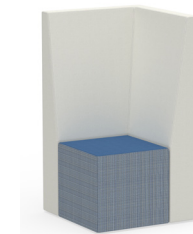

Corner with 48" High-Back (Right and Left)

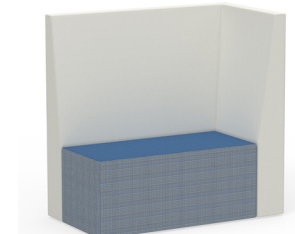

Extended Corner with 48" High-Back (Right and Left)

General Dimensions			
Seat width	19"		
Seat depth	19"		18-1/2"
Seat height	18"		18"
Back Depth			26"
Overall Dimensions			
Width	26"		48"
Depth	26"		26"
Height	48"		48"



Inside Back 45° Curve with 60" High-Back



Outside Back 45° Curve with 60" High-Back

General Dimensions		
Seat width	21"	21"
Seat depth	19"	19"
Seat height	18"	18"
Overall Dimensions		
Width	41-1/2"	41-1/2"
Depth	28"	28"
Height	60"	60"



Inside Back 60° Curve with 60" High-Back

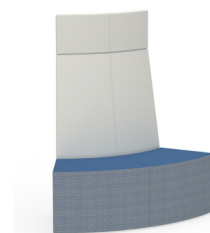

Outside Back 60° Curve, 60" High-Back

General Dimensions		
Seat width	28"	28"
Seat depth	19"	19"
Seat height	18"	18"
Overall Dimensions		
Width	54"	54"
Depth	30"	30"
Height	60"	60"

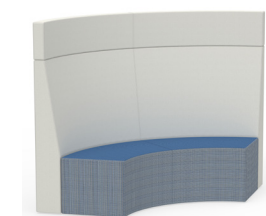

Inside Back 90° Curve with 60" High-Back

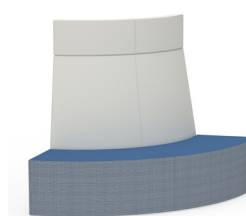

Outside Back 90° Curve with 60" High-Back

General Dimensions		
Seat width	39-3/4"	39-3/4"
Seat depth	19"	19"
Seat height	18"	18"
Overall Dimensions		
Width	76-1/2"	76-1/2"
Depth	33-1/2"	33-1/2"
Height	60"	60"

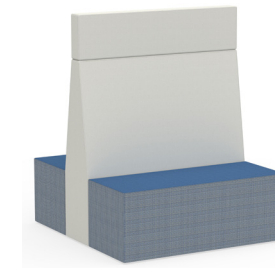

Booth with 60" High-Back

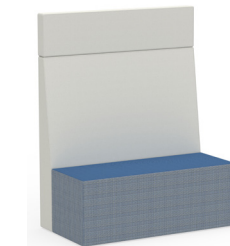

Rectangle with 60" High-Back

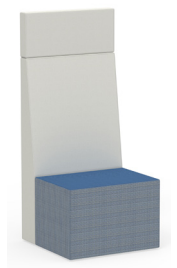

Lounge Chair with 60" High-Back

General Dimensions		
Seat width	48"	26"
Seat depth	19-2/5"	19"
Seat height	18"	18"
Back Depth		
Overall Dimensions		
Width	48"	26"
Depth	52"	26"
Height	60"	60"

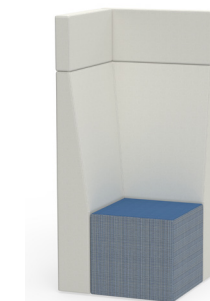
Corner with 60" High-Back
(Right and Left)Extended Corner with 60" High-Back
(Right and Left)

General Dimensions		
Seat width	19"	
Seat depth	19"	18-1/2"
Seat height	18"	18"
Back Depth		26"
Overall Dimensions		
Width	26"	48"
Depth	26"	26"
Height	60"	60"



Frame

All seat and backrest frames are constructed of 3/4" laminated hardwood plywood, CNC cut. All main frame joints are nailed and glued, in addition to interlocking joinery across all stress points. Seats are removeable without tools for cleaning and electrical inspection. Frame bases are coated with a black stain and sealer to seal and protect wooden frames from liquid spills. The seat base contains multiple pass-through cutouts to allow liquid and debris to route to the floor. Seats feature a curved clean-out space to route liquid and debris towards floor.

Foam

All MyPlace High-Back models use seat foam that is 2.5" thick, 2.5 density - 45 lb compression, topped with 1/2" thick, 2.6 density - 80 lb compression foam. The backrest foam is 1 1/2" total thickness consisting of 1" thick, 2.5 density - 45 lb compression foam, and topped with a 1/2" thick, 2.6 density - 80 lb compression foam. The headrest topper has 1 3/8" thick, 2.5 density - 45 lb compression foam on the seating side. All non-seating sides have a 3/4" thick, 2.6 density - 80 lb compression foam covering.

Sewing

All MyPlace Lounge units are double-needle stitched at all primary seams for lasting durability.

Base Options

Poly Feet

Poly feet are 2" high polyurethane, and contain an adjustable glide. The height-adjustable steel 1/4-20 threaded, natural color, impact resistant nylon glide bottom allows for 3/4" of leveling. Poly feet are mounted to the underside frame using 5/16-18 x 1 1/2" set screws. Feet are black in color with four or five feet used per lounge, depending upon model.

Wood Feet

Wood feet are 2" high and made from 2" x 2" x 2" beech hardwood, kiln dried to a moisture content of 6%. Exposed wood is sanded with 220 grit sand paper, then spray stained with KI standard colors, or a non-standard color match and placed in a burn-off oven for one hour at 140-150 degrees. The wood is then sealed to prevent moisture imbalance and finish sanded with 400 grit sand paper for fine detailing. The final step for wood feet is the application of a varnish topcoat, then feet are oven baked. Both the sealer and finish coats contain an anti-microbial protectant. A height-adjustable steel 1/4-20 threaded, natural color, impact resistant nylon glide bottom allows for 3/4" of leveling. Four to five wood feet are used per lounge depending upon model. See KI color addendum for stain color offering.

Cast Aluminum Feet

Cast aluminum feet are 2" high and mounted to the underside frame using 5/16-18 x 1 1/2" set screws. Feet are offered in brushed aluminum or painted in powder-coat paint with four or five feet used per lounge, depending upon model. A height-adjustable steel 1/4-20 threaded, natural color, impact resistant nylon glide bottom allows for 3/4" of leveling. See KI Color Addendum for paint color offering.

Concealed Glides

Concealed glides are height-adjustable steel, 1/4-20 threaded with a natural color nylon bottom allowing for 3/4" of leveling. Four to five adjustable glides are used per lounge depending upon model.

Ganging

Gangers are made from steel and are either, painted with a black finish and are mounted using #10 x 3/4" wood screws.

- 60" high-back gangers - formed of 12-gauge steel. Gangers included with 60" high-back lounge models.
- High-back base gangers - formed of 14-gauge steel. Gangers included with all 48" and 60" high-back models.
- 48" high-back catch & hook gangers - formed 10-gauge steel. Gangers included with all 48" high-back models.
- High-back to low-back, backless or inline table gangers - formed of 12-gauge steel. Gangers must be ordered separately. See MyPlace Lounge Furniture - Planning Guide (KI-PG-000020) for more information.

Electrical System Options

Byrne Mini-Tap® Power Module with 3-Prong Plug

MyPlace High-Back can be configured with optional Byrne Mini-Tap® power modules with 3-prong plug (a self-contained, UL listed single relocatable power tap). One 15-amp, 125 volt AC simplex receptacle with one 2.1-amp, 5 volt DC USB-A port, and one USB-C port (2.0 and 3.0 compatible, no data), provide connection for device charging or direct AC power. Byrne Mini-Tap® power module is standard with 72" long, 14 AWG, 15-amp NEMA rated 3-conductor SJT cord with a three-prong grounded plug. The 3-prong plug is oriented straight off the power cord. Faceplates are optionally either black in color with black outlet ports, white with white outlet ports, or silver with black outlet ports. Cord is black.

One Byrne Mini-Tap® power module with 3-prong plug is available per model, and may be configurable for front and rear power outlets. See MyPlace Lounge Furniture - Planning Guide (KI-PG-000020) for configurable power locations.

Byrne Interlink® IQ System

Optionally, MyPlace High-Back can be configured with Byrne Interlink® IQ system (an ETL-Listed, 120-volt single circuit electrical system). Interlink® IQ is a non-sequential power system that allows users to "daisy-chain" multiple power modules together powered by one infeed (ordered separately). The infeed cord is a 10' long, 14 AWG, 15-amp NEMA rated 3-conductor SJT cord with a three-prong grounded plug. Faceplates are optionally either black in color with black outlet ports, white with white outlet ports, or silver with black outlet ports. Cord is black.

Byrne Mini-Tap® Power Module for Interlink IQ

Up to eight total Byrne Mini-Tap power modules for Interlink IQ can be configured in a multi-lounge plan, and are configured as part of the lounge units. Modules contain one 15-amp, 125 volt AC simplex receptacle with one 2.1-amp, 5 volt DC USB-A port, and one USB-C port (2.0 and 3.0 compatible, no data), providing connection for device charging or direct AC power. The module to module cord connections are keyed and light indicated for proper hook up.

Up to four power modules per lounge are available, depending upon model, and may be configurable for front and rear power outlets. See the planning guide for configurable power locations.

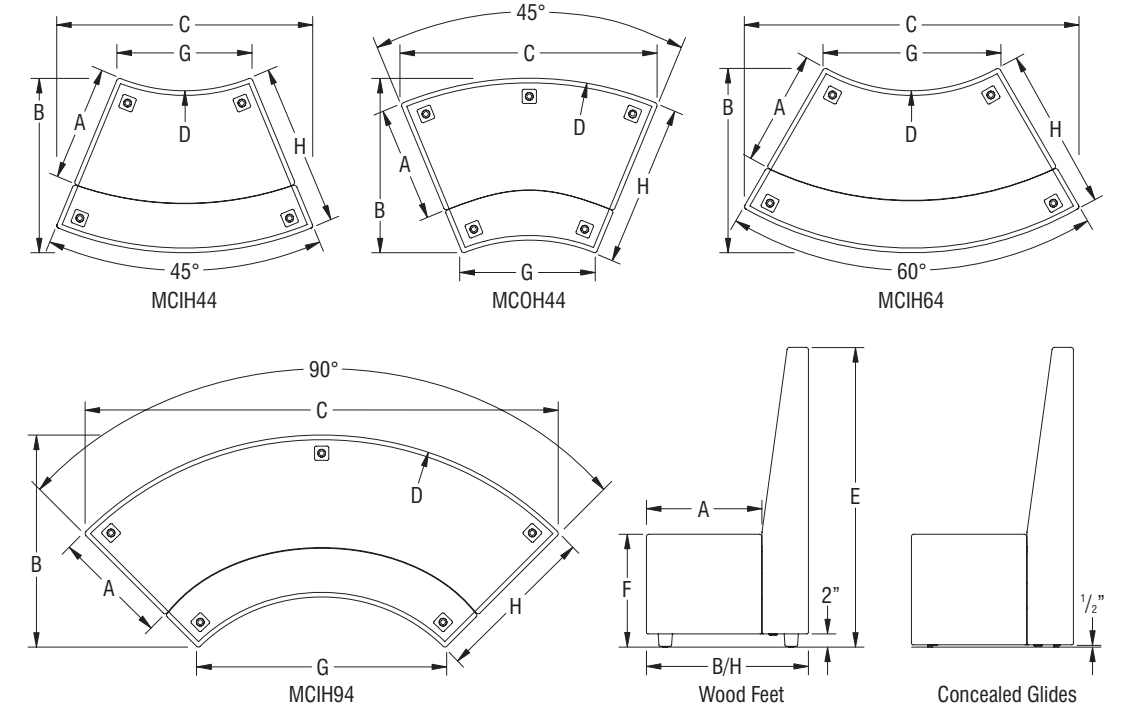
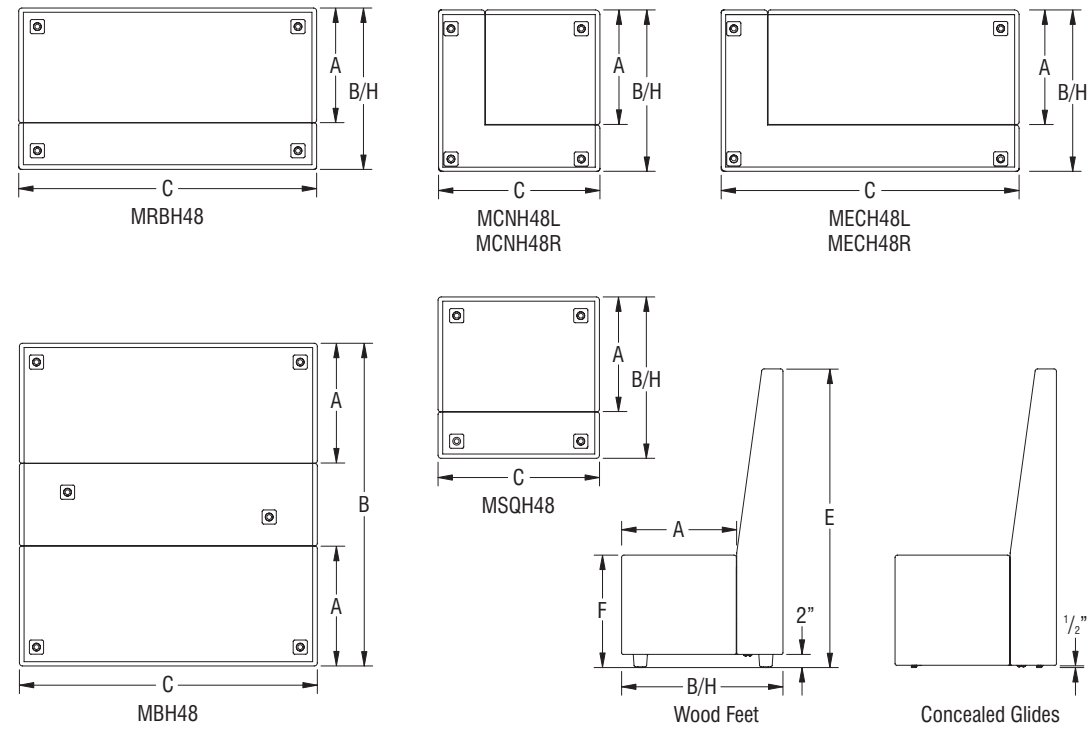

Lounge Overall Dimension								
Model	A (Seat Depth)	B (Overall Depth)	C (Overall Width)	D (Radius)	E (Overall Height)	F (Seat Height)	G (Seat Width)	H (Back Depth)
MSQH48	18 1/2"	26"	26"		48"	18"		26"
MRBH48	18 1/2"	26"	48"		48"	18"		26"
MBH48	19 3/8"	52"	48"		48"	18"		
MCNH48L	18 1/2"	26"	26"		48"	18"		26"
MCNH48R	18 1/2"	26"	26"		48"	18"		26"
MECH48L	18 1/2"	26"	48"		48"	18"		26"
MECH48R	18 1/2"	26"	48"		48"	18"		26"

Lounge Overall Dimension									
Model	A (Seat Depth)	B (Overall Depth)	C (Overall Width)	D (Radius)	E (Overall Height)	F (Seat Height)	G (Seat Width)	H (Back Depth)	
MCIH44	18 1/2"	28"	41 1/2"	28"	48"	18"	21"	26"	
MCOH44	18 1/2"	28"	41 1/2"	54"	48"	18"	41"	26"	
MCIH64	18 1/2"	29 1/2"	54"	28"	48"	18"	28"	26"	
MCOH64	18 1/2"	29 1/2"	54"	54"	48"	18"	54"	26"	
MCIH94	18 1/2"	34"	76 1/2"	28"	48"	18"	40"	26"	
MCOH94	18 1/2"	34"	76 1/2"	54"	48"	18"	76"	26"	

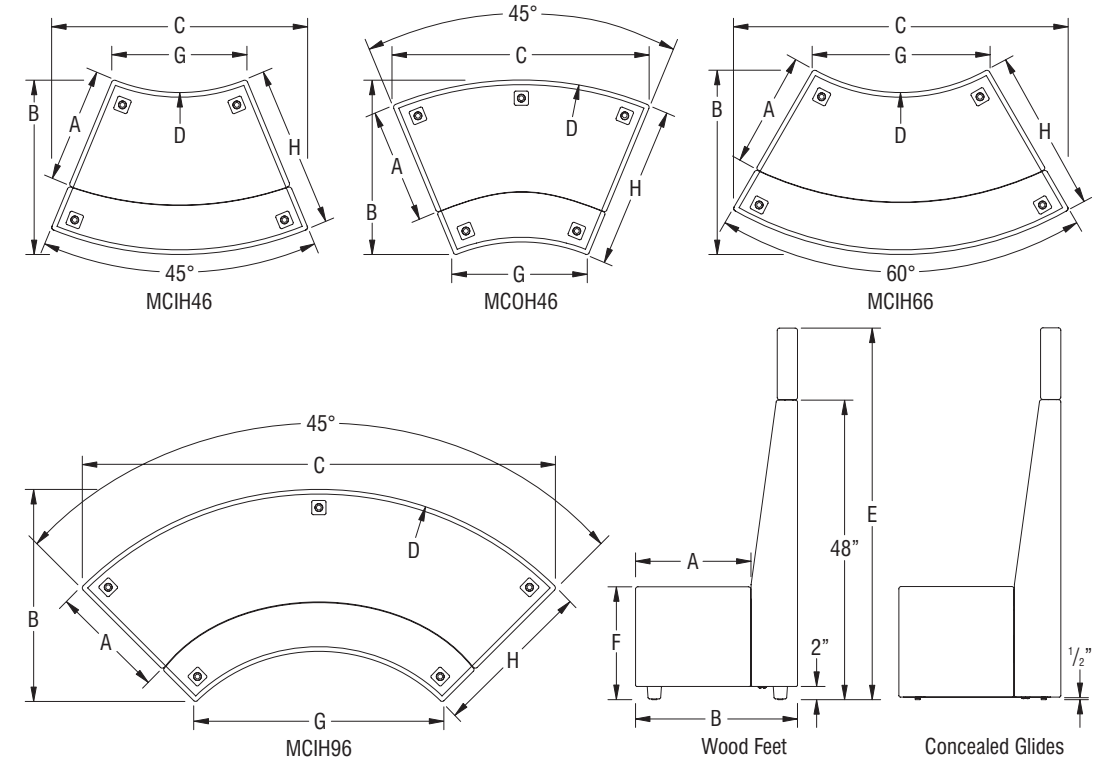
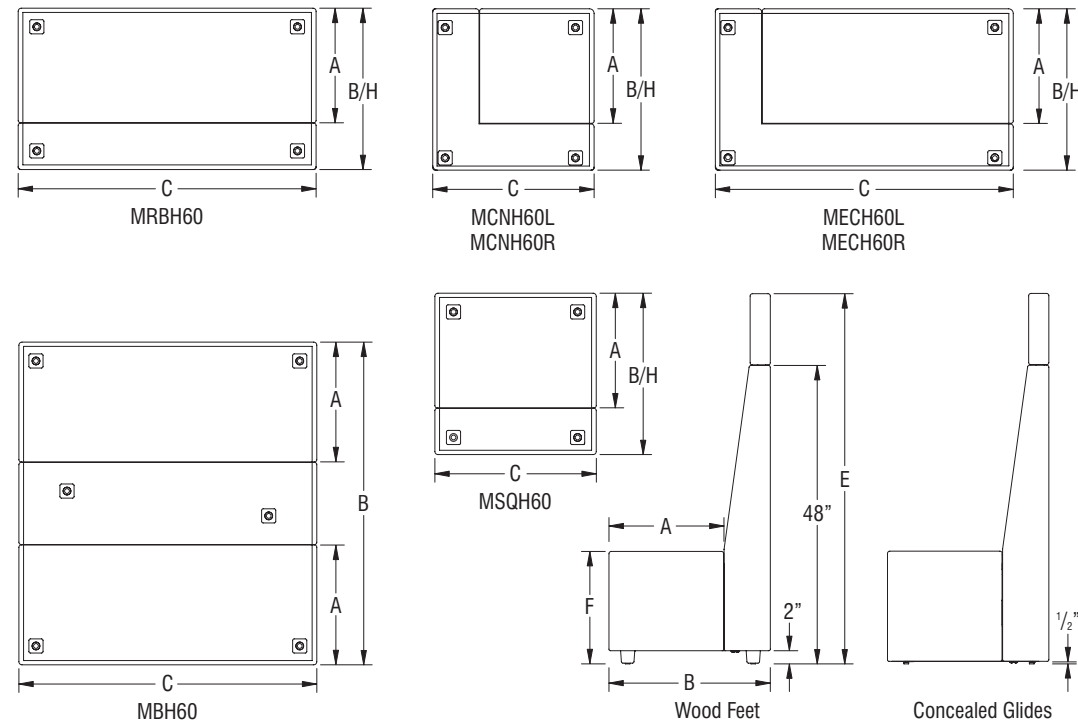

Lounge Overall Dimension								
Model	A (Seat Depth)	B (Overall Depth)	C (Overall Width)	D (Radius)	E (Overall Height)	F (Seat Height)	G (Seat Width)	H (Back Depth)
MSQH60	18 1/2"	26"	26"		60"	18"		26"
MRBH60	18 1/2"	26"	48"		60"	18"		26"
MBH60	19 3/8"	52"	48"		60"	18"		
MCNH60L	18 1/2"	26"	26"		60"	18"		26"
MCNH60R	18 1/2"	26"	26"		60"	18"		26"
MECH60L	18 1/2"	26"	48"		60"	18"		26"
MECH60R	18 1/2"	26"	48"		60"	18"		26"

Lounge Overall Dimension								
Model	A (Seat Depth)	B (Overall Depth)	C (Overall Width)	D (Radius)	E (Overall Height)	F (Seat Height)	G (Seat Width)	H (Back Depth)
MCIH46	18 1/2"	28"	41 1/2"	28"	60"	18"	21"	26"
MCOH46	18 1/2"	28"	41 1/2"	54"	60"	18"	41"	26"
MCIH66	18 1/2"	29 1/2"	54"	28"	60"	18"	28"	26"
MCOH66	18 1/2"	29 1/2"	54"	54"	60"	18"	54"	26"
MCIH96	18 1/2"	34"	76 1/2"	28"	60"	18"	40"	26"
MCOH96	18 1/2"	34"	76 1/2"	54"	60"	18"	76"	26"



Features	MODEL NUMBER														Approx. Packaged Weight	Delivered Pricing	Moisture Barrier add to list price		
	Basic Model	Non-Contrast or Fabric Cont 1	Fabric Cont 2	Fabric Cont 3	Pwr Opt	Pwr Type	MT Pwr Loc	IQ Pwr Type	IQ Mod Qty	IQ Pwr Loc	Pwr Color	Wd Feet Fin	Alum Feet Fin	Moist Barr					
concealed glides shown	Concealed Glides	MSQH48/CGL/FC	<input type="checkbox"/>	<input type="checkbox"/>	<input type="checkbox"/>	<input type="checkbox"/>	<input type="checkbox"/>	<input type="checkbox"/>	<input type="checkbox"/>	<input type="checkbox"/>	<input type="checkbox"/>	<input type="checkbox"/>	<input type="checkbox"/>	<input type="checkbox"/>	<input type="checkbox"/>	<input type="checkbox"/>	100.00#	\$ 2249	\$ 244
	Poly Feet	MSQH48/PFT/FC	<input type="checkbox"/>	<input type="checkbox"/>	<input type="checkbox"/>	<input type="checkbox"/>	<input type="checkbox"/>	<input type="checkbox"/>	<input type="checkbox"/>	<input type="checkbox"/>	<input type="checkbox"/>	<input type="checkbox"/>	<input type="checkbox"/>	<input type="checkbox"/>	<input type="checkbox"/>	<input type="checkbox"/>	100.00#	2249	244
	Wood Feet	MSQH48/WFT/FC	<input type="checkbox"/>	<input type="checkbox"/>	<input type="checkbox"/>	<input type="checkbox"/>	<input type="checkbox"/>	<input type="checkbox"/>	<input type="checkbox"/>	<input type="checkbox"/>	<input type="checkbox"/>	<input type="checkbox"/>	<input type="checkbox"/>	<input type="checkbox"/>	<input type="checkbox"/>	<input type="checkbox"/>	100.00#	2376	244
	Aluminum Feet	MSQH48/AFT/FC	<input type="checkbox"/>	<input type="checkbox"/>	<input type="checkbox"/>	<input type="checkbox"/>	<input type="checkbox"/>	<input type="checkbox"/>	<input type="checkbox"/>	<input type="checkbox"/>	<input type="checkbox"/>	<input type="checkbox"/>	<input type="checkbox"/>	<input type="checkbox"/>	<input type="checkbox"/>	<input type="checkbox"/>	100.00#	2376	244

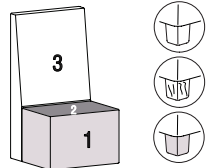

- MSQ48
Lounge Chair, 48" High-Back - Contrast
- 1 = Base (Contrast 1) COM= 1.25 yd
 - 2 = Seat (Contrast 2) COM= .75 yd
 - 3 = Back (Contrast 3) COM= 2.75 yd
 - Gangers included to gang to other High-Back models.
 - Ganging to backless units or High-Back back to side ganging (specify kit separately)
 - Does not gang with 32" Low-Back units
 - Cannot be retrofitted to 60" model
 - All base models have foot leveling capacity
 - Removable seat design, debris clean-out location, and painted wood base to protect against liquids.
 - Overall Dimensions:
• W=26" D=26" H=48"
 - Seat Dimensions:
• D=18.5" H=18"

HOW TO ORDER

- Indicate the following information on order form:
1. Quantity of each item.
 2. Model number, including options. See "How To Build a Model Number".
 3. Any special service required.

Note: • The indicates that a choice is required.
• The absence of the indicates that no choice is required.
• Alpha-numeric characters in place of indicate that no other alternatives are available.

HOW TO BUILD A MODEL NUMBER

- A** Select basic model.
- B** Select non-contrast or fabric contrast 1. Refer to ki.com/fabrics.
• For yardage pricing, see Fabric Yardage Pricing page
- C** Select fabric contrast 2. Refer to ki.com/fabrics.
• For yardage pricing, see Fabric Yardage Pricing page
- D** Select fabric contrast 3. Refer to ki.com/fabrics.
• For yardage pricing, see Fabric Yardage Pricing page
- E** Select power option.
NP - No power
WP - With power
- F** Select power type.
DCP - Byrne Interlink IQ System w/Mini-Tap module OR jumper (Interlink IQ Infeed to power Interlink IQ Systems ordered separately)
RPT - Mini-Tap power module w/3-prong plug; add \$314

- G** Select Mini-Tap® module w/3-prong plug location.
LFFP - Left front facing power
LRFP - Left rear facing power
RFFP - Right front facing power
RRFP - Right rear facing power
- H** Select Byrne Interlink®IQ System type.
DCJ - Byrne Interlink IQ System jumper only; add \$124
DSMOD - Byrne Interlink IQ System w/Mini-Tap module
- I** Select Byrne Interlink®IQ System w/Mini-Tap® module quantity.
MOD1 - One module; add \$404
MOD2 - Two Modules; add \$807
MOD3 - Three modules; add \$1211
MOD4 - Four modules; add \$1614
- J** Select Byrne Interlink® IQ System w/Mini-Tap Module location(s).
LFFP - Left front facing power
LRFP - Left rear facing power
RFFP - Right front facing power
RRFP - Right rear facing power
LFLR - Left front, left rear facing power

- K** Select module color.
MPB - Black power module
MPS - Silver power module
MPW - White power module
- L** Select wood feet finish. Refer to the **Product Color Options** page in this price list.
- M** Select brushed aluminum feet finish. Refer to the **Product Color Options** page in this price list.
- N** Select moisture barrier.
MB - Moisture barrier
NMB - No moisture barrier

See pricing column for moisture barrier upcharge.

INFORMATION

The removable seat design of MyPlace™ High-Back units allows for ease of installation and clean out, as well as inspection of electrical components. MyPlace™ High-Back offers power modules with a 3-prong plug (ETL Listed) or Byrne Interlink® IQ electrical system (an ETL Listed Furniture Power Distribution Unit, electrical system.) Because the system is ETL Listed, MyPlace™ Lounge has not been listed. All 48" high-back models can be used as free-standing units or can be ganged to other 48" high-back or 60" high-back models. Gangers are included for traditional lineal ganging with 48" high-back models, however, please note installing concealed gangers on 48" high-back models will permanently alter upholstery. Please see Installation Guide for further information related to ganging.

SPECIAL SERVICES

Special Carton Marking

With specially marked information N/C

Shipping
Ships **assembled, FOB High Point, NC 27263, freight prepaid.** Freight class 250.

Specifications and prices are subject to change without prior notice.



Features	MODEL NUMBER												Approx. Packaged Weight	Delivered Pricing	Moisture Barrier add to list price	
	Basic Model	Non-Cont or Fabric Cont 1	Pwr Opt	Pwr Type	MT Pwr Loc	IQ Pwr Type	IQ Mod Qty	IQ Pwr Loc	Pwr Color	Wood Feet Finish	Alum-inum Feet Finish	Moist Barr				
concealed glides shown	Concealed Glides	MRBH48/CGL/NC	<input type="checkbox"/>	<input type="checkbox"/>	<input type="checkbox"/>	<input type="checkbox"/>	<input type="checkbox"/>	<input type="checkbox"/>	<input type="checkbox"/>	<input type="checkbox"/>	<input type="checkbox"/>	<input type="checkbox"/>	<input type="checkbox"/>	160.00#	\$ 2762	\$ 266
	Poly Feet	MRBH48/PFT/NC	<input type="checkbox"/>	<input type="checkbox"/>	<input type="checkbox"/>	<input type="checkbox"/>	<input type="checkbox"/>	<input type="checkbox"/>	<input type="checkbox"/>	<input type="checkbox"/>	<input type="checkbox"/>	<input type="checkbox"/>	<input type="checkbox"/>	160.00#	2762	266
	Wood Feet	MRBH48/WFT/NC	<input type="checkbox"/>	<input type="checkbox"/>	<input type="checkbox"/>	<input type="checkbox"/>	<input type="checkbox"/>	<input type="checkbox"/>	<input type="checkbox"/>	<input type="checkbox"/>	<input type="checkbox"/>	<input type="checkbox"/>	<input type="checkbox"/>	160.00#	2887	266
	Aluminum Feet	MRBH48/AFT/NC	<input type="checkbox"/>	<input type="checkbox"/>	<input type="checkbox"/>	<input type="checkbox"/>	<input type="checkbox"/>	<input type="checkbox"/>	<input type="checkbox"/>	<input type="checkbox"/>	<input type="checkbox"/>	<input type="checkbox"/>	<input type="checkbox"/>	160.00#	2887	266

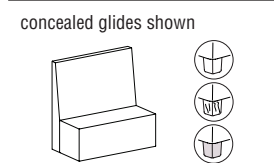

MRB48
Rectangle with 48" High-Back - Non-contrast
 • Non-contrast COM= 5.75 yds
 • Gangers included to gang to other High-Back models.
 • Ganging to backless units or High-Back back to side ganging (specify kit separately)
 • Does not gang with 32" Low-Back units
 • Cannot be retrofitted to 60" model
 • All base models have foot leveling capacity
 • Removable seat design, debris clean-out location, and painted wood base to protect against liquids.
 • Overall Dimensions:
 • W=48" D=26" H=48"
 Seat Dimensions:
 • D=18.5" H=18"

HOW TO ORDER
 Indicate the following information on order form:
 1. Quantity of each item.
 2. Model number, including options. See "How To Build a Model Number".
 3. Any special service required.

Note: • The indicates that a choice is required.
 • The absence of the indicates that no choice is required.
 • Alpha-numeric characters in place of indicate that no other alternatives are available.

HOW TO BUILD A MODEL NUMBER

A Select basic model.

B Select non-contrast or fabric contrast 1. Refer to ki.com/fabrics.
 • For yardage pricing, see Fabric Yardage Pricing page

C Select power option.
NP - No power
WP - With power

D Select power type.
DCP - Byrne Interlink IQ System w/Mini-Tap module OR jumper (Interlink IQ Infeed to power Interlink IQ Systems ordered seperately)
RPT - Mini-Tap power module w/3-prong plug; add \$314

E Select Mini-Tap® module w/3-prong plug location.
LFFP - Left front facing power
LRFP - Left rear facing power
RFFP - Right front facing power
RRFP - Right rear facing power

F Select Byrne Interlink®IQ System type.
DCJ - Byrne Interlink IQ System jumper only; add \$124
DSMOD - Byrne Interlink IQ System w/Mini-Tap module

G Select Byrne Interlink®IQ System w/Mini-Tap® module quantity.
MOD1 - One module; add \$404
MOD2 - Two Modules; add \$807
MOD3 - Three modules; add \$1211
MOD4 - Four modules; add \$1614

H Select Byrne Interlink®IQ System w/Mini-Tap® module location(s).
LFFP - Left front facing power
LRFP - Left rear facing power
RFFP - Right front facing power
RRFP - Right rear facing power
LFLR - Left front, left rear facing power
LFRF - Left front, right front facing power
LFRR - Left front, right rear facing power
LRRF - Left rear, right front facing power
LRRR - Left rear, right rear facing power
RRRF - Right rear, right front facing power
RLRR - Right front, left rear, right rear facing power
LFRR - Left front, right front, left rear facing power
LRFR - Left front, right front, right rear facing power

RFLRRR - Right front, left rear, right rear facing power
LFRR - Left front, right front, left rear, right rear facing power

I Select module color.
MPB - Black power module
MPS - Silver power module
MPW - White power module

J Select wood feet finish. Refer to the **Product Color Options** page in this price list.

K Select brushed aluminum feet finish. Refer to the **Product Color Options** page in this price list.

L Select moisture barrier.
MB - Moisture barrier
NMB - No moisture barrier
 See pricing column for moisture barrier upcharge.

INFORMATION
 The removable seat design of MyPlace™ High-Back units allows for ease of installation and clean out, as well as inspection of electrical components. MyPlace™ High-Back offers power modules with a 3-prong plug (ETL Listed) or Byrne Interlink® IQ electrical system (an ETL Listed Furniture Power Distribution Unit, electrical system.) Because the system is ETL Listed, MyPlace™ Lounge has not been listed. All 48" high-back models can be used as free-standing units or can be ganged to other 48" high-back or 60" high-back models. Gangers are included for traditional lineal ganging with 48" high-back models, however, please note installing concealed gangers on 48" high-back models will permanently alter upholstery. Please see Installation Guide for further information related to ganging.

SPECIAL SERVICES
Special Carton Marking
 With specially marked information N/C

Shipping
 Ships **assembled, FOB High Point, NC 27263, freight prepaid.** Freight class 250.

Specifications and prices are subject to change without prior notice.



Features	MODEL NUMBER														Approx. Packaged Weight	Delivered Pricing	Moisture Barrier add to list price			
	Basic Model	Non-Cont or Fabric Cont 1	Fab Con 2	Fab Con 3	Pwr Opt	Pwr Type	MT Pwr Loc	IQ Pwr Type	IQ Mod Qty	IQ Pwr Loc	Pwr Color	Wood Feet Finish	Alum-inum Feet Finish	Moist Barr						
concealed glides shown	Concealed Glides	MRBH48/CGL/FC	<input type="checkbox"/>	<input type="checkbox"/>	<input type="checkbox"/>	<input type="checkbox"/>	<input type="checkbox"/>	<input type="checkbox"/>	<input type="checkbox"/>	<input type="checkbox"/>	<input type="checkbox"/>	<input type="checkbox"/>	<input type="checkbox"/>	<input type="checkbox"/>	<input type="checkbox"/>			160.00#	\$ 2811	\$ 266
	Poly Feet	MRBH48/PFT/FC	<input type="checkbox"/>	<input type="checkbox"/>	<input type="checkbox"/>	<input type="checkbox"/>	<input type="checkbox"/>	<input type="checkbox"/>	<input type="checkbox"/>	<input type="checkbox"/>	<input type="checkbox"/>	<input type="checkbox"/>	<input type="checkbox"/>	<input type="checkbox"/>	<input type="checkbox"/>			160.00#	2811	266
	Wood Feet	MRBH48/WFT/FC	<input type="checkbox"/>	<input type="checkbox"/>	<input type="checkbox"/>	<input type="checkbox"/>	<input type="checkbox"/>	<input type="checkbox"/>	<input type="checkbox"/>	<input type="checkbox"/>	<input type="checkbox"/>	<input type="checkbox"/>	<input type="checkbox"/>	<input type="checkbox"/>	<input type="checkbox"/>	<input type="checkbox"/>		160.00#	2939	266
	Aluminum Feet	MRBH48/AFT/FC	<input type="checkbox"/>	<input type="checkbox"/>	<input type="checkbox"/>	<input type="checkbox"/>	<input type="checkbox"/>	<input type="checkbox"/>	<input type="checkbox"/>	<input type="checkbox"/>	<input type="checkbox"/>	<input type="checkbox"/>	<input type="checkbox"/>	<input type="checkbox"/>	<input type="checkbox"/>	<input type="checkbox"/>		160.00#	2939	266

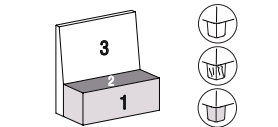

- MRB48
Rectangle with 48" High-Back- Contrast
- 1 = Base (Contrast 1) C.O.M. = 2 yd
 - 2 = Seat (Contrast 2) C.O.M. = .75 yd
 - 3 = Back (Contrast 3) C.O.M. = 4 yd
 - Gangers included to gang to other High-Back models.
 - Ganging to backless units or High-Back back to side ganging (specify kit separately)
 - Does not gang with 32" Low-Back units
 - Cannot be retrofitted to 60" model
 - All base models have foot leveling capacity
 - Removable seat design, debris clean-out location, and painted wood base to protect against liquids.
 - Overall Dimensions:
 - W=48" D=26" H=48"
 - Seat Dimensions:
 - D=18.5" H=18"

HOW TO ORDER

- Indicate the following information on order form:
1. Quantity of each item.
 2. Model number, including options. See "How To Build a Model Number".
 3. Any special service required.

Note: • The indicates that a choice is required.
• The absence of the indicates that no choice is required.
• Alpha-numeric characters in place of indicate that no other alternatives are available.

HOW TO BUILD A MODEL NUMBER

- A** Select basic model.
- B** Select non-contrast or fabric contrast 1. Refer to ki.com/fabrics.
• For yardage pricing, see Fabric Yardage Pricing page
- C** Select fabric contrast 2. Refer to ki.com/fabrics.
• For yardage pricing, see Fabric Yardage Pricing page
- D** Select fabric contrast 3. Refer to ki.com/fabrics.
• For yardage pricing, see Fabric Yardage Pricing page
- E** Select power option.
NP - No power
WP - With power
- F** Select power type.
DCP - Byrne Interlink IQ System w/Mini-Tap module OR jumper (Interlink IQ Infeed to power Interlink IQ Systems ordered seperately)
RPT - Mini-Tap power module w/3-prong plug; add \$314

- G** Select Mini-Tap® module w/3-prong plug location.
LFFP - Left front facing power
LRFP - Left rear facing power
RFFP - Right front facing power
RRFP - Right rear facing power
- H** Select Byrne Interlink®IQ System type.
DCJ - Byrne Interlink IQ System jumper only; add \$124
DSMOD - Byrne Interlink IQ System w/Mini-Tap module
- I** Select Byrne Interlink®IQ System w/Mini-Tap® module quantity.
MOD1 - One module; add \$404
MOD2 - Two Modules; add \$807
MOD3 - Three modules; add \$1211
MOD4 - Four modules; add \$1614
- J** Select Byrne Interlink®IQ System w/Mini-Tap® module location(s).
LFFP - Left front facing power
LRFP - Left rear facing power
RFFP - Right front facing power
RRFP - Right rear facing power
LFLR - Left front, left rear facing power
LFRF - Left front, right front facing power
LFRR - Left front, right rear facing power

- K** Select module color.
MPB - Black power module
MPS - Silver power module
MPW - White power module
- L** Select wood feet finish. Refer to the **Product Color Options** page in this price list.
- M** Select brushed aluminum feet finish. Refer to the **Product Color Options** page in this price list.
- N** Select moisture barrier.
MB - Moisture barrier
NMB - No moisture barrier
See pricing column for moisture barrier upcharge.

INFORMATION

The removable seat design of MyPlace™ High-Back units allows for ease of installation and clean out, as well as inspection of electrical components. MyPlace™ High-Back offers power modules with a 3-prong plug (ETL Listed) or Byrne Interlink® IQ electrical system (an ETL Listed Furniture Power Distribution Unit, electrical system.) Because the system is ETL Listed, MyPlace™ Lounge has not been listed. All 48" high-back models can be used as free-standing units or can be ganged to other 48" high-back or 60" high-back models. Gangers are included for traditional lineal ganging with 48" high-back models, however, please note installing concealed gangers on 48" high-back models will permanently alter upholstery. Please see Installation Guide for further information related to ganging.

SPECIAL SERVICES

Special Carton Marking
With specially marked information N/C

Shipping
Ships assembled, FOB High Point, NC 27263, freight prepaid. Freight class 250.

Specifications and prices are subject to change without prior notice.

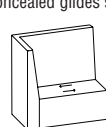

Features	MODEL NUMBER													Approx. Packaged Weight	Delivered Pricing	Moisture Barrier add to list price			
	Basic Model	Non-Cont or Fabric Cont 1	Pwr Opt	Pwr Type	MT Pwr Loc	IQ Pwr Type	IQ Mod Qty	IQ Pwr Loc	Power Color	Wood Feet Finish	Alum-inum Feet Finish	Moist Barr							
concealed glides shown 	MECH48L/CGL/NC	<input type="checkbox"/>	<input type="checkbox"/>	<input type="checkbox"/>	<input type="checkbox"/>	<input type="checkbox"/>	<input type="checkbox"/>	<input type="checkbox"/>	<input type="checkbox"/>	<input type="checkbox"/>	<input type="checkbox"/>	<input type="checkbox"/>	<input type="checkbox"/>				170.00#	\$ 3211	\$ 277
	MECH48L/PFT/NC	<input type="checkbox"/>	<input type="checkbox"/>	<input type="checkbox"/>	<input type="checkbox"/>	<input type="checkbox"/>	<input type="checkbox"/>	<input type="checkbox"/>	<input type="checkbox"/>	<input type="checkbox"/>	<input type="checkbox"/>	<input type="checkbox"/>	<input type="checkbox"/>				170.00#	3211	277
	MECH48L/WFT/NC	<input type="checkbox"/>	<input type="checkbox"/>	<input type="checkbox"/>	<input type="checkbox"/>	<input type="checkbox"/>	<input type="checkbox"/>	<input type="checkbox"/>	<input type="checkbox"/>	<input type="checkbox"/>	<input type="checkbox"/>	<input type="checkbox"/>	<input type="checkbox"/>				170.00#	3337	277
	MECH48L/AFT/NC	<input type="checkbox"/>	<input type="checkbox"/>	<input type="checkbox"/>	<input type="checkbox"/>	<input type="checkbox"/>	<input type="checkbox"/>	<input type="checkbox"/>	<input type="checkbox"/>	<input type="checkbox"/>	<input type="checkbox"/>	<input type="checkbox"/>	<input type="checkbox"/>				170.00#	3337	277

MEC48
Extended Corner LEFT with 48" High-Back - Non-contrast

- Non-contrast C.O.M = 6.5 yds
- Gangers included to gang to other High-Back models.
- Ganging to backless units or High-Back back to side ganging (specify kit separately)
- Does not gang with 32" Low-Back units
- Cannot be retrofitted to 60" model
- Power cannot be specified on front of unit on closed-end side. Three available power locations.
- All base models have foot leveling capacity
- Removable seat design, debris clean-out location, and painted wood base to protect against liquids.

Overall Dimensions:
• W=48" D=26" H=48"

Seat Dimensions:
• D=18.5" H=18"

HOW TO ORDER

Indicate the following information on order form:
1. Quantity of each item.
2. Model number, including options. See "How To Build a Model Number".
3. Any special service required.

Note: • The indicates that a choice is required.
• The absence of the indicates that no choice is required.
• Alpha-numeric characters in place of indicate that no other alternatives are available.

HOW TO BUILD A MODEL NUMBER

- A** Select basic model.
- B** Select non-contrast or fabric contrast 1. Refer to ki.com/fabrics.
 - For yardage pricing, see Fabric Yardage Pricing page
- C** Select power option.
 - NP** - No power
 - WP** - With power
- D** Select power type.
 - DCP** - Byrne Interlink IQ System w/Mini-Tap module OR jumper (Interlink IQ Infeed to power Interlink IQ Systems ordered separately)
 - RPT** - Mini-Tap power module w/3-prong plug; add \$314
- E** Select Mini-Tap® module w/3-prong plug location.
 - LRFP** - Left rear facing power
 - RFFP** - Right front facing power
 - RRFP** - Right rear facing power

- F** Select Byrne Interlink®IQ System type.
 - DCJ** - Byrne Interlink IQ System jumper only; add \$124
 - DSMOD** - Byrne Interlink IQ System w/Mini-Tap module
- G** Select Byrne Interlink®IQ System w/Mini-Tap® module quantity.
 - MOD1** - One module; add \$404
 - MOD2** - Two Modules; add \$807
 - MOD3** - Three modules; add \$1211
- H** Select Byrne Interlink®IQ System w/Mini-Tap® module location(s).
 - LRFP** - Left rear facing power
 - RFFP** - Right front facing power
 - RRFP** - Right rear facing power
 - LRRF** - Left rear, right front facing power
 - LRRR** - Left rear, right rear facing power
 - RRRF** - Right rear, right front facing power
 - RFLRRR** - Right front, left rear, right rear facing power
- I** Select power module color.
 - MPB** - Black power module

- MPS** - Silver power module
- MPW** - White power module
- J** Select wood feet finish. Refer to the **Product Color Options** page in this price list.
- K** Select brushed aluminum feet finish. Refer to the **Product Color Options** page in this price list.
- L** Select moisture barrier.
 - MB** - Moisture barrier
 - NMB** - No moisture barrier
 See pricing column for moisture barrier upcharge.

INFORMATION

The removable seat design of MyPlace™ High-Back units allows for ease of installation and clean out, as well as inspection of electrical components. MyPlace™ High-Back offers power modules with a 3-prong plug (ETL Listed) or Byrne Interlink® IQ electrical system (an ETL Listed Furniture Power Distribution Unit, electrical system.) Because the system is ETL Listed, MyPlace™ Lounge has not been listed. All 48" high-back models can be used as free-standing units or can be ganged to other 48" high-back or 60" high-back models. Gangers are included for traditional lineal ganging with 48" high-back models, however, please note installing concealed gangers on 48" high-back models will permanently alter upholstery. Please see Installation Guide for further information related to ganging.

SPECIAL SERVICES

Special Carton Marking

With specially marked information N/C

Shipping

Ships **assembled, FOB High Point, NC 27263, freight prepaid.** Freight class 250.

Specifications and prices are subject to change without prior notice.

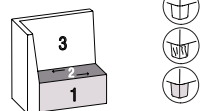

Features	MODEL NUMBER														Approx. Packaged Weight	Delivered Pricing	Moisture Barrier add to list price		
	Basic Model	Non-Cont or Fabric Cont 1	Fab Con 2	Fab Con 3	Pwr Opt	Pwr Type	MT Pwr Loc	IQ Pwr Type	IQ Mod Qty	IQ Pwr Loc	Power Color	Wood Feet Finish	Alum-inum Feet Finish	Moist Barr					
concealed glides shown 	Wood Feet	MECH48L/WFT/FC	<input type="checkbox"/>	<input type="checkbox"/>	<input type="checkbox"/>	<input type="checkbox"/>	<input type="checkbox"/>	<input type="checkbox"/>	<input type="checkbox"/>	<input type="checkbox"/>	<input type="checkbox"/>	<input type="checkbox"/>	<input type="checkbox"/>	<input type="checkbox"/>	<input type="checkbox"/>		170.00#	\$ 3397	\$ 277
	Concealed Glides	MECH48L/CGL/FC	<input type="checkbox"/>	<input type="checkbox"/>	<input type="checkbox"/>	<input type="checkbox"/>	<input type="checkbox"/>	<input type="checkbox"/>	<input type="checkbox"/>	<input type="checkbox"/>	<input type="checkbox"/>	<input type="checkbox"/>	<input type="checkbox"/>	<input type="checkbox"/>	<input type="checkbox"/>		170.00#	3270	277
	Poly Feet	MECH48L/PFT/FC	<input type="checkbox"/>	<input type="checkbox"/>	<input type="checkbox"/>	<input type="checkbox"/>	<input type="checkbox"/>	<input type="checkbox"/>	<input type="checkbox"/>	<input type="checkbox"/>	<input type="checkbox"/>	<input type="checkbox"/>	<input type="checkbox"/>	<input type="checkbox"/>	<input type="checkbox"/>		170.00#	3270	277
	Aluminum Feet	MECH48L/AFT/FC	<input type="checkbox"/>	<input type="checkbox"/>	<input type="checkbox"/>	<input type="checkbox"/>	<input type="checkbox"/>	<input type="checkbox"/>	<input type="checkbox"/>	<input type="checkbox"/>	<input type="checkbox"/>	<input type="checkbox"/>	<input type="checkbox"/>	<input type="checkbox"/>	<input type="checkbox"/>		170.00#	3397	277

MEC48
Extended Corner LEFT with 48" High-Back - Contrast

- 1 = Base (Contrast 1) C.O.M. = 2 yd
- 2 = Seat (Contrast 2) C.O.M. = .75 yd
- 3 = Back (Contrast 3) C.O.M. = 5 yd
- Gangers included to gang to other High-Back models.
- Ganging to backless units or High-Back back to side ganging (specify kit separately)
- Does not gang with 32" Low-Back units
- Cannot be retrofitted to 60" model
- Power cannot be specified on front of unit on closed-end side. Three available power locations.
- All base models have foot leveling capacity
- Removable seat design, debris clean-out location, and painted wood base to protect against liquids.

Overall Dimensions:
• W=48" D=26" H=48"

Seat Dimensions:
• D=18.5" H=18"

HOW TO ORDER

Indicate the following information on order form:

1. Quantity of each item.
2. Model number, including options. See "How To Build a Model Number".
3. Any special service required.

Note: • The indicates that a choice is required.
• The absence of the indicates that no choice is required.
• Alpha-numeric characters in place of indicate that no other alternatives are available.

HOW TO BUILD A MODEL NUMBER

A Select basic model.

B Select non-contrast or fabric contrast 1. Refer to ki.com/fabrics.
• For yardage pricing, see Fabric Yardage Pricing page

C Select fabric contrast 2. Refer to ki.com/fabrics.
• For yardage pricing, see Fabric Yardage Pricing page

D Select fabric contrast 3. Refer to ki.com/fabrics.
• For yardage pricing, see Fabric Yardage Pricing page

E Select power option.
NP - No power
WP - With power

F Select power type.
DCP - Byrne Interlink IQ System w/Mini-Tap module OR jumper (Interlink IQ Infeed to power Interlink IQ Systems ordered separately)
RPT - Mini-Tap power module w/3-prong plug; add \$314

G Select Mini-Tap® module w/3-prong plug location.
LRFP - Left rear facing power
RFFP - Right front facing power
RRFP - Right rear facing power

H Select Byrne Interlink®IQ System type.
DCJ - Byrne Interlink IQ System jumper only; add \$124
DSMOD - Byrne Interlink IQ System w/Mini-Tap module

I Select Byrne Interlink®IQ System w/Mini-Tap® module quantity.
MOD1 - One module; add \$404
MOD2 - Two Modules; add \$807
MOD3 - Three modules; add \$1211

J Select Byrne Interlink®IQ System w/Mini-Tap® module location(s).
LRFP - Left rear facing power

K Select power module color.
MPB - Black power module
MPS - Silver power module
MPW - White power module

L Select wood feet finish. Refer to the **Product Color Options** page in this price list.

M Select brushed aluminum feet finish. Refer to the **Product Color Options** page in this price list.

N Select moisture barrier.
MB - Moisture barrier
NMB - No moisture barrier
See pricing column for moisture barrier upcharge.

INFORMATION

The removable seat design of MyPlace™ High-Back units allows for ease of installation and clean out, as well as inspection of electrical components. MyPlace™ High-Back offers power modules with a 3-prong plug (ETL Listed) or Byrne Interlink® IQ electrical system (an ETL Listed Furniture Power Distribution Unit, electrical system.) Because the system is ETL Listed, MyPlace™ Lounge has not been listed. All 48" high-back models can be used as free-standing units or can be ganged to other 48" high-back or 60" high-back models. Gangers are included for traditional lineal ganging with 48" high-back models, however, please note installing concealed gangers on 48" high-back models will permanently alter upholstery. Please see Installation Guide for further information related to ganging.

SPECIAL SERVICES

Special Carton Marking
With specially marked information N/C

Shipping
Ships **assembled, FOB High Point, NC 27263, freight prepaid.** Freight class 250.

Specifications and prices are subject to change without prior notice.

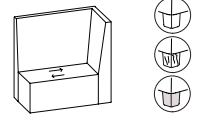

Features	MODEL NUMBER													Approx. Packaged Weight	Delivered Pricing	Moisture Barrier add to list price			
	Basic Model	Non-Cont or Fabric Cont 1	Pwr Opt	Pwr Type	MT Pwr Loc	IQ Pwr Type	IQ Mod Qty	IQ Pwr Loc	Power Color	Wd Feet Fin	Alum Feet Fin	Moist Barr							
concealed glides shown 	Concealed Glides	MECH48R/CGL/NC	<input type="checkbox"/>	<input type="checkbox"/>	<input type="checkbox"/>	<input type="checkbox"/>	<input type="checkbox"/>	<input type="checkbox"/>	<input type="checkbox"/>	<input type="checkbox"/>	<input type="checkbox"/>	<input type="checkbox"/>	<input type="checkbox"/>				170.00#	\$ 3211	\$ 277
	Poly Feet	MECH48R/PFT/NC	<input type="checkbox"/>	<input type="checkbox"/>	<input type="checkbox"/>	<input type="checkbox"/>	<input type="checkbox"/>	<input type="checkbox"/>	<input type="checkbox"/>	<input type="checkbox"/>	<input type="checkbox"/>	<input type="checkbox"/>	<input type="checkbox"/>				170.00#	3211	277
	Wood Feet	MECH48R/WFT/NC	<input type="checkbox"/>	<input type="checkbox"/>	<input type="checkbox"/>	<input type="checkbox"/>	<input type="checkbox"/>	<input type="checkbox"/>	<input type="checkbox"/>	<input type="checkbox"/>	<input type="checkbox"/>	<input type="checkbox"/>	<input type="checkbox"/>				170.00#	3337	277
	Aluminum Feet	MECH48R/AFT/NC	<input type="checkbox"/>	<input type="checkbox"/>	<input type="checkbox"/>	<input type="checkbox"/>	<input type="checkbox"/>	<input type="checkbox"/>	<input type="checkbox"/>	<input type="checkbox"/>	<input type="checkbox"/>	<input type="checkbox"/>	<input type="checkbox"/>				170.00#	3337	277

MEC48
Extended Corner RIGHT with 48" High-Back - Non-contrast

- Non-contrast C.O.M = 6.5 yds
- Gangers included to gang to other High-Back models.
- Ganging to backless units or High-Back back to side ganging (specify kit separately)
- Does not gang with 32" Low-Back units
- Cannot be retrofitted to 60" model
- Power cannot be specified on front of unit on closed-end side. Three available power locations.
- All base models have foot leveling capacity
- Removable seat design, debris clean-out location, and painted wood base to protect against liquids.

Overall Dimensions:
• W=48" D=26" H=48"

Seat Dimensions:
• D=18.5" H=18"

HOW TO ORDER

Indicate the following information on order form:
1. Quantity of each item.
2. Model number, including options. See "How To Build a Model Number".
3. Any special service required.

Note: • The indicates that a choice is required.
• The absence of the indicates that no choice is required.
• Alpha-numeric characters in place of indicate that no other alternatives are available.

HOW TO BUILD A MODEL NUMBER

- A** Select basic model.
- B** Select non-contrast or fabric contrast 1. Refer to ki.com/fabrics.
• For yardage pricing, see Fabric Yardage Pricing page
- C** Select power option.
NP - No power
WP - With power
- D** Select power type.
DCP - Byrne Interlink IQ System w/Mini-Tap module OR jumper (Interlink IQ Infeed to power Interlink IQ Systems ordered seperately)
RPT - Mini-Tap power module w/3-prong plug; add \$314
- E** Select Mini-Tap® module w/3-prong plug location.
LFFP - Left front facing power
LRFP - Left rear facing power
RRFP - Right rear facing power
- F** Select Byrne Interlink®IQ System type.
DCJ - Byrne Interlink IQ System jumper only; add

- \$124
DSMOD - Byrne Interlink IQ System w/Mini-Tap module
- G** Select Byrne Interlink®IQ System w/Mini-Tap® module quantity.
MOD1 - One module; add \$404
MOD2 - Two Modules; add \$807
MOD3 - Three modules; add \$1211
- H** Select Byrne Interlink®IQ System w/Mini-Tap® module location(s).
LFFP - Left front facing power
LRFP - Left rear facing power
RRFP - Right rear facing power
LFLR - Left front, left rear facing power
LFRR - Left front, right rear facing power
LRRR - Left rear, right rear facing power
LFLRRR - Left front, left rear, right rear facing power
- I** Select power module color.
MPB - Black power module
MPS - Silver power module
MPW - White power module
- J** Select wood feet finish. Refer to the **Product Color Options** page in this price list.

- K** Select brushed aluminum feet finish. Refer to the **Product Color Options** page in this price list.
- L** Select moisture barrier.
MB - Moisture barrier
NMB - No moisture barrier
See pricing column for moisture barrier upcharge.

INFORMATION

The removable seat design of MyPlace™ High-Back units allows for ease of installation and clean out, as well as inspection of electrical components. MyPlace™ High-Back offers power modules with a 3-prong plug (ETL Listed) or Byrne Interlink® IQ electrical system (an ETL Listed Furniture Power Distribution Unit, electrical system.) Because the system is ETL Listed, MyPlace™ Lounge has not been listed. All 48" high-back models can be used as free-standing units or can be ganged to other 48" high-back or 60" high-back models. Gangers are included for traditional lineal ganging with 48" high-back models, however, please note installing concealed gangers on 48" high-back models will permanently alter upholstery. Please see Installation Guide for further information related to ganging.

SPECIAL SERVICES

Special Carton Marking

With specially marked information N/C

Shipping
Ships **assembled, FOB High Point, NC 27263, freight prepaid.** Freight class 250.

Specifications and prices are subject to change without prior notice.



Features	MODEL NUMBER														Approx. Packaged Weight	Delivered Pricing	Moisture Barrier add to list price		
	Basic Model	Non-Cont or Fabric Cont 1	Fab Con 2	Fab Con 3	Pwr Opt	Pwr Type	MT Pwr Loc	IQ Pwr Type	IQ Mod Qty	IQ Pwr Loc	Power Color	Wd Feet Fin	Alum Feet Fin	Moist Barr					
concealed glides shown	Concealed Glides	MECH48R/CGL/FC	<input type="checkbox"/>	<input type="checkbox"/>	<input type="checkbox"/>	<input type="checkbox"/>	<input type="checkbox"/>	<input type="checkbox"/>	<input type="checkbox"/>	<input type="checkbox"/>	<input type="checkbox"/>	<input type="checkbox"/>	<input type="checkbox"/>	<input type="checkbox"/>	<input type="checkbox"/>	<input type="checkbox"/>	170.00#	\$ 3270	\$ 277
	Poly Feet	MECH48R/PFT/FC	<input type="checkbox"/>	<input type="checkbox"/>	<input type="checkbox"/>	<input type="checkbox"/>	<input type="checkbox"/>	<input type="checkbox"/>	<input type="checkbox"/>	<input type="checkbox"/>	<input type="checkbox"/>	<input type="checkbox"/>	<input type="checkbox"/>	<input type="checkbox"/>	<input type="checkbox"/>	<input type="checkbox"/>	170.00#	3270	277
	Wood Feet	MECH48R/WFT/FC	<input type="checkbox"/>	<input type="checkbox"/>	<input type="checkbox"/>	<input type="checkbox"/>	<input type="checkbox"/>	<input type="checkbox"/>	<input type="checkbox"/>	<input type="checkbox"/>	<input type="checkbox"/>	<input type="checkbox"/>	<input type="checkbox"/>	<input type="checkbox"/>	<input type="checkbox"/>	<input type="checkbox"/>	170.00#	3397	277
	Aluminum Feet	MECH48R/AFT/FC	<input type="checkbox"/>	<input type="checkbox"/>	<input type="checkbox"/>	<input type="checkbox"/>	<input type="checkbox"/>	<input type="checkbox"/>	<input type="checkbox"/>	<input type="checkbox"/>	<input type="checkbox"/>	<input type="checkbox"/>	<input type="checkbox"/>	<input type="checkbox"/>	<input type="checkbox"/>	<input type="checkbox"/>	170.00#	3397	277

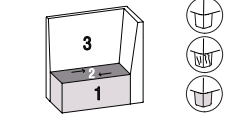

MEC48

Extended Corner RIGHT with 48" High-Back - Contrast

- 1 = Base (Contrast 1) C.O.M. = 2 yd
- 2 = Seat (Contrast 2) C.O.M. = .75 yd
- 3 = Back (Contrast 3) C.O.M. = 5 yd
- Gangers included to gang to other High-Back models.
- Ganging to backless units or High-Back back to side ganging (specify kit separately)
- Does not gang with 32" Low-Back units
- Cannot be retrofitted to 60" model
- Power cannot be specified on front of unit on closed-end side. Three available power locations.
- All base models have foot leveling capacity
- Removable seat design, debris clean-out location, and painted wood base to protect against liquids.

Overall Dimensions:

- W=48" D=26" H=48"

Seat Dimensions:

- D=18.5" H=18"

HOW TO ORDER

Indicate the following information on order form:

- Quantity of each item.
- Model number, including options. See "How To Build a Model Number".
- Any special service required.

Note: • The indicates that a choice is required.

- The absence of the indicates that no choice is required.
- Alpha-numeric characters in place of indicate that no other alternatives are available.

HOW TO BUILD A MODEL NUMBER

- A** Select basic model.
- B** Select non-contrast or fabric contrast 1.
Refer to ki.com/fabrics.
• For yardage pricing, see Fabric Yardage Pricing page
- C** Select fabric contrast 2.
Refer to ki.com/fabrics.
• For yardage pricing, see Fabric Yardage Pricing page
- D** Select fabric contrast 3.
Refer to ki.com/fabrics.
• For yardage pricing, see Fabric Yardage Pricing page
- E** Select power option.
NP - No power
WP - With power
- F** Select power type.
DCP - Byrne Interlink IQ System w/Mini-Tap module OR jumper (Interlink IQ infeed to power Interlink IQ Systems ordered separately)
RPT - Mini-Tap power module w/3-prong plug;

- add \$314
- G** Select Mini-Tap® module w/3-prong plug location.
LFFP - Left front facing power
LRFP - Left rear facing power
RRFP - Right rear facing power
- H** Select Byrne Interlink®IQ System type.
DCJ - Byrne Interlink IQ System jumper only; add \$124
DSMOD - Byrne Interlink IQ System w/Mini-Tap module
- I** Select Byrne Interlink®IQ System w/Mini-Tap® module location(s).
MOD1 - One module; add \$404
MOD2 - Two Modules; add \$807
MOD3 - Three modules; add \$1211
- J** Select Byrne Interlink®IQ System w/Mini-Tap® module location(s).
LFFP - Left front facing power
LRFP - Left rear facing power
RRFP - Right rear facing power
LFLR - Left front, left rear facing power

- LFRR** - Left front, right rear facing power
LRRR - Left rear, right rear facing power
LFLRRR - Left front, left rear, right rear facing power
- K** Select power module color.
MPB - Black power module
MPS - Silver power module
MPW - White power module
- L** Select wood feet finish.
Refer to the **Product Color Options** page in this price list.
- M** Select brushed aluminum feet finish.
Refer to the **Product Color Options** page in this price list.
- N** Select moisture barrier.
MB - Moisture barrier
NMB - No moisture barrier
See pricing column for moisture barrier upcharge.

INFORMATION

The removable seat design of MyPlace™ High-Back units allows for ease of installation and clean out, as well as inspection of electrical components. MyPlace™ High-Back offers power modules with a 3-prong plug (ETL Listed) or Byrne Interlink® IQ electrical system (an ETL Listed Furniture Power Distribution Unit, electrical system.) Because the system is ETL Listed, MyPlace™ Lounge has not been listed. All 48" high-back models can be used as free-standing units or can be ganged to other 48" high-back or 60" high-back models. Gangers are included for traditional lineal ganging with 48" high-back models, however, please note installing concealed gangers on 48" high-back models will permanently alter upholstery. Please see Installation Guide for further information related to ganging.

SPECIAL SERVICES
Special Carton Marking

With specially marked information N/C

Shipping
Ships **assembled, FOB High Point, NC 27263, freight prepaid.** Freight class 250.

Specifications and prices are subject to change without prior notice.



Features	MODEL NUMBER								Approx. Packaged Weight	Delivered Pricing	Moisture Barrier add to list price	
	Basic Model	Non-Contrast or Fabric Contrast 1	Fabric Contrast 2	Fabric Contrast 3	Power Option	Wood Feet Finish	Aluminum Feet Finish	Moisture Barrier				
concealed glides shown	Concealed Glides	MCNH48L/CGL/FC	<input type="checkbox"/>	<input type="checkbox"/>	<input type="checkbox"/>	<input type="checkbox"/>			<input type="checkbox"/>	125.00#	\$ 2645	\$ 248
	Poly Feet	MCNH48L/PFT/FC	<input type="checkbox"/>	<input type="checkbox"/>	<input type="checkbox"/>	<input type="checkbox"/>			<input type="checkbox"/>	125.00#	2645	248
	Wood Feet	MCNH48L/WFT/FC	<input type="checkbox"/>	<input type="checkbox"/>	<input type="checkbox"/>	<input type="checkbox"/>	<input type="checkbox"/>		<input type="checkbox"/>	125.00#	2774	248
	Aluminum Feet	MCNH48L/AFT/FC	<input type="checkbox"/>	<input type="checkbox"/>	<input type="checkbox"/>	<input type="checkbox"/>		<input type="checkbox"/>	<input type="checkbox"/>	125.00#	2774	248
<p>MCN48</p> <p>Corner LEFT with 48" High-Back - Contrast</p> <ul style="list-style-type: none"> • 1 = Base (Contrast 1) C.O.M. = 1.5 yd • 2 = Seat (Contrast 2) C.O.M. = .75 yd • 3 = Back (Contrast 3) C.O.M. = 3.75 yd • Gangers included to gang to other High-Back models. • Ganging to backless units or High-Back back to side ganging (specify kit separately) • Does not gang with 32" Low-Back units • Cannot be retrofitted to 60" model • No Mini-Tap® power options • Byrne Interlink®IQ power only available as a pass-through jumper • All base models have foot leveling capacity • Removable seat design, debris clean-out location, and painted wood base to protect against liquids. • Overall Dimensions: <ul style="list-style-type: none"> • W=26" D=26" H=48" • Seat Dimensions: <ul style="list-style-type: none"> • D=18.5" H=18" 												
			A	B	C	D	E	F	G	H		

HOW TO ORDER

- Indicate the following information on order form:
1. Quantity of each item.
 2. Model number, including options. See "How To Build a Model Number".
 3. Any special service required.

Note: • The indicates that a choice is required.

- The absence of the indicates that no choice is required.
- Alpha-numeric characters in place of indicate that no other alternatives are available.

HOW TO BUILD A MODEL NUMBER

- A** Select basic model.
- B** Select non-contrast or fabric contrast 1. Refer to ki.com/fabrics.
 - For yardage pricing, see Fabric Yardage Pricing page
- C** Select fabric contrast 2. Refer to ki.com/fabrics
 - For yardage pricing, see Fabric Yardage Pricing page
- D** Select fabric contrast 3. Refer to ki.com/fabrics
 - For yardage pricing, see Fabric Yardage Pricing page
- E** Select power option.
 - DCJ** - Byrne Interlink IQ System jumper only; add \$124
 - NP** - No power
- F** Select wood feet finish.

Refer to the **Product Color Options** page in this price list.

- G** Select brushed aluminum feet finish. Refer to the **Product Color Options** page in this price list.
- H** Select moisture barrier.
 - MB** - Moisture barrier
 - NMB** - No moisture barrier

See pricing column for moisture barrier upcharge.

INFORMATION

The removable seat design of MyPlace™ High-Back units allows for ease of installation and clean out, as well as inspection of electrical components. MyPlace™ High-Back offers power modules with a 3-prong plug (ETL Listed) or Byrne Interlink® IQ electrical system (an ETL Listed Furniture Power Distribution Unit, electrical system.) Because the system is ETL Listed, MyPlace™ Lounge has not been listed. All 48" high-back models can be used as free-standing units or can be ganged to other 48" high-back or 60" high-back models. Gangers are included for traditional lineal ganging with 48" high-back models, however, please note installing concealed gangers on 48" high-back models will permanently alter upholstery. Please see Installation Guide for further information related to ganging.

SPECIAL SERVICES

Special Carton Marking

With specially marked information N/C

Shipping
Ships **assembled, FOB High Point, NC 27263, freight prepaid.** Freight class 250.

Specifications and prices are subject to change without prior notice.



Features	MODEL NUMBER													Approx. Packaged Weight	Delivered Pricing	Moisture Barrier add to list price
	Basic Model	Non-Cont or Fabric Cont 1	Pwr Opt	Pwr Type	MT Pwr Loc	IQ Pwr Type	IQ Mod Qty	IQ Pwr Loc	Pwr Color	Wd Feet Fin	Alum Feet Fin	Moist Barr				
concealed glides shown	Concealed Glide	MCIH44/CGL/NC	<input type="checkbox"/>	<input type="checkbox"/>	<input type="checkbox"/>	<input type="checkbox"/>	<input type="checkbox"/>	<input type="checkbox"/>	<input type="checkbox"/>	<input type="checkbox"/>	<input type="checkbox"/>	<input type="checkbox"/>	<input type="checkbox"/>	122.00#	\$ 2306	\$ 248
	Poly Feet	MCIH44/PFT/NC	<input type="checkbox"/>	<input type="checkbox"/>	<input type="checkbox"/>	<input type="checkbox"/>	<input type="checkbox"/>	<input type="checkbox"/>	<input type="checkbox"/>	<input type="checkbox"/>	<input type="checkbox"/>	<input type="checkbox"/>	<input type="checkbox"/>	122.00#	2306	248
	Wood Feet	MCIH44/WFT/NC	<input type="checkbox"/>	<input type="checkbox"/>	<input type="checkbox"/>	<input type="checkbox"/>	<input type="checkbox"/>	<input type="checkbox"/>	<input type="checkbox"/>	<input type="checkbox"/>	<input type="checkbox"/>	<input type="checkbox"/>	<input type="checkbox"/>	122.00#	2432	248
	Aluminum Feet	MCIH44/AFT/NC	<input type="checkbox"/>	<input type="checkbox"/>	<input type="checkbox"/>	<input type="checkbox"/>	<input type="checkbox"/>	<input type="checkbox"/>	<input type="checkbox"/>	<input type="checkbox"/>	<input type="checkbox"/>	<input type="checkbox"/>	<input type="checkbox"/>	122.00#	2432	248
MCI44																
Inside Back, 45° Curve, 48" High-Back - Non-contrast																
<ul style="list-style-type: none"> • Non-contrast C.O.M = 4.75 yds • Gangers included to gang to other High-Back models. • Ganging to backless units or High-Back back to side ganging (specify kit separately) • Does not gang with 32" Low-Back units • Cannot be retrofitted to 60" model • All base models have foot leveling capacity • Removable seat design, debris clean-out location, and painted wood base to protect against liquids. • Overall Dimensions: • W=41.5" D=26" H=48" Seat Dimensions: • D=18.5" H=18" 																
A B C D E F G H I J K L																

HOW TO ORDER

- Indicate the following information on order form:
1. Quantity of each item.
 2. Model number, including options. See "How To Build a Model Number".
 3. Any special service required.

Note: • The indicates that a choice is required.
 • The absence of the indicates that no choice is required.
 • Alpha-numeric characters in place of indicate that no other alternatives are available.

HOW TO BUILD A MODEL NUMBER

- A** Select basic model.
- B** Select non-contrast or fabric contrast 1. Refer to ki.com/fabrics.
 • For yardage pricing, see Fabric Yardage Pricing page
- C** Select power option.
NP - No power
WP - With power
- D** Select power type.
DCP - Byrne Interlink IQ System w/Mini-Tap module OR jumper (Interlink IQ Infeed to power Interlink IQ Systems ordered separately)
RPT - Mini-Tap power module w/3-prong plug; add \$314
- E** Select Mini-Tap® module w/3-prong plug location.
LFFP - Left front facing power
LRFP - Left rear facing power
RFFP - Right front facing power
RRFP - Right rear facing power

- F** Select Byrne Interlink®IQ System type.
DCJ - Byrne Interlink IQ System jumper only; add \$124
DSMOD - Byrne Interlink IQ System w/Mini-Tap module
- G** Select Byrne Interlink®IQ System w/Mini-Tap® module quantity.
MOD1 - One module; add \$404
MOD2 - Two Modules; add \$807
MOD3 - Three modules; add \$1211
MOD4 - Four modules; add \$1614
- H** Select Byrne Interlink®IQ System w/Mini-Tap® module location(s).
LFFP - Left front facing power
LRFP - Left rear facing power
RFFP - Right front facing power
RRFP - Right rear facing power
LFLR - Left front, left rear facing power
LFRF - Left front, right front facing power
LFRR - Left front, right rear facing power
LRRF - Left rear, right front facing power
LRRR - Left rear, right rear facing power
RRRF - Right rear, right front facing power
RFLRRR - Left front, left rear, right rear facing power
LFRFLR - Left front, right front, left rear facing power
LFRFRR - Left front, right front, right rear facing power
RFLRRR - Right front, left rear, right rear facing power

- LFRFLRRR** - Left front, right front, left rear, right rear facing power
- I** Select power module color.
MPB - Black power module
MPS - Silver power module
MPW - White power module
- J** Select wood feet finish. Refer to the **Product Color Options** page in this price list.
- K** Select brushed aluminum feet finish. Refer to the **Product Color Options** page in this price list.
- L** Select moisture barrier.
MB - Moisture barrier
NMB - No moisture barrier
 See pricing column for moisture barrier upcharge.

INFORMATION

The removable seat design of MyPlace™ High-Back units allows for ease of installation and clean out, as well as inspection of electrical components. MyPlace™ High-Back offers power modules with a 3-prong plug (ETL Listed) or Byrne Interlink® IQ electrical system (an ETL Listed Furniture Power Distribution Unit, electrical system.) Because the system is ETL Listed, MyPlace™ Lounge has not been listed. All 48" high-back models can be used as free-standing units or can be ganged to other 48" high-back or 60" high-back models. Gangers are included for traditional lineal ganging with 48" high-back models, however, please note installing concealed gangers on 48" high-back models will permanently alter upholstery. Please see Installation Guide for further information related to ganging.

SPECIAL SERVICES

Special Carton Marking

With specially marked information N/C

Shipping
 Ships **assembled, FOB High Point, NC 27263, freight prepaid.** Freight class 250.

Specifications and prices are subject to change without prior notice.



Features	MODEL NUMBER														Approx. Packaged Weight	Delivered Pricing	Moisture Barrier add to list price			
	Basic Model	Non-Cont or Fabric Cont 1	Fab Con 2	Fab Con 3	Pwr Opt	Pwr Type	MT Pwr Loc	IQ Pwr Type	IQ Mod Qty	IQ Pwr Loc	Pwr Color	Wd Feet Fin	Alum Feet Fin	Moist Barr						
concealed glides shown	Concealed Glide	MCIH44/CGL/FC	<input type="checkbox"/>	<input type="checkbox"/>	<input type="checkbox"/>	<input type="checkbox"/>	<input type="checkbox"/>	<input type="checkbox"/>	<input type="checkbox"/>	<input type="checkbox"/>	<input type="checkbox"/>	<input type="checkbox"/>	<input type="checkbox"/>	<input type="checkbox"/>	<input type="checkbox"/>			122.00#	\$ 2348	\$ 248
	Poly Feet	MCIH44/PFT/FC	<input type="checkbox"/>	<input type="checkbox"/>	<input type="checkbox"/>	<input type="checkbox"/>	<input type="checkbox"/>	<input type="checkbox"/>	<input type="checkbox"/>	<input type="checkbox"/>	<input type="checkbox"/>	<input type="checkbox"/>	<input type="checkbox"/>	<input type="checkbox"/>	<input type="checkbox"/>			122.00#	2348	248
	Wood Feet	MCIH44/WFT/FC	<input type="checkbox"/>	<input type="checkbox"/>	<input type="checkbox"/>	<input type="checkbox"/>	<input type="checkbox"/>	<input type="checkbox"/>	<input type="checkbox"/>	<input type="checkbox"/>	<input type="checkbox"/>	<input type="checkbox"/>	<input type="checkbox"/>	<input type="checkbox"/>	<input type="checkbox"/>			122.00#	2475	248
	Aluminum Feet	MCIH44/AFT/FC	<input type="checkbox"/>	<input type="checkbox"/>	<input type="checkbox"/>	<input type="checkbox"/>	<input type="checkbox"/>	<input type="checkbox"/>	<input type="checkbox"/>	<input type="checkbox"/>	<input type="checkbox"/>	<input type="checkbox"/>	<input type="checkbox"/>	<input type="checkbox"/>	<input type="checkbox"/>			122.00#	2475	248
MCI44																				
Inside Back, 45° Curve, 48" High-Back - Contrast																				
<ul style="list-style-type: none"> • 1 = Base (Contrast 1) C.O.M. = 1.25 yd • 2 = Seat (Contrast 2) C.O.M. = .75 yd • 3 = Back (Contrast 3) C.O.M. = 3.25 yd • Gangers included to gang to other High-Back models. • Ganging to backless units or High-Back back to side ganging (specify kit separately) • Does not gang with 32" Low-Back units • Cannot be retrofitted to 60" model • All base models have foot leveling capacity • Removable seat design, debris clean-out location, and painted wood base to protect against liquids. • Overall Dimensions: <ul style="list-style-type: none"> • W=41.5" D=26" H=48" • Seat Dimensions: <ul style="list-style-type: none"> • D=18.5" H=18" 																				
A B C D E F G H I J K L M N																				

HOW TO ORDER

- Indicate the following information on order form:
- Quantity of each item.
 - Model number, including options. See "How To Build a Model Number".
 - Any special service required.

- Note:
- The indicates that a choice is required.
 - The absence of the indicates that no choice is required.
 - Alpha-numeric characters in place of indicate that no other alternatives are available.

HOW TO BUILD A MODEL NUMBER

- A** Select basic model.
- B** Select non-contrast or fabric contrast 1. Refer to ki.com/fabrics.
• For yardage pricing, see Fabric Yardage Pricing page
- C** Select fabric contrast 2. Refer to ki.com/fabrics.
• For yardage pricing, see Fabric Yardage Pricing page
- D** Select fabric contrast 3. Refer to ki.com/fabrics.
• For yardage pricing, see Fabric Yardage Pricing page
- E** Select power option.
NP - No power
WP - With power
- F** Select power type.
DCP - Byrne Interlink IQ System w/Mini-Tap module OR jumper (Interlink IQ Infeed to power Interlink IQ Systems ordered seperately)
RPT - Mini-Tap power module w/3-prong plug; add \$314

- G** Select Mini-Tap® module w/3-prong plug location.
LFPP - Left front facing power
LRFP - Left rear facing power
RFFP - Right front facing power
RRFP - Right rear facing power
- H** Select Byrne Interlink®IQ System type.
DCJ - Byrne Interlink IQ System jumper only; add \$124
DSMOD - Byrne Interlink IQ System w/Mini-Tap module
- I** Select Byrne Interlink®IQ System w/Mini-Tap® module quantity.
MOD1 - One module; add \$404
MOD2 - Two Modules; add \$807
MOD3 - Three modules; add \$1211
MOD4 - Four modules; add \$1614
- J** Select Byrne Interlink®IQ System w/Mini-Tap® module location(s).
LFPP - Left front facing power
LRFP - Left rear facing power
RFFP - Right front facing power
RRFP - Right rear facing power
LFLR - Left front, left rear facing power
LFRF - Left front, right front facing power
LFRR - Left front, right rear facing power

- LRRF** - Left rear, right front facing power
LRRR - Left rear, right rear facing power
RRRF - Right rear, right front facing power
LFLRRR - Left front, left rear, right rear facing power
LFRFLR - Left front, right front, left rear facing power
LFRFRR - Left front, right front, right rear facing power
RFLRRR - Right front, left rear, right rear facing power
LFRFLRRR - Left front, right front, left rear, right rear facing power
- K** Select power module color.
MPB - Black power module
MPS - Silver power module
MPW - White power module
- L** Select wood feet finish. Refer to the **Product Color Options** page in this price list.
- M** Select brushed aluminum feet finish. Refer to the **Product Color Options** page in this price list.
- N** Select moisture barrier.
MB - Moisture barrier
NMB - No moisture barrier
See pricing column for moisture barrier upcharge.

INFORMATION

The removable seat design of MyPlace™ High-Back units allows for ease of installation and clean out, as well as inspection of electrical components. MyPlace™ High-Back offers power modules with a 3-prong plug (ETL Listed) or Byrne Interlink® IQ electrical system (an ETL Listed Furniture Power Distribution Unit, electrical system.) Because the system is ETL Listed, MyPlace™ Lounge has not been listed. All 48" high-back models can be used as free-standing units or can be ganged to other 48" high-back or 60" high-back models. Gangers are included for traditional lineal ganging with 48" high-back models, however, please note installing concealed gangers on 48" high-back models will permanently alter upholstery. Please see Installation Guide for further information related to ganging.

SPECIAL SERVICES

Special Carton Marking

With specially marked information N/C

Shipping

Ships assembled, FOB High Point, NC 27263, freight prepaid. Freight class 250.

Specifications and prices are subject to change without prior notice.

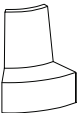

Features	MODEL NUMBER													Approx. Packaged Weight	Delivered Pricing	Moisture Barrier add to list price		
	Basic Model	Non-Cont or Fabric Cont 1	Pwr Opt	Pwr Type	MT Pwr Loc	IQ Pwr Type	IQ Mod Qty	IQ Pwr Loc	Power Color	Wood Feet Finish	Alum-inum Feet Finish	Moist Barr						
concealed glides shown 	Concealed Glide	MCOH44/CGL/NC	<input type="checkbox"/>	<input type="checkbox"/>	<input type="checkbox"/>	<input type="checkbox"/>	<input type="checkbox"/>	<input type="checkbox"/>	<input type="checkbox"/>	<input type="checkbox"/>	<input type="checkbox"/>	<input type="checkbox"/>	<input type="checkbox"/>	<input type="checkbox"/>				\$ 238
	Poly Feet	MCOH44/PFT/NC	<input type="checkbox"/>	<input type="checkbox"/>	<input type="checkbox"/>	<input type="checkbox"/>	<input type="checkbox"/>	<input type="checkbox"/>	<input type="checkbox"/>	<input type="checkbox"/>	<input type="checkbox"/>	<input type="checkbox"/>	<input type="checkbox"/>	<input type="checkbox"/>				238
	Wood Feet	MCOH44/WFT/NC	<input type="checkbox"/>	<input type="checkbox"/>	<input type="checkbox"/>	<input type="checkbox"/>	<input type="checkbox"/>	<input type="checkbox"/>	<input type="checkbox"/>	<input type="checkbox"/>	<input type="checkbox"/>	<input type="checkbox"/>	<input type="checkbox"/>	<input type="checkbox"/>				238
	Aluminum Feet	MCOH44/AFT/NC	<input type="checkbox"/>	<input type="checkbox"/>	<input type="checkbox"/>	<input type="checkbox"/>	<input type="checkbox"/>	<input type="checkbox"/>	<input type="checkbox"/>	<input type="checkbox"/>	<input type="checkbox"/>	<input type="checkbox"/>	<input type="checkbox"/>	<input type="checkbox"/>				238

A
B
C
D
E
F
G
H
I
J
K
L

MCO44

Outside Back, 45° Curve, 48" High-Back - Non-contrast

- Non-contrast C.O.M = 4 yds
- Gangers included to gang to other High-Back models.
- Ganging to backless units or High-Back back to side ganging (specify kit separately)
- Does not gang with 32" Low-Back units
- Cannot be retrofitted to 60" model
- All base models have foot leveling capacity
- Removable seat design, debris clean-out location, and painted wood base to protect against liquids.
- Overall Dimensions:
- W=41.5" D=26" H=48"
- Seat Dimensions:
- D=18.5" H=18"

HOW TO ORDER

Indicate the following information on order form:

1. Quantity of each item.
2. Model number, including options. See "How To Build a Model Number".
3. Any special service required.

Note:

- The indicates that a choice is required.
- The absence of the indicates that no choice is required.
- Alpha-numeric characters in place of indicate that no other alternatives are available.

HOW TO BUILD A MODEL NUMBER

A Select basic model.

B Select non-contrast or fabric contrast 1. Refer to [ki.com/fabrics](#).
• For yardage pricing, see Fabric Yardage Pricing page

C Select power option.
NP - No power
WP - With power

D Select power type.
DCP - Byrne Interlink IQ System w/Mini-Tap module OR jumper (Interlink IQ Infeed to power Interlink IQ Systems ordered separately)
RPT - Mini-Tap power module w/3-prong plug; add \$314

E Select Mini-Tap® module w/3-prong plug location.
LFPP - Left front facing power
LRFP - Left rear facing power
RFFP - Right front facing power
RRFP - Right rear facing power

F Select Byrne Interlink®IQ System type.
DCJ - Byrne Interlink IQ System jumper only; add \$12.
DSMOD - Byrne Interlink IQ System w/Mini-Tap module

G Select Byrne Interlink®IQ System w/Mini-Tap® module quantity.
MOD1 - One module; add \$404
MOD2 - Two Modules; add \$807
MOD3 - Three modules; add \$1211
MOD4 - Four modules; add \$1614

H Select Byrne Interlink®IQ System w/Mini-Tap® module location(s).
LFPP - Left front facing power
LRFP - Left rear facing power
RFFP - Right front facing power
RRFP - Right rear facing power
LFLR - Left front, left rear facing power
LFRF - Left front, right front facing power
LFRR - Left front, right rear facing power
LRRF - Left rear, right front facing power
LRRR - Left rear, right rear facing power
RRRF - Right rear, right front facing power
LFLRRR - Left front, left rear, right rear facing power

I Select power module color.
MPB - Black power module
MPS - Silver power module
MPW - White power module

J Select wood feet finish. Refer to the **Product Color Options** page in this price list.

K Select brushed aluminum feet finish. Refer to the **Product Color Options** page in this price list.

L Select moisture barrier.
MB - Moisture barrier
NMB - No moisture barrier
 See pricing column for moisture barrier upcharge.

INFORMATION

The removable seat design of MyPlace™ High-Back units allows for ease of installation and clean out, as well as inspection of electrical components. MyPlace™ High-Back offers power modules with a 3-prong plug (ETL Listed) or Byrne Interlink® IQ electrical system (an ETL Listed Furniture Power Distribution Unit, electrical system.) Because the system is ETL Listed, MyPlace™ Lounge has not been listed. All 48" high-back models can be used as free-standing units or can be ganged to other 48" high-back or 60" high-back models. Gangers are included for traditional lineal ganging with 48" high-back models, however, please note installing concealed gangers on 48" high-back models will permanently alter upholstery. Please see Installation Guide for further information related to ganging.

SPECIAL SERVICES

Special Carton Marking
 With specially marked information N/C

Shipping
 Ships **assembled, FOB High Point, NC 27263, freight prepaid.** Freight class 250.

Specifications and prices are subject to change without prior notice.



Features	MODEL NUMBER														Approx. Packaged Weight	Delivered Pricing	Moisture Barrier add to list price		
	Basic Model	Non-Cont or Fabric Cont 1	Fab Con 2	Fab Con 3	Pwr Opt	Pwr Type	MT Pwr Loc	IQ Pwr Type	IQ Mod Qty	IQ Pwr Loc	Power Color	Wood Feet Finish	Alum-inum Feet Finish	Moist Barr					
concealed glides shown 	Concealed Glide	MCOH44/CGL/FC	<input type="checkbox"/>	<input type="checkbox"/>	<input type="checkbox"/>	<input type="checkbox"/>	<input type="checkbox"/>	<input type="checkbox"/>	<input type="checkbox"/>	<input type="checkbox"/>	<input type="checkbox"/>	<input type="checkbox"/>	<input type="checkbox"/>	<input type="checkbox"/>	<input type="checkbox"/>	<input type="checkbox"/>	135.00#	\$ 2297	\$ 238
	Poly Feet	MCOH44/PFT/FC	<input type="checkbox"/>	<input type="checkbox"/>	<input type="checkbox"/>	<input type="checkbox"/>	<input type="checkbox"/>	<input type="checkbox"/>	<input type="checkbox"/>	<input type="checkbox"/>	<input type="checkbox"/>	<input type="checkbox"/>	<input type="checkbox"/>	<input type="checkbox"/>	<input type="checkbox"/>	<input type="checkbox"/>	135.00#	2297	238
	Wood Feet	MCOH44/WFT/FC	<input type="checkbox"/>	<input type="checkbox"/>	<input type="checkbox"/>	<input type="checkbox"/>	<input type="checkbox"/>	<input type="checkbox"/>	<input type="checkbox"/>	<input type="checkbox"/>	<input type="checkbox"/>	<input type="checkbox"/>	<input type="checkbox"/>	<input type="checkbox"/>	<input type="checkbox"/>	<input type="checkbox"/>	135.00#	2425	238
	Aluminum Feet	MCOH44/AFT/FC	<input type="checkbox"/>	<input type="checkbox"/>	<input type="checkbox"/>	<input type="checkbox"/>	<input type="checkbox"/>	<input type="checkbox"/>	<input type="checkbox"/>	<input type="checkbox"/>	<input type="checkbox"/>	<input type="checkbox"/>	<input type="checkbox"/>	<input type="checkbox"/>	<input type="checkbox"/>	<input type="checkbox"/>	135.00#	2425	238
MCO44																			
Outside Back, 45° Curve, 48" High-Back - Contrast																			
<ul style="list-style-type: none"> • 1 = Base (Contrast 1) C.O.M. = 2 yd • 2 = Seat (Contrast 2) C.O.M. = .75 yd • 3 = Back (Contrast 3) C.O.M. = 2.5 yd • Gangers included to gang to other High-Back models. • Ganging to backless units or High-Back back to side ganging (specify kit separately) • Does not gang with 32" Low-Back units • Cannot be retrofitted to 60" model • All base models have foot leveling capacity • Removable seat design, debris clean-out location, and painted wood base to protect against liquids. • Overall Dimensions: • W=41.5" D=26" H=48" • Seat Dimensions: • D=18.5" H=18" 																			
A B C D E F G H I J K L M N																			

HOW TO ORDER

- Indicate the following information on order form:
1. Quantity of each item.
 2. Model number, including options. See "How To Build a Model Number".
 3. Any special service required.

Note: • The indicates that a choice is required.
 • The absence of the indicates that no choice is required.
 • Alpha-numeric characters in place of indicate that no other alternatives are available.

HOW TO BUILD A MODEL NUMBER

- A** Select basic model.
- B** Select non-contrast or fabric contrast 1. Refer to ki.com/fabrics.
 • For yardage pricing, see Fabric Yardage Pricing page
- C** Select fabric contrast 2. Refer to ki.com/fabrics.
 • For yardage pricing, see Fabric Yardage Pricing page
- D** Select fabric contrast 3. Refer to ki.com/fabrics.
 • For yardage pricing, see Fabric Yardage Pricing page
- E** Select power option.
 NP - No power
 WP - With power
- F** Select power type.
 DCP - Byrne Interlink IQ System w/Mini-Tap module OR jumper (Interlink IQ Infeed to power Interlink IQ Systems ordered seperately)
 RPT - Mini-Tap power module w/3-prong plug; add \$314

- G** Select Mini-Tap® module w/3-prong plug location.
 LFFP - Left front facing power
 LRFP - Left rear facing power
 RFFP - Right front facing power
 RRFP - Right rear facing power
- H** Select Byrne Interlink®IQ System type.
 DCJ - Byrne Interlink IQ System jumper only; add \$124
 DSMOD - Byrne Interlink IQ System w/Mini-Tap modu
- I** Select Byrne Interlink®IQ System w/Mini-Tap® module quantity.
 MOD1 - One module; add \$404
 MOD2 - Two Modules; add \$807
 MOD3 - Three modules; add \$1211
 MOD4 - Four modules; add \$1614
- J** Select Byrne Interlink®IQ System w/Mini-Tap® module location(s).
 LFFP - Left front facing power
 LRFP - Left rear facing power
 RFFP - Right front facing power
 RRFP - Right rear facing power
 LFLR - Left front, left rear facing power

- K** Select power module color.
 MPB - Black power module
 MPS - Silver power module
 MPW - White power module
- L** Select wood feet finish. Refer to the **Product Color Options** page in this price list.
- M** Select brushed aluminum feet finish. Refer to the **Product Color Options** page in this price list.
- N** Select moisture barrier.
 MB - Moisture barrier
 NMB - No moisture barrier

See pricing column for moisture barrier upcharge.

INFORMATION

The removable seat design of MyPlace™ High-Back units allows for ease of installation and clean out, as well as inspection of electrical components. MyPlace™ High-Back offers power modules with a 3-prong plug (ETL Listed) or Byrne Interlink® IQ electrical system (an ETL Listed Furniture Power Distribution Unit, electrical system.) Because the system is ETL Listed, MyPlace™ Lounge has not been listed. All 48" high-back models can be used as free-standing units or can be ganged to other 48" high-back or 60" high-back models. Gangers are included for traditional lineal ganging with 48" high-back models, however, please note installing concealed gangers on 48" high-back models will permanently alter upholstery. Please see Installation Guide for further information related to ganging.

SPECIAL SERVICES

Special Carton Marking

With specially marked information N/C

Shipping
 Ships **assembled, FOB High Point, NC 27263, freight prepaid.** Freight class 250.

Specifications and prices are subject to change without prior notice.

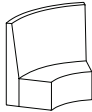

Features	MODEL NUMBER													Approx. Packaged Weight	Delivered Pricing	Moisture Barrier add to list price
	Basic Model	Non-Cont or Fabric Cont 1	Pwr Opt	Pwr Type	MT Pwr Loc	IQ Pwr Type	IQ Mod Qty	IQ Pwr Loc	Pwr Color	Wd Feet Fin	Alum Feet Fin	Moist Barr				
concealed glides shown 	Concealed Glide	MCIH64/CGL/NC	<input type="checkbox"/>	<input type="checkbox"/>	<input type="checkbox"/>	<input type="checkbox"/>	<input type="checkbox"/>	<input type="checkbox"/>	<input type="checkbox"/>	<input type="checkbox"/>	<input type="checkbox"/>	<input type="checkbox"/>	<input type="checkbox"/>	160.00#	\$ 2994	\$ 269
	Poly Feet	MCIH64/PFT/NC	<input type="checkbox"/>	<input type="checkbox"/>	<input type="checkbox"/>	<input type="checkbox"/>	<input type="checkbox"/>	<input type="checkbox"/>	<input type="checkbox"/>	<input type="checkbox"/>	<input type="checkbox"/>	<input type="checkbox"/>	<input type="checkbox"/>	160.00#	2994	269
	Wood Feet	MCIH64/WFT/NC	<input type="checkbox"/>	<input type="checkbox"/>	<input type="checkbox"/>	<input type="checkbox"/>	<input type="checkbox"/>	<input type="checkbox"/>	<input type="checkbox"/>	<input type="checkbox"/>	<input type="checkbox"/>	<input type="checkbox"/>	<input type="checkbox"/>	160.00#	3120	269
	Aluminum Feet	MCIH64/AFT/NC	<input type="checkbox"/>	<input type="checkbox"/>	<input type="checkbox"/>	<input type="checkbox"/>	<input type="checkbox"/>	<input type="checkbox"/>	<input type="checkbox"/>	<input type="checkbox"/>	<input type="checkbox"/>	<input type="checkbox"/>	<input type="checkbox"/>	160.00#	3120	269

MCI64
Inside Back, 60° Curve, 48" High-Back - Non-contrast
 • Non-contrast C.O.M = 6 yds
 • Gangers included to gang to other High-Back models.
 • Ganging to backless units or High-Back back to side ganging (specify kit separately)
 • Does not gang with 32" Low-Back units
 • Cannot be retrofitted to 60" model
 • All base models have foot leveling capacity
 • Removable seat design, debris clean-out location, and painted wood base to protect against liquids.
 • Overall Dimensions:
 • W=54" D=26" H=48"
 Seat Dimensions:
 • D=18.5" H=18"

A B C D E F G H I J K L

HOW TO ORDER

- Indicate the following information on order form:
 1. Quantity of each item.
 2. Model number, including options. See "How To Build a Model Number".
 3. Any special service required.

Note: • The indicates that a choice is required.
 • The absence of the indicates that no choice is required.
 • Alpha-numeric characters in place of indicate that no other alternatives are available.

HOW TO BUILD A MODEL NUMBER

- A** Select basic model.
B Select non-contrast or fabric contrast 1. Refer to ki.com/fabrics.
 • For yardage pricing, see Fabric Yardage Pricing page
C Select power option.
NP - No power
WP - With power
D Select power type.
DCP - Byrne Interlink IQ System w/Mini-Tap module OR jumper (Interlink IQ Infeed to power Interlink IQ Systems ordered separately)
RPT - Mini-Tap power module w/3-prong plug; add \$314
E Select Mini-Tap® module w/3-prong plug location.
LFFP - Left front facing power
LRFP - Left rear facing power
RFFP - Right front facing power
RRFP - Right rear facing power

- F** Select Byrne Interlink®IQ System type.
DCJ - Byrne Interlink IQ System jumper only; add \$183
DSMOD - Byrne Interlink IQ System w/Mini-Tap module
G Select Byrne Interlink®IQ System w/Mini-Tap® module quantity.
MOD4 - Four modules; add \$1705
MOD1 - One module; add \$495
MOD3 - Three modules; add \$1301
MOD2 - Two Modules; add \$899
H Select Byrne Interlink®IQ System w/Mini-Tap® module location(s).
LFLR - Left front, left rear facing power
LFRF - Left front, right front facing power
LFRR - Left front, right rear facing power
LRRF - Left rear, right front facing power
LRRR - Left rear, right rear facing power
RRRF - Right rear, right front facing power
LRFLLRR - Left front, right front, left rear, right rear facing power
LFLRRR - Left front, left rear, right rear facing power
LRFRLR - Left front, right front, left rear facing power

- LFRFRR** - Left front, right front, right rear facing power
RFLRRR - Right front, left rear, right rear facing power
LFFP - Left front facing power
LRFP - Left rear facing power
RFFP - Right front facing power
RRFP - Right rear facing power
I Select power module color.
MPB - Black power module
MPS - Silver power module
MPW - White power module
J Select wood feet finish. Refer to the **Product Color Options** page in this price list.
K Select brushed aluminum feet finish. Refer to the **Product Color Options** page in this price list.
L Select moisture barrier.
MB - Moisture barrier
NMB - No moisture barrier

See pricing column for moisture barrier upcharge.

INFORMATION

The removable seat design of MyPlace™ High-Back units allows for ease of installation and clean out, as well as inspection of electrical components. MyPlace™ High-Back offers power modules with a 3-prong plug (ETL Listed) or Byrne Interlink® IQ electrical system (an ETL Listed Furniture Power Distribution Unit, electrical system.) Because the system is ETL Listed, MyPlace™ Lounge has not been listed. All 48" high-back models can be used as free-standing units or can be ganged to other 48" high-back or 60" high-back models. Gangers are included for traditional lineal ganging with 48" high-back models, however, please note installing concealed gangers on 48" high-back models will permanently alter upholstery. Please see Installation Guide for further information related to ganging.

SPECIAL SERVICES

Special Carton Marking

With specially marked information N/C

Shipping
 Ships **assembled, FOB High Point, NC 27263, freight prepaid.** Freight class 250.

Specifications and prices are subject to change without prior notice.



Features	MODEL NUMBER														Approx. Packaged Weight	Delivered Pricing	Moisture Barrier add to list price		
	Basic Model	Non-Cont or Fabric Cont 1	Fab Con 2	Fab Con 3	Pwr Opt	Pwr Type	MT Pwr Loc	IQ Pwr Type	IQ Mod Qty	IQ Pwr Loc	Pwr Color	Wd Feet Fin	Alum Feet Fin	Moist Barr					
concealed glides shown 	Concealed Glide	MCIH64/CGL/FC	<input type="checkbox"/>	<input type="checkbox"/>	<input type="checkbox"/>	<input type="checkbox"/>	<input type="checkbox"/>	<input type="checkbox"/>	<input type="checkbox"/>	<input type="checkbox"/>	<input type="checkbox"/>	<input type="checkbox"/>	<input type="checkbox"/>	<input type="checkbox"/>	<input type="checkbox"/>	<input type="checkbox"/>	160.00#	\$ 3048	\$ 269
	Poly Feet	MCIH64/PFT/FC	<input type="checkbox"/>	<input type="checkbox"/>	<input type="checkbox"/>	<input type="checkbox"/>	<input type="checkbox"/>	<input type="checkbox"/>	<input type="checkbox"/>	<input type="checkbox"/>	<input type="checkbox"/>	<input type="checkbox"/>	<input type="checkbox"/>	<input type="checkbox"/>	<input type="checkbox"/>	<input type="checkbox"/>	160.00#	3048	269
	Wood Feet	MCIH64/WFT/FC	<input type="checkbox"/>	<input type="checkbox"/>	<input type="checkbox"/>	<input type="checkbox"/>	<input type="checkbox"/>	<input type="checkbox"/>	<input type="checkbox"/>	<input type="checkbox"/>	<input type="checkbox"/>	<input type="checkbox"/>	<input type="checkbox"/>	<input type="checkbox"/>	<input type="checkbox"/>	<input type="checkbox"/>	160.00#	3177	269
	Aluminum Feet	MCIH64/AFT/FC	<input type="checkbox"/>	<input type="checkbox"/>	<input type="checkbox"/>	<input type="checkbox"/>	<input type="checkbox"/>	<input type="checkbox"/>	<input type="checkbox"/>	<input type="checkbox"/>	<input type="checkbox"/>	<input type="checkbox"/>	<input type="checkbox"/>	<input type="checkbox"/>	<input type="checkbox"/>	<input type="checkbox"/>	160.00#	3177	269

MCI64
Inside Back, 60° Curve, 48" High-Back - Contrast

- 1 = Base (Contrast 1) C.O.M. = 2 yd
- 2 = Seat (Contrast 2) C.O.M. = 1 yd
- 3 = Back (Contrast 3) C.O.M. = 5.25 yd
- Gangers included to gang to other High-Back models.
- Ganging to backless units or High-Back back to side ganging (specify kit separately)
- Does not gang with 32" Low-Back units
- Cannot be retrofitted to 60" model
- All base models have foot leveling capacity
- Removable seat design, debris clean-out location, and painted wood base to protect against liquids.
- Overall Dimensions:
• W=54" D=26" H=48"
- Seat Dimensions:
• D=18.5" H=18"

HOW TO ORDER

Indicate the following information on order form:
 1. Quantity of each item.
 2. Model number, including options. See "How To Build a Model Number".
 3. Any special service required.

Note: • The indicates that a choice is required.
 • The absence of the indicates that no choice is required.
 • Alpha-numeric characters in place of indicate that no other alternatives are available.

HOW TO BUILD A MODEL NUMBER

- A** Select basic model.
- B** Select non-contrast or fabric contrast 1. Refer to ki.com/fabrics.
• For yardage pricing, see Fabric Yardage Pricing page
- C** Select fabric contrast 2. Refer to ki.com/fabrics.
• For yardage pricing, see Fabric Yardage Pricing page
- D** Select fabric contrast 3. Refer to ki.com/fabrics.
• For yardage pricing, see Fabric Yardage Pricing page
- E** Select power option.

NP	- No power
WP	- With power
- F** Select power type.

DCP	- Byrne Interlink IQ System w/Mini-Tap module OR jumper (Interlink IQ infeed to power Interlink IQ Systems ordered seperately)
RPT	- Mini-Tap power module w/3-prong plug; add \$314
- G** Select Mini-Tap® module w/3-prong plug location.

LFFP	- Left front facing power
LRFP	- Left rear facing power
RFFP	- Right front facing power
RRFP	- Right rear facing power
- H** Select Byrne Interlink®IQ System type.

DCJ	- Byrne Interlink IQ System jumper only; add \$124
DSMOD	- Byrne Interlink IQ System w/Mini-Tap module
- I** Select Byrne Interlink®IQ System w/Mini-Tap® module quantity.

MOD1	- One module; add \$404
MOD2	- Two Modules; add \$807
MOD3	- Three modules; add \$1211
MOD4	- Four modules; add \$1614
- J** Select Byrne Interlink®IQ System w/Mini-Tap® module location(s).

LFFP	- Left front facing power
LRFP	- Left rear facing power
RFFP	- Right front facing power
RRFP	- Right rear facing power

- LFLR** - Left front, left rear facing power
- LFRF** - Left front, right front facing power
- LRFR** - Left front, right rear facing power
- LRRF** - Left rear, right front facing power
- LRRR** - Left rear, right rear facing power
- RRRF** - Right rear, right front facing power
- LFLRRR** - Left front, left rear, right rear facing power
- LFRFLR** - Left front, right front, left rear facing power
- LFRFRR** - Left front, right front, right rear facing power
- RFLRRR** - Right front, left rear, right rear facing power
- LFRFLRRR** - Left front, right front, left rear, right rear facing power

- K** Select power module color.

MPB	- Black power module
MPS	- Silver power module
MPW	- White power module

- L** Select wood feet finish.
Refer to the **Product Color Options** page in this price list.

- M** Select brushed aluminum feet finish.
Refer to the **Product Color Options** page in this price list.

- N** Select moisture barrier.

MB	- Moisture barrier
NMB	- No moisture barrier

See pricing column for moisture barrier upcharge.

INFORMATION

The removable seat design of MyPlace™ High-Back units allows for ease of installation and clean out, as well as inspection of electrical components. MyPlace™ High-Back offers power modules with a 3-prong plug (ETL Listed) or Byrne Interlink® IQ electrical system (an ETL Listed Furniture Power Distribution Unit, electrical system.) Because the system is ETL Listed, MyPlace™ Lounge has not been listed. All 48" high-back models can be used as free-standing units or can be ganged to other 48" high-back or 60" high-back models. Gangers are included for traditional lineal ganging with 48" high-back models, however, please note installing concealed gangers on 48" high-back models will permanently alter upholstery. Please see Installation Guide for further information related to ganging.

SPECIAL SERVICES

Special Carton Marking

With specially marked information N/C

Shipping
Ships **assembled, FOB High Point, NC 27263, freight prepaid.** Freight class 250.

Specifications and prices are subject to change without prior notice.



Features	MODEL NUMBER													Approx. Packaged Weight	Delivered Pricing	Moisture Barrier add to list price	
	Basic Model	Non-Cont or Fabric Cont 1	Pwr Opt	Pwr Type	MT Pwr Loc	IQ Pwr Type	IQ Mod Qty	IQ Pwr Loc	Pwr Color	Wd Feet Fin	Alum Feet Fin	Moist Barr					
concealed glides shown 	Concealed Glide	MCOH64/CGL/NC	<input type="checkbox"/>	<input type="checkbox"/>	<input type="checkbox"/>	<input type="checkbox"/>	<input type="checkbox"/>	<input type="checkbox"/>	<input type="checkbox"/>	<input type="checkbox"/>	<input type="checkbox"/>	<input type="checkbox"/>	<input type="checkbox"/>	<input type="checkbox"/>	165.00#	\$ 2888	\$ 252
	Poly Feet	MCOH64/PFT/NC	<input type="checkbox"/>	<input type="checkbox"/>	<input type="checkbox"/>	<input type="checkbox"/>	<input type="checkbox"/>	<input type="checkbox"/>	<input type="checkbox"/>	<input type="checkbox"/>	<input type="checkbox"/>	<input type="checkbox"/>	<input type="checkbox"/>	<input type="checkbox"/>	165.00#	2888	252
	Wood Feet	MCOH64/WFT/NC	<input type="checkbox"/>	<input type="checkbox"/>	<input type="checkbox"/>	<input type="checkbox"/>	<input type="checkbox"/>	<input type="checkbox"/>	<input type="checkbox"/>	<input type="checkbox"/>	<input type="checkbox"/>	<input type="checkbox"/>	<input type="checkbox"/>	<input type="checkbox"/>	165.00#	2984	252
	Aluminum Feet	MCOH64/AFT/NC	<input type="checkbox"/>	<input type="checkbox"/>	<input type="checkbox"/>	<input type="checkbox"/>	<input type="checkbox"/>	<input type="checkbox"/>	<input type="checkbox"/>	<input type="checkbox"/>	<input type="checkbox"/>	<input type="checkbox"/>	<input type="checkbox"/>	<input type="checkbox"/>	165.00#	2984	252
MCO64																	
Outside Back, 60° Curve, 48" High-Back - Non-contrast																	
<ul style="list-style-type: none"> • Non-contrast C.O.M = 5 yds • Gangers included to gang to other High-Back models. • Ganging to backless units or High-Back back to side ganging (specify kit separately) • Does not gang with 32" Low-Back units • Cannot be retrofitted to 60" model • All base models have foot leveling capacity • Removable seat design, debris clean-out location, and painted wood base to protect against liquids. • Overall Dimensions: • W=54" D=26" H=48" • Seat Dimensions: • D=18.5" H=18" 																	
A B C D E F G H I J K L																	

HOW TO ORDER

- Indicate the following information on order form:
1. Quantity of each item.
 2. Model number, including options. See "How To Build a Model Number".
 3. Any special service required.

Note: • The indicates that a choice is required.
• The absence of the indicates that no choice is required.
• Alpha-numeric characters in place of indicate that no other alternatives are available.

HOW TO BUILD A MODEL NUMBER

- A** Select basic model.
- B** Select non-contrast or fabric contrast 1.
Refer to ki.com/fabrics.
• For yardage pricing, see Fabric Yardage Pricing page
- C** Select power option.
NP - No power
WP - With power
- D** Select power type.
DCP - Byrne Interlink IQ System w/Mini-Tap module OR jumper (Interlink IQ Infeed to power Interlink IQ Systems ordered separately)
RPT - Mini-Tap power module w/3-prong plug; add \$314
- E** Select Mini-Tap® module w/3-prong plug location.
LFFP - Left front facing power
LRFP - Left rear facing power
RFFP - Right front facing power
RRFP - Right rear facing power

- F** Select Byrne Interlink®IQ System type.
DCJ - Byrne Interlink IQ System jumper only; add \$124
DSMOD - Byrne Interlink IQ System w/Mini-Tap module
- G** Select Byrne Interlink®IQ System w/Mini-Tap® module quantity.
MOD1 - One module; add \$404
MOD2 - Two Modules; add \$807
MOD3 - Three modules; add \$1211
MOD4 - Four modules; add \$1614
- H** Select Byrne Interlink®IQ System w/Mini-Tap® module location(s).
LFFP - Left front facing power
LRFP - Left rear facing power
RFFP - Right front facing power
RRFP - Right rear facing power
LFLR - Left front, left rear facing power
LFRF - Left front, right front facing power
LFRR - Left front, right rear facing power
LRRF - Left rear, right front facing power
LRRR - Left rear, right rear facing power
RRRF - Right rear, right front facing power
RRLRRR - Left front, left rear, right rear facing power

- I** Select power module color.
MPB - Black power module
MPS - Silver power module
MPW - White power module
- J** Select wood feet finish.
Refer to the **Product Color Options** page in this price list.
- K** Select brushed aluminum feet finish.
Refer to the **Product Color Options** page in this price list.
- L** Select moisture barrier.
MB - Moisture barrier
NMB - No moisture barrier
See pricing column for moisture barrier upcharge.

INFORMATION

The removable seat design of MyPlace™ High-Back units allows for ease of installation and clean out, as well as inspection of electrical components. MyPlace™ High-Back offers power modules with a 3-prong plug (ETL Listed) or Byrne Interlink® IQ electrical system (an ETL Listed Furniture Power Distribution Unit, electrical system.) Because the system is ETL Listed, MyPlace™ Lounge has not been listed. All 48" high-back models can be used as free-standing units or can be ganged to other 48" high-back or 60" high-back models. Gangers are included for traditional lineal ganging with 48" high-back models, however, please note installing concealed gangers on 48" high-back models will permanently alter upholstery. Please see Installation Guide for further information related to ganging.

SPECIAL SERVICES

Special Carton Marking

With specially marked information N/C

Shipping
Ships **assembled, FOB High Point, NC 27263, freight prepaid.** Freight class 250.

Specifications and prices are subject to change without prior notice.



Features	MODEL NUMBER														Approx. Packaged Weight	Delivered Pricing	Moisture Barrier add to list price		
	Basic Model	Non-Cont or Fabric Cont 1	Fab Con 2	Fab Con 3	Pwr Opt	Pwr Type	MT Pwr Loc	IQ Pwr Type	IQ Mod Qty	IQ Pwr Loc	Pwr Color	Wd Feet Fin	Alum Feet Fin	Moist Barr					
concealed glides shown 	Concealed Glide	MCOH64/CGL/FC	<input type="checkbox"/>	<input type="checkbox"/>	<input type="checkbox"/>	<input type="checkbox"/>	<input type="checkbox"/>	<input type="checkbox"/>	<input type="checkbox"/>	<input type="checkbox"/>	<input type="checkbox"/>	<input type="checkbox"/>	<input type="checkbox"/>	<input type="checkbox"/>	<input type="checkbox"/>	<input type="checkbox"/>	165.00#	\$ 2940	\$ 252
	Poly Feet	MCOH64/PFT/FC	<input type="checkbox"/>	<input type="checkbox"/>	<input type="checkbox"/>	<input type="checkbox"/>	<input type="checkbox"/>	<input type="checkbox"/>	<input type="checkbox"/>	<input type="checkbox"/>	<input type="checkbox"/>	<input type="checkbox"/>	<input type="checkbox"/>	<input type="checkbox"/>	<input type="checkbox"/>	<input type="checkbox"/>	165.00#	2940	252
	Wood Feet	MCOH64/WFT/FC	<input type="checkbox"/>	<input type="checkbox"/>	<input type="checkbox"/>	<input type="checkbox"/>	<input type="checkbox"/>	<input type="checkbox"/>	<input type="checkbox"/>	<input type="checkbox"/>	<input type="checkbox"/>	<input type="checkbox"/>	<input type="checkbox"/>	<input type="checkbox"/>	<input type="checkbox"/>	<input type="checkbox"/>	165.00#	3069	252
	Aluminum Feet	MCOH64/AFT/FC	<input type="checkbox"/>	<input type="checkbox"/>	<input type="checkbox"/>	<input type="checkbox"/>	<input type="checkbox"/>	<input type="checkbox"/>	<input type="checkbox"/>	<input type="checkbox"/>	<input type="checkbox"/>	<input type="checkbox"/>	<input type="checkbox"/>	<input type="checkbox"/>	<input type="checkbox"/>	<input type="checkbox"/>	165.00#	3069	252
MCO64																			
Outside Back, 60° Curve, 48" High-Back - Contrast																			
<ul style="list-style-type: none"> • 1 = Base (Contrast 1) C.O.M. = 2 yd • 2 = Seat (Contrast 2) C.O.M. = 1 yd • 3 = Back (Contrast 3) C.O.M. = 2.5 yd • Gangers included to gang to other High-Back models. • Ganging to backless units or High-Back back to side ganging (specify kit separately) • Does not gang with 32" Low-Back units • Cannot be retrofitted to 60" model • All base models have foot leveling capacity • Removable seat design, debris clean-out location, and painted wood base to protect against liquids. • Overall Dimensions: • W=54" D=26" H=48" • Seat Dimensions: • D=18.5" H=18" 																			
A B C D E F G H I J K L M N																			

HOW TO ORDER

- Indicate the following information on order form:
1. Quantity of each item.
 2. Model number, including options. See "How To Build a Model Number".
 3. Any special service required.

Note: • The indicates that a choice is required.
• The absence of the indicates that no choice is required.
• Alpha-numeric characters in place of indicate that no other alternatives are available.

HOW TO BUILD A MODEL NUMBER

- A** Select basic model.
- B** Select non-contrast or fabric contrast 1. Refer to ki.com/fabrics.
• For yardage pricing, see Fabric Yardage Pricing page
- C** Select fabric contrast 2. Refer to ki.com/fabrics.
• For yardage pricing, see Fabric Yardage Pricing page
- D** Select fabric contrast 3. Refer to ki.com/fabrics.
• For yardage pricing, see Fabric Yardage Pricing page
- E** Select power option.
NP - No power
WP - With power
- F** Select power type.
DCP - Byrne Interlink IQ System w/Mini-Tap module OR jumper (Interlink IQ Infeed to power Interlink IQ Systems ordered seperately)
RPT - Mini-Tap power module w/3-prong plug; add \$314

- G** Select Mini-Tap® module w/3-prong plug location.
LFPP - Left front facing power
LRFP - Left rear facing power
RFFP - Right front facing power
RRFP - Right rear facing power
- H** Select Byrne Interlink®IQ System type.
DCJ - Byrne Interlink IQ System jumper only; add \$124
DSMOD - Byrne Interlink IQ System w/Mini-Tap module
- I** Select Byrne Interlink®IQ System w/Mini-Tap® module quantity.
MOD1 - One module; add \$404
MOD2 - Two Modules; add \$807
MOD3 - Three modules; add \$1211
MOD4 - Four modules; add \$1614
- J** Select Byrne Interlink®IQ System w/Mini-Tap® module location(s).
LFPP - Left front facing power
LRFP - Left rear facing power
RFFP - Right front facing power
RRFP - Right rear facing power
LFLR - Left front, left rear facing power
LFRR - Left front, right front facing power

- K** Select power module color.
MPB - Black power module
MPS - Silver power module
MPW - White power module
- L** Select wood feet finish. Refer to the **Product Color Options** page in this price list.
- M** Select brushed aluminum feet finish. Refer to the **Product Color Options** page in this price list.
- N** Select moisture barrier.
MB - Moisture barrier
NMB - No moisture barrier
See pricing column for moisture barrier upcharge.

INFORMATION

The removable seat design of MyPlace™ High-Back units allows for ease of installation and clean out, as well as inspection of electrical components. MyPlace™ High-Back offers power modules with a 3-prong plug (ETL Listed) or Byrne Interlink® IQ electrical system (an ETL Listed Furniture Power Distribution Unit, electrical system.) Because the system is ETL Listed, MyPlace™ Lounge has not been listed. All 48" high-back models can be used as free-standing units or can be ganged to other 48" high-back or 60" high-back models. Gangers are included for traditional lineal ganging with 48" high-back models, however, please note installing concealed gangers on 48" high-back models will permanently alter upholstery. Please see Installation Guide for further information related to ganging.

SPECIAL SERVICES

Special Carton Marking

With specially marked information N/C

Shipping

Ships **assembled, FOB High Point, NC 27263, freight prepaid.** Freight class 250.

Specifications and prices are subject to change without prior notice.

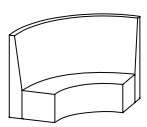

Features	MODEL NUMBER													Approx. Packaged Weight	Delivered Pricing	Moisture Barrier add to list price
	Basic Model	Non-Cont or Fabric Cont 1	Pwr Opt	Pwr Type	MT Pwr Loc	IQ Pwr Type	IQ Mod Qty	IQ Pwr Loc	Pwr Color	Wd Feet Fin	Alum Feet Fin	Moist Barr				
concealed glides shown 	Concealed Glide	MCIH94/CGL/NC	<input type="checkbox"/>	<input type="checkbox"/>	<input type="checkbox"/>	<input type="checkbox"/>	<input type="checkbox"/>	<input type="checkbox"/>	<input type="checkbox"/>	<input type="checkbox"/>	<input type="checkbox"/>	<input type="checkbox"/>	<input type="checkbox"/>	223.00#	\$ 3322	\$ 309
	Poly Feet	MCIH94/PFT/NC	<input type="checkbox"/>	<input type="checkbox"/>	<input type="checkbox"/>	<input type="checkbox"/>	<input type="checkbox"/>	<input type="checkbox"/>	<input type="checkbox"/>	<input type="checkbox"/>	<input type="checkbox"/>	<input type="checkbox"/>	<input type="checkbox"/>	223.00#	3322	309
	Wood Feet	MCIH94/WFT/NC	<input type="checkbox"/>	<input type="checkbox"/>	<input type="checkbox"/>	<input type="checkbox"/>	<input type="checkbox"/>	<input type="checkbox"/>	<input type="checkbox"/>	<input type="checkbox"/>	<input type="checkbox"/>	<input type="checkbox"/>	<input type="checkbox"/>	223.00#	3448	309
	Aluminum Feet	MCIH94/AFT/NC	<input type="checkbox"/>	<input type="checkbox"/>	<input type="checkbox"/>	<input type="checkbox"/>	<input type="checkbox"/>	<input type="checkbox"/>	<input type="checkbox"/>	<input type="checkbox"/>	<input type="checkbox"/>	<input type="checkbox"/>	<input type="checkbox"/>	223.00#	3448	309

MCI94
Inside Back, 90° Curve, 48" High-Back - Non-contrast

- Non-contrast C.O.M = 8.75 yds
- Gangers included to gang to other High-Back models.
- Ganging to backless units or High-Back back to side ganging (specify kit separately)
- Does not gang with 32" Low-Back units
- Cannot be retrofitted to 60" model
- If Byrne Interlink®IQ Power is specified, an additional jumper is always included due to product size, impacting total count for one infeed. See Planning Guide for more information.
- All base models have foot leveling capacity
- Removable seat design, debris clean-out location, and painted wood base to protect against liquids.
- Overall Dimensions:
 • W=76.5" D=26" H=48"
 Seat Dimensions:
 • D=18.5" H=18"

A B C D E F G H I J K L

HOW TO ORDER

Indicate the following information on order form:

1. Quantity of each item.
2. Model number, including options. See "How To Build a Model Number".
3. Any special service required.

Note:

- The indicates that a choice is required.
- The absence of the indicates that no choice is required.
- Alpha-numeric characters in place of indicate that no other alternatives are available.

HOW TO BUILD A MODEL NUMBER

A Select basic model.

B Select non-contrast or fabric contrast 1. Refer to ki.com/fabrics.
 • For yardage pricing, see Fabric Yardage Pricing page

C Select power option.
NP - No power
WP - With power

D Select power type.
DCP - Byrne Interlink IQ System w/Mini-Tap module OR jumper (Interlink IQ Infeed to power Interlink IQ Systems ordered separately)
RPT - Mini-Tap power module w/3-prong plug; add \$314

E Select Mini-Tap® module w/3-prong plug location.
LFFP - Left front facing power
LRFP - Left rear facing power
RFFP - Right front facing power
RRFP - Right rear facing power

F Select Byrne Interlink®IQ System type.
DCJ - Byrne Interlink IQ System jumper only; add \$183
DSMOD - Byrne Interlink IQ System w/Mini-Tap module

G Select Byrne Interlink®IQ System w/Mini-Tap® module quantity.
MOD1 - One module; add \$495
MOD2 - Two Modules; add \$899
MOD3 - Three modules; add \$1301
MOD4 - Four modules; add \$1705

H Select Byrne Interlink®IQ System w/Mini-Tap® module location(s).
LFFP - Left front facing power
LRFP - Left rear facing power
RFFP - Right front facing power
RRFP - Right rear facing power
LFLR - Left front, left rear facing power
LFRR - Left front, right rear facing power
LRFR - Left front, right front facing power
LRRR - Left rear, right rear facing power
LRRF - Left rear, right front facing power
RRRR - Right rear, right front facing power
LFLRRR - Left front, left rear, right rear facing power

I Select power module color.
MPB - Black power module
MPS - Silver power module
MPW - White power module

J Select wood feet finish. Refer to the **Product Color Options** page in this price list.

K Select brushed aluminum feet finish. Refer to the **Product Color Options** page in this price list.

L Select moisture barrier.
MB - Moisture barrier
NMB - No moisture barrier
 See pricing column for moisture barrier upcharge.

LFRFLR - Left front, right front, left rear facing power
LFRFRR - Left front, right front, right rear facing power
RFLRRR - Right front, left rear, right rear facing power
LFRFLRRR - Left front, right front, left rear, right rear facing power

INFORMATION

The removable seat design of MyPlace™ High-Back units allows for ease of installation and clean out, as well as inspection of electrical components. MyPlace™ High-Back offers power modules with a 3-prong plug (ETL Listed) or Byrne Interlink® IQ electrical system (an ETL Listed Furniture Power Distribution Unit, electrical system.) Because the system is ETL Listed, MyPlace™ Lounge has not been listed. All 48" high-back models can be used as free-standing units or can be ganged to other 48" high-back or 60" high-back models. Gangers are included for traditional lineal ganging with 48" high-back models, however, please note installing concealed gangers on 48" high-back models will permanently alter upholstery. Please see Installation Guide for further information related to ganging.

SPECIAL SERVICES

Special Carton Marking
 With specially marked information N/C

Shipping
 Ships **assembled, FOB High Point, NC 27263, freight prepaid.** Freight class 250.

Specifications and prices are subject to change without prior notice.

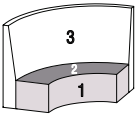

Features	MODEL NUMBER														Approx. Packaged Weight	Delivered Pricing	Moisture Barrier add to list price		
	Basic Model	Non-Cont or Fabric Cont 1	Fab Con 2	Fab Con 3	Pwr Opt	Pwr Type	MT Pwr Loc	IQ Pwr Type	IQ Mod Qty	IQ Pwr Loc	Pwr Color	Wd Feet Fin	Alum Feet Fin	Moist Barr					
concealed glides shown 	Concealed Glide	MCIH94/CGL/FC	<input type="checkbox"/>	<input type="checkbox"/>	<input type="checkbox"/>	<input type="checkbox"/>	<input type="checkbox"/>	<input type="checkbox"/>	<input type="checkbox"/>	<input type="checkbox"/>	<input type="checkbox"/>	<input type="checkbox"/>	<input type="checkbox"/>	<input type="checkbox"/>	<input type="checkbox"/>	<input type="checkbox"/>	223.00#	\$ 3382	\$ 309
	Poly Feet	MCIH94/PFT/FC	<input type="checkbox"/>	<input type="checkbox"/>	<input type="checkbox"/>	<input type="checkbox"/>	<input type="checkbox"/>	<input type="checkbox"/>	<input type="checkbox"/>	<input type="checkbox"/>	<input type="checkbox"/>	<input type="checkbox"/>	<input type="checkbox"/>	<input type="checkbox"/>	<input type="checkbox"/>	<input type="checkbox"/>	223.00#	3382	309
	Wood Feet	MCIH94/WFT/FC	<input type="checkbox"/>	<input type="checkbox"/>	<input type="checkbox"/>	<input type="checkbox"/>	<input type="checkbox"/>	<input type="checkbox"/>	<input type="checkbox"/>	<input type="checkbox"/>	<input type="checkbox"/>	<input type="checkbox"/>	<input type="checkbox"/>	<input type="checkbox"/>	<input type="checkbox"/>	<input type="checkbox"/>	223.00#	3509	309
	Aluminum Feet	MCIH94/AFT/FC	<input type="checkbox"/>	<input type="checkbox"/>	<input type="checkbox"/>	<input type="checkbox"/>	<input type="checkbox"/>	<input type="checkbox"/>	<input type="checkbox"/>	<input type="checkbox"/>	<input type="checkbox"/>	<input type="checkbox"/>	<input type="checkbox"/>	<input type="checkbox"/>	<input type="checkbox"/>	<input type="checkbox"/>	223.00#	3509	309

MCI94
Inside Back, 90° Curve, 48" High-Back - Contrast

- 1 = Base (Contrast 1) C.O.M. = 2.5 yd
- 2 = Seat (Contrast 2) C.O.M. = 1.5 yd
- 3 = Back (Contrast 3) C.O.M. = 5.75 yd
- Gangers included to gang to other High-Back models.
- Ganging to backless units or High-Back back to side ganging (specify kit separately)
- Does not gang with 32" Low-Back units
- Cannot be retrofitted to 60" model
- If Byrne Interlink®IQ Power is specified, an additional jumper is always included due to product size, impacting total count for one infeed. See Planning Guide for more information.
- All base models have foot leveling capacity
- Removable seat design, debris clean-out location, and painted wood base to protect against liquids.
- Overall Dimensions:
 - W=76.5" D=26" H=48"
 - Seat Dimensions:
 - D=18.5" H=18"

HOW TO ORDER

Indicate the following information on order form:

- Quantity of each item.
- Model number, including options. See "How To Build a Model Number".
- Any special service required.

Note:

- The indicates that a choice is required.
- The absence of the indicates that no choice is required.
- Alpha-numeric characters in place of indicate that no other alternatives are available.

HOW TO BUILD A MODEL NUMBER

A Select basic model.

B Select non-contrast or fabric contrast 1.
Refer to ki.com/fabrics.
• For yardage pricing, see Fabric Yardage Pricing page

C Select fabric contrast 2.
Refer to ki.com/fabrics.
• For yardage pricing, see Fabric Yardage Pricing page

D Select fabric contrast 3.
Refer to ki.com/fabrics.
• For yardage pricing, see Fabric Yardage Pricing page

E Select power option.
NP - No power
WP - With power

F Select power type.
DCP - Byrne Interlink IQ System w/Mini-Tap module OR jumper (Interlink IQ Infeed to power Interlink IQ Systems ordered seperately)
RPT - Mini-Tap power module w/3-prong plug; add \$314

G Select Mini-Tap® module w/3-prong plug location.
LFFP - Left front facing power
LRFP - Left rear facing power
RFFP - Right front facing power
RRFP - Right rear facing power

H Select Byrne Interlink®IQ System type.
DCJ - Byrne Interlink IQ System jumper only; add \$183
DSMOD - Byrne Interlink IQ System w/Mini-Tap module

I Select Byrne Interlink®IQ System w/Mini-Tap® module quantity.
MOD1 - One module; add \$495
MOD2 - Two Modules; add \$899
MOD3 - Three modules; add \$1301
MOD4 - Four modules; add \$1705

J Select Byrne Interlink®IQ System w/Mini-Tap® module location(s).
LFFP - Left front facing power
LRFP - Left rear facing power
RFFP - Right front facing power
RRFP - Right rear facing power
LFLR - Left front, left rear facing power
LFRF - Left front, right front facing power
LFRR - Left front, right rear facing power
LRRF - Left rear, right front facing power

K Select power module color.
MPB - Black power module
MPS - Silver power module
MPW - White power module

L Select wood feet finish.
Refer to the **Product Color Options** page in this price list.

M Select brushed aluminum feet finish.
Refer to the **Product Color Options** page in this price list.

N Select moisture barrier.
MB - Moisture barrier
NMB - No moisture barrier
See pricing column for moisture barrier upcharge.

LRRR - Left rear, right rear facing power
RRRF - Right rear, right front facing power
LFLRRR - Left front, left rear, right rear facing power
LFRFLR - Left front, right front, left rear facing power
LFRFRR - Left front, right front, right rear facing power
RFLRRR - Right front, left rear, right rear facing power
LFRFLRRR - Left front, right front, left rear, right rear facing power

INFORMATION

The removable seat design of MyPlace™ High-Back units allows for ease of installation and clean out, as well as inspection of electrical components. MyPlace™ High-Back offers power modules with a 3-prong plug (ETL Listed) or Byrne Interlink® IQ electrical system (an ETL Listed Furniture Power Distribution Unit, electrical system.) Because the system is ETL Listed, MyPlace™ Lounge has not been listed. All 48" high-back models can be used as free-standing units or can be ganged to other 48" high-back or 60" high-back models. Gangers are included for traditional lineal ganging with 48" high-back models, however, please note installing concealed gangers on 48" high-back models will permanently alter upholstery. Please see Installation Guide for further information related to ganging.

SPECIAL SERVICES

Special Carton Marking
With specially marked information N/C

Shipping
Ships **assembled, FOB High Point, NC 27263, freight prepaid.** Freight class 250.

Specifications and prices are subject to change without prior notice.

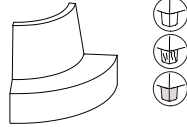

Features	MODEL NUMBER													Approx. Packaged Weight	Delivered Pricing	Moisture Barrier add to list price	
	Basic Model	Non-Cont or Fabric Cont 1	Pwr Opt	Pwr Type	MT Pwr Loc	IQ Pwr Type	IQ Mod Qty	IQ Pwr Loc	Pwr Color	Wd Feet Fin	Alum Feet Fin	Moist Barr					
concealed glides shown 	Concealed Glide	MCOH94/CGL/NC	<input type="checkbox"/>	<input type="checkbox"/>	<input type="checkbox"/>	<input type="checkbox"/>	<input type="checkbox"/>	<input type="checkbox"/>	<input type="checkbox"/>	<input type="checkbox"/>	<input type="checkbox"/>	<input type="checkbox"/>	<input type="checkbox"/>	<input type="checkbox"/>	190.00#	\$ 3242	\$ 279
	Poly Feet	MCOH94/PFT/NC	<input type="checkbox"/>	<input type="checkbox"/>	<input type="checkbox"/>	<input type="checkbox"/>	<input type="checkbox"/>	<input type="checkbox"/>	<input type="checkbox"/>	<input type="checkbox"/>	<input type="checkbox"/>	<input type="checkbox"/>	<input type="checkbox"/>	<input type="checkbox"/>	190.00#	3242	279
	Wood Feet	MCOH94/WFT/NC	<input type="checkbox"/>	<input type="checkbox"/>	<input type="checkbox"/>	<input type="checkbox"/>	<input type="checkbox"/>	<input type="checkbox"/>	<input type="checkbox"/>	<input type="checkbox"/>	<input type="checkbox"/>	<input type="checkbox"/>	<input type="checkbox"/>	<input type="checkbox"/>	190.00#	3369	279
	Aluminum Feet	MCOH94/AFT/NC	<input type="checkbox"/>	<input type="checkbox"/>	<input type="checkbox"/>	<input type="checkbox"/>	<input type="checkbox"/>	<input type="checkbox"/>	<input type="checkbox"/>	<input type="checkbox"/>	<input type="checkbox"/>	<input type="checkbox"/>	<input type="checkbox"/>	<input type="checkbox"/>	190.00#	3369	279
MCO94																	
Outside Back, 90° Curve, 48" High-Back - Non-contrast																	
<ul style="list-style-type: none"> • Non-contrast C.O.M = 6.75 yds • Gangers included to gang to other High-Back models. • Ganging to backless units or High-Back back to side ganging (specify kit separately) • Does not gang with 32" Low-Back units • Cannot be retrofitted to 60" model • If Byrne Interlink®IQ Power is specified, an additional jumper is always included due to product size, impacting total count for one infeed. See Planning Guide for more information. • All base models have foot leveling capacity • Removable seat design, debris clean-out location, and painted wood base to protect against liquids. • Overall Dimensions: • W=76.5" D=26" H=48" Seat Dimensions: • D=18.5" H=18" 																	
A B C D E F G H I J K L																	

HOW TO ORDER

- Indicate the following information on order form:
- Quantity of each item.
 - Model number, including options. See "How To Build a Model Number".
 - Any special service required.

Note: • The indicates that a choice is required.
• The absence of the indicates that no choice is required.
• Alpha-numeric characters in place of indicate that no other alternatives are available.

HOW TO BUILD A MODEL NUMBER

- A** Select basic model.
- B** Select non-contrast or fabric contrast 1. Refer to ki.com/fabrics.
• For yardage pricing, see Fabric Yardage Pricing page
- C** Select power option.
WP - With power
NP - No power
- D** Select power type.
DCP - Byrne Interlink IQ System w/Mini-Tap module OR jumper (Interlink IQ Infeed to power Interlink IQ Systems ordered separately)
RPT - Mini-Tap power module w/3-prong plug; add \$314
- E** Select Mini-Tap® module w/3-prong plug location.
LFFP - Left front facing power
LRFP - Left rear facing power
RFFP - Right front facing power
RRFP - Right rear facing power

- F** Select Byrne Interlink®IQ System type.
DCJ - Byrne Interlink IQ System jumper only; add \$183
DSMOD - Byrne Interlink IQ System w/Mini-Tap module
- G** Select Byrne Interlink®IQ System w/Mini-Tap® module quantity.
MOD4 - Four modules; add \$1705
MOD1 - One module; add \$495
MOD3 - Three modules; add \$1301
MOD2 - Two Modules; add \$899
- H** Select Byrne Interlink®IQ System w/Mini-Tap® module location(s).
LFLR - Left front, left rear facing power
LFRF - Left front, right front facing power
LFRR - Left front, right rear facing power
LRRF - Left rear, right front facing power
LRRR - Left rear, right rear facing power
RRRF - Right rear, right front facing power
LFRFLRRR - Left front, right front, left rear, right rear facing power
LFLLRRR - Left front, left rear, right rear facing power
LFRFLR - Left front, right front, left rear facing power
LFRFRR - Left front, right front, right rear facing power

- I** Select power module color.
MPB - Black power module
MPS - Silver power module
MPW - White power module
- J** Select wood feet finish. Refer to the **Product Color Options** page in this price list.
- K** Select brushed aluminum feet finish. Refer to the **Product Color Options** page in this price list.
- L** Select moisture barrier.
MB - Moisture barrier
NMB - No moisture barrier
 See pricing column for moisture barrier upcharge.
- RFLRRR** - Right front, left rear, right rear facing power
LFFP - Left front facing power
LRFP - Left rear facing power
RFFP - Right front facing power
RRFP - Right rear facing power

INFORMATION

The removable seat design of MyPlace™ High-Back units allows for ease of installation and clean out, as well as inspection of electrical components. MyPlace™ High-Back offers power modules with a 3-prong plug (ETL Listed) or Byrne Interlink® IQ electrical system (an ETL Listed Furniture Power Distribution Unit, electrical system.) Because the system is ETL Listed, MyPlace™ Lounge has not been listed. All 48" high-back models can be used as free-standing units or can be ganged to other 48" high-back or 60" high-back models. Gangers are included for traditional lineal ganging with 48" high-back models, however, please note installing concealed gangers on 48" high-back models will permanently alter upholstery. Please see Installation Guide for further information related to ganging.

SPECIAL SERVICES

Special Carton Marking

With specially marked information N/C

Shipping
Ships **assembled, FOB High Point, NC 27263, freight prepaid.** Freight class 250.

Specifications and prices are subject to change without prior notice.



Features	MODEL NUMBER														Approx. Packaged Weight	Delivered Pricing	Moisture Barrier add to list price		
	Basic Model	Non-Cont or Fabric Cont 1	Fab Con 2	Fab Con 3	Pwr Opt	Pwr Type	MT Pwr Loc	IQ Pwr Type	IQ Mod Qty	IQ Pwr Loc	Pwr Color	Wd Feet Fin	Alum Feet Fin	Moist Barr					
concealed glides shown	Concealed Glide	MCOH94/CGL/FC	<input type="checkbox"/>	<input type="checkbox"/>	<input type="checkbox"/>	<input type="checkbox"/>	<input type="checkbox"/>	<input type="checkbox"/>	<input type="checkbox"/>	<input type="checkbox"/>	<input type="checkbox"/>	<input type="checkbox"/>	<input type="checkbox"/>	<input type="checkbox"/>	<input type="checkbox"/>	<input type="checkbox"/>	190.00#	\$ 3300	\$ 279
	Poly Feet	MCOH94/PFT/FC	<input type="checkbox"/>	<input type="checkbox"/>	<input type="checkbox"/>	<input type="checkbox"/>	<input type="checkbox"/>	<input type="checkbox"/>	<input type="checkbox"/>	<input type="checkbox"/>	<input type="checkbox"/>	<input type="checkbox"/>	<input type="checkbox"/>	<input type="checkbox"/>	<input type="checkbox"/>	<input type="checkbox"/>	190.00#	3300	279
	Wood Feet	MCOH94/WFT/FC	<input type="checkbox"/>	<input type="checkbox"/>	<input type="checkbox"/>	<input type="checkbox"/>	<input type="checkbox"/>	<input type="checkbox"/>	<input type="checkbox"/>	<input type="checkbox"/>	<input type="checkbox"/>	<input type="checkbox"/>	<input type="checkbox"/>	<input type="checkbox"/>	<input type="checkbox"/>	<input type="checkbox"/>	190.00#	3429	279
	Aluminum Feet	MCOH94/AFT/FC	<input type="checkbox"/>	<input type="checkbox"/>	<input type="checkbox"/>	<input type="checkbox"/>	<input type="checkbox"/>	<input type="checkbox"/>	<input type="checkbox"/>	<input type="checkbox"/>	<input type="checkbox"/>	<input type="checkbox"/>	<input type="checkbox"/>	<input type="checkbox"/>	<input type="checkbox"/>	<input type="checkbox"/>	190.00#	3429	279

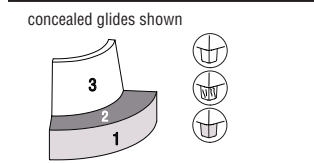

MCO94
Outside Back, 90° Curve, 48" High-Back - Contrast

- 1 = Base (Contrast 1) C.O.M. = 2.5 yd
- 2 = Seat (Contrast 2) C.O.M. = 1.75 yd
- 3 = Back (Contrast 3) C.O.M. = 3.75 yd
- Gangers included to gang to other High-Back models.
- Ganging to backless units or High-Back back to side ganging (specify kit separately)
- Does not gang with 32" Low-Back units
- Cannot be retrofitted to 60" model
- If Byrne Interlink®IQ Power is specified, an additional jumper is always included due to product size, impacting total count for one infeed. See Planning Guide for more information.
- All base models have foot leveling capacity
- Removable seat design, debris clean-out location, and painted wood base to protect against liquids.
- Overall Dimensions:
• W=76.5" D=26" H=48"
- Seat Dimensions:
• D=18.5" H=18"

HOW TO ORDER
Indicate the following information on order form:
1. Quantity of each item.
2. Model number, including options. See "How To Build a Model Number".
3. Any special service required.

Note: • The indicates that a choice is required.
• The absence of the indicates that no choice is required.
• Alpha-numeric characters in place of indicate that no other alternatives are available.

HOW TO BUILD A MODEL NUMBER

A Select basic model.

B Select non-contrast or fabric contrast 1. Refer to ki.com/fabrics.
• For yardage pricing, see Fabric Yardage Pricing page

C Select fabric contrast 2. Refer to ki.com/fabrics.
• For yardage pricing, see Fabric Yardage Pricing page

D Select fabric contrast 3. Refer to ki.com/fabrics.
• For yardage pricing, see Fabric Yardage Pricing page

E Select power option.
WP - With power
NP - No power

F Select power type.
DCP - Byrne Interlink IQ System w/Mini-Tap module OR jumper (Interlink IQ Infeed to power

Interlink IQ Systems ordered separately)
RPT - Mini-Tap power module w/3-prong plug; add \$314

G Select Mini-Tap® module w/3-prong plug location.
LFPP - Left front facing power
LRFP - Left rear facing power
RFFP - Right front facing power
RRFP - Right rear facing power

H Select Byrne Interlink®IQ System type.
DCJ - Byrne Interlink IQ System jumper only; add \$183
DSMOD - Byrne Interlink IQ System w/Mini-Tap module

I Select Byrne Interlink®IQ System w/Mini-Tap® module quantity.
MOD4 - Four modules; add \$1705
MOD1 - One module; add \$495
MOD3 - Three modules; add \$1301
MOD2 - Two Modules; add \$899

J Select Byrne Interlink®IQ System w/Mini-Tap® module location(s).
LFRFLRRR - Left front, right front, left rear, right rear facing power

rear facing power
LFLR - Left front, left rear facing power
LFRF - Left front, right front facing power
LFRR - Left front, right rear facing power
LRRF - Left rear, right front facing power
LRRR - Left rear, right rear facing power
RRRF - Right rear, right front facing power
LFLRRR - Left front, left rear, right rear facing power
LFRFLR - Left front, right front, left rear facing power
LFRFRR - Left front, right front, right rear facing power
RFLRRR - Right front, left rear, right rear facing power
LFPP - Left front facing power
LRFP - Left rear facing power
RFFP - Right front facing power
RRFP - Right rear facing power

K Select power module color.
MPB - Black power module
MPS - Silver power module
MPW - White power module

L Select wood feet finish. Refer to the **Product Color Options** page in this price list.

M Select brushed aluminum feet finish. Refer to the **Product Color Options** page in this price list.

N Select moisture barrier.
MB - Moisture barrier
NMB - No moisture barrier
See pricing column for moisture barrier upcharge.

INFORMATION
The removable seat design of MyPlace™ High-Back units allows for ease of installation and clean out, as well as inspection of electrical components. MyPlace™ High-Back offers power modules with a 3-prong plug (ETL Listed) or Byrne Interlink® IQ electrical system (an ETL Listed Furniture Power Distribution Unit, electrical system.) Because the system is ETL Listed, MyPlace™ Lounge has not been listed. All 48" high-back models can be used as free-standing units or can be ganged to other 48" high-back or 60" high-back models. Gangers are included for traditional lineal ganging with 48" high-back models, however, please note installing concealed gangers on 48" high-back models will permanently alter upholstery. Please see Installation Guide for further information related to ganging.

SPECIAL SERVICES
Special Carton Marking
With specially marked information N/C

Shipping
Ships assembled, FOB High Point, NC 27263, freight prepaid. Freight class 250.

Specifications and prices are subject to change without prior notice.

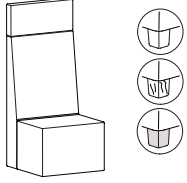

Features	MODEL NUMBER													Approx. Packaged Weight	Delivered Pricing	Moisture Barrier add to list price			
	Basic Model	Non-Cont or Fabric Cont 1	Pwr Opt	Pwr Type	MT Pwr Loc	IQ Pwr Type	IQ Mod Qty	IQ Pwr Loc	Pwr Color	Wd Feet Fin	Alum Feet Fin	Moist Barr							
concealed glides shown 	Concealed Glides	MSQH60/CGL/NC	<input type="checkbox"/>	<input type="checkbox"/>	<input type="checkbox"/>	<input type="checkbox"/>	<input type="checkbox"/>	<input type="checkbox"/>	<input type="checkbox"/>	<input type="checkbox"/>	<input type="checkbox"/>	<input type="checkbox"/>	<input type="checkbox"/>			<input type="checkbox"/>	120.00#	\$ 2636	\$ 257
	Poly Feet	MSQH60/PFT/NC	<input type="checkbox"/>	<input type="checkbox"/>	<input type="checkbox"/>	<input type="checkbox"/>	<input type="checkbox"/>	<input type="checkbox"/>	<input type="checkbox"/>	<input type="checkbox"/>	<input type="checkbox"/>	<input type="checkbox"/>	<input type="checkbox"/>			<input type="checkbox"/>	120.00#	2636	257
	Wood Feet	MSQH60/WFT/NC	<input type="checkbox"/>	<input type="checkbox"/>	<input type="checkbox"/>	<input type="checkbox"/>	<input type="checkbox"/>	<input type="checkbox"/>	<input type="checkbox"/>	<input type="checkbox"/>	<input type="checkbox"/>	<input type="checkbox"/>	<input type="checkbox"/>	<input type="checkbox"/>		<input type="checkbox"/>	120.00#	2762	257
	Aluminum Feet	MSQH60/AFT/NC	<input type="checkbox"/>	<input type="checkbox"/>	<input type="checkbox"/>	<input type="checkbox"/>	<input type="checkbox"/>	<input type="checkbox"/>	<input type="checkbox"/>	<input type="checkbox"/>	<input type="checkbox"/>	<input type="checkbox"/>	<input type="checkbox"/>	<input type="checkbox"/>	<input type="checkbox"/>	<input type="checkbox"/>	120.00#	2762	257

- MSQ60
Lounge Chair, 60" High-Back - Non-contrast
- Non-contrast C.O.M = 5.25 yds
 - Gangers included to gang to other 60" High-Back models.
 - Ganging to backless units or High-Back back to side ganging (specify kit separately)
 - Does not gang with 32" Low-Back units
 - Cannot be retrofitted to 48" model
 - All base models have foot leveling capacity
 - Removable seat design, debris clean-out location, and painted wood base to protect against liquids.
 - Overall Dimensions:
 - W=26" D=26" H=60"
 - Seat Dimensions:
 - D=18.5" H=18"

HOW TO ORDER

Indicate the following information on order form:

1. Quantity of each item.
2. Model number, including options. See "How To Build a Model Number".
3. Any special service required.

Note:

- The indicates that a choice is required.
- The absence of the indicates that no choice is required.
- Alpha-numeric characters in place of indicate that no other alternatives are available.

HOW TO BUILD A MODEL NUMBER

A Select basic model.

B Select non-contrast or fabric contrast 1. Refer to ki.com/fabrics.
• For yardage pricing, see Fabric Yardage Pricing page

C Select power option.
NP - No power
WP - With power

D Select power type.
DCP - Byrne Interlink IQ System w/Mini-Tap module OR jumper (Interlink IQ Infeed to power Interlink IQ Systems ordered seperately)
RPT - Mini-Tap power module w/3-prong plug; add \$314

E Select Mini-Tap® module w/3-prong plug location.
LFFP - Left front facing power
LRFP - Left rear facing power
RFFP - Right front facing power
RRFP - Right rear facing power

F Select Byrne Interlink®IQ System type.
DCJ - Byrne Interlink IQ System jumper only; add \$124
DSMOD - Byrne Interlink IQ System w/Mini-Tap module

G Select Byrne Interlink®IQ System w/Mini-Tap® module quantity.
MOD1 - One module; add \$404
MOD2 - Two Modules; add \$807
MOD3 - Three modules; add \$1211
MOD4 - Four modules; add \$1614

H Select Byrne Interlink®IQ System w/Mini-Tap® module quantity.
LFFP - Left front facing power
LRFP - Left rear facing power
RFFP - Right front facing power
RRFP - Right rear facing power
LFLR - Left front, left rear facing power
LFRF - Left front, right front facing power
LFRR - Left front, right rear facing power
LRRF - Left rear, right front facing power
LRRR - Left rear, right rear facing power
RRRF - Right rear, right front facing power
LFLRRR - Left front, left rear, right rear facing power
LFRFLR - Left front, right front, left rear facing power
LFRFRR - Left front, right front, right rear facing power

RFLRRR - Right front, left rear, right rear facing power
LFRFLRRR - Left front, right front, left rear, right rear facing power

I Select module color.
MPB - Black power module
MPS - Silver power module
MPW - White power module

J Select wood feet finish. Refer to the **Product Color Options** page in this price list.

K Select brushed aluminum feet finish. Refer to the **Product Color Options** page in this price list.

L Select moisture barrier.
MB - Moisture barrier
NMB - No moisture barrier
See pricing column for moisture barrier upcharge.

INFORMATION

The removable seat design of MyPlace™ High-Back units allows for ease of installation and clean out, as well as inspection of electrical components. MyPlace™ High-Back offers UL recognized power components and an ETL-Listed power system (Byrne Interlink® IQ). MyPlace™ Lounge is not a UL listed Office Furnishing.

SPECIAL SERVICES

Special Carton Marking
With specially marked information N/C

Shipping
Ships **partially assembled, FOB High Point, NC 27263, freight prepaid.** Freight class 250.

Specifications and prices are subject to change without prior notice.



Features	MODEL NUMBER														Approx. Packaged Weight	Delivered Pricing	Moisture Barrier add to list price	
	Basic Model	Non-Cont or Fabric Cont 1	Fabric Cont 2	Fabric Cont 3	Pwr Opt	Pwr Type	MT Pwr Loc	IQ Pwr Type	IQ Mod Qty	IQ Pwr Loc	Pwr Color	Wd Feet Fin	Alum Feet Fin	Moist Barr				
concealed glides shown Concealed Glides	MSQH60/CGL/FC	<input type="checkbox"/>	<input type="checkbox"/>	<input type="checkbox"/>	<input type="checkbox"/>	<input type="checkbox"/>	<input type="checkbox"/>	<input type="checkbox"/>	<input type="checkbox"/>	<input type="checkbox"/>	<input type="checkbox"/>	<input type="checkbox"/>	<input type="checkbox"/>	<input type="checkbox"/>	<input type="checkbox"/>	120.00#	\$ 2683	\$ 257
Poly Feet	MSQH60/PFT/FC	<input type="checkbox"/>	<input type="checkbox"/>	<input type="checkbox"/>	<input type="checkbox"/>	<input type="checkbox"/>	<input type="checkbox"/>	<input type="checkbox"/>	<input type="checkbox"/>	<input type="checkbox"/>	<input type="checkbox"/>	<input type="checkbox"/>	<input type="checkbox"/>	<input type="checkbox"/>	<input type="checkbox"/>	120.00#	2683	257
Wood Feet	MSQH60/WFT/FC	<input type="checkbox"/>	<input type="checkbox"/>	<input type="checkbox"/>	<input type="checkbox"/>	<input type="checkbox"/>	<input type="checkbox"/>	<input type="checkbox"/>	<input type="checkbox"/>	<input type="checkbox"/>	<input type="checkbox"/>	<input type="checkbox"/>	<input type="checkbox"/>	<input type="checkbox"/>	<input type="checkbox"/>	120.00#	2811	257
Aluminum Feet	MSQH60/AFT/FC	<input type="checkbox"/>	<input type="checkbox"/>	<input type="checkbox"/>	<input type="checkbox"/>	<input type="checkbox"/>	<input type="checkbox"/>	<input type="checkbox"/>	<input type="checkbox"/>	<input type="checkbox"/>	<input type="checkbox"/>	<input type="checkbox"/>	<input type="checkbox"/>	<input type="checkbox"/>	<input type="checkbox"/>	120.00#	2811	257

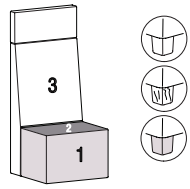

MSQ60
Lounge Chair, 60" High-Back - Contrast

- 1 = Base (Contrast 1) C.O.M. = 1.25 yd
- 2 = Seat (Contrast 2) C.O.M. = .75 yd
- 3 = Back (Contrast 3) C.O.M. = 3.5 yd
- Gangers included to gang to other 60" High-Back models.
- Ganging to backless units or High-Back back to side ganging (specify kit separately)
- Does not gang with 32" Low-Back units
- Cannot be retrofitted to 48" model
- All base models have foot leveling capacity
- Removable seat design, debris clean-out location, and painted wood base to protect against liquids.
- Overall Dimensions:
- W=26" D=26" H=60"
- Seat Dimensions:
- D=18.5" H=18"

HOW TO ORDER

- Indicate the following information on order form:
- Quantity of each item.
 - Model number, including options. See "How To Build a Model Number".
 - Any special service required.

Note: • The indicates that a choice is required.
• The absence of the indicates that no choice is required.
• Alpha-numeric characters in place of indicate that no other alternatives are available.

HOW TO BUILD A MODEL NUMBER

- A** Select basic model.
- B** Select non-contrast or fabric contrast 1. Refer to ki.com/fabrics.
• For yardage pricing, see Fabric Yardage Pricing page
- C** Select fabric contrast 2. Refer to ki.com/fabrics.
• For yardage pricing, see Fabric Yardage Pricing page
- D** Select fabric contrast 3. Refer to ki.com/fabrics.
• For yardage pricing, see Fabric Yardage Pricing page
- E** Select power option.
NP - No power
WP - With power
- F** Select power type.
DCP - Byrne Interlink IQ System w/Mini-Tap module QR jumper (Interlink IQ Infeed to power Interlink IQ Systems ordered seperately)
RPT - Mini-Tap power module w/3-prong plug; add \$314

- G** Select Mini-Tap® module w/3-prong plug location.
LFFP - Left front facing power
LRFP - Left rear facing power
RFFP - Right front facing power
RRFP - Right rear facing power

- H** Select Byrne Interlink®IQ System type.
DCJ - Byrne Interlink IQ System jumper only; add \$124
DSMOD - Byrne Interlink IQ System w/Mini-Tap module

- I** Select Byrne Interlink®IQ System w/Mini-Tap® module quantity.
MOD1 - One module; add \$404
MOD2 - Two Modules; add \$807
MOD3 - Three modules; add \$1211
MOD4 - Four modules; add \$1614

- J** Select Byrne Interlink®IQ System w/Mini-Tap® module quantity.
LFFP - Left front facing power
LRFP - Left rear facing power
RFFP - Right front facing power

- RRFP** - Right rear facing power
- LFLR** - Left front, left rear facing power
- LFRR** - Left front, right front facing power
- LRFR** - Left rear, right front facing power
- LRRR** - Left rear, right rear facing power
- RRRR** - Right rear, right front facing power
- LFLRRR** - Left front, left rear, right rear facing power
- LFRRFLR** - Left front, right front, left rear facing power
- LFRFRFR** - Left front, right front, right rear facing power
- RFLRRR** - Right front, left rear, right rear facing power
- LFRRFLRRR** - Left front, right front, left rear, right rear facing power

- K** Select module color.
MPB - Black power module
MPS - Silver power module
MPW - White power module

- L** Select wood feet finish. Refer to the **Product Color Options** page in this price list.

- M** Select brushed aluminum feet finish. Refer to the **Product Color Options** page in this price list.

- N** Select moisture barrier.

- MB** - Moisture barrier
 - NMB** - No moisture barrier
- See pricing column for moisture barrier upcharge.

INFORMATION

The removable seat design of MyPlace™ High-Back units allows for ease of installation and clean out, as well as inspection of electrical components. MyPlace™ High-Back offers UL recognized power components and an ETL-Listed power system (Byrne Interlink® IQ). MyPlace™ Lounge is not a UL listed Office Furnishing.

SPECIAL SERVICES

Special Carton Marking
With specially marked information N/C

Shipping
Ships **partially assembled, FOB High Point, NC 27263, freight prepaid.** Freight class 250.

Specifications and prices are subject to change without prior notice.



Features	MODEL NUMBER												Approx. Packaged Weight	Delivered Pricing	Moisture Barrier add to list price	
	Basic Model	Non-Cont or Fabric Cont 1	Pwr Opt	Pwr Type	MT Pwr Loc	IQ Pwr Type	IQ Mod Qty	IQ Pwr Loc	Pwr Color	Wd Feet Fin	Alum Feet Fin	Moist Barr				
concealed glides shown	Concealed Glides	MRBH60/CGL/NC	<input type="checkbox"/>	<input type="checkbox"/>	<input type="checkbox"/>	<input type="checkbox"/>	<input type="checkbox"/>	<input type="checkbox"/>	<input type="checkbox"/>	<input type="checkbox"/>	<input type="checkbox"/>	<input type="checkbox"/>	<input type="checkbox"/>	180.00#	\$ 3393	\$ 279
	Poly Feet	MRBH60/PFT/NC	<input type="checkbox"/>	<input type="checkbox"/>	<input type="checkbox"/>	<input type="checkbox"/>	<input type="checkbox"/>	<input type="checkbox"/>	<input type="checkbox"/>	<input type="checkbox"/>	<input type="checkbox"/>	<input type="checkbox"/>	<input type="checkbox"/>	180.00#	3393	279
	Wood Feet	MRBH60/WFT/NC	<input type="checkbox"/>	<input type="checkbox"/>	<input type="checkbox"/>	<input type="checkbox"/>	<input type="checkbox"/>	<input type="checkbox"/>	<input type="checkbox"/>	<input type="checkbox"/>	<input type="checkbox"/>	<input type="checkbox"/>	<input type="checkbox"/>	180.00#	3518	279
	Aluminum Feet	MRBH60/AFT/NC	<input type="checkbox"/>	<input type="checkbox"/>	<input type="checkbox"/>	<input type="checkbox"/>	<input type="checkbox"/>	<input type="checkbox"/>	<input type="checkbox"/>	<input type="checkbox"/>	<input type="checkbox"/>	<input type="checkbox"/>	<input type="checkbox"/>	180.00#	3518	279

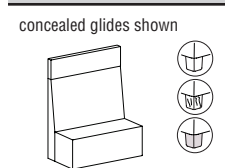

MRB60
Rectangle with 60" High-Back - Non-contrast

- Non-contrast C.O.M = 6.75 yds
- Gangers included to gang to other 60" high-back models.
- Ganging to backless units or high-back back to side ganging (specify kit separately)
- Does not gang with 32" low-back units
- Cannot be retrofitted to 48" model
- All base models have foot leveling capacity
- Removable seat design, debris clean-out location, and painted wood base to protect against liquids.
- Overall Dimensions:
• W=48" D=26" H=60"
- Seat Dimensions:
• D=18.5" H=18"

HOW TO ORDER

Indicate the following information on order form:

1. Quantity of each item.
2. Model number, including options. See "How To Build a Model Number".
3. Any special service required.

Note:

- The indicates that a choice is required.
- The absence of the indicates that no choice is required.
- Alpha-numeric characters in place of indicate that no other alternatives are available.

HOW TO BUILD A MODEL NUMBER

A Select basic model.

B Select non-contrast or fabric contrast 1. Refer to ki.com/fabrics.
 • For yardage pricing, see Fabric Yardage Pricing page

C Select power option.
NP - No power
WP - With power

D Select power type.
DCP - Byrne Interlink IQ System w/Mini-Tap module OR jumper (Interlink IQ Infeed to power Interlink IQ Systems ordered seperately)
RPT - Mini-Tap power module w/3-prong plug; add \$314

E Select Mini-Tap® module w/3-prong plug location.
LFFP - Left front facing power
LRFP - Left rear facing power
RFFP - Right front facing power
RRFP - Right rear facing power

F Select Byrne Interlink®IQ System type.
DCJ - Byrne Interlink IQ System jumper only; add \$124
DSMOD - Byrne Interlink IQ System w/Mini-Tap module quantity.
MOD1 - One module; add \$404
MOD2 - Two Modules; add \$807
MOD3 - Three modules; add \$1211
MOD4 - Four modules; add \$1614

G Select Byrne Interlink®IQ System w/Mini-Tap® module quantity.
LFFP - Left front facing power
LRFP - Left rear facing power
RFFP - Right front facing power
RRFP - Right rear facing power
LFLR - Left front, left rear facing power
LFRF - Left front, right front facing power
LFRR - Left front, right rear facing power
LRRF - Left rear, right front facing power
LRRR - Left rear, right rear facing power
RRRF - Right rear, right front facing power
LFLRRR - Left front, left rear, right rear facing power
LFRFLR - Left front, right front, left rear facing power
LFRFRR - Left front, right front, right rear facing power

H Select Byrne Interlink®IQ System w/Mini-Tap® module quantity.
RFLRRR - Right front, left rear, right rear facing power
LFRFLRRR - Left front, right front, left rear, right rear facing power

I Select module color.
MPB - Black power module
MPS - Silver power module
MPW - White power module

J Select wood feet finish. Refer to the **Product Color Options** page in this price list.

K Select brushed aluminum feet finish. Refer to the **Product Color Options** page in this price list.

L Select moisture barrier.
MB - Moisture barrier
NMB - No moisture barrier
 See pricing column for moisture barrier upcharge.

INFORMATION

The removable seat design of MyPlace™ High-Back units allows for ease of installation and clean out, as well as inspection of electrical components. MyPlace™ High-Back offers UL recognized power components and an ETL-Listed power system (Byrne Interlink® IQ). MyPlace™ Lounge is not a UL listed Office Furnishing.

SPECIAL SERVICES

Special Carton Marking
 With specially marked information N/C

Shipping
 Ships **partially assembled, FOB High Point, NC 27263, freight prepaid.** Freight class 250.

Specifications and prices are subject to change without prior notice.



Features	MODEL NUMBER														Approx. Packaged Weight	Delivered Pricing	Moisture Barrier add to list price		
	Basic Model	Non-Cont or Fabric Cont 1	Fab Con 2	Fab Con 3	Pwr Opt	Pwr Type	MT Pwr Loc	IQ Pwr Type	IQ Mod Qty	IQ Pwr Loc	Pwr Color	Wd Feet Fin	Alum Feet Fin	Moist Barr					
concealed glides shown	Concealed Glides	MRBH60/CGL/FC	<input type="checkbox"/>	<input type="checkbox"/>	<input type="checkbox"/>	<input type="checkbox"/>	<input type="checkbox"/>	<input type="checkbox"/>	<input type="checkbox"/>	<input type="checkbox"/>	<input type="checkbox"/>	<input type="checkbox"/>	<input type="checkbox"/>	<input type="checkbox"/>	<input type="checkbox"/>	<input type="checkbox"/>	180.00#	\$ 3454	\$ 279
	Poly Feet	MRBH60/PFT/FC	<input type="checkbox"/>	<input type="checkbox"/>	<input type="checkbox"/>	<input type="checkbox"/>	<input type="checkbox"/>	<input type="checkbox"/>	<input type="checkbox"/>	<input type="checkbox"/>	<input type="checkbox"/>	<input type="checkbox"/>	<input type="checkbox"/>	<input type="checkbox"/>	<input type="checkbox"/>	<input type="checkbox"/>	180.00#	3454	279
	Wood Feet	MRBH60/WFT/FC	<input type="checkbox"/>	<input type="checkbox"/>	<input type="checkbox"/>	<input type="checkbox"/>	<input type="checkbox"/>	<input type="checkbox"/>	<input type="checkbox"/>	<input type="checkbox"/>	<input type="checkbox"/>	<input type="checkbox"/>	<input type="checkbox"/>	<input type="checkbox"/>	<input type="checkbox"/>	<input type="checkbox"/>	180.00#	3582	279
	Aluminum Feet	MRBH60/AFT/FC	<input type="checkbox"/>	<input type="checkbox"/>	<input type="checkbox"/>	<input type="checkbox"/>	<input type="checkbox"/>	<input type="checkbox"/>	<input type="checkbox"/>	<input type="checkbox"/>	<input type="checkbox"/>	<input type="checkbox"/>	<input type="checkbox"/>	<input type="checkbox"/>	<input type="checkbox"/>	<input type="checkbox"/>	180.00#	3582	279

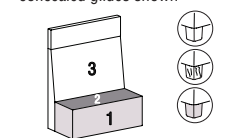

- MRB60
Rectangle with 60" High-Back - Contrast
- 1 = Base (Contrast 1) C.O.M. = 2 yd
 - 2 = Seat (Contrast 2) C.O.M. = .75 yd
 - 3 = Back (Contrast 3) C.O.M. = 5 yd
 - Gangers included to gang to other 60" High-Back models.
 - Ganging to backless units or High-Back back to side ganging (specify kit separately)
 - Does not gang with 32" Low-Back units
 - Cannot be retrofitted to 48" model
 - All base models have foot leveling capacity
 - Removable seat design, debris clean-out location, and painted wood base to protect against liquids.
 - Overall Dimensions:
 - W=48" D=26" H=60"
 - Seat Dimensions:
 - D=18.5" H=18"

HOW TO ORDER

Indicate the following information on order form:

1. Quantity of each item.
2. Model number, including options. See "How To Build a Model Number".
3. Any special service required.

Note:

- The indicates that a choice is required.
- The absence of the indicates that no choice is required.
- Alpha-numeric characters in place of indicate that no other alternatives are available.

HOW TO BUILD A MODEL NUMBER

A Select basic model.

B Select non-contrast or fabric contrast 1. Refer to ki.com/fabrics.
• For yardage pricing, see Fabric Yardage Pricing page

C Select fabric contrast 2. Refer to ki.com/fabrics.
• For yardage pricing, see Fabric Yardage Pricing page

D Select fabric contrast 3. Refer to ki.com/fabrics.
• For yardage pricing, see Fabric Yardage Pricing page

E Select power option.
NP - No power
WP - With power

F Select power type.
DCP - Byrne Interlink IQ System w/Mini-Tap module OR jumper (Interlink IQ Infeed to power Interlink IQ Systems ordered seperately)
RPT - Mini-Tap power module w/3-prong plug; add \$314

G Select Mini-Tap® module w/3-prong plug location.
LFFP - Left front facing power
LRFP - Left rear facing power
RFFP - Right front facing power
RRFP - Right rear facing power

H Select Byrne Interlink®IQ System type.
DCJ - Byrne Interlink IQ System jumper only; add \$124
DSMOD - Byrne Interlink IQ System w/Mini-Tap module

I Select Byrne Interlink®IQ System w/Mini-Tap® module quantity.
MOD1 - One module; add \$404
MOD2 - Two Modules; add \$807
MOD3 - Three modules; add \$1211
MOD4 - Four modules; add \$1614

J Select Byrne Interlink®IQ System w/Mini-Tap® module quantity.
LFFP - Left front facing power
LRFP - Left rear facing power
RFFP - Right front facing power
RRFP - Right rear facing power
LFLR - Left front, left rear facing power
LFRF - Left front, right front facing power

K Select module color.
MPB - Black power module
MPS - Silver power module
MPW - White power module

L Select wood feet finish. Refer to the **Product Color Options** page in this price list.

M Select brushed aluminum feet finish. Refer to the **Product Color Options** page in this price list.

N Select moisture barrier.
MB - Moisture barrier
NMB - No moisture barrier
See pricing column for moisture barrier upcharge.

INFORMATION

The removable seat design of MyPlace™ High-Back units allows for ease of installation and clean out, as well as inspection of electrical components. MyPlace™ High-Back offers UL recognized power components and an ETL-Listed power system (Byrne Interlink® IQ). MyPlace™ Lounge is not a UL listed Office Furnishing.

SPECIAL SERVICES

Special Carton Marking
With specially marked information N/C

Shipping
Ships **partially assembled, FOB High Point, NC 27263, freight prepaid.** Freight class 250.

Specifications and prices are subject to change without prior notice.



Features	MODEL NUMBER													Approx. Packaged Weight	Delivered Pricing	Moisture Barrier add to list price		
	Basic Model	Non-Contrast or Fabric Cont 1	Pwr Opt	Pwr Type	MT Pwr Loc	IQ Pwr Type	IQ Mod Qty	IQ Pwr Loc	Power Color	Wd Feet Fin	Alum Feet Fin	Moist Barr						
concealed glides shown	Concealed Glides	MECH60L/CGL/NC	<input type="checkbox"/>	<input type="checkbox"/>	<input type="checkbox"/>	<input type="checkbox"/>	<input type="checkbox"/>	<input type="checkbox"/>	<input type="checkbox"/>	<input type="checkbox"/>	<input type="checkbox"/>	<input type="checkbox"/>	<input type="checkbox"/>			185.00#	\$ 3825	\$ 295
	Poly Feet	MECH60L/PFT/NC	<input type="checkbox"/>	<input type="checkbox"/>	<input type="checkbox"/>	<input type="checkbox"/>	<input type="checkbox"/>	<input type="checkbox"/>	<input type="checkbox"/>	<input type="checkbox"/>	<input type="checkbox"/>	<input type="checkbox"/>	<input type="checkbox"/>			185.00#	3825	295
	Wood Feet	MECH60L/WFT/NC	<input type="checkbox"/>	<input type="checkbox"/>	<input type="checkbox"/>	<input type="checkbox"/>	<input type="checkbox"/>	<input type="checkbox"/>	<input type="checkbox"/>	<input type="checkbox"/>	<input type="checkbox"/>	<input type="checkbox"/>	<input type="checkbox"/>			185.00#	3951	295
	Aluminum Feet	MECH60L/AFT/NC	<input type="checkbox"/>	<input type="checkbox"/>	<input type="checkbox"/>	<input type="checkbox"/>	<input type="checkbox"/>	<input type="checkbox"/>	<input type="checkbox"/>	<input type="checkbox"/>	<input type="checkbox"/>	<input type="checkbox"/>	<input type="checkbox"/>			185.00#	3951	295

MEC60
Extended Corner LEFT with 60" High-Back - Non-contrast

- Non-contrast C.O.M = 7.75 yds
- Gangers included to gang to other 60" High-Back models.
- Ganging to backless units or High-Back back to side ganging (specify kit separately)
- Does not gang with 32" Low-Back units
- Cannot be retrofitted to 48" model
- Power cannot be specified on front of unit on closed-end side. Three available power locations.
- All base models have foot leveling capacity
- Removable seat design, debris clean-out location, and painted wood base to protect against liquids.
- Overall Dimensions:
• W=48" D=26" H=60"
- Seat Dimensions:
• D=18.5" H=18"

HOW TO ORDER

Indicate the following information on order form:

1. Quantity of each item.
2. Model number, including options. See "How To Build a Model Number".
3. Any special service required.

Note: • The indicates that a choice is required.
• The absence of the indicates that no choice is required.
• Alpha-numeric characters in place of indicate that no other alternatives are available.

HOW TO BUILD A MODEL NUMBER

A Select basic model.

B Select non-contrast or fabric contrast 1. Refer to ki.com/fabrics.
• For yardage pricing, see Fabric Yardage Pricing page

C Select power option.
NP - No power
WP - With power

D Select power type.
DCP - Byrne Interlink IQ System w/ Mini-Tap module OR jumper (Interlink IQ Infeed to power Interlink IQ Systems ordered seperately)
RPT - Mini-Tap power module w/3-prong plug; add \$314

E Select Mini-Tap® module w/3-prong plug location.
LRFP - Left rear facing power
RFFP - Right front facing power

RRFP - Right rear facing power

F Select Byrne Interlink®IQ System type.
DCJ - Byrne Interlink IQ System jumper only; add \$124
DSMOD - Byrne Interlink IQ System w/Mini-Tap module

G Select Byrne Interlink®IQ System w/Mini-Tap® module quantity.
MOD1 - One module; add \$404
MOD2 - Two Modules; add \$807
MOD3 - Three modules; add \$1211

H Select Byrne Interlink®IQ System w/Mini-Tap® module location(s).
LRFP - Left rear facing power
RFFP - Right front facing power
RRFP - Right rear facing power
LRRF - Left rear, right front facing power
LRRR - Left rear, right rear facing power
RRRF - Right rear, right front facing power
RFLRRR - Right front, left rear, right rear facing power

I Select power module color.
MPB - Black power module
MPS - Silver power module
MPW - White power module

J Select wood feet finish. Refer to the **Product Color Options** page in this price list.

K Select brushed aluminum feet finish. Refer to the **Product Color Options** page in this price list.

L Select moisture barrier.
MB - Moisture barrier
NMB - No moisture barrier
See pricing column for moisture barrier upcharge.

INFORMATION

The removable seat design of MyPlace™ High-Back units allows for ease of installation and clean out, as well as inspection of electrical components. MyPlace™ High-Back offers UL recognized power components and an ETL-Listed power system (Byrne Interlink® IQ). MyPlace™ Lounge is not a UL listed Office Furnishing.

SPECIAL SERVICES

Special Carton Marking
With specially marked information N/C

Shipping
Ships **partially assembled, FOB High Point, NC 27263, freight prepaid.** Freight class 250.

Specifications and prices are subject to change without prior notice.

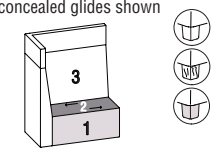

Features	MODEL NUMBER													Approx. Packaged Weight	Delivered Pricing	Moisture Barrier add to list price			
	Basic Model	Non-Cont or Fabric Cont 1	Fab Con 2	Fab Con 3	Pwr Opt	Pwr Type	MT Pwr Loc	IQ Pwr Type	IQ Mod Qty	IQ Pwr Loc	Power Color	Wd Feet Fin	Alum Feet Fin				Moist Barr		
concealed glides shown 	Concealed Glides	MECH60L/CGL/FC	<input type="checkbox"/>	<input type="checkbox"/>	<input type="checkbox"/>	<input type="checkbox"/>	<input type="checkbox"/>	<input type="checkbox"/>	<input type="checkbox"/>	<input type="checkbox"/>	<input type="checkbox"/>	<input type="checkbox"/>	<input type="checkbox"/>	<input type="checkbox"/>	<input type="checkbox"/>	<input type="checkbox"/>	185.00#	\$ 3894	\$ 295
	Poly Feet	MECH60L/PFT/FC	<input type="checkbox"/>	<input type="checkbox"/>	<input type="checkbox"/>	<input type="checkbox"/>	<input type="checkbox"/>	<input type="checkbox"/>	<input type="checkbox"/>	<input type="checkbox"/>	<input type="checkbox"/>	<input type="checkbox"/>	<input type="checkbox"/>	<input type="checkbox"/>	<input type="checkbox"/>	<input type="checkbox"/>	185.00#	3894	295
	Wood Feet	MECH60L/WFT/FC	<input type="checkbox"/>	<input type="checkbox"/>	<input type="checkbox"/>	<input type="checkbox"/>	<input type="checkbox"/>	<input type="checkbox"/>	<input type="checkbox"/>	<input type="checkbox"/>	<input type="checkbox"/>	<input type="checkbox"/>	<input type="checkbox"/>	<input type="checkbox"/>	<input type="checkbox"/>	<input type="checkbox"/>	185.00#	4021	295
	Aluminum Feet	MECH60L/AFT/FC	<input type="checkbox"/>	<input type="checkbox"/>	<input type="checkbox"/>	<input type="checkbox"/>	<input type="checkbox"/>	<input type="checkbox"/>	<input type="checkbox"/>	<input type="checkbox"/>	<input type="checkbox"/>	<input type="checkbox"/>	<input type="checkbox"/>	<input type="checkbox"/>	<input type="checkbox"/>	<input type="checkbox"/>	185.00#	4021	295

MEC60
Extended Corner LEFT with 60" High-Back - Contrast

- 1 = Base (Contrast 1) C.O.M. = 2 yd
- 2 = Seat (Contrast 2) C.O.M. = .75 yd
- 3 = Back (Contrast 3) C.O.M. = 6 yd
- Gangers included to gang to other 60" High-Back models.
- Ganging to backless units or High-Back back to side ganging (specify kit separately)
- Does not gang with 32" Low-Back units
- Cannot be retrofitted to 48" model
- Power cannot be specified on front of unit on closed-end side. Three available power locations.
- All base models have foot leveling capacity
- Removable seat design, debris clean-out location, and painted wood base to protect against liquids.
- Overall Dimensions:
• W=48" D=26" H=60"
- Seat Dimensions:
• D=18.5" H=18"

HOW TO ORDER

Indicate the following information on order form:

- Quantity of each item.
- Model number, including options. See "How To Build a Model Number".
- Any special service required.

Note:

- The indicates that a choice is required.
- The absence of the indicates that no choice is required.
- Alpha-numeric characters in place of indicate that no other alternatives are available.

HOW TO BUILD A MODEL NUMBER

A Select basic model.

B Select non-contrast or fabric contrast 1. Refer to ki.com/fabrics.

- For yardage pricing, see Fabric Yardage Pricing page

C Select fabric contrast 2. Refer to ki.com/fabrics.

- For yardage pricing, see Fabric Yardage Pricing page

D Select fabric contrast 3. Refer to ki.com/fabrics.

- For yardage pricing, see Fabric Yardage Pricing page

E Select power option.

NP - No power
WP - With power

F Select power type.

DCP - Byrne Interlink IQ System w/Mini-

Tap module OR jumper (Interlink IQ Infeed to power Interlink IQ Systems ordered seperately)

RPT - Mini-Tap power module w/3-prong plug; add \$314

G Select Mini-Tap® module w/3-prong plug location.

LRFP - Left rear facing power
RFFP - Right front facing power
RRFP - Right rear facing power

H Select Byrne Interlink®IQ System type.

DCJ - Byrne Interlink IQ System jumper only; add \$124
DSMOD - Byrne Interlink IQ System w/Mini-Tap module

I Select Byrne Interlink®IQ System w/Mini-Tap® module quantity.

MOD1 - One module; add \$404
MOD2 - Two Modules; add \$807
MOD3 - Three modules; add \$1211

J Select Byrne Interlink®IQ System w/Mini-Tap® module location(s).

LRFP - Left rear facing power

RFFP - Right front facing power
RRFP - Right rear facing power
LRRF - Left rear, right front facing power
LRRR - Left rear, right rear facing power
RRRF - Right rear, right front facing power
RFLRRR - Right front, left rear, right rear facing power

K Select power module color.

MPB - Black power module
MPS - Silver power module
MPW - White power module

L Select wood feet finish. Refer to the **Product Color Options** page in this price list.

M Select brushed aluminum feet finish. Refer to the **Product Color Options** page in this price list.

N Select moisture barrier.

MB - Moisture barrier
NMB - No moisture barrier

See pricing column for moisture barrier upcharge.

INFORMATION

The removable seat design of MyPlace™ High-Back units allows for ease of installation and clean out, as well as inspection of electrical components. MyPlace™ High-Back offers UL recognized power components and an ETL-Listed power system (Byrne Interlink® IQ). MyPlace™ Lounge is not a UL listed Office Furnishing.

SPECIAL SERVICES

Special Carton Marking

With specially marked information N/C

Shipping

Ships **partially assembled, FOB High Point, NC 27263, freight prepaid.** Freight class 250.

Specifications and prices are subject to change without prior notice.

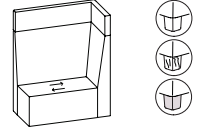

Features	MODEL NUMBER													Approx. Packaged Weight	Delivered Pricing	Moisture Barrier add to list price			
	Basic Model	Non-Cont or Fabric Cont 1	Pwr Opt	Pwr Type	MT Pwr Loc	IQ Pwr Type	IQ Mod Qty	IQ Pwr Loc	Power Color	Wd Feet Fin	Alum Feet Fin	Moist Barr							
concealed glides shown 	Concealed Glides	MECH60R/CGL/NC	<input type="checkbox"/>	<input type="checkbox"/>	<input type="checkbox"/>	<input type="checkbox"/>	<input type="checkbox"/>	<input type="checkbox"/>	<input type="checkbox"/>	<input type="checkbox"/>	<input type="checkbox"/>	<input type="checkbox"/>	<input type="checkbox"/>				185.00#	\$ 3825	\$ 295
	Poly Feet	MECH60R/PFT/NC	<input type="checkbox"/>	<input type="checkbox"/>	<input type="checkbox"/>	<input type="checkbox"/>	<input type="checkbox"/>	<input type="checkbox"/>	<input type="checkbox"/>	<input type="checkbox"/>	<input type="checkbox"/>	<input type="checkbox"/>	<input type="checkbox"/>				185.00#	3825	295
	Wood Feet	MECH60R/WFT/NC	<input type="checkbox"/>	<input type="checkbox"/>	<input type="checkbox"/>	<input type="checkbox"/>	<input type="checkbox"/>	<input type="checkbox"/>	<input type="checkbox"/>	<input type="checkbox"/>	<input type="checkbox"/>	<input type="checkbox"/>	<input type="checkbox"/>				185.00#	3951	295
	Aluminum Feet	MECH60R/AFT/NC	<input type="checkbox"/>	<input type="checkbox"/>	<input type="checkbox"/>	<input type="checkbox"/>	<input type="checkbox"/>	<input type="checkbox"/>	<input type="checkbox"/>	<input type="checkbox"/>	<input type="checkbox"/>	<input type="checkbox"/>	<input type="checkbox"/>				185.00#	3951	295
MEC60																			
Extended Corner RIGHT with 60" High-Back - Non-contrast																			
<ul style="list-style-type: none"> • Non-contrast C.O.M = 7.75 yds • Gangers included to gang to other 60" High-Back models. • Ganging to backless units or High-Back back to side ganging (specify kit separately) • Does not gang with 32" Low-Back units • Cannot be retrofitted to 48" model • Power cannot be specified on front of unit on closed-end side. Three available power locations. • All base models have foot leveling capacity • Removable seat design, debris clean-out location, and painted wood base to protect against liquids. • Overall Dimensions: • W=48" D=26" H=60" • Seat Dimensions: • D=18.5" H=18" 																			
A B C D E F G H I J K L																			

HOW TO ORDER

- Indicate the following information on order form:
1. Quantity of each item.
 2. Model number, including options. See "How To Build a Model Number".
 3. Any special service required.

Note: • The indicates that a choice is required.
 • The absence of the indicates that no choice is required.
 • Alpha-numeric characters in place of indicate that no other alternatives are available.

HOW TO BUILD A MODEL NUMBER

- A** Select basic model.
- B** Select non-contrast or fabric contrast 1. Refer to ki.com/fabrics.
 • For yardage pricing, see Fabric Yardage Pricing page
- C** Select power option.
NP - No power
WP - With power
- D** Select power type.
DCP - Byrne Interlink IQ System w/ Mini-Tap module OR jumper (Interlink IQ Infeed to power Interlink IQ Systems ordered seperately)
RPT - Mini-Tap power module w/3-prong plug; add \$314
- E** Select Mini-Tap® module w/3-prong plug location.
LFFP - Left front facing power
LRFP - Left rear facing power

- RRFP** - Right rear facing power
- F** Select Byrne Interlink®IQ System type.
DCJ - Byrne Interlink IQ System jumper only; add \$124
DSMOD - Byrne Interlink IQ System w/Mini-Tap module
- G** Select Byrne Interlink®IQ System w/Mini-Tap® module quantity.
MOD1 - One module; add \$404
MOD2 - Two Modules; add \$807
MOD3 - Three modules; add \$1211
- H** Select Byrne Interlink®IQ System w/Mini-Tap® module location(s).
LFFP - Left front facing power
LRFP - Left rear facing power
RRFP - Right rear facing power
LFLR - Left front, left rear facing power
LFRR - Left front, right rear facing power
LRRR - Left rear, right rear facing power
LFLRRR - Left front, left rear, right rear facing power

- I** Select power module color.
MPB - Black power module
MPS - Silver power module
MPW - White power module
- J** Select wood feet finish. Refer to the **Product Color Options** page in this price list.
- K** Select brushed aluminum feet finish. Refer to the **Product Color Options** page in this price list.
- L** Select moisture barrier.
MB - Moisture barrier
NMB - No moisture barrier
 See pricing column for moisture barrier upcharge.

INFORMATION

The removable seat design of MyPlace™ High-Back units allows for ease of installation and clean out, as well as inspection of electrical components. MyPlace™ High-Back offers UL recognized power components and an ETL-Listed power system (Byrne Interlink® IQ). MyPlace™ Lounge is not a UL listed Office Furnishing.

SPECIAL SERVICES

Special Carton Marking

With specially marked information N/C

Shipping
 Ships **partially assembled, FOB High Point, NC 27263, freight prepaid.** Freight class 250.

Specifications and prices are subject to change without prior notice.

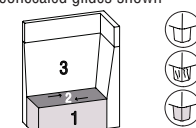

Features	MODEL NUMBER														Approx. Packaged Weight	Delivered Pricing	Moisture Barrier add to list price			
	Basic Model	Non-Cont or Fabric Cont 1	Fab Con 2	Fab Con 3	Pwr Opt	Pwr Type	MT Pwr Loc	IQ Pwr Type	IQ Mod Qty	IQ Pwr Loc	Power Color	Wd Feet Fin	Alum Feet Fin	Moist Barr						
concealed glides shown 	Concealed Glides	MECH60R/CGL/FC	<input type="checkbox"/>	<input type="checkbox"/>	<input type="checkbox"/>	<input type="checkbox"/>	<input type="checkbox"/>	<input type="checkbox"/>	<input type="checkbox"/>	<input type="checkbox"/>	<input type="checkbox"/>	<input type="checkbox"/>	<input type="checkbox"/>	<input type="checkbox"/>	<input type="checkbox"/>			185.00#	\$ 3894	\$ 295
	Poly Feet	MECH60R/PFT/FC	<input type="checkbox"/>	<input type="checkbox"/>	<input type="checkbox"/>	<input type="checkbox"/>	<input type="checkbox"/>	<input type="checkbox"/>	<input type="checkbox"/>	<input type="checkbox"/>	<input type="checkbox"/>	<input type="checkbox"/>	<input type="checkbox"/>	<input type="checkbox"/>	<input type="checkbox"/>			185.00#	3894	295
	Wood Feet	MECH60R/WFT/FC	<input type="checkbox"/>	<input type="checkbox"/>	<input type="checkbox"/>	<input type="checkbox"/>	<input type="checkbox"/>	<input type="checkbox"/>	<input type="checkbox"/>	<input type="checkbox"/>	<input type="checkbox"/>	<input type="checkbox"/>	<input type="checkbox"/>	<input type="checkbox"/>	<input type="checkbox"/>			185.00#	4021	295
	Aluminum Feet	MECH60R/AFT/FC	<input type="checkbox"/>	<input type="checkbox"/>	<input type="checkbox"/>	<input type="checkbox"/>	<input type="checkbox"/>	<input type="checkbox"/>	<input type="checkbox"/>	<input type="checkbox"/>	<input type="checkbox"/>	<input type="checkbox"/>	<input type="checkbox"/>	<input type="checkbox"/>	<input type="checkbox"/>			185.00#	4021	295

MEC60
Extended Corner RIGHT with 60" High-Back - Contrast

- 1 = Base (Contrast 1) C.O.M. = 2 yd
- 2 = Seat (Contrast 2) C.O.M. = .75 yd
- 3 = Back (Contrast 3) C.O.M. = 6 yd
- Gangers included to gang to other 60" High-Back models.
- Ganging to backless units or High-Backback to side ganging (specify kit separately)
- Does not gang with 32" Low-Back units
- Cannot be retrofitted to 48" model
- Power cannot be specified on front of unit on closed-end side. Three available power locations.
- All base models have foot leveling capacity
- Removable seat design, debris clean-out location, and painted wood base to protect against liquids.
- Overall Dimensions:
- W=48" D=26" H=60"
- Seat Dimensions:
- D=18.5" H=18"

HOW TO ORDER

Indicate the following information on order form:
 1. Quantity of each item.
 2. Model number, including options. See "How To Build a Model Number".
 3. Any special service required.

Note: • The indicates that a choice is required.
 • The absence of the indicates that no choice is required.
 • Alpha-numeric characters in place of indicate that no other alternatives are available.

HOW TO BUILD A MODEL NUMBER

- A** Select basic model.
- B** Select non-contrast or fabric contrast 1. Refer to ki.com/fabrics.
• For yardage pricing, see Fabric Yardage Pricing page
- C** Select fabric contrast 2. Refer to ki.com/fabrics.
• For yardage pricing, see Fabric Yardage Pricing page
- D** Select fabric contrast 3. Refer to ki.com/fabrics.
• For yardage pricing, see Fabric Yardage Pricing page
- E** Select power option.

NP	- No power
WP	- With power
- F** Select power type.

DCP	- Byrne Interlink IQ System w/Mini-Tap module OR jumper (Interlink IQ Infeed to power Interlink IQ Systems ordered seperately)
RPT	- Mini-Tap power module w/3-prong plug; add

- G** Select Mini-Tap® module w/3-prong plug location.

LFFP	- Left front facing power
LRFP	- Left rear facing power
RRFP	- Right rear facing power
- H** Select Byrne Interlink®IQ System type.

DCJ	- Byrne Interlink IQ System jumper only; add \$124
DSMOD	- Byrne Interlink IQ System w/Mini-Tap module
- I** Select Byrne Interlink®IQ System w/Mini-Tap® module quantity.

MOD1	- One module; add \$404
MOD2	- Two Modules; add \$807
MOD3	- Three modules; add \$1211
- J** Select Byrne Interlink®IQ System w/Mini-Tap® module location(s).

LFFP	- Left front facing power
LRFP	- Left rear facing power
RRFP	- Right rear facing power
LFLR	- Left front, left rear facing power

- K** Select power module color.

MPB	- Black power module
MPS	- Silver power module
MPW	- White power module
- L** Select wood feet finish. Refer to the **Product Color Options** page in this price list.
- M** Select brushed aluminum feet finish. Refer to the **Product Color Options** page in this price list.
- N** Select moisture barrier.

MB	- Moisture barrier
NMB	- No moisture barrier

 See pricing column for moisture barrier upcharge.

INFORMATION

The removable seat design of MyPlace™ High-Back units allows for ease of installation and clean out, as well as inspection of electrical components. MyPlace™ High-Back offers UL recognized power components and an ETL-Listed power system (Byrne Interlink® IQ). MyPlace™ Lounge is not a UL listed Office Furnishing.

SPECIAL SERVICES

Special Carton Marking
 With specially marked information N/C

Shipping
 Ships **partially assembled, FOB High Point, NC 27263, freight prepaid.** Freight class 250.

Specifications and prices are subject to change without prior notice.

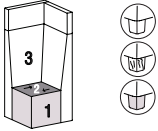

Features	MODEL NUMBER								Approx. Packaged Weight	Delivered Pricing	Moisture Barrier add to list price
	Basic Model	Non-Contrast or Fabric Contrast 1	Fabric Contrast 2	Fabric Contrast 3	Power Option	Wood Feet Finish	Alum-inum Feet Finish	Moisture Barrier			
concealed glides shown 	Concealed Glides	MCNH60L/CGL/FC	<input type="checkbox"/>	<input type="checkbox"/>	<input type="checkbox"/>	<input type="checkbox"/>		<input type="checkbox"/>	130.00#	\$ 3006	\$ 266
	Poly Feet	MCNH60L/PFT/FC	<input type="checkbox"/>	<input type="checkbox"/>	<input type="checkbox"/>	<input type="checkbox"/>		<input type="checkbox"/>	130.00#	3006	266
	Wood Feet	MCNH60L/WFT/FC	<input type="checkbox"/>	<input type="checkbox"/>	<input type="checkbox"/>	<input type="checkbox"/>	<input type="checkbox"/>	<input type="checkbox"/>	130.00#	3135	266
	Aluminum Feet	MCNH60L/AFT/FC	<input type="checkbox"/>	<input type="checkbox"/>	<input type="checkbox"/>	<input type="checkbox"/>		<input type="checkbox"/>	130.00#	3135	266
MCN60											
Corner LEFT with 60" High-Back - Contrast											
<ul style="list-style-type: none"> • 1 = Base (Contrast 1) C.O.M. = 1.5 yd • 2 = Seat (Contrast 2) C.O.M. = .75 yd • 3 = Back (Contrast 3) C.O.M. = 4.75 yd • Gangers included to gang to other 60" High-Back models. • Ganging to backless units or High-Back back to side ganging (specify kit separately) • Does not gang with 32" Low-Back units • Cannot be retrofitted to 48" model • No Mini-Tap® Power options • Byrne Interlink®IQ power only available as a pass-through jumper • All base models have foot leveling capacity • Removable seat design, debris clean-out location, and painted wood base to protect against liquids. • Overall Dimensions: • W=26" D=26" H=60" Seat Dimensions: • D=18.5" H=18" 											
			A	B	C	D	E	F	G	H	

HOW TO ORDER

Indicate the following information on order form:
 1. Quantity of each item.
 2. Model number, including options. See "How To Build a Model Number".
 3. Any special service required.

Note: • The indicates that a choice is required.
 • The absence of the indicates that no choice is required.
 • Alpha-numeric characters in place of indicate that no other alternatives are available.

HOW TO BUILD A MODEL NUMBER

- A** Select basic model.
- B** Select non-contrast or fabric contrast 1. Refer to ki.com/fabrics.
 - For yardage pricing, see Fabric Yardage Pricing page
- C** Select fabric contrast 2. Refer to ki.com/fabrics
 - For yardage pricing, see Fabric Yardage Pricing page
- D** Select fabric contrast 3. Refer to ki.com/fabrics
 - For yardage pricing, see Fabric Yardage Pricing page
- E** Select power option.
 - DCJ** - Byrne Interlink IQ System jumper only; add \$124
 - NP** - No power
- F** Select wood feet finish.

Refer to the **Product Color Options** page in this price list.

- G** Select brushed aluminum feet finish. Refer to the **Product Color Options** page in this price list.
- H** Select moisture barrier.
 - MB** - Moisture barrier
 - NMB** - No moisture barrier
 See pricing column for moisture barrier upcharge.

INFORMATION

The removable seat design of MyPlace™ High-Back units allows for ease of installation and clean out, as well as inspection of electrical components. MyPlace™ High-Back offers UL recognized power components and an ETL-Listed power system (Byrne Interlink® IQ). MyPlace™ Lounge is not a UL listed Office Furnishing.

SPECIAL SERVICES

Special Carton Marking

With specially marked information N/C

Shipping
 Ships **partially assembled, FOB High Point, NC 27263, freight prepaid.** Freight class 250.

Specifications and prices are subject to change without prior notice.

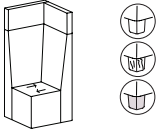

Features	MODEL NUMBER						Approx. Packaged Weight	Delivered Pricing	Moisture Barrier add to list price	
	Basic Model	Non-Contrast or Fabric Contrast 1	Power Option	Wood Feet Finish	Aluminum Feet Finish	Moisture Barrier				
concealed glides shown 	Concealed Glides	MCNH60R/CGL/NC	<input type="checkbox"/> <input type="checkbox"/> <input type="checkbox"/>	<input type="checkbox"/> <input type="checkbox"/> <input type="checkbox"/>			<input type="checkbox"/> <input type="checkbox"/> <input type="checkbox"/>	130.00#	\$ 2954	\$ 266
	Poly Feet, Non-contrast	MCNH60R/PFT/NC	<input type="checkbox"/> <input type="checkbox"/> <input type="checkbox"/>	<input type="checkbox"/> <input type="checkbox"/> <input type="checkbox"/>			<input type="checkbox"/> <input type="checkbox"/> <input type="checkbox"/>	130.00#	2954	266
	Wood Feet, Non-contrast	MCNH60R/WFT/NC	<input type="checkbox"/> <input type="checkbox"/> <input type="checkbox"/>	<input type="checkbox"/> <input type="checkbox"/> <input type="checkbox"/>	<input type="checkbox"/> <input type="checkbox"/>		<input type="checkbox"/> <input type="checkbox"/> <input type="checkbox"/>	130.00#	3080	266
	Aluminum Feet, Non-contrast	MCNH60R/AFT/NC	<input type="checkbox"/> <input type="checkbox"/> <input type="checkbox"/>	<input type="checkbox"/> <input type="checkbox"/> <input type="checkbox"/>		<input type="checkbox"/> <input type="checkbox"/>	<input type="checkbox"/> <input type="checkbox"/> <input type="checkbox"/>	130.00#	3080	266
<p>MCN60</p> <p>Corner RIGHT with 60" High-Back - Non-contrast</p> <ul style="list-style-type: none"> • Non-contrast C.O.M = 5.75 yds • Gangers included to gang to other 60" High-Back models. • Ganging to backless units or High-Backk back to side ganging (specify kit separately) • Does not gang with 32" Low-Back units • Cannot be retrofitted to 48" model • No Mini-Tap® Power options • Byrne Interlink®IQ power only available as a pass-through jumper • All base models have foot leveling capacity • Removable seat design, debris clean-out location, and painted wood base to protect against liquids. • Overall Dimensions: W=26" D=26" H=60" • Seat Dimensions: D=18.5" H=18" 										
			A	B	C	D	E	F		

HOW TO ORDER

- Indicate the following information on order form:
1. Quantity of each item.
 2. Model number, including options. See "How To Build a Model Number".
 3. Any special service required.

- Note:
- The indicates that a choice is required.
 - The absence of the indicates that no choice is required.
 - Alpha-numeric characters in place of indicate that no other alternatives are available.

HOW TO BUILD A MODEL NUMBER

See pricing column for moisture barrier upcharge.

- A** Select basic model.
- B** Select non-contrast or fabric contrast 1. Refer to ki.com/fabrics.
 - For yardage pricing, see Fabric Yardage Pricing page
- C** Select power option.
 - DCJ** - Byrne Interlink IQ System jumper only; add \$124
 - NP** - No power
- D** Select wood feet finish. Refer to the **Product Color Options** page in this price list.
- E** Select brushed aluminum feet finish. Refer to the **Product Color Options** page in this price list.
- F** Select moisture barrier.
 - MB** - Moisture barrier
 - NMB** - No moisture barrier

INFORMATION

The removable seat design of MyPlace™ High-Back units allows for ease of installation and clean out, as well as inspection of electrical components. MyPlace™ High-Back offers UL recognized power components and an ETL-Listed power system (Byrne Interlink® IQ). MyPlace™ Lounge is not a UL listed Office Furnishing.

SPECIAL SERVICES

Special Carton Marking

With specially marked information N/C

Shipping

Ships **partially assembled, FOB High Point, NC 27263, freight prepaid.** Freight class 250.

Specifications and prices are subject to change without prior notice.

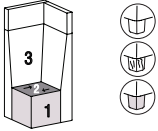

Features	MODEL NUMBER								Approx. Packaged Weight	Delivered Pricing	Moisture Barrier add to list price	
	Basic Model	Non-Contrast or Fabric Contrast 1	Fabric Contrast 2	Fabric Contrast 3	Power Option	Wood Feet Finish	Aluminum Feet Finish	Moisture Barrier				
concealed glides shown 	Concealed Glides	MCNH60R/CGL/FC	<input type="checkbox"/>	<input type="checkbox"/>	<input type="checkbox"/>	<input type="checkbox"/>		<input type="checkbox"/>	130.00#	\$ 3006	\$ 266	
	Poly Feet	MCNH60R/PFT/FC	<input type="checkbox"/>	<input type="checkbox"/>	<input type="checkbox"/>	<input type="checkbox"/>		<input type="checkbox"/>	130.00#	3006	266	
	Wood Feet	MCNH60R/WFT/FC	<input type="checkbox"/>	<input type="checkbox"/>	<input type="checkbox"/>	<input type="checkbox"/>	<input type="checkbox"/>	<input type="checkbox"/>	130.00#	3135	266	
	Aluminum Feet	MCNH60R/AFT/FC	<input type="checkbox"/>	<input type="checkbox"/>	<input type="checkbox"/>	<input type="checkbox"/>		<input type="checkbox"/>	130.00#	3135	266	
MCN60 Corner RIGHT with 60" High-Back Contrast												
<ul style="list-style-type: none"> 1 = Base (Contrast 1) C.O.M. = 1.5 yd 2 = Seat (Contrast 2) C.O.M. = .75 yd 3 = Back (Contrast 3) C.O.M. = 4.75 yd Gangers included to gang to other 60" High-Back models. Ganging to backless units or High-Back back to side ganging (specify kit separately) Does not gang with 32" Low-Back units Cannot be retrofitted to 48" model No Mini-Tap® Power options Byrne Interlink®IQ power only available as a pass-through jumper All base models have foot leveling capacity Removable seat design, debris clean-out location, and painted wood base to protect against liquids. Overall Dimensions: <ul style="list-style-type: none"> W=26" D=26" H=60" Seat Dimensions: <ul style="list-style-type: none"> D=18.5" H=18" 												
			A	B	C	D	E	F	G			H

HOW TO ORDER

Indicate the following information on order form:
 1. Quantity of each item.
 2. Model number, including options. See "How To Build a Model Number".
 3. Any special service required.

Note: • The indicates that a choice is required.
 • The absence of the indicates that no choice is required.
 • Alpha-numeric characters in place of indicate that no other alternatives are available.

HOW TO BUILD A MODEL NUMBER

- A** Select basic model.
- B** Select non-contrast or fabric contrast 1. Refer to ki.com/fabrics.
 - For yardage pricing, see Fabric Yardage Pricing page
- C** Select fabric contrast 2. Refer to ki.com/fabrics
 - For yardage pricing, see Fabric Yardage Pricing page
- D** Select fabric contrast 3. Refer to ki.com/fabrics
 - For yardage pricing, see Fabric Yardage Pricing page
- E** Select power option.
 - DCJ** - Byrne Interlink IQ System jumper only; add \$124
 - NP** - No power
- F** Select wood feet finish.

Refer to the **Product Color Options** page in this price list.

- G** Select brushed aluminum feet finish. Refer to the **Product Color Options** page in this price list.
- H** Select moisture barrier.
 - MB** - Moisture barrier
 - NMB** - No moisture barrier
 See pricing column for moisture barrier upcharge.

INFORMATION

The removable seat design of MyPlace™ High-Back units allows for ease of installation and clean out, as well as inspection of electrical components. MyPlace™ High-Back offers UL recognized power components and an ETL-Listed power system (Byrne Interlink® IQ). MyPlace™ Lounge is not a UL listed Office Furnishing.

SPECIAL SERVICES

Special Carton Marking

With specially marked information N/C

Shipping
 Ships **partially assembled, FOB High Point, NC 27263, freight prepaid.** Freight class 250.

Specifications and prices are subject to change without prior notice.

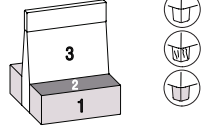

Features	MODEL NUMBER													Approx. Packaged Weight	Delivered Pricing	Moisture Barrier add to list price				
	Basic Model	Non-Cont or Fabric Cont 1	Fab Con 2	Fab Con 3	Pwr Opt	Pwr Type	MT Pwr Loc	IQ Pwr Type	IQ Mod Qty	IQ Pwr Loc	Power Color	Wood Feet Finish	Alum-inum Feet Finish				Moist Barr			
concealed glides shown 	Concealed Glides	MBH60/CGL/FC	<input type="checkbox"/>	<input type="checkbox"/>	<input type="checkbox"/>	<input type="checkbox"/>	<input type="checkbox"/>	<input type="checkbox"/>										300.00#	\$ 4563	\$ 305
	Poly Feet	MBH60/PFT/FC	<input type="checkbox"/>	<input type="checkbox"/>	<input type="checkbox"/>	<input type="checkbox"/>	<input type="checkbox"/>	<input type="checkbox"/>										300.00#	4563	305
	Wood Feet	MBH60/WFT/FC	<input type="checkbox"/>	<input type="checkbox"/>	<input type="checkbox"/>	<input type="checkbox"/>	<input type="checkbox"/>	<input type="checkbox"/>				<input type="checkbox"/>						300.00#	4691	305
	Aluminum Feet	MBH60/AFT/FC	<input type="checkbox"/>	<input type="checkbox"/>	<input type="checkbox"/>	<input type="checkbox"/>	<input type="checkbox"/>	<input type="checkbox"/>					<input type="checkbox"/>					300.00#	4691	305
<p>MB60</p> <p>Booth, Two-Sided, 60" High-Back-Contrast</p> <ul style="list-style-type: none"> • 1 = Base (Contrast 1) C.O.M. = 3.5 yd • 2 = Seat (Contrast 2) C.O.M. = 1.5 yd • 3 = Back (Contrast 3) C.O.M. = 4.5 yd • Gangers included to gang to other 60" High-Backmodels. • Ganging to backless units or High-Back back to side ganging (specify kit separately) • Does not gang with 32" Low-Back units • Cannot be retrofitted to 48" model • All base models have foot leveling capacity • Removable seat design, debris clean-out location, and painted wood base to protect against liquids. • Overall Dimensions: • W=48" D=52" H=60" Seat Dimensions: • D=19.375" H=18" 																				
<p>A B C D E F G H I J K L M N</p>																				

HOW TO ORDER

- Indicate the following information on order form:
- Quantity of each item.
 - Model number, including options. See "How To Build a Model Number".
 - Any special service required.

Note: • The indicates that a choice is required.
 • The absence of the indicates that no choice is required.
 • Alpha-numeric characters in place of indicate that no other alternatives are available.

HOW TO BUILD A MODEL NUMBER

- A** Select basic model.
- B** Select non-contrast or fabric contrast 1. Refer to ki.com/fabrics.
 • For yardage pricing, see Fabric Yardage Pricing page
- C** Select fabric contrast 2. Refer to ki.com/fabrics.
 • For yardage pricing, see Fabric Yardage Pricing page
- D** Select fabric contrast 3. Refer to ki.com/fabrics.
 • For yardage pricing, see Fabric Yardage Pricing page
- E** Select power option.
 NP - No power
 WP - With power
- F** Select power type.
 DCP - Byrne Interlink IQ System w/Mini-Tap module OR jumper (Interlink IQ Infeed to power Interlink IQ Systems ordered seperately)
 RPT - Mini-Tap power module w/3-prong plug; add \$314

- G** Select Mini-Tap® module w/3-prong plug location.
 LFFP - Left front facing power
 LRFP - Left rear facing power
 RFFP - Right front facing power
 RRFP - Right rear facing power
- H** Select Byrne Interlink®IQ System type.
 DCJ - Byrne Interlink IQ System jumper only; add \$124
 DSMOD - Byrne Interlink IQ System w/Mini-Tap module
- I** Select Byrne Interlink®IQ System w/Mini-Tap® module quantity.
 MOD1 - One module; add \$404
 MOD2 - Two Modules; add \$807
 MOD3 - Three modules; add \$1211
 MOD4 - Four modules; add \$1614
- J** Select Byrne Interlink®IQ System w/Mini-Tap® module location(s).
 LFFP - Left front facing power
 LRFP - Left rear facing power
 RFFP - Right front facing power
 RRFP - Right rear facing power
 LFLR - Left front, left rear facing power
 LFRF - Left front, right front facing power
 LFRR - Left front, right rear facing power

- K** Select power module color.
 MPB - Black power module
 MPS - Silver power module
 MPW - White power module
- L** Select wood feet finish. Refer to the **Product Color Options** page in this price list.
- M** Select brushed aluminum feet finish. Refer to the **Product Color Options** page in this price list.
- N** Select moisture barrier.
 MB - Moisture barrier
 NMB - No moisture barrier
 See pricing column for moisture barrier upcharge.

INFORMATION

The removable seat design of MyPlace™ High-Back units allows for ease of installation and clean out, as well as inspection of electrical components. MyPlace™ High-Back offers UL recognized power components and an ETL-Listed power system (Byrne Interlink® IQ). MyPlace™ Lounge is not a UL listed Office Furnishing.

SPECIAL SERVICES

Special Carton Marking

With specially marked information N/C

Shipping
 Ships **partially assembled, FOB High Point, NC 27263, freight prepaid.** Freight class 250.

Specifications and prices are subject to change without prior notice.



Features	MODEL NUMBER													Approx. Packaged Weight	Delivered Pricing	Moisture Barrier add to list price		
	Basic Model	Non-Cont or Fabric Cont 1	Pwr Opt	Pwr Type	MT Pwr Loc	IQ Pwr Type	IQ Mod Qty	IQ Pwr Loc	Power Color	Wd Feet Fin	Alum Feet Fin	Moist Barr						
concealed glides shown	Concealed Glides	MCIH46/CGL/NC	<input type="checkbox"/>	<input type="checkbox"/>	<input type="checkbox"/>	<input type="checkbox"/>	<input type="checkbox"/>	<input type="checkbox"/>	<input type="checkbox"/>	<input type="checkbox"/>	<input type="checkbox"/>	<input type="checkbox"/>	<input type="checkbox"/>	<input type="checkbox"/>				\$ 261
	Poly Feet	MCIH46/PFT/NC	<input type="checkbox"/>	<input type="checkbox"/>	<input type="checkbox"/>	<input type="checkbox"/>	<input type="checkbox"/>	<input type="checkbox"/>	<input type="checkbox"/>	<input type="checkbox"/>	<input type="checkbox"/>	<input type="checkbox"/>	<input type="checkbox"/>	<input type="checkbox"/>				261
	Wood Feet	MCIH46/WFT/NC	<input type="checkbox"/>	<input type="checkbox"/>	<input type="checkbox"/>	<input type="checkbox"/>	<input type="checkbox"/>	<input type="checkbox"/>	<input type="checkbox"/>	<input type="checkbox"/>	<input type="checkbox"/>	<input type="checkbox"/>	<input type="checkbox"/>	<input type="checkbox"/>				261
	Aluminum Feet	MCIH46/AFT/NC	<input type="checkbox"/>	<input type="checkbox"/>	<input type="checkbox"/>	<input type="checkbox"/>	<input type="checkbox"/>	<input type="checkbox"/>	<input type="checkbox"/>	<input type="checkbox"/>	<input type="checkbox"/>	<input type="checkbox"/>	<input type="checkbox"/>	<input type="checkbox"/>				261
MCI46																		
Inside Back, 45° Curve, 60" High-Back - Non-contrast																		
<ul style="list-style-type: none"> • Non-contrast C.O.M = 5.5 yds • Gangers included to gang to other 60" High-Back models. • Ganging to backless units or High-Back back to side ganging (specify kit separately) • Does not gang with 32" Low-Back units • Cannot be retrofitted to 48" model • All base models have foot leveling capacity • Removable seat design, debris clean-out location, and painted wood base to protect against liquids. 																		
Overall Dimensions:																		
• W=41.5" D=26" H=60"																		
Seat Dimensions:																		
• D=18.5" H=18"																		
A B C D E F G H I J K L																		

HOW TO ORDER

- Indicate the following information on order form:
1. Quantity of each item.
 2. Model number, including options. See "How To Build a Model Number".
 3. Any special service required.

Note: • The indicates that a choice is required.
 • The absence of the indicates that no choice is required.
 • Alpha-numeric characters in place of indicate that no other alternatives are available.

HOW TO BUILD A MODEL NUMBER

- A** Select basic model.
- B** Select non-contrast or fabric contrast 1. Refer to ki.com/fabrics.
 • For yardage pricing, see Fabric Yardage Pricing page
- C** Select power option.
NP - No power
WP - With power
- D** Select power type.
DCP - Byrne Interlink IQ System w/Mini-Tap module OR jumper (Interlink IQ Infeed to power Interlink IQ Systems ordered separately)
RPT - Mini-Tap power module w/3-prong plug; add \$314
- E** Select Mini-Tap® module w/3-prong plug location.
LFFP - Left front facing power
LRFP - Left rear facing power
RFFP - Right front facing power
RRFP - Right rear facing power

- F** Select Byrne Interlink®IQ System type.
DCJ - Byrne Interlink IQ System jumper only; add \$124
DSMOD - Byrne Interlink IQ System w/Mini-Tap module
- G** Select Byrne Interlink®IQ System w/Mini-Tap® module quantity.
MOD1 - One module; add \$404
MOD2 - Two Modules; add \$807
MOD3 - Three modules; add \$1211
MOD4 - Four modules; add \$1614
- H** Select Byrne Interlink®IQ System w/Mini-Tap® module location(s).
LFFP - Left front facing power
LRFP - Left rear facing power
RFFP - Right front facing power
RRFP - Right rear facing power
LFLR - Left front, left rear facing power
LFRF - Left front, right front facing power
LFRR - Left front, right rear facing power
LRRF - Left rear, right front facing power
LRRR - Left rear, right rear facing power
RRRF - Right rear, right front facing power

- I** Select power module color.
MPB - Black power module
MPS - Silver power module
MPW - White power module
- J** Select wood feet finish. Refer to the **Product Color Options** page in this price list.
- K** Select brushed aluminum feet finish. Refer to the **Product Color Options** page in this price list.
- L** Select moisture barrier.
MB - Moisture barrier
NMB - No moisture barrier
 See pricing column for moisture barrier upcharge.

INFORMATION

The removable seat design of MyPlace™ High-Back units allows for ease of installation and clean out, as well as inspection of electrical components. MyPlace™ High-Back offers UL recognized power components and an ETL-Listed power system (Byrne Interlink® IQ). MyPlace™ Lounge is not a UL listed Office Furnishing.

SPECIAL SERVICES

Special Carton Marking

With specially marked information N/C

Shipping
 Ships **partially assembled, FOB High Point, NC 27263, freight prepaid.** Freight class 250.

Specifications and prices are subject to change without prior notice.



Features	Basic Model	MODEL NUMBER														Approx. Packaged Weight	Delivered Pricing	Moisture Barrier add to list price		
		Non-Cont or Fabric Cont 1	Fab Con 2	Fab Con 3	Pwr Opt	Pwr Type	MT Pwr Loc	IQ Pwr Type	IQ Mod Qty	IQ Pwr Loc	Power Color	Wd Feet Fin	Alum Feet Fin	Moist Barr						
concealed glides shown	Concealed Glides	MCIH46/CGL/FC	<input type="checkbox"/>	<input type="checkbox"/>	<input type="checkbox"/>	<input type="checkbox"/>	<input type="checkbox"/>	<input type="checkbox"/>	<input type="checkbox"/>	<input type="checkbox"/>	<input type="checkbox"/>	<input type="checkbox"/>	<input type="checkbox"/>	<input type="checkbox"/>	<input type="checkbox"/>	<input type="checkbox"/>	<input type="checkbox"/>	150.00#	\$ 2844	\$ 261
	Poly Feet	MCIH46/PFT/FC	<input type="checkbox"/>	<input type="checkbox"/>	<input type="checkbox"/>	<input type="checkbox"/>	<input type="checkbox"/>	<input type="checkbox"/>	<input type="checkbox"/>	<input type="checkbox"/>	<input type="checkbox"/>	<input type="checkbox"/>	<input type="checkbox"/>	<input type="checkbox"/>	<input type="checkbox"/>	<input type="checkbox"/>	<input type="checkbox"/>	150.00#	2844	261
	Wood Feet	MCIH46/WFT/FC	<input type="checkbox"/>	<input type="checkbox"/>	<input type="checkbox"/>	<input type="checkbox"/>	<input type="checkbox"/>	<input type="checkbox"/>	<input type="checkbox"/>	<input type="checkbox"/>	<input type="checkbox"/>	<input type="checkbox"/>	<input type="checkbox"/>	<input type="checkbox"/>	<input type="checkbox"/>	<input type="checkbox"/>	<input type="checkbox"/>	150.00#	2972	261
	Aluminum Feet	MCIH46/AFT/FC	<input type="checkbox"/>	<input type="checkbox"/>	<input type="checkbox"/>	<input type="checkbox"/>	<input type="checkbox"/>	<input type="checkbox"/>	<input type="checkbox"/>	<input type="checkbox"/>	<input type="checkbox"/>	<input type="checkbox"/>	<input type="checkbox"/>	<input type="checkbox"/>	<input type="checkbox"/>	<input type="checkbox"/>	<input type="checkbox"/>	150.00#	2972	261

MCI46
Inside Back, 45° Curve, 60" High-Back - Contrast

- 1 = Base (Contrast 1) C.O.M. = 1.25 yd
- 2 = Seat (Contrast 2) C.O.M. = .75 yd
- 3 = Back (Contrast 3) C.O.M. = 4 yd
- Gangers included to gang to other 60" High-Back models.
- Ganging to backless units or High-Back back to side ganging (specify kit separately)
- Does not gang with 32" Low-Back units
- Cannot be retrofitted to 48" model
- All base models have foot leveling capacity
- Removable seat design, debris clean-out location, and painted wood base to protect against liquids.

Overall Dimensions:
 • W=41.5" D=26" H=60"
 Seat Dimensions:
 • D=18.5" H=18"

HOW TO ORDER

Indicate the following information on order form:

- Quantity of each item.
- Model number, including options. See "How To Build a Model Number".
- Any special service required.

Note:

- The indicates that a choice is required.
- The absence of the indicates that no choice is required.
- Alpha-numeric characters in place of indicate that no other alternatives are available.

HOW TO BUILD A MODEL NUMBER

A Select basic model.

B Select non-contrast or fabric contrast 1. Refer to ki.com/fabrics.
 • For yardage pricing, see Fabric Yardage Pricing page

C Select fabric contrast 2. Refer to ki.com/fabrics.
 • For yardage pricing, see Fabric Yardage Pricing page

D Select fabric contrast 3. Refer to ki.com/fabrics.
 • For yardage pricing, see Fabric Yardage Pricing page

E Select power option.
NP - No power
WP - With power

F Select power type.
DCP - Byrne Interlink IQ System w/Mini-Tap module OR jumper (Interlink IQ Infeed to power Interlink IQ Systems ordered seperately)
RPT - Mini-Tap power module w/3-prong plug; add \$314

G Select Byrne Mini-Tap® module w/3-prong plug location.
LFFP - Left front facing power
LRFP - Left rear facing power
RFFP - Right front facing power
RRFP - Right rear facing power

H Select Byrne Interlink®IQ System type.
DCJ - Byrne Interlink IQ System jumper only; add \$124
DSMOD - Byrne Interlink IQ System w/Mini-Tap module

I Select Byrne Interlink®IQ System w/Mini-Tap® module quantity.
MOD1 - One module; add \$404
MOD2 - Two Modules; add \$807
MOD3 - Three modules; add \$1211
MOD4 - Four modules; add \$1614

J Select Byrne Interlink®IQ System w/Mini-Tap® module location(s).
LFFP - Left front facing power
LRFP - Left rear facing power
RFFP - Right front facing power
RRFP - Right rear facing power
LFLR - Left front, left rear facing power

K Select power module color.
MPB - Black power module
MPS - Silver power module
MPW - White power module

L Select wood feet finish. Refer to the **Product Color Options** page in this price list.

M Select brushed aluminum feet finish. Refer to the **Product Color Options** page in this price list.

N Select moisture barrier.
MB - Moisture barrier
NMB - No moisture barrier

See pricing column for moisture barrier upcharge.

INFORMATION

The removable seat design of MyPlace™ High-Back units allows for ease of installation and clean out, as well as inspection of electrical components. MyPlace™ High-Back offers UL recognized power components and an ETL-Listed power system (Byrne Interlink® IQ). MyPlace™ Lounge is not a UL listed Office Furnishing.

SPECIAL SERVICES

Special Carton Marking
 With specially marked information N/C

Shipping
 Ships **partially assembled, FOB High Point, NC 27263, freight prepaid.** Freight class 250.

Specifications and prices are subject to change without prior notice.



Features	MODEL NUMBER													Approx. Packaged Weight	Delivered Pricing	Moisture Barrier add to list price			
	Basic Model	Non-Cont or Fabric Cont 1	Pwr Opt	Pwr Type	MT Pwr Loc	IQ Pwr Type	IQ Mod Qty	IQ Pwr Loc	Power Color	Wd Feet Fin	Alum Feet Fin	Moist Barr							
concealed glides shown	Concealed Glides	MCOH46/CGL/NC	<input type="checkbox"/>	<input type="checkbox"/>	<input type="checkbox"/>	<input type="checkbox"/>	<input type="checkbox"/>	<input type="checkbox"/>	<input type="checkbox"/>	<input type="checkbox"/>	<input type="checkbox"/>	<input type="checkbox"/>	<input type="checkbox"/>				145.00#	\$ 2772	\$ 244
	Poly Feet	MCOH46/PFT/NC	<input type="checkbox"/>	<input type="checkbox"/>	<input type="checkbox"/>	<input type="checkbox"/>	<input type="checkbox"/>	<input type="checkbox"/>	<input type="checkbox"/>	<input type="checkbox"/>	<input type="checkbox"/>	<input type="checkbox"/>	<input type="checkbox"/>				145.00#	2772	244
	Wood Feet	MCOH46/WFT/NC	<input type="checkbox"/>	<input type="checkbox"/>	<input type="checkbox"/>	<input type="checkbox"/>	<input type="checkbox"/>	<input type="checkbox"/>	<input type="checkbox"/>	<input type="checkbox"/>	<input type="checkbox"/>	<input type="checkbox"/>	<input type="checkbox"/>				145.00#	2897	244
	Aluminum Feet	MCOH46/AFT/NC	<input type="checkbox"/>	<input type="checkbox"/>	<input type="checkbox"/>	<input type="checkbox"/>	<input type="checkbox"/>	<input type="checkbox"/>	<input type="checkbox"/>	<input type="checkbox"/>	<input type="checkbox"/>	<input type="checkbox"/>	<input type="checkbox"/>				145.00#	2897	244

MCO46
Outside Back, 45° Curve, 60" High-Back - Non-contrast
 • Non-contrast C.O.M = 4.5 yds
 • Gangers included to gang to other 60" High-Back models.
 • Ganging to backless units or High-Back back to side ganging (specify kit separately)
 • Does not gang with 32" Low-Back units
 • Cannot be retrofitted to 48" model
 • All base models have foot leveling capacity
 • Removable seat design, debris clean-out location, and painted wood base to protect against liquids.
 Overall Dimensions:
 • W=41.5" D=26" H=60"
 Seat Dimensions:
 • D=18.5" H=18"

A B C D E F G H I J K L

HOW TO ORDER

Indicate the following information on order form:
 1. Quantity of each item.
 2. Model number, including options. See "How To Build a Model Number".
 3. Any special service required.

Note: • The indicates that a choice is required.
 • The absence of the indicates that no choice is required.
 • Alpha-numeric characters in place of indicate that no other alternatives are available.

HOW TO BUILD A MODEL NUMBER

- A** Select basic model.
- B** Select non-contrast or fabric contrast 1. Refer to ki.com/fabrics.
 • For yardage pricing, see Fabric Yardage Pricing page
- C** Select power option.
 NP - No power
 WP - With power
- D** Select power type.
 DCP - Byrne Interlink IQ System w/Mini-Tap module OR jumper (Interlink IQ Infeed to power Interlink IQ Systems ordered seperately)
 RPT - Mini-Tap power module w/3-prong plug; add \$314
- E** Select Mini-Tap® module w/3-prong plug location.
 LFFP - Left front facing power
 LRFP - Left rear facing power
 RFFP - Right front facing power
 RRFPP - Right rear facing power
- F** Select Byrne Interlink®IQ System type.

- DCJ - Byrne Interlink IQ System jumper only; add \$124
- DSMOD - Byrne Interlink IQ System w/Mini-Tap module
- G** Select Byrne Interlink®IQ System w/Mini-Tap® module quantity.
 MOD1 - One module; add \$404
 MOD2 - Two Modules; add \$807
 MOD3 - Three modules; add \$1211
 MOD4 - Four modules; add \$1614
- H** Select Byrne Interlink®IQ System w/Mini-Tap® module location(s).
 LFFP - Left front facing power
 LRFP - Left rear facing power
 RFFP - Right front facing power
 RRFPP - Right rear facing power
 LFLR - Left front, left rear facing power
 LFRF - Left front, right front facing power
 LFRR - Left front, right rear facing power
 LRRF - Left rear, right front facing power
 LRRR - Left rear, right rear facing power
 RRRF - Right rear, right front facing power
 RFLRRR - Left front, left rear, right rear facing power
 LFRFLR - Left front, right front, left rear facing power
 LFRFRR - Left front, right front, right rear facing power

- RFLRRR - Right front, left rear, right rear facing power
- LFRFLRRR - Left front, right front, left rear, right rear facing power
- I** Select power module color.
 MPB - Black power module
 MPS - Silver power module
 MPW - White power module
- J** Select wood feet finish.
 Refer to the **Product Color Options** page in this price list.
- K** Select brushed aluminum feet finish.
 Refer to the **Product Color Options** page in this price list.
- L** Select moisture barrier.
 MB - Moisture barrier
 NMB - No moisture barrier
 See pricing column for moisture barrier upcharge.

INFORMATION

The removable seat design of MyPlace™ High-Back units allows for ease of installation and clean out, as well as inspection of electrical components. MyPlace™ High-Back offers UL recognized power components and an ETL-Listed power system (Byrne Interlink® IQ). MyPlace™ Lounge is not a UL listed Office Furnishing.

SPECIAL SERVICES

Special Carton Marking

With specially marked information N/C

Shipping
 Ships **partially assembled, FOB High Point, NC 27263, freight prepaid.** Freight class 250.

Specifications and prices are subject to change without prior notice.

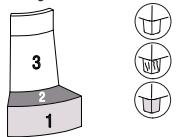

Features	MODEL NUMBER														Approx. Packaged Weight	Delivered Pricing	Moisture Barrier add to list price		
	Basic Model	Non-Cont or Fabric Cont 1	Fab Con 2	Fab Con 3	Pwr Opt	Pwr Type	MT Pwr Loc	IQ Pwr Type	IQ Mod Qty	IQ Pwr Loc	Power Color	Wd Feet Fin	Alum Feet Fin	Moist Barr					
concealed glides shown 	Concealed Glides	MCOH46/CGL/FC	<input type="checkbox"/>	<input type="checkbox"/>	<input type="checkbox"/>	<input type="checkbox"/>	<input type="checkbox"/>	<input type="checkbox"/>	<input type="checkbox"/>	<input type="checkbox"/>	<input type="checkbox"/>	<input type="checkbox"/>	<input type="checkbox"/>	<input type="checkbox"/>	<input type="checkbox"/>	<input type="checkbox"/>	145.00#	\$ 2821	\$ 244
	Poly Feet	MCOH46/PFT/FC	<input type="checkbox"/>	<input type="checkbox"/>	<input type="checkbox"/>	<input type="checkbox"/>	<input type="checkbox"/>	<input type="checkbox"/>	<input type="checkbox"/>	<input type="checkbox"/>	<input type="checkbox"/>	<input type="checkbox"/>	<input type="checkbox"/>	<input type="checkbox"/>	<input type="checkbox"/>	<input type="checkbox"/>	145.00#	2821	244
	Wood Feet	MCOH46/WFT/FC	<input type="checkbox"/>	<input type="checkbox"/>	<input type="checkbox"/>	<input type="checkbox"/>	<input type="checkbox"/>	<input type="checkbox"/>	<input type="checkbox"/>	<input type="checkbox"/>	<input type="checkbox"/>	<input type="checkbox"/>	<input type="checkbox"/>	<input type="checkbox"/>	<input type="checkbox"/>	<input type="checkbox"/>	145.00#	2950	244
	Aluminum Feet	MCOH46/AFT/FC	<input type="checkbox"/>	<input type="checkbox"/>	<input type="checkbox"/>	<input type="checkbox"/>	<input type="checkbox"/>	<input type="checkbox"/>	<input type="checkbox"/>	<input type="checkbox"/>	<input type="checkbox"/>	<input type="checkbox"/>	<input type="checkbox"/>	<input type="checkbox"/>	<input type="checkbox"/>	<input type="checkbox"/>	145.00#	2950	244
MCO46																			
Outside Back, 45° Curve, 60" High-Back - Contrast																			
<ul style="list-style-type: none"> • 1 = Base (Contrast 1) C.O.M. = 2 yd • 2 = Seat (Contrast 2) C.O.M. = .75 yd • 3 = Back (Contrast 3) C.O.M. = 2.75 yd • Gangers included to gang to other 60" High-Back models. • Ganging to backless units or High-Back back to side ganging (specify kit separately) • Does not gang with 32" Low-Back units • Cannot be retrofitted to 48" model • All base models have foot leveling capacity • Removable seat design, debris clean-out location, and painted wood base to protect against liquids. 																			
Overall Dimensions:																			
• W=41.5" D=26" H=60"																			
Seat Dimensions:																			
• D=18.5" H=18"																			
A B C D E F G H I J K L M N																			

HOW TO ORDER

- Indicate the following information on order form:
1. Quantity of each item.
 2. Model number, including options. See "How To Build a Model Number".
 3. Any special service required.

Note: • The indicates that a choice is required.
 • The absence of the indicates that no choice is required.
 • Alpha-numeric characters in place of indicate that no other alternatives are available.

HOW TO BUILD A MODEL NUMBER

- A** Select basic model.
- B** Select non-contrast or fabric contrast 1. Refer to ki.com/fabrics.
• For yardage pricing, see Fabric Yardage Pricing page
- C** Select fabric contrast 2. Refer to ki.com/fabrics.
• For yardage pricing, see Fabric Yardage Pricing page
- D** Select fabric contrast 3. Refer to ki.com/fabrics.
• For yardage pricing, see Fabric Yardage Pricing page
- E** Select power option.

NP	- No power
WP	- With power
- F** Select power type.

DCP	- Byrne Interlink IQ System w/Mini-Tap module OR jumper (Interlink IQ Infeed to power Interlink IQ Systems ordered seperately)
RPT	- Mini-Tap power module w/3-prong plug; add \$314

- G** Select Mini-Tap® module w/3-prong plug location.

LFPP	- Left front facing power
LRFP	- Left rear facing power
RFFP	- Right front facing power
RRFP	- Right rear facing power
- H** Select Byrne Interlink®IQ System type.

DCJ	- Byrne Interlink IQ System jumper only; add \$124
DSMOD	- Byrne Interlink IQ System w/Mini-Tap module
- I** Select Byrne Interlink®IQ System w/Mini-Tap® module quantity.

MOD1	- One module; add \$404
MOD2	- Two Modules; add \$807
MOD3	- Three modules; add \$1211
MOD4	- Four modules; add \$1614
- J** Select Byrne Interlink®IQ System w/Mini-Tap® module location(s).

LFPP	- Left front facing power
LRFP	- Left rear facing power
RFFP	- Right front facing power
RRFP	- Right rear facing power
LFLR	- Left front, left rear facing power
LFRF	- Left front, right front facing power
LFRR	- Left front, right rear facing power

- K** Select power module color.

MPB	- Black power module
MPS	- Silver power module
MPW	- White power module
- L** Select wood feet finish. Refer to the **Product Color Options** page in this price list.
- M** Select brushed aluminum feet finish. Refer to the **Product Color Options** page in this price list.
- N** Select moisture barrier.

MB	- Moisture barrier
NMB	- No moisture barrier

 See pricing column for moisture barrier upcharge.

INFORMATION

The removable seat design of MyPlace™ High-Back units allows for ease of installation and clean out, as well as inspection of electrical components. MyPlace™ High-Back offers UL recognized power components and an ETL-Listed power system (Byrne Interlink® IQ). MyPlace™ Lounge is not a UL listed Office Furnishing.

SPECIAL SERVICES

Special Carton Marking

With specially marked information N/C

Shipping
 Ships **partially assembled, FOB High Point, NC 27263, freight prepaid.** Freight class 250.

Specifications and prices are subject to change without prior notice.

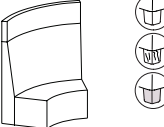

Features	MODEL NUMBER													Approx. Packaged Weight	Delivered Pricing	Moisture Barrier add to list price		
	Basic Model	Non-Cont or Fabric Cont 1	Pwr Opt	Pwr Type	MT Pwr Loc	IQ Pwr Type	IQ Mod Qty	IQ Pwr Loc	Power Color	Wd Feet Fin	Alum Feet Fin	Moist Barr						
concealed glides shown 	Concealed Glides	MCIH66/CGL/NC	<input type="checkbox"/>	<input type="checkbox"/>	<input type="checkbox"/>	<input type="checkbox"/>	<input type="checkbox"/>	<input type="checkbox"/>	<input type="checkbox"/>	<input type="checkbox"/>	<input type="checkbox"/>	<input type="checkbox"/>	<input type="checkbox"/>	<input type="checkbox"/>	<input type="checkbox"/>	170.00#	\$ 3519	\$ 282
	Poly Feet	MCIH66/PFT/NC	<input type="checkbox"/>	<input type="checkbox"/>	<input type="checkbox"/>	<input type="checkbox"/>	<input type="checkbox"/>	<input type="checkbox"/>	<input type="checkbox"/>	<input type="checkbox"/>	<input type="checkbox"/>	<input type="checkbox"/>	<input type="checkbox"/>	<input type="checkbox"/>	<input type="checkbox"/>	170.00#	3519	282
	Wood Feet	MCIH66/WFT/NC	<input type="checkbox"/>	<input type="checkbox"/>	<input type="checkbox"/>	<input type="checkbox"/>	<input type="checkbox"/>	<input type="checkbox"/>	<input type="checkbox"/>	<input type="checkbox"/>	<input type="checkbox"/>	<input type="checkbox"/>	<input type="checkbox"/>	<input type="checkbox"/>	<input type="checkbox"/>	170.00#	3645	282
	Aluminum Feet	MCIH66/AFT/NC	<input type="checkbox"/>	<input type="checkbox"/>	<input type="checkbox"/>	<input type="checkbox"/>	<input type="checkbox"/>	<input type="checkbox"/>	<input type="checkbox"/>	<input type="checkbox"/>	<input type="checkbox"/>	<input type="checkbox"/>	<input type="checkbox"/>	<input type="checkbox"/>	<input type="checkbox"/>	170.00#	3645	282
MCI66																		
Inside Back, 60° Curve, 60" High-Back - Non-contrast																		
<ul style="list-style-type: none"> • Non-contrast C.O.M = 7 yds • Gangers included to gang to other 60" high-back models. • Ganging to backless units or high-back back to side ganging (specify kit separately) • Does not gang with 32" low-back units • Cannot be retrofitted to 48" model • All base models have foot leveling capacity • Removable seat design, debris clean-out location, and painted wood base to protect against liquids. 																		
Overall Dimensions:																		
• W=54" D=26" H=60"																		
Seat Dimensions:																		
• D=18.5" H=18"																		
A B C D E F G H I J K L																		

HOW TO ORDER

- Indicate the following information on order form:
1. Quantity of each item.
 2. Model number, including options. See "How To Build a Model Number".
 3. Any special service required.

Note: • The indicates that a choice is required.
 • The absence of the indicates that no choice is required.
 • Alpha-numeric characters in place of indicate that no other alternatives are available.

HOW TO BUILD A MODEL NUMBER

- A** Select basic model.
- B** Select non-contrast or fabric contrast 1. Refer to ki.com/fabrics.
 • For yardage pricing, see Fabric Yardage Pricing page
- C** Select power option.
NP - No power
WP - With power
- D** Select power type.
DCP - Byrne Interlink IQ System w/Mini-Tap module OR jumper (Interlink IQ Infeed to power Interlink IQ Systems ordered separately)
RPT - Mini-Tap power module w/3-prong plug; add \$314
- E** Select Mini-Tap® module w/3-prong plug location.
LFFP - Left front facing power
LRFP - Left rear facing power
RFFP - Right front facing power
RRFP - Right rear facing power

- F** Select Byrne Interlink®IQ System type.
DCJ - Byrne Interlink IQ System jumper only; add \$124
DSMOD - Byrne Interlink IQ System w/Mini-Tap module
- G** Select Byrne Interlink®IQ System w/Mini-Tap® module quantity.
MOD1 - One module; add \$404
MOD2 - Two Modules; add \$807
MOD3 - Three modules; add \$1211
MOD4 - Four modules; add \$1614
- H** Select Byrne Interlink®IQ System w/Mini-Tap® module location(s).
LFFP - Left front facing power
LRFP - Left rear facing power
RFFP - Right front facing power
RRFP - Right rear facing power
LFLR - Left front, left rear facing power
LFRF - Left front, right front facing power
LFRR - Left front, right rear facing power
LRRF - Left rear, right front facing power
LRRR - Left rear, right rear facing power
RRRF - Right rear, right front facing power
RFLRRR - Left front, left rear, right rear facing power
LFRFLR - Left front, right front, left rear facing power
LFRFRR - Left front, right front, right rear facing power

- RFLRRR** - Right front, left rear, right rear facing power
LFRR - Left front, right rear facing power
- I** Select power module color.
MPB - Black power module
MPS - Silver power module
MPW - White power module
- J** Select wood feet finish. Refer to the **Product Color Options** page in this price list.
- K** Select brushed aluminum feet finish. Refer to the **Product Color Options** page in this price list.
- L** Select moisture barrier.
MB - Moisture barrier
NMB - No moisture barrier
 See pricing column for moisture barrier upcharge.

INFORMATION

The removable seat design of MyPlace™ High-Back units allows for ease of installation and clean out, as well as inspection of electrical components. MyPlace™ High-Back offers UL recognized power components and an ETL-Listed power system (Byrne Interlink® IQ). MyPlace™ Lounge is not a UL listed Office Furnishing.

SPECIAL SERVICES

Special Carton Marking

With specially marked information N/C

Shipping
 Ships **partially assembled, FOB High Point, NC 27263, freight prepaid**. Freight class 250.

Specifications and prices are subject to change without prior notice.



Features	Basic Model	MODEL NUMBER														Approx. Packaged Weight	Delivered Pricing	Moisture Barrier add to list price		
		Non-Cont or Fabric Cont 1	Fab Con 2	Fab Con 3	Pwr Opt	Pwr Type	MT Pwr Loc	IQ Pwr Type	IQ Mod Qty	IQ Pwr Loc	Power Color	Wd Feet Fin	Alum Feet Fin	Moist Barr						
concealed glides shown 	Concealed Glides	MCIH66/CGL/FC	<input type="checkbox"/>	<input type="checkbox"/>	<input type="checkbox"/>	<input type="checkbox"/>	<input type="checkbox"/>	<input type="checkbox"/>	<input type="checkbox"/>	<input type="checkbox"/>	<input type="checkbox"/>	<input type="checkbox"/>	<input type="checkbox"/>	<input type="checkbox"/>	<input type="checkbox"/>	<input type="checkbox"/>	<input type="checkbox"/>	170.00#	\$ 3583	\$ 282
	Poly Feet	MCIH66/PFT/FC	<input type="checkbox"/>	<input type="checkbox"/>	<input type="checkbox"/>	<input type="checkbox"/>	<input type="checkbox"/>	<input type="checkbox"/>	<input type="checkbox"/>	<input type="checkbox"/>	<input type="checkbox"/>	<input type="checkbox"/>	<input type="checkbox"/>	<input type="checkbox"/>	<input type="checkbox"/>	<input type="checkbox"/>	<input type="checkbox"/>	170.00#	3583	282
	Wood Feet	MCIH66/WFT/FC	<input type="checkbox"/>	<input type="checkbox"/>	<input type="checkbox"/>	<input type="checkbox"/>	<input type="checkbox"/>	<input type="checkbox"/>	<input type="checkbox"/>	<input type="checkbox"/>	<input type="checkbox"/>	<input type="checkbox"/>	<input type="checkbox"/>	<input type="checkbox"/>	<input type="checkbox"/>	<input type="checkbox"/>	<input type="checkbox"/>	170.00#	3710	282
	Aluminum Feet	MCIH66/AFT/FC	<input type="checkbox"/>	<input type="checkbox"/>	<input type="checkbox"/>	<input type="checkbox"/>	<input type="checkbox"/>	<input type="checkbox"/>	<input type="checkbox"/>	<input type="checkbox"/>	<input type="checkbox"/>	<input type="checkbox"/>	<input type="checkbox"/>	<input type="checkbox"/>	<input type="checkbox"/>	<input type="checkbox"/>	<input type="checkbox"/>	170.00#	3710	282
MCI66																				
Inside Back, 60° Curve, 60" High-Back - Contrast																				
<ul style="list-style-type: none"> • 1 = Base (Contrast 1) C.O.M. = 2 yd • 2 = Seat (Contrast 2) C.O.M. = 1 yd • 3 = Back (Contrast 3) C.O.M. = 6.75 yd • Gangers included to gang to other 60" High-Back models. • Ganging to backless units or High-Back back to side ganging (specify kit separately) • Does not gang with 32" Low-Back units • Cannot be retrofitted to 48" model • All base models have foot leveling capacity • Removable seat design, debris clean-out location, and painted wood base to protect against liquids. 																				
Overall Dimensions:																				
• W=54" D=26" H=60"																				
Seat Dimensions:																				
• D=18.5" H=18"																				
A B C D E F G H I J K L M N																				

HOW TO ORDER

- Indicate the following information on order form:
- Quantity of each item.
 - Model number, including options. See "How To Build a Model Number".
 - Any special service required.

Note: • The indicates that a choice is required.
 • The absence of the indicates that no choice is required.
 • Alpha-numeric characters in place of indicate that no other alternatives are available.

HOW TO BUILD A MODEL NUMBER

- A** Select basic model.
- B** Select non-contrast or fabric contrast 1. Refer to ki.com/fabrics.
• For yardage pricing, see Fabric Yardage Pricing page
- C** Select fabric contrast 2. Refer to ki.com/fabrics.
• For yardage pricing, see Fabric Yardage Pricing page
- D** Select fabric contrast 3. Refer to ki.com/fabrics.
• For yardage pricing, see Fabric Yardage Pricing page
- E** Select power option.
 NP - No power
 WP - With power
- F** Select power type.
 DCP - Byrne Interlink IQ System w/Mini-Tap module OR jumper (Interlink IQ Infeed to power Interlink IQ Systems ordered seperately)
 RPT - Mini-Tap power module w/3-prong plug; add \$314

- G** Select Mini-Tap® module w/3-prong plug location.
 LFFP - Left front facing power
 LRFP - Left rear facing power
 RFFP - Right front facing power
 RRFP - Right rear facing power
- H** Select Byrne Interlink®IQ System type.
 DCJ - Byrne Interlink IQ System jumper only; add \$124
 DSMOD - Byrne Interlink IQ System w/Mini-Tap module
- I** Select Byrne Interlink®IQ System w/Mini-Tap® module quantity.
 MOD1 - One module; add \$404
 MOD2 - Two Modules; add \$807
 MOD3 - Three modules; add \$1211
 MOD4 - Four modules; add \$1614
- J** Select Byrne Interlink®IQ System w/Mini-Tap® module location(s).
 LFFP - Left front facing power
 LRFP - Left rear facing power
 RFFP - Right front facing power
 RRFP - Right rear facing power
 LFLR - Left front, left rear facing power

- K** Select power module color.
 MPB - Black power module
 MPS - Silver power module
 MPW - White power module
- L** Select wood feet finish. Refer to the **Product Color Options** page in this price list.
- M** Select brushed aluminum feet finish. Refer to the **Product Color Options** page in this price list.
- N** Select moisture barrier.
 MB - Moisture barrier
 NMB - No moisture barrier

See pricing column for moisture barrier upcharge.

INFORMATION

The removable seat design of MyPlace™ High-Back units allows for ease of installation and clean out, as well as inspection of electrical components. MyPlace™ High-Back offers UL recognized power components and an ETL-Listed power system (Byrne Interlink® IQ). MyPlace™ Lounge is not a UL listed Office Furnishing.

SPECIAL SERVICES

Special Carton Marking
 With specially marked information N/C

Shipping
 Ships **partially assembled, FOB High Point, NC 27263, freight prepaid.** Freight class 250.

Specifications and prices are subject to change without prior notice.

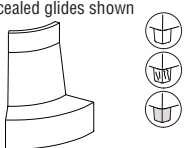

Features	MODEL NUMBER													Approx. Packaged Weight	Delivered Pricing	Moisture Barrier add to list price			
	Basic Model	Non-Cont or Fabric Cont 1	Pwr Opt	Pwr Type	MT Pwr Loc	IQ Pwr Type	IQ Mod Qty	IQ Pwr Loc	Power Color	Wd Feet Fin	Alum Feet Fin	Moist Barr							
concealed glides shown 	Concealed Glides	MCOH66/CGL/NC	<input type="checkbox"/>	<input type="checkbox"/>	<input type="checkbox"/>	<input type="checkbox"/>	<input type="checkbox"/>	<input type="checkbox"/>	<input type="checkbox"/>	<input type="checkbox"/>	<input type="checkbox"/>	<input type="checkbox"/>	<input type="checkbox"/>				185.00#	\$ 3256	\$ 261
	Poly Feet	MCOH66/PFT/NC	<input type="checkbox"/>	<input type="checkbox"/>	<input type="checkbox"/>	<input type="checkbox"/>	<input type="checkbox"/>	<input type="checkbox"/>	<input type="checkbox"/>	<input type="checkbox"/>	<input type="checkbox"/>	<input type="checkbox"/>	<input type="checkbox"/>				185.00#	3256	261
	Wood Feet	MCOH66/WFT/NC	<input type="checkbox"/>	<input type="checkbox"/>	<input type="checkbox"/>	<input type="checkbox"/>	<input type="checkbox"/>	<input type="checkbox"/>	<input type="checkbox"/>	<input type="checkbox"/>	<input type="checkbox"/>	<input type="checkbox"/>	<input type="checkbox"/>	<input type="checkbox"/>			185.00#	3382	261
	Aluminum Feet	MCOH66/AFT/NC	<input type="checkbox"/>	<input type="checkbox"/>	<input type="checkbox"/>	<input type="checkbox"/>	<input type="checkbox"/>	<input type="checkbox"/>	<input type="checkbox"/>	<input type="checkbox"/>	<input type="checkbox"/>	<input type="checkbox"/>	<input type="checkbox"/>	<input type="checkbox"/>	<input type="checkbox"/>		185.00#	3382	261

MCO66
Outside Back, 60° Curve, 60" High-Back - Non-contrast
 • Non-contrast C.O.M = 5.5 yds
 • Gangers included to gang to other 60" High-Back models.
 • Ganging to backless units or High-Back back to side ganging (specify kit separately)
 • Does not gang with 32" Low-Back units
 • Cannot be retrofitted to 48" model
 • All base models have foot leveling capacity
 • Removable seat design, debris clean-out location, and painted wood base to protect against liquids.
 Overall Dimensions:
 • W=54" D=26" H=60"
 Seat Dimensions:
 • D=18.5" H=18"

A B C D E F G H I J K L

HOW TO ORDER
 Indicate the following information on order form:
 1. Quantity of each item.
 2. Model number, including options. See "How To Build a Model Number".
 3. Any special service required.

Note: • The indicates that a choice is required.
 • The absence of the indicates that no choice is required.
 • Alpha-numeric characters in place of indicate that no other alternatives are available.

HOW TO BUILD A MODEL NUMBER

A Select basic model.

B Select non-contrast or fabric contrast 1. Refer to ki.com/fabrics.
 • For yardage pricing, see Fabric Yardage Pricing page

C Select power option.
NP - No power
WP - With power

D Select power type.
DCP - Byrne Interlink IQ System w/Mini-Tap module OR jumper (Interlink IQ Infeed to power Interlink IQ Systems ordered separately)
RPT - Mini-Tap power module w/3-prong plug; add \$314

E Select Mini-Tap® module w/3-prong plug location.
LFFP - Left front facing power
LRFP - Left rear facing power
RFFP - Right front facing power
RRFP - Right rear facing power

F Select Byrne Interlink®IQ System type.
DCJ - Byrne Interlink IQ System jumper only; add \$124
DSMOD - Byrne Interlink IQ System w/Mini-Tap module

G Select Byrne Interlink®IQ System w/Mini-Tap® module quantity.
MOD1 - One module; add \$404
MOD2 - Two Modules; add \$807
MOD3 - Three modules; add \$1211
MOD4 - Four modules; add \$1614

H Select Byrne Interlink®IQ System w/Mini-Tap® module location(s).
LFFP - Left front facing power
LRFP - Left rear facing power
RFFP - Right front facing power
RRFP - Right rear facing power
LFLR - Left front, left rear facing power
LFRF - Left front, right front facing power
LFRR - Left front, right rear facing power
LRRF - Left rear, right front facing power
LRRR - Left rear, right rear facing power
RRRF - Right rear, right front facing power
LFLRRR - Left front, left rear, right rear facing power

LFRFLR - Left front, right front, left rear facing power
LFRFRR - Left front, right front, right rear facing power
RFLRRR - Right front, left rear, right rear facing power
LFRFLRRR - Left front, right front, left rear, right rear facing power

I Select power module color.
MPB - Black power module
MPS - Silver power module
MPW - White power module

J Select wood feet finish. Refer to the **Product Color Options** page in this price list.

K Select brushed aluminum feet finish. Refer to the **Product Color Options** page in this price list.

L Select moisture barrier.
MB - Moisture barrier
NMB - No moisture barrier
 See pricing column for moisture barrier upcharge.

INFORMATION
 The removable seat design of MyPlace™ High-Back units allows for ease of installation and clean out, as well as inspection of electrical components. MyPlace™ High-Back offers UL recognized power components and an ETL-Listed power system (Byrne Interlink® IQ). MyPlace™ Lounge is not a UL listed Office Furnishing.

SPECIAL SERVICES
Special Carton Marking
 With specially marked information N/C
Shipping
 Ships **partially assembled, FOB High Point, NC 27263, freight prepaid**. Freight class 250.

Specifications and prices are subject to change without prior notice.

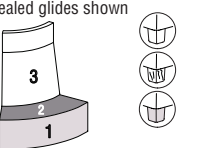

Features	MODEL NUMBER														Approx. Packaged Weight	Delivered Pricing	Moisture Barrier add to list price		
	Basic Model	Non-Cont or Fabric Cont 1	Fab Con 2	Fab Con 3	Pwr Opt	Pwr Type	MT Pwr Loc	IQ Pwr Type	IQ Mod Qty	IQ Pwr Loc	Power Color	Wd Feet Fin	Alum Feet Fin	Moist Barr					
concealed glides shown 	Concealed Glides	MCOH66/CGL/FC	<input type="checkbox"/>	<input type="checkbox"/>	<input type="checkbox"/>	<input type="checkbox"/>	<input type="checkbox"/>	<input type="checkbox"/>	<input type="checkbox"/>	<input type="checkbox"/>	<input type="checkbox"/>	<input type="checkbox"/>	<input type="checkbox"/>	<input type="checkbox"/>	<input type="checkbox"/>	<input type="checkbox"/>	185.00#	\$ 3313	\$ 261
	Poly Feet	MCOH66/PFT/FC	<input type="checkbox"/>	<input type="checkbox"/>	<input type="checkbox"/>	<input type="checkbox"/>	<input type="checkbox"/>	<input type="checkbox"/>	<input type="checkbox"/>	<input type="checkbox"/>	<input type="checkbox"/>	<input type="checkbox"/>	<input type="checkbox"/>	<input type="checkbox"/>	<input type="checkbox"/>	<input type="checkbox"/>	185.00#	3313	261
	Wood Feet	MCOH66/WFT/FC	<input type="checkbox"/>	<input type="checkbox"/>	<input type="checkbox"/>	<input type="checkbox"/>	<input type="checkbox"/>	<input type="checkbox"/>	<input type="checkbox"/>	<input type="checkbox"/>	<input type="checkbox"/>	<input type="checkbox"/>	<input type="checkbox"/>	<input type="checkbox"/>	<input type="checkbox"/>	<input type="checkbox"/>	185.00#	3441	261
	Aluminum Feet	MCOH66/AFT/FC	<input type="checkbox"/>	<input type="checkbox"/>	<input type="checkbox"/>	<input type="checkbox"/>	<input type="checkbox"/>	<input type="checkbox"/>	<input type="checkbox"/>	<input type="checkbox"/>	<input type="checkbox"/>	<input type="checkbox"/>	<input type="checkbox"/>	<input type="checkbox"/>	<input type="checkbox"/>	<input type="checkbox"/>	185.00#	3441	261

MCO66
Outside Back, 60° Curve, 60" High-Back - Contrast

- 1 = Base (Contrast 1) C.O.M. = 2 yd
- 2 = Seat (Contrast 2) C.O.M. = 1 yd
- 3 = Back (Contrast 3) C.O.M. = 3.25 yd
- Gangers included to gang to other 60" High-Back models.
- Ganging to backless units or High-Back back to side ganging (specify kit separately)
- Does not gang with 32" Low-Back units
- Cannot be retrofitted to 48" model
- All base models have foot leveling capacity
- Removable seat design, debris clean-out location, and painted wood base to protect against liquids.

Overall Dimensions:
• W=54" D=26" H=60"

Seat Dimensions:
• D=18.5" H=18"

HOW TO ORDER

Indicate the following information on order form:

- Quantity of each item.
- Model number, including options. See "How To Build a Model Number".
- Any special service required.

Note:

- The indicates that a choice is required.
- The absence of the indicates that no choice is required.
- Alpha-numeric characters in place of indicate that no other alternatives are available.

HOW TO BUILD A MODEL NUMBER

A Select basic model.

B Select non-contrast or fabric contrast 1. Refer to ki.com/fabrics.
• For yardage pricing, see Fabric Yardage Pricing page

C Select fabric contrast 2. Refer to ki.com/fabrics.
• For yardage pricing, see Fabric Yardage Pricing page

D Select fabric contrast 3. Refer to ki.com/fabrics.
• For yardage pricing, see Fabric Yardage Pricing page

E Select power option.
NP - No power
WP - With power

F Select power type.
DCP - Byrne Interlink IQ System w/Mini-Tap module OR jumper (Interlink IQ Infeed to power Interlink IQ Systems ordered seperately)
RPT - Mini-Tap power module w/3-prong plug; add

\$314

G Select Mini-Tap® module w/3-prong plug location.
LFFP - Left front facing power
LRFP - Left rear facing power
RFFP - Right front facing power
RRFP - Right rear facing power

H Select Byrne Interlink®IQ System type.
DCJ - Byrne Interlink IQ System jumper only; add \$124
DSMOD - Byrne Interlink IQ System w/Mini-Tap module

I Select Byrne Interlink®IQ System w/Mini-Tap® module quantity.
MOD1 - One module; add \$404
MOD2 - Two Modules; add \$807
MOD3 - Three modules; add \$1211
MOD4 - Four modules; add \$1614

J Select Byrne Interlink®IQ System w/Mini-Tap® module location(s).
LFFP - Left front facing power
LRFP - Left rear facing power
RFFP - Right front facing power
RRFP - Right rear facing power
LFLR - Left front, left rear facing power

LFRF - Left front, right front facing power
LFRR - Left front, right rear facing power
LRRF - Left rear, right front facing power
LRRR - Left rear, right rear facing power
RRRF - Right rear, right front facing power
LFLRRR - Left front, left rear, right rear facing power
LFRFLR - Left front, right front, left rear facing power
LFRFRR - Left front, right front, right rear facing power
RFLRRR - Right front, left rear, right rear facing power
LFRFLRRR - Left front, right front, left rear, right rear facing power

K Select power module color.
MPB - Black power module
MPS - Silver power module
MPW - White power module

L Select wood feet finish.
Refer to the **Product Color Options** page in this price list.

M Select brushed aluminum feet finish.
Refer to the **Product Color Options** page in this price list.

N Select moisture barrier.
MB - Moisture barrier

NMB - No moisture barrier
See pricing column for moisture barrier upcharge.

INFORMATION

The removable seat design of MyPlace™ High-Back units allows for ease of installation and clean out, as well as inspection of electrical components. MyPlace™ High-Back offers UL recognized power components and an ETL-Listed power system (Byrne Interlink® IQ). MyPlace™ Lounge is not a UL listed Office Furnishing.

SPECIAL SERVICES

Special Carton Marking
With specially marked information N/C

Shipping
Ships **partially assembled, FOB High Point, NC 27263, freight prepaid.** Freight class 250.

Specifications and prices are subject to change without prior notice.

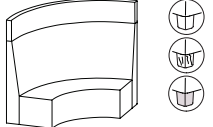

Features	MODEL NUMBER													Approx. Packaged Weight	Delivered Pricing	Moisture Barrier add to list price				
	Basic Model	Non-Cont or Fabric Cont 1	Pwr Opt	Pwr Type	MT Pwr Loc	IQ Pwr Type	IQ Mod Qty	IQ Pwr Loc	Power Color	Wd Feet Fin	Alum Feet Fin	Moist Barr								
concealed glides shown 	Concealed Glides	MCIH96/CGL/NC	<input type="checkbox"/>	<input type="checkbox"/>	<input type="checkbox"/>	<input type="checkbox"/>	<input type="checkbox"/>	<input type="checkbox"/>	<input type="checkbox"/>	<input type="checkbox"/>	<input type="checkbox"/>	<input type="checkbox"/>	<input type="checkbox"/>					260.00#	\$ 3897	\$ 335
	Poly Feet	MCIH96/PFT/NC	<input type="checkbox"/>	<input type="checkbox"/>	<input type="checkbox"/>	<input type="checkbox"/>	<input type="checkbox"/>	<input type="checkbox"/>	<input type="checkbox"/>	<input type="checkbox"/>	<input type="checkbox"/>	<input type="checkbox"/>	<input type="checkbox"/>					260.00#	3897	335
	Wood Feet	MCIH96/WFT/NC	<input type="checkbox"/>	<input type="checkbox"/>	<input type="checkbox"/>	<input type="checkbox"/>	<input type="checkbox"/>	<input type="checkbox"/>	<input type="checkbox"/>	<input type="checkbox"/>	<input type="checkbox"/>	<input type="checkbox"/>	<input type="checkbox"/>	<input type="checkbox"/>				260.00#	4022	335
	Aluminum Feet	MCIH96/AFT/NC	<input type="checkbox"/>	<input type="checkbox"/>	<input type="checkbox"/>	<input type="checkbox"/>	<input type="checkbox"/>	<input type="checkbox"/>	<input type="checkbox"/>	<input type="checkbox"/>	<input type="checkbox"/>	<input type="checkbox"/>	<input type="checkbox"/>	<input type="checkbox"/>				260.00#	4022	335
MCI96																				
Inside Back, 90° Curve, 60" High-Back - Non-contrast																				
<ul style="list-style-type: none"> • Non-contrast C.O.M = 10.5 yds • Gangers included to gang to other 60" High-Back models. • Ganging to backless units or High-Back back to side ganging (specify kit separately) • Does not gang with 32" Low-Back units • If Byrne Interlink®IQ Power is specified, an additional jumper is always included due to product size, impacting total count for one-infeed. See Planning Guide for more information. • All base models have foot leveling capacity • Removable seat design, debris clean-out location, and painted wood base to protect against liquids. • Overall Dimensions: <ul style="list-style-type: none"> • W=76.5" D=26" H=60" • Seat Dimensions: <ul style="list-style-type: none"> • D=18.5" H=18" 																				
A B C D E F G H I J K L																				

HOW TO ORDER

- Indicate the following information on order form:
1. Quantity of each item.
 2. Model number, including options. See "How To Build a Model Number".
 3. Any special service required.

Note: • The indicates that a choice is required.
 • The absence of the indicates that no choice is required.
 • Alpha-numeric characters in place of indicate that no other alternatives are available.

HOW TO BUILD A MODEL NUMBER

- A** Select basic model.
- B** Select non-contrast or fabric contrast 1.
 Refer to ki.com/fabrics.
 • For yardage pricing, see Fabric Yardage Pricing page
- C** Select power option.
 NP - No power
 WP - With power
- D** Select power type.
 DCP - Byrne Interlink IQ System w/Mini-Tap module OR jumper (Interlink IQ Infeed to power Interlink IQ Systems ordered separately)
 RPT - Mini-Tap power module w/3-prong plug; add \$314
- E** Select Mini-Tap® module w/3-prong plug location.
 LFFP - Left front facing power
 LRFP - Left rear facing power
 RFFP - Right front facing power
 RRFp - Right rear facing power
- F** Select Byrne Interlink®IQ System type.
 DCJ - Byrne Interlink IQ System jumper only; add \$183

DSMOD - Byrne Interlink IQ System w/Mini-Tap module

- G** Select Byrne Interlink®IQ System w/Mini-Tap® Module quantity.
 MOD1 - One module; add \$495
 MOD2 - Two Modules; add \$899
 MOD3 - Three modules; add \$1301
 MOD4 - Four modules; add \$1705
- H** Select Byrne Interlink®IQ System w/Mini-Tap® module location(s).
 LFFP - Left front facing power
 LRFP - Left rear facing power
 RFFP - Right front facing power
 RRFp - Right rear facing power
 LFLR - Left front, left rear facing power
 LFRF - Left front, right front facing power
 LFRR - Left front, right rear facing power
 LRRF - Left rear, right front facing power
 LRRR - Left rear, right rear facing power
 RRRF - Right rear, right front facing power
 RRRR - Right rear, right rear facing power
 LFLRRR - Left front, left rear, right rear facing power
 LFRFLR - Left front, right front, left rear facing power
 LFRFRR - Left front, right front, right rear facing power
 RFLRRR - Right front, left rear, right rear facing power
 LFRFLRRR - Left front, right front, left rear, right rear facing power

- I** Select power module color.
 MPB - Black power module
 MPS - Silver power module
 MPW - White power module
- J** Select wood feet finish.
 Refer to the **Product Color Options** page in this price list.
- K** Select brushed aluminum feet finish.
 Refer to the **Product Color Options** page in this price list.
- L** Select moisture barrier.
 MB - Moisture barrier
 NMB - No moisture barrier
 See pricing column for moisture barrier upcharge.

INFORMATION

The removable seat design of MyPlace™ High-Back units allows for ease of installation and clean out, as well as inspection of electrical components. MyPlace™ High-Back offers UL recognized power components and an ETL-Listed power system (Byrne Interlink® IQ). MyPlace™ Lounge is not a UL listed Office Furnishing.

SPECIAL SERVICES

Special Carton Marking

With specially marked information N/C

Shipping
 Ships **partially assembled, FOB High Point, NC 27263, freight prepaid.** Freight class 250.

Specifications and prices are subject to change without prior notice.



Features	MODEL NUMBER														Approx. Packaged Weight	Delivered Pricing	Moisture Barrier add to list price		
	Basic Model	Non-Cont or Fabric Cont 1	Fab Con 2	Fab Con 3	Pwr Opt	Pwr Type	MT Pwr Loc	IQ Pwr Type	IQ Mod Qty	IQ Pwr Loc	Power Color	Wd Feet Fin	Alum Feet Fin	Moist Barr					
concealed glides shown Concealed Glides	MCIH96/CGL/FC	<input type="checkbox"/>	<input type="checkbox"/>	<input type="checkbox"/>	<input type="checkbox"/>	<input type="checkbox"/>	<input type="checkbox"/>	<input type="checkbox"/>	<input type="checkbox"/>	<input type="checkbox"/>	<input type="checkbox"/>	<input type="checkbox"/>	<input type="checkbox"/>	<input type="checkbox"/>	<input type="checkbox"/>	<input type="checkbox"/>	260.00#	\$ 3967	\$ 335
Poly Feet	MCIH96/PFT/FC	<input type="checkbox"/>	<input type="checkbox"/>	<input type="checkbox"/>	<input type="checkbox"/>	<input type="checkbox"/>	<input type="checkbox"/>	<input type="checkbox"/>	<input type="checkbox"/>	<input type="checkbox"/>	<input type="checkbox"/>	<input type="checkbox"/>	<input type="checkbox"/>	<input type="checkbox"/>	<input type="checkbox"/>	<input type="checkbox"/>	260.00#	3967	335
Wood Feet	MCIH96/WFT/FC	<input type="checkbox"/>	<input type="checkbox"/>	<input type="checkbox"/>	<input type="checkbox"/>	<input type="checkbox"/>	<input type="checkbox"/>	<input type="checkbox"/>	<input type="checkbox"/>	<input type="checkbox"/>	<input type="checkbox"/>	<input type="checkbox"/>	<input type="checkbox"/>	<input type="checkbox"/>	<input type="checkbox"/>	<input type="checkbox"/>	260.00#	4095	335
Aluminum Feet	MCIH96/AFT/FC	<input type="checkbox"/>	<input type="checkbox"/>	<input type="checkbox"/>	<input type="checkbox"/>	<input type="checkbox"/>	<input type="checkbox"/>	<input type="checkbox"/>	<input type="checkbox"/>	<input type="checkbox"/>	<input type="checkbox"/>	<input type="checkbox"/>	<input type="checkbox"/>	<input type="checkbox"/>	<input type="checkbox"/>	<input type="checkbox"/>	260.00#	4095	335
<p>MCI96</p> <p>Inside Back, 90° Curve, 60" High-Back - Contrast</p> <ul style="list-style-type: none"> • 1 = Base (Contrast 1) C.O.M. = 2.5 yd • 2 = Seat (Contrast 2) C.O.M. = 1.5 yd • 3 = Back (Contrast 3) C.O.M. = 7.5 yd • Gangers included to gang to other 60" High-Back models. • Ganging to backless units or High-Back back to side ganging (specify kit separately) • Does not gang with 32" Low-Back units • Cannot be retrofitted to 48" model • If Byrne Interlink®IQ Power is specified, an additional jumper is always included due to product size, impacting total count for one-infeed. See Planning Guide for more information. • All base models have foot leveling capacity • Removable seat design, debris clean-out location, and painted wood base to protect against liquids. • Overall Dimensions: • W=76.5" D=26" H=60" • Seat Dimensions: • D=18.5" H=18" 																			
<p>A B C D E F G H I J K L M N</p>																			

HOW TO ORDER

- Indicate the following information on order form:
1. Quantity of each item.
 2. Model number, including options. See "How To Build a Model Number".
 3. Any special service required.

Note: • The indicates that a choice is required.
• The absence of the indicates that no choice is required.
• Alpha-numeric characters in place of indicate that no other alternatives are available.

HOW TO BUILD A MODEL NUMBER

- A** Select basic model.
- B** Select non-contrast or fabric contrast 1. Refer to ki.com/fabrics.
• For yardage pricing, see Fabric Yardage Pricing page
- C** Select fabric contrast 2. Refer to ki.com/fabrics.
• For yardage pricing, see Fabric Yardage Pricing page
- D** Select fabric contrast 3. Refer to ki.com/fabrics.
• For yardage pricing, see Fabric Yardage Pricing page
- E** Select power option.
NP - No power
WP - With power
- F** Select power type.
DCP - Byrne Interlink IQ System w/Mini-Tap module (jumper (Interlink IQ Infeed to power Interlink IQ Systems ordered seperately)
RPT - Mini-Tap power module w/3-prong plug; add \$314

- G** Select Mini-Tap® module w/3-prong plug location.
LFFP - Left front facing power
LRFP - Left rear facing power
RFFP - Right front facing power
RRFP - Right rear facing power
- H** Select Byrne Interlink®IQ System type.
DCJ - Byrne Interlink IQ System jumper only; add \$183
DSMOD - Byrne Interlink IQ System w/Mini-Tap module
- I** Select Byrne Interlink®IQ System w/Mini-Tap® module quantity.
MOD1 - One module; add \$495
MOD2 - Two Modules; add \$899
MOD3 - Three modules; add \$1301
MOD4 - Four modules; add \$1705
- J** Select Byrne Interlink®IQ System w/Mini-Tap® module location(s).
LFFP - Left front facing power
LRFP - Left rear facing power
RFFP - Right front facing power
RRFP - Right rear facing power
LFLR - Left front, left rear facing power
LFRF - Left front, right front facing power
LFRR - Left front, right rear facing power

- LRRF** - Left rear, right front facing power
LRRR - Left rear, right rear facing power
RRRF - Right rear, right front facing power
LFLRRR - Left front, left rear, right rear facing power
LFRFLR - Left front, right front, left rear facing power
LFRFRR - Left front, right front, right rear facing power
RFLRRR - Right front, left rear, right rear facing power
LFRFLRRR - Left front, right front, left rear, right rear facing power
- K** Select power module color.
MPB - Black power module
MPS - Silver power module
MPW - White power module
- L** Select wood feet finish. Refer to the **Product Color Options** page in this price list.
- M** Select brushed aluminum feet finish. Refer to the **Product Color Options** page in this price list.
- N** Select moisture barrier.
MB - Moisture barrier
NMB - No moisture barrier
See pricing column for moisture barrier upcharge.

INFORMATION

The removable seat design of MyPlace™ High-Back units allows for ease of installation and clean out, as well as inspection of electrical components. MyPlace™ High-Back offers UL recognized power components and an ETL-Listed power system (Byrne Interlink® IQ). MyPlace™ Lounge is not a UL listed Office Furnishing.

SPECIAL SERVICES

Special Carton Marking

With specially marked information N/C

Shipping
Ships **partially assembled, FOB High Point, NC 27263, freight prepaid.** Freight class 250.

Specifications and prices are subject to change without prior notice.

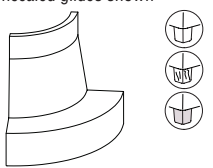

Features	Basic Model	MODEL NUMBER											Approx. Packaged Weight	Delivered Pricing	Moisture Barrier add to list price		
		Non-Cont or Fabric Cont 1	Pwr Opt	Pwr Type	MT Pwr Loc	IQ Pwr Type	IQ Mod Qty	IQ Pwr Loc	Power Color	Wd Feet Fin	Alum Feet Fin	Moist Barr					
concealed glides shown 	Concealed Glides	MCOH96/CGL/NC	<input type="checkbox"/>	<input type="checkbox"/>	<input type="checkbox"/>	<input type="checkbox"/>	<input type="checkbox"/>	<input type="checkbox"/>	<input type="checkbox"/>	<input type="checkbox"/>	<input type="checkbox"/>	<input type="checkbox"/>	<input type="checkbox"/>	<input type="checkbox"/>	210.00#	\$ 3651	\$ 290
	Poly Feet	MCOH96/PFT/NC	<input type="checkbox"/>	<input type="checkbox"/>	<input type="checkbox"/>	<input type="checkbox"/>	<input type="checkbox"/>	<input type="checkbox"/>	<input type="checkbox"/>	<input type="checkbox"/>	<input type="checkbox"/>	<input type="checkbox"/>	<input type="checkbox"/>	<input type="checkbox"/>	210.00#	3651	290
	Wood Feet	MCOH96/WFT/NC	<input type="checkbox"/>	<input type="checkbox"/>	<input type="checkbox"/>	<input type="checkbox"/>	<input type="checkbox"/>	<input type="checkbox"/>	<input type="checkbox"/>	<input type="checkbox"/>	<input type="checkbox"/>	<input type="checkbox"/>	<input type="checkbox"/>	<input type="checkbox"/>	210.00#	3778	290
	Aluminum Feet	MCOH96/AFT/NC	<input type="checkbox"/>	<input type="checkbox"/>	<input type="checkbox"/>	<input type="checkbox"/>	<input type="checkbox"/>	<input type="checkbox"/>	<input type="checkbox"/>	<input type="checkbox"/>	<input type="checkbox"/>	<input type="checkbox"/>	<input type="checkbox"/>	<input type="checkbox"/>	210.00#	3778	290

MCO96
Outside Back, 90° Curve, 60" High-Back - Non-contrast

- Non-contrast C.O.M = 7.5 yds
- Gangers included to gang to other 60" High-Back models.
- Ganging to backless units or High-Back back to side ganging (specify kit separately)
- Does not gang with 32" Low-Back units
- Cannot be retrofitted to 48" model
- If Byrne Interlink®IQ Power is specified, an additional jumper is always included due to product size, impacting total count for one-infeed. See Planning Guide for more information.
- All base models have foot leveling capacity
- Removable seat design, debris clean-out location, and painted wood base to protect against liquids.
- Overall Dimensions:
• W=76.5" D=26" H=60"
- Seat Dimensions:
• D=18.5" H=18"

HOW TO ORDER

- Indicate the following information on order form:
1. Quantity of each item.
 2. Model number, including options. See "How To Build a Model Number".
 3. Any special service required.

Note: • The indicates that a choice is required.
• The absence of the indicates that no choice is required.
• Alpha-numeric characters in place of indicate that no other alternatives are available.

HOW TO BUILD A MODEL NUMBER

- A** Select basic model.
- B** Select non-contrast or fabric contrast 1. Refer to ki.com/fabrics.
• For yardage pricing, see Fabric Yardage Pricing page
- C** Select power option.
NP - No power
WP - With power
- D** Select power type.
DCP - Byrne Interlink IQ System w/Mini-Tap module OR jumper (Interlink IQ Infeed to power Interlink IQ Systems ordered separately)
RPT - Mini-Tap power module w/3-prong plug; add \$314
- E** Select Byrne Interlink®IQ System w/Mini-Tap® module location(s).
LFFP - Left front facing power
LRFP - Left rear facing power
RFFP - Right front facing power
RRFP - Right rear facing power

- F** Select Byrne Interlink®IQ System type.
DCJ - Byrne Interlink IQ System jumper only; add \$183
DSMOD - Byrne Interlink IQ System w/Mini-Tap module
- G** Select Byrne Interlink®IQ System w/Mini-Tap® module quantity.
MOD1 - One module; add \$495
MOD2 - Two Modules; add \$899
MOD3 - Three modules; add \$1301
MOD4 - Four modules; add \$1705
- H** Select Byrne Interlink®IQ System w/Mini-Tap® module location(s).
LFFP - Left front facing power
LRFP - Left rear facing power
RFFP - Right front facing power
RRFP - Right rear facing power
LFLR - Left front, left rear facing power
LFRF - Left front, right front facing power
LFRR - Left front, right rear facing power
LRRF - Left rear, right front facing power
LRRR - Left rear, right rear facing power

- RRRF - Right rear, right front facing power
LFLRRR - Left front, left rear, right rear facing power
LFRFLR - Left front, right front, left rear facing power
LFRFRR - Left front, right front, right rear facing power
RFLRRR - Right front, left rear, right rear facing power
LFRFLRRR - Left front, right front, left rear, right rear facing power
- I** Select power module color.
MPB - Black power module
MPS - Silver power module
MPW - White power module
- J** Select wood feet finish. Refer to the **Product Color Options** page in this price list.
- K** Select brushed aluminum feet finish. Refer to the **Product Color Options** page in this price list.
- L** Select moisture barrier.
MB - Moisture barrier
NMB - No moisture barrier
See pricing column for moisture barrier upcharge.

INFORMATION

The removable seat design of MyPlace™ High-Back units allows for ease of installation and clean out, as well as inspection of electrical components. MyPlace™ High-Back offers UL recognized power components and an ETL-Listed power system (Byrne Interlink® IQ). MyPlace™ Lounge is not a UL listed Office Furnishing.

SPECIAL SERVICES

Special Carton Marking
With specially marked information N/C

Shipping
Ships **partially assembled, FOB High Point, NC 27263, freight prepaid.** Freight class 250.

Specifications and prices are subject to change without prior notice.



Features	MODEL NUMBER														Approx. Packaged Weight	Delivered Pricing	Moisture Barrier add to list price			
	Basic Model	Non-Cont or Fabric Cont 1	Fab Con 2	Fab Con 3	Pwr Opt	Pwr Type	MT Pwr Loc	IQ Pwr Type	IQ Mod Qty	IQ Pwr Loc	Power Color	Wd Feet Fin	Alum Feet Fin	Moist Barr						
concealed glides shown	Concealed Glides	MCOH96/CGL/FC	<input type="checkbox"/>	<input type="checkbox"/>	<input type="checkbox"/>	<input type="checkbox"/>	<input type="checkbox"/>	<input type="checkbox"/>	<input type="checkbox"/>	<input type="checkbox"/>	<input type="checkbox"/>	<input type="checkbox"/>	<input type="checkbox"/>	<input type="checkbox"/>			<input type="checkbox"/>	210.00#	\$ 3716	\$ 290
	Poly Feet	MCOH96/PFT/FC	<input type="checkbox"/>	<input type="checkbox"/>	<input type="checkbox"/>	<input type="checkbox"/>	<input type="checkbox"/>	<input type="checkbox"/>	<input type="checkbox"/>	<input type="checkbox"/>	<input type="checkbox"/>	<input type="checkbox"/>	<input type="checkbox"/>	<input type="checkbox"/>			<input type="checkbox"/>	210.00#	3716	290
	Wood Feet	MCOH96/WFT/FC	<input type="checkbox"/>	<input type="checkbox"/>	<input type="checkbox"/>	<input type="checkbox"/>	<input type="checkbox"/>	<input type="checkbox"/>	<input type="checkbox"/>	<input type="checkbox"/>	<input type="checkbox"/>	<input type="checkbox"/>	<input type="checkbox"/>	<input type="checkbox"/>	<input type="checkbox"/>		<input type="checkbox"/>	210.00#	3844	290
	Aluminum Feet	MCOH96/AFT/FC	<input type="checkbox"/>	<input type="checkbox"/>	<input type="checkbox"/>	<input type="checkbox"/>	<input type="checkbox"/>	<input type="checkbox"/>	<input type="checkbox"/>	<input type="checkbox"/>	<input type="checkbox"/>	<input type="checkbox"/>	<input type="checkbox"/>	<input type="checkbox"/>	<input type="checkbox"/>		<input type="checkbox"/>	210.00#	3844	290

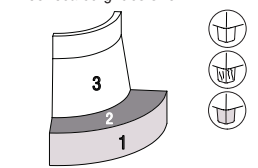

MCO96
Outside Back, 90° Curve, 60" High-Back - Contrast

- 1 = Base (Contrast 1) C.O.M. = 2.5 yd
- 2 = Seat (Contrast 2) C.O.M. = 1.75 yd
- 3 = Back (Contrast 3) C.O.M. = 4.5 yd
- Gangers included to gang to other 60" high-back models.
- Ganging to backless units or high-back back to side ganging (specify kit separately)
- Does not gang with 32" low-back units
- Cannot be retrofitted to 48" model
- If Byrne Interlink®IQ Power is specified, an additional jumper is always included due to product size, impacting total count for one-infeed. See Planning Guide for more information.
- All base models have foot leveling capacity
- Removable seat design, debris clean-out location, and painted wood base to protect against liquids.
- Overall Dimensions:
• W=76.5" D=26" H=60"
- Seat Dimensions:
• D=18.5" H=18"

A **B** **C** **D** **E** **F** **G** **H** **I** **J** **K** **L** **M** **N**

HOW TO ORDER
Indicate the following information on order form:
1. Quantity of each item.
2. Model number, including options. See "How To Build a Model Number".
3. Any special service required.

Note: • The indicates that a choice is required.
• The absence of the indicates that no choice is required.
• Alpha-numeric characters in place of indicate that no other alternatives are available.

HOW TO BUILD A MODEL NUMBER

A Select basic model.

B Select non-contrast or fabric contrast 1. Refer to ki.com/fabrics.
• For yardage pricing, see Fabric Yardage Pricing page

C Select fabric contrast 2. Refer to ki.com/fabrics.
• For yardage pricing, see Fabric Yardage Pricing page

D Select fabric contrast 3. Refer to ki.com/fabrics.
• For yardage pricing, see Fabric Yardage Pricing page

E Select power option.
NP - No power
WP - With power

F Select power type.
DCP - Byrne Interlink IQ System w/Mini-Tap module OR jumper (Interlink IQ Infeed to power Interlink IQ Systems ordered seperately)
RPT - Mini-Tap power module w/3-prong plug; add \$314

G Select Mini-Tap® module w/3-prong plug location.
LFFP - Left front facing power
LRFP - Left rear facing power
RFFP - Right front facing power
RRFP - Right rear facing power

H Select Byrne Interlink®IQ System type.
DCJ - Byrne Interlink IQ System jumper only; add \$183
DSMOD - Byrne Interlink IQ System w/Mini-Tap module

I Select Byrne Interlink®IQ System w/Mini-Tap® module quantity.
MOD1 - One module; add \$495
MOD2 - Two Modules; add \$899
MOD3 - Three modules; add \$1301
MOD4 - Four modules; add \$1705

J Select Byrne Interlink®IQ System w/Mini-Tap® module location(s).
LFFP - Left front facing power
LRFP - Left rear facing power
RFFP - Right front facing power
RRFP - Right rear facing power
LFLR - Left front, left rear facing power
LFRF - Left front, right front facing power

K Select power module color.
MPB - Black power module
MPS - Silver power module
MPW - White power module

L Select wood feet finish. Refer to the **Product Color Options** page in this price list.

M Select brushed aluminum feet finish. Refer to the **Product Color Options** page in this price list.

N Select moisture barrier.
MB - Moisture barrier
NMB - No moisture barrier
See pricing column for moisture barrier upcharge.

LFRR - Left front, right rear facing power
LRRF - Left rear, right front facing power
LRRR - Left rear, right rear facing power
RRRF - Right rear, right front facing power
LFLRRR - Left front, left rear, right rear facing power
LFRFLR - Left front, right front, left rear facing power
LFRFRR - Left front, right front, right rear facing power
RFLRRR - Right front, left rear, right rear facing power
LFRFLRRR - Left front, right front, left rear, right rear facing power

INFORMATION
The removable seat design of MyPlace™ High-Back units allows for ease of installation and clean out, as well as inspection of electrical components. MyPlace™ High-Back offers UL recognized power components and an ETL-Listed power system (Byrne Interlink® IQ). MyPlace™ Lounge is not a UL listed Office Furnishing.

SPECIAL SERVICES
Special Carton Marking
With specially marked information N/C
Shipping
Ships **partially assembled, FOB High Point, NC 27263, freight prepaid**. Freight class 250.

Specifications and prices are subject to change without prior notice.

Occasional & Inline Tables





Tabletops

Tabletops are made up of a high-pressure laminate surface that is glued to a 45 lb density particleboard core. The underside of the top and core is a $\frac{1}{32}$ " phenolic backer laminated for balanced construction and to help prevent moisture absorption in the core material. A 74P flat polymer edge band is offered in select KI colors (see color addendum). The finished tabletop thickness is $1\frac{1}{4}$ ".

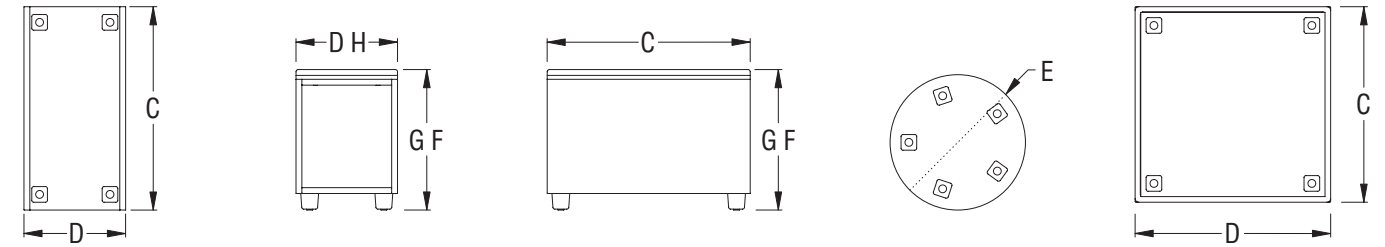
Inline Table Construction

Tables are constructed using $\frac{3}{4}$ " thick medium-density fiberboard core, high-pressure laminate facing on visible surfaces, phenolic backing sheet on non-visible surfaces and 2 mm polypropylene (73P) edge banding. Each table includes a centrally located divider panel. Panels are secured together using dowels, wood screws and glued joints. Inline tables can be ganged together with other inline tables or with MyPlace lounge pieces having consistent base styles (feet or glides).



Occasional & Inline Table Overall Dimension		A (Back Depth)	B (Seat Depth)	C (Overall Depth)	D (Overall Width)	E (Diameter)	F (Overall Height)	G (Seat Height)	H (Seat Width)
	MPT18R					18"	18"	18"	
	MPT26R					26"	18"	18"	
	MPTSQR		26"	26"	26"		18"	18"	
	MYPTED			26"	13"		18"		
	MPTEDP		26"	26"	13"		18"	18"	13"



Features	MODEL NUMBER							Approx. Packaged Weight	Delivered Pricing	Moisture Barrier add to list price	Laminate Grade 2 add to list price	Laminate Grade 3 add to list price	
	Basic Model	Non-Contrast or Fabric Contrast 1	Wood Feet Finish	Laminate Color	Edge Color (74P)	Aluminum Feet Finish	Moisture Barrier						
concealed glides shown MT18R 18" Round Table • Non-contrast C.O.M = 1.25 yds • Dia=18" H=18"	Concealed Glide, Non-contrast	MPT18R/CGL/NC	<input type="checkbox"/> <input type="checkbox"/> <input type="checkbox"/> <input type="checkbox"/>		<input type="checkbox"/> <input type="checkbox"/>	<input type="checkbox"/> <input type="checkbox"/>		<input type="checkbox"/> <input type="checkbox"/>	31.00#	\$ 861	\$ 126	\$ 19	\$ 120
	Poly Feet, Non-contrast	MPT18R/PFT/NC	<input type="checkbox"/> <input type="checkbox"/> <input type="checkbox"/> <input type="checkbox"/>		<input type="checkbox"/> <input type="checkbox"/>	<input type="checkbox"/> <input type="checkbox"/>		<input type="checkbox"/> <input type="checkbox"/>	31.00#	861	126	19	120
	Wood Feet, Non-contrast	MPT18R/WFT/NC	<input type="checkbox"/> <input type="checkbox"/> <input type="checkbox"/> <input type="checkbox"/>	<input type="checkbox"/> <input type="checkbox"/>	<input type="checkbox"/> <input type="checkbox"/>	<input type="checkbox"/> <input type="checkbox"/>		<input type="checkbox"/> <input type="checkbox"/>	31.00#	993	126	19	120
	Casters, Non-contrast	MPT18R/CST/NC	<input type="checkbox"/> <input type="checkbox"/> <input type="checkbox"/> <input type="checkbox"/>		<input type="checkbox"/> <input type="checkbox"/>	<input type="checkbox"/> <input type="checkbox"/>		<input type="checkbox"/> <input type="checkbox"/>	31.00#	861	126	19	120
	Aluminum Feet, Non-contrast	MPT18R/AFT/NC	<input type="checkbox"/> <input type="checkbox"/> <input type="checkbox"/> <input type="checkbox"/>		<input type="checkbox"/> <input type="checkbox"/>	<input type="checkbox"/> <input type="checkbox"/>	<input type="checkbox"/> <input type="checkbox"/>	<input type="checkbox"/> <input type="checkbox"/>	31.00#	993	126	19	120
concealed glides shown MT26R 26" Round Table • Non-contrast C.O.M = 1.75 yds • Ganging (specify kit separately) • Dia=26" H=18"	Concealed Glide, Non-contrast	MPT26R/CGL/NC	<input type="checkbox"/> <input type="checkbox"/> <input type="checkbox"/> <input type="checkbox"/>		<input type="checkbox"/> <input type="checkbox"/>	<input type="checkbox"/> <input type="checkbox"/>		<input type="checkbox"/> <input type="checkbox"/>	39.00#	\$ 1037	\$ 131	\$ 27	\$ 178
	Poly Feet, Non-contrast	MPT26R/PFT/NC	<input type="checkbox"/> <input type="checkbox"/> <input type="checkbox"/> <input type="checkbox"/>		<input type="checkbox"/> <input type="checkbox"/>	<input type="checkbox"/> <input type="checkbox"/>		<input type="checkbox"/> <input type="checkbox"/>	39.00#	1037	131	27	178
	Wood Feet, Non-contrast	MPT26R/WFT/NC	<input type="checkbox"/> <input type="checkbox"/> <input type="checkbox"/> <input type="checkbox"/>	<input type="checkbox"/> <input type="checkbox"/>	<input type="checkbox"/> <input type="checkbox"/>	<input type="checkbox"/> <input type="checkbox"/>		<input type="checkbox"/> <input type="checkbox"/>	39.00#	1166	131	27	178
	Casters, Non-contrast	MPT26R/CST/NC	<input type="checkbox"/> <input type="checkbox"/> <input type="checkbox"/> <input type="checkbox"/>		<input type="checkbox"/> <input type="checkbox"/>	<input type="checkbox"/> <input type="checkbox"/>		<input type="checkbox"/> <input type="checkbox"/>	39.00#	1037	131	27	178
	Aluminum Feet, Non-contrast	MPT26R/AFT/NC	<input type="checkbox"/> <input type="checkbox"/> <input type="checkbox"/> <input type="checkbox"/>		<input type="checkbox"/> <input type="checkbox"/>	<input type="checkbox"/> <input type="checkbox"/>	<input type="checkbox"/> <input type="checkbox"/>	<input type="checkbox"/> <input type="checkbox"/>	39.00#	1166	131	27	178
concealed glides shown MTSQR Square Table • Non-contrast C.O.M = 2.75 yds • Ganging (specify kit separately) • W=26" D=26" H=18"	Concealed Glide, Non-contrast	MPTSQR/CGL/NC	<input type="checkbox"/> <input type="checkbox"/> <input type="checkbox"/> <input type="checkbox"/>		<input type="checkbox"/> <input type="checkbox"/>	<input type="checkbox"/> <input type="checkbox"/>		<input type="checkbox"/> <input type="checkbox"/>	39.00#	\$ 1175	\$ 152	\$ 27	\$ 178
	Poly Feet, Non-contrast	MPTSQR/PFT/NC	<input type="checkbox"/> <input type="checkbox"/> <input type="checkbox"/> <input type="checkbox"/>		<input type="checkbox"/> <input type="checkbox"/>	<input type="checkbox"/> <input type="checkbox"/>		<input type="checkbox"/> <input type="checkbox"/>	39.00#	1175	152	27	178
	Wood Feet, Non-contrast	MPTSQR/WFT/NC	<input type="checkbox"/> <input type="checkbox"/> <input type="checkbox"/> <input type="checkbox"/>	<input type="checkbox"/> <input type="checkbox"/>	<input type="checkbox"/> <input type="checkbox"/>	<input type="checkbox"/> <input type="checkbox"/>		<input type="checkbox"/> <input type="checkbox"/>	39.00#	1306	152	27	178
	Casters, Non-contrast	MPTSQR/CST/NC	<input type="checkbox"/> <input type="checkbox"/> <input type="checkbox"/> <input type="checkbox"/>		<input type="checkbox"/> <input type="checkbox"/>	<input type="checkbox"/> <input type="checkbox"/>		<input type="checkbox"/> <input type="checkbox"/>	39.00#	1175	152	27	178
	Aluminum Feet, Non-contrast	MPTSQR/AFT/NC	<input type="checkbox"/> <input type="checkbox"/> <input type="checkbox"/> <input type="checkbox"/>		<input type="checkbox"/> <input type="checkbox"/>	<input type="checkbox"/> <input type="checkbox"/>	<input type="checkbox"/> <input type="checkbox"/>	<input type="checkbox"/> <input type="checkbox"/>	39.00#	1306	152	27	178

A **B** **C** **D** **E** **F** **G**

HOW TO ORDER

- Indicate the following information on order form:
- Quantity of each item.
 - Model number, including options. See "How To Build a Model Number".
 - Any special service required.

Note: • The indicates that a choice is required.
 • The absence of the indicates that no choice is required.
 • Alpha-numeric characters in place of indicate that no other alternatives are available.

HOW TO BUILD A MODEL NUMBER

- A** Select basic model.
- B** Select non-contrast or fabric contrast 1. Refer to ki.com/fabrics.
 • For yardage pricing, see Fabric Yardage Pricing page
- C** Select wood feet finish. Refer to the **Product Color Options** page in this price list.
- D** Select laminate color. Refer to the **Product Color Options** page in this price list. Refer to the **Product Color Options** page in this price list.
- E** Select 74P edge color. Refer to the **Product Color Options** page in this price list.
- F** Select brushed aluminum feet finish. Refer to the **Product Color Options** page in this price list.
- G** Select moisture barrier.

MB	- Moisture barrier
NMB	- No moisture barrier

 See pricing column for moisture barrier upcharge.

FINISH INFORMATION

ADDITIONAL LAMINATE OFFERING

KI offers laminates beyond those offered in the standard offering. Laminates that are currently available in the program can be viewed in KI product specification tools. Requests to add laminates to the program can be submitted via the product modification request process. Please note, requests to add laminates to the program must include the laminate manufacturers name, color/pattern number, and finish code. Edge options are limited to standard edge colors. If a matching edge is required, this will need to be requested thru the product modification request process and may be subject to additional costs. Due to varying manufacturing processes and quality issues with some laminates, some requests may be denied. Extended lead times and minimum order quantities may apply on orders containing special laminates. Contact the product modification team for questions or additional information regarding special laminates and pricing.

SPECIAL SERVICES

Special Carton Marking

With specially marked information N/C

Shipping
 Ships assembled, FOB High Point, NC 27263, freight prepaid. Freight class 250.

Specifications and prices are subject to change without prior notice.



Features	MODEL NUMBER										Approx. Packaged Weight	Delivered Pricing	Moisture Barrier add to list price	
	Basic Model	Non-Contrast or Fabric Contrast 1	Wood Feet Finish	Top Lam Color	Top Edge Color (73P)	Side/Div Lam Color	Side/Div Edge Color (73P)	Aluminum Feet Finish	Moisture Barrier					
concealed glides shown MPTED Rectangular In-Line Table, With Pad • Non-contrast C.O.M = .75 yd • Ganging (specify kit separately) • Table includes center divider, creating storage space. • Table height consistent with MyPlace Seating height. • Casters unavailable as standard. Overall Dimensions: • W=13" D=26" H=18"	Concealed Glide, Non-contrast	MPTEDP/CGL/NC	<input type="checkbox"/> <input type="checkbox"/> <input type="checkbox"/> <input type="checkbox"/>				<input type="checkbox"/> <input type="checkbox"/> <input type="checkbox"/> <input type="checkbox"/>	<input type="checkbox"/> <input type="checkbox"/>				47.50#	\$ 1306	\$ 184
	Poly Feet, Non-contrast	MPTEDP/PFT/NC	<input type="checkbox"/> <input type="checkbox"/> <input type="checkbox"/> <input type="checkbox"/>				<input type="checkbox"/> <input type="checkbox"/> <input type="checkbox"/> <input type="checkbox"/>	<input type="checkbox"/> <input type="checkbox"/>				45.50#	1306	184
	Wood Feet, Non-contrast	MPTEDP/WFT/NC	<input type="checkbox"/> <input type="checkbox"/> <input type="checkbox"/> <input type="checkbox"/>	<input type="checkbox"/> <input type="checkbox"/>			<input type="checkbox"/> <input type="checkbox"/> <input type="checkbox"/> <input type="checkbox"/>	<input type="checkbox"/> <input type="checkbox"/>				45.50#	1346	184
	Aluminum Feet, Non-contrast	MPTEDP/AFT/NC	<input type="checkbox"/> <input type="checkbox"/> <input type="checkbox"/> <input type="checkbox"/>				<input type="checkbox"/> <input type="checkbox"/> <input type="checkbox"/> <input type="checkbox"/>	<input type="checkbox"/> <input type="checkbox"/>	<input type="checkbox"/> <input type="checkbox"/>			45.50#	1346	184
concealed glides shown MTED Rectangular In-Line Table, Without Pad • Ganging (specify kit separately) • Table includes center divider, creating storage space. • Table height consistent with MyPlace Seating height. • Casters unavailable as standard. Overall Dimensions: • W=13" D=26" H=18"	Concealed Glide	MYPTED/CGL		<input type="checkbox"/> <input type="checkbox"/>	<input type="checkbox"/> <input type="checkbox"/>	<input type="checkbox"/> <input type="checkbox"/> <input type="checkbox"/> <input type="checkbox"/>	<input type="checkbox"/> <input type="checkbox"/>					46.50#	\$ 1037	N/A
	Poly Feet	MYPTED/PFT		<input type="checkbox"/> <input type="checkbox"/>	<input type="checkbox"/> <input type="checkbox"/>	<input type="checkbox"/> <input type="checkbox"/> <input type="checkbox"/> <input type="checkbox"/>	<input type="checkbox"/> <input type="checkbox"/>					52.50#	1037	N/A
	Wood Feet	MYPTED/WFT		<input type="checkbox"/> <input type="checkbox"/>	<input type="checkbox"/> <input type="checkbox"/>	<input type="checkbox"/> <input type="checkbox"/> <input type="checkbox"/> <input type="checkbox"/>	<input type="checkbox"/> <input type="checkbox"/>					52.50#	1078	N/A
	Aluminum Feet	MYPTED/AFT		<input type="checkbox"/> <input type="checkbox"/>	<input type="checkbox"/> <input type="checkbox"/>	<input type="checkbox"/> <input type="checkbox"/> <input type="checkbox"/> <input type="checkbox"/>	<input type="checkbox"/> <input type="checkbox"/>	<input type="checkbox"/> <input type="checkbox"/>				52.50#	1078	N/A
			A	B	C	D	E	F	G	H	I			

HOW TO ORDER

Indicate the following information on order form:

- Quantity of each item.
- Model number, including options. See "How To Build a Model Number".
- Any special service required.

Note:

- The indicates that a choice is required.
- The absence of the indicates that no choice is required.
- Alpha-numeric characters in place of indicate that no other alternatives are available.

HOW TO BUILD A MODEL NUMBER

A Select basic model.

B Select non-contrast or fabric contrast 1. Refer to ki.com/fabrics.
 • For yardage pricing, see Fabric Yardage Pricing page

C Select wood feet finish. Refer to the **Product Color Options** page in this price list.

D Select laminate top color. Refer to the **Product Color Options** page in this price list.

E Select top edge color. Refer to the **Product Color Options** page in this price list.

F Select laminate side/divider color. Refer to the **Product Color Options** page in this price list.

G Select side/divider edge color. Refer to the **Product Color Options** page in this price list.

H Select brushed aluminum feet finish. Refer to the **Product Color Options** page in this price list.

I Select moisture barrier.
MB - Moisture barrier
NMB - No moisture barrier
 See pricing column for moisture barrier upcharge.

SPECIAL SERVICES

Special Carton Marking
 With specially marked information N/C

Shipping
 Ships assembled, FOB High Point, NC 27263, freight prepaid. Freight class 250.

Specifications and prices are subject to change without prior notice.



Wood Shelving

Construction

Shelving construction is modular type, utilizing Oak or Maple veneered particleboard. Shelving units are designed to be specified in a starter and adder configuration. All shelving units are single-sided and designed to be oriented with an outside facing curve.

Straight End Panels

Straight end panels are constructed using 1" thick Oak or Maple veneered particleboard. All edges are finished with matching veneer edge banding. Vertical rows of holes are drilled in 1 1/4" increments near the front and rear of one side of the panel for shelf attachment and height adjustment. Panels are drilled at front, rear, top, and bottom for embedding internal and external threaded bushings. Straight end panels are attached to base and top assemblies using 5/16"-18 x 2" hex head bolts and washers.

Straight Adder (Shared) Panels

Straight adder panels are constructed using 1" thick Oak or Maple veneered particleboard. All edges are finished with matching veneer edge banding. Vertical rows of holes are drilled in 1 1/4" increments near the front and rear on both sides of each panel for shelf attachment and height adjustment. Shelf pin holes are bored on both sides of the panel but staggered so that pins can be deeply seated. Panels are drilled through at front, rear, top, and bottom for attachment to tops and bases with 5/16"-18 x 4 1/2" hex head bolts, nuts, and washers.

Base

The base assembly is 3 1/4" tall, constructed of Oak or Maple veneered particleboard. A full length 2" x 3/4" rail is tenoned to the inside of the front. 1 1/4" x 1 1/4" bolting cleats are glued and stapled perpendicular at the ends of the rail and drilled to allow assembly bolts to pass through. A second full-length rail is glued and stapled to the rear of the bolting cleats for support and proper alignment. Bases are designed to support a 3/4" thick base shelf which rests on top of the base assembly and is secured in place by the back panel once installed.

Shelves

Base Shelf

The four bolts used to attach the end/adder panels to the base assembly are concealed by the 3 1/4" tall base front and 3/4" thick base shelf once installed. The base shelf rests on top of the 3 1/4" tall front facing/trim of the base assembly ensuring hardware is not visible after installation. Base shelf includes a recessed channel to accept the 1/4" thick back panel which secures the shelf without the use of hardware.

Top Shelf

The four bolts used to attach the top shelf assembly are concealed by the 2 5/16" tall top front which ships pre assembled to the underside of the top shelf ensuring hardware is not visible after installation.

Adjustable Shelf

A black metal anti-tip clip is included for each adjustable shelf. Clips are installed by sliding the clip onto either side of the shelf at the location of the rear shelf pin. The bottom of the clip with circular hole will be secured in place by positioning it over/around the shelf pin. The shelf will be secured between the top metal tab and the shelf pin which will prevent the shelf from tipping or falling forward if weight is unevenly distributed towards the front edge of the shelf.

Back Panel

Back panels are 1/4" thick constructed using 3-ply or 5-ply furniture-grade Oak or Maple veneered plywood and are finished on both sides to match shelving.

Wood Adjustable Shelf

Shelves are constructed using 1" thick Oak or Maple veneered particleboard. All edges are finished with matching veneer edge banding. Adjustable shelves are notched 3/8" wide by 3/16" high by 3/4" deep on the underside to set firmly on 1" long by 5/16" diameter cadmium plated threaded shelf pins. Shelf depths are nominal.



Laminate Shelving

Construction

Shelving construction is modular type, utilizing thermally-fused laminate panels. Shelving units are designed to be specified in a starter and adder configuration. All shelving units are single-sided and oriented with an outside facing curve.

Straight End Panels

Straight end panels are constructed using 1" thick thermally-fused laminate. All edges are finished with matching 2 mm PVC edge banding. Vertical rows of holes are drilled in 1 1/4" increments near the front and rear of one side of the panel for shelf attachment and height adjustment. Panels are drilled at front, rear, top, and bottom for embedding internal and external threaded bushings. Straight end panels are attached to base and top assemblies using 5/16" - 18 x 2" hex-head bolts and washers.

Straight Adder (Shared) Panels

Straight adder panels are constructed using 1" thick thermally-fused laminate. All edges are finished with matching 2 mm PVC edge banding. Shelf pin holes are bored on both sides of the panel but staggered allowing pins to be deeply seated. Panels are drilled through at front, rear, top, and bottom for attachment to bases and tops with 5/16" - 18 x 4 1/2" hex-head bolts, nuts, and washers.

Base

The base assembly is 3 1/4" tall and constructed using 3/4" thick high-pressure laminate panel with a 3/4" thick base shelf. A full-length 2" x 3/4" rail is tenoned to the inside of the front. 1 1/4" x 1 1/4" bolting cleats are glued and stapled perpendicular at the ends of the rail and drilled to allow assembly bolts to pass through. A second full-length rail is glued and stapled to the rear of the bolting cleats for support and proper alignment. Bases are manufactured so the base shelf rests on top of the base assembly.

Top Shelf

Top shelf is constructed using 3/4" thick thermally-fused laminate. Edges are finished on all sides with matching 2 mm PVC edge banding. The four bolts used to attach the top shelf assembly are concealed by the 2 5/16" tall top front which ships pre assembled to the underside of the top shelf ensuring hardware is not visible after installation.

Adjustable Shelf

A black metal anti-tip clip is included for each adjustable shelf. Clips are installed by sliding the clip onto either side of the shelf at the location of the rear shelf pin. The bottom of the clip with circular hole will be secured in place by positioning it over/around the shelf pin. The shelf will be secured between the top metal tab and the shelf pin which will prevent the shelf from tipping or falling forward if weight is unevenly distributed towards the front edge of the shelf.

Back Panel





Back panels are constructed using 1/4" thick high-pressure laminate and are finished on both sides to match shelving finish.

Laminate Adjustable Shelf

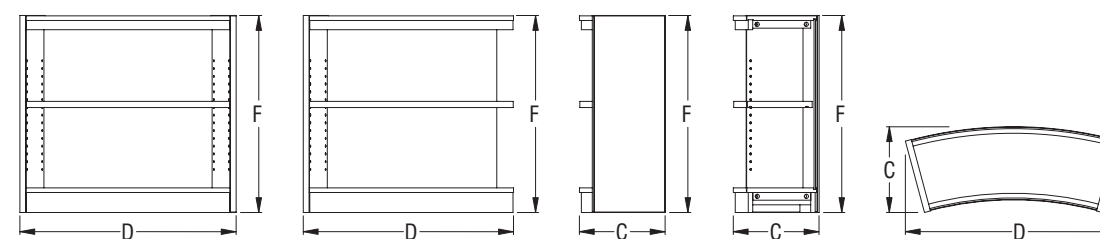
Shelves are constructed using 1" thick thermally-fused laminate. Front and back edges are finished with matching 2 mm PVC edge banding. Adjustable shelves are notched 3/8" wide by 3/16" high 3/4" deep on the underside to set firmly on 1" long by 5/16" diameter cadmium plated threaded shelf pins. Shelf depths are nominal.

MyPlace Curved Shelving



MyPlace Curved Shelving Overall Dimension								
Model	A (Back Depth)	B (Seat Depth)	C (Overall Depth)	D (Overall Width)	E (Diameter)	F (Overall Height)	G (Seat Height)	H (Seat Width)
 MPCS30S			12"	35 1/4"		32"		
 MPCS30A			12"	34 1/4"		32"		
 MPCS45S			12"	51 1/2"		32"		
 MPCS45A			12"	50 1/2"		32"		



MODEL	D x W	MODEL NUMBER		Approx. Packaged Weight	Delivered Pricing
		Basic Model	Finish		
<p>MPCS</p> <p>30 Degree Curved Shelving, Outside-Facing, 32" H Starter, Thermally Fused Laminate (TFL)</p> <ul style="list-style-type: none"> Includes 2 straight end panels (1 left, 1 right) & 1 adjustable shelf Back panel finished on both sides Designed for use with MyPlace Low Back, Curve Seating - Specify 1 starter & 1 adder with 2 MyPlace 30 Degree Inside Curve, Low-Back Units (MPCI30) OR 1 MyPlace 60 Degree Inside Curve, Low-Back Unit (MPCI60) Book Capacity: Academic - 63, Standard - 81, Childrens - 144 	12" x 35-1/4"	MPCSO30ST	<input type="checkbox"/> <input type="checkbox"/>	93.0#	\$ 2397
<p>MPCS</p> <p>30 Degree Curved Shelving, Outside-Facing, 32" H Starter, Oak</p> <ul style="list-style-type: none"> Includes 2 straight end panels (1 left, 1 right) & 1 adjustable shelf Back panel finished on both sides Designed for use with MyPlace Low Back, Curve Seating - Specify 1 starter & 1 adder with 2 MyPlace 30 Degree Inside Curve, Low-Back Units (MPCI30) OR 1 MyPlace 60 Degree Inside Curve, Low-Back Unit (MPCI60) Book Capacity: Academic - 63, Standard - 81, Childrens - 144 	12" x 35-1/4"	MPCSO30SO	<input type="checkbox"/> <input type="checkbox"/>	93.0#	\$ 2488
<p>MPCS</p> <p>30 Degree Curved Shelving, Outside-Facing, 32" H Starter, Maple</p> <ul style="list-style-type: none"> Includes 2 straight end panels (1 left, 1 right) & 1 adjustable shelf Back panel finished on both sides Designed for use with MyPlace Low Back, Curve Seating - Specify 1 starter & 1 adder with 2 MyPlace 30 Degree Inside Curve, Low-Back Units (MPCI30) OR 1 MyPlace 60 Degree Inside Curve, Low-Back Unit (MPCI60) Book Capacity: Academic - 63, Standard - 81, Childrens - 144 	12" x 35-1/4"	MPCSO30SM	<input type="checkbox"/> <input type="checkbox"/>	93.0#	\$ 2681

A

B

HOW TO ORDER

- Indicate the following information on order form:
- Quantity of each item.
 - Model number, including options. See "How To Build a Model Number".
 - Any special service required.

Note:

- The indicates that a choice is required.
- The absence of the indicates that no choice is required.
- Alpha-numeric characters in place of indicate that no other alternatives are available.

HOW TO BUILD A MODEL NUMBER

- A** Select basic model.
- B** Select finish. Refer to the **Product Color Options** page in this price list.

SPECIAL SERVICES

Special Carton Marking

With specially marked information N/C

Shipping
Ships **knocked down, FOB Factory of origin, freight prepaid.** Freight class 125.

Specifications and prices are subject to change without prior notice.



	MODEL	D x W	MODEL NUMBER		Approx. Packaged Weight	Delivered Pricing
			Basic Model	Finish		
<p>MPCS</p>	30 Degree Curved Shelving, Outside-Facing, 32" H Adder, Thermally Fused Laminate (TFL) • Includes 1 straight adder (shared) panel only • Back panel finished on both sides • Designed for use with MyPlace Low Back, Curve Seating - Specify 1 starter & 1 adder with 2 MyPlace 30 Degree Inside Curve, Low-Back Units (MPCI30) OR 1 MyPlace 60 Degree Inside Curve, Low-Back Unit (MPCI60) • Book Capacity: Academic - 63, Standard - 81, Childrens - 144	12" x 34-1/4"	MPCSO30AT	<input type="checkbox"/> <input type="checkbox"/>	83.0#	\$ 2139
<p>MPCS</p>	30 Degree Curved Shelving, Outside-Facing, 32" H Adder, Oak • Includes 1 straight adder (shared) panel only • Back panel finished on both sides • Designed for use with MyPlace Low Back, Curve Seating - Specify 1 starter & 1 adder with 2 MyPlace 30 Degree Inside Curve, Low-Back Units (MPCI30) OR 1 MyPlace 60 Degree Inside Curve, Low-Back Unit (MPCI60) • Book Capacity: Academic - 63, Standard - 81, Childrens - 144	12" x 34-1/4"	MPCSO30AO	<input type="checkbox"/> <input type="checkbox"/>	83.0#	\$ 2234
<p>MPCS</p>	30 Degree Curved Shelving, Outside-Facing, 32" H Adder, Maple • Includes 1 straight adder (shared) panel only • Back panel finished on both sides • Designed for use with MyPlace Low Back, Curve Seating - Specify 1 starter & 1 adder with 2 MyPlace 30 Degree Inside Curve, Low-Back Units (MPCI30) OR 1 MyPlace 60 Degree Inside Curve, Low-Back Unit (MPCI60) • Book Capacity: Academic - 63, Standard - 81, Childrens - 144	12" x 34-1/4"	MPCSO30AM	<input type="checkbox"/> <input type="checkbox"/>	83.0#	\$ 2343

A

B

HOW TO ORDER

- Indicate the following information on order form:
- Quantity of each item.
 - Model number, including options. See "How To Build a Model Number".
 - Any special service required.

Note: • The indicates that a choice is required.
 • The absence of the indicates that no choice is required.
 • Alpha-numeric characters in place of indicate that no other alternatives are available.

HOW TO BUILD A MODEL NUMBER

- A** Select basic model.
B Select finish.
 Refer to the **Product Color Options** page in this price list.

SPECIAL SERVICES

Special Carton Marking

With specially marked information N/C

Shipping
 Ships **knocked down, FOB Factory of origin, freight prepaid.** Freight class 125.

Specifications and prices are subject to change without prior notice.

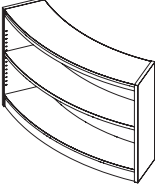
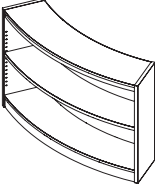
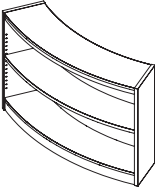

	MODEL	D x W	MODEL NUMBER		Approx. Packaged Weight	Delivered Pricing
			Basic Model	Finish		
 <p>MPCS</p>	45 Degree Curved Shelving, Outside-Facing, 32" H Starter, Thermally Fused Laminate (TFL) <ul style="list-style-type: none"> Includes 2 straight end panels (1 left, 1 right) & 1 adjustable shelf Back panel finished on both sides Designed for use with MyPlace Low Back, Curve Seating - Specify 1 starter & 1 adder with 2 MyPlace 45 Degree Inside Curve, Low-Back Units (MPCI45) OR 1 MyPlace 90 Degree Inside Curve, Low-Back Unit (MPICB) Book Capacity: Academic - 73, Standard - 92, Childrens - 154 	12" x 51-1/2"	MPCSO45ST	<input type="checkbox"/> <input type="checkbox"/>	105.0#	\$ 2838
 <p>MPCS</p>	45 Degree Curved Shelving, Outside-Facing, 32" H Starter, Oak <ul style="list-style-type: none"> Includes 2 straight end panels (1 left, 1 right) & 1 adjustable shelf Back panel finished on both sides Designed for use with MyPlace Low Back, Curve Seating - Specify 1 starter & 1 adder with 2 MyPlace 45 Degree Inside Curve, Low-Back Units (MPCI45) OR 1 MyPlace 90 Degree Inside Curve, Low-Back Unit (MPICB) Book Capacity: Academic - 73, Standard - 92, Childrens - 154 	12" x 51-1/2"	MPCSO45SO	<input type="checkbox"/> <input type="checkbox"/>	105.0#	\$ 2915
 <p>MPCS</p>	45 Degree Curved Shelving, Outside-Facing, 32" H Starter, Maple <ul style="list-style-type: none"> Includes 2 straight end panels (1 left, 1 right) & 1 adjustable shelf Back panel finished on both sides Designed for use with MyPlace Low Back, Curve Seating - Specify 1 starter & 1 adder with 2 MyPlace 45 Degree Inside Curve, Low-Back Units (MPCI45) OR 1 MyPlace 90 Degree Inside Curve, Low-Back Unit (MPICB) Book Capacity: Academic - 73, Standard - 92, Childrens - 154 	12" x 51-1/2"	MPCSO45SM	<input type="checkbox"/> <input type="checkbox"/>	105.0#	\$ 3246

A

B

HOW TO ORDER

- Indicate the following information on order form:
- Quantity of each item.
 - Model number, including options. See "How To Build a Model Number".
 - Any special service required.

Note:

- The indicates that a choice is required.
- The absence of the indicates that no choice is required.
- Alpha-numeric characters in place of indicate that no other alternatives are available.

HOW TO BUILD A MODEL NUMBER

- A** Select basic model.
- B** Select finish. Refer to the **Product Color Options** page in this price list.

SPECIAL SERVICES

Special Carton Marking

With specially marked information N/C

Shipping
Ships **knocked down, FOB Factory of origin, freight prepaid.** Freight class 125.

Specifications and prices are subject to change without prior notice.



	MODEL	D x W	MODEL NUMBER		Approx. Packaged Weight	Delivered Pricing
			Basic Model	Finish		
<p>MPCS</p>	45 Degree Curved Shelving, Outside-Facing, 32" H Adder, Thermally Fused Laminate (TFL) • Includes 1 straight adder (shared) panel only • Back panel finished on both sides • Designed for use with MyPlace Low Back, Curve Seating - Specify 1 starter & 1 adder with 2 MyPlace 45 Degree Inside Curve, Low-Back Units (MPCI45) OR 1 MyPlace 90 Degree Inside Curve, Low-Back Unit (MPICB) • Book Capacity: Academic - 73, Standard - 92, Childrens - 154	12" x 50-1/2"	MPCSO45AT	<input type="checkbox"/> <input type="checkbox"/>	95.0#	\$ 2429
<p>MPCS</p>	45 Degree Curved Shelving, Outside-Facing, 32" H Adder, Oak • Includes 1 straight adder (shared) panel only • Back panel finished on both sides • Designed for use with MyPlace Low Back, Curve Seating - Specify 1 starter & 1 adder with 2 MyPlace 45 Degree Inside Curve, Low-Back Units (MPCI45) OR 1 MyPlace 90 Degree Inside Curve, Low-Back Unit (MPICB) • Book Capacity: Academic - 73, Standard - 92, Childrens - 154	12" x 50-1/2"	MPCSO45AO	<input type="checkbox"/> <input type="checkbox"/>	95.0#	\$ 2452
<p>MPCS</p>	45 Degree Curved Shelving, Outside-Facing, 32" H Adder, Maple • Includes 1 straight adder (shared) panel only • Back panel finished on both sides • Designed for use with MyPlace Low Back, Curve Seating - Specify 1 starter & 1 adder with 2 MyPlace 45 Degree Inside Curve, Low-Back Units (MPCI45) OR 1 MyPlace 90 Degree Inside Curve, Low-Back Unit (MPICB) • Book Capacity: Academic - 73, Standard - 92, Childrens - 154	12" x 50-1/2"	MPCSO45AM	<input type="checkbox"/> <input type="checkbox"/>	95.0#	\$ 2665

A

B

HOW TO ORDER

- Indicate the following information on order form:
- Quantity of each item.
 - Model number, including options. See "How To Build a Model Number".
 - Any special service required.

Note:

- The indicates that a choice is required.
- The absence of the indicates that no choice is required.
- Alpha-numeric characters in place of indicate that no other alternatives are available.

HOW TO BUILD A MODEL NUMBER

- A** Select basic model.
- B** Select finish.
Refer to the **Product Color Options** page in this price list.

SPECIAL SERVICES

Special Carton Marking

With specially marked information N/C

Shipping
Ships **knocked down, FOB Factory of origin, freight prepaid.** Freight class 125.

Specifications and prices are subject to change without prior notice.

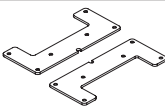
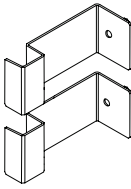
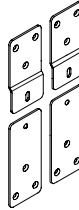

MODEL	MODEL NUMBER		Approx. Packaged Weight	Delivered Pricing
	Basic Model			
 MPM Ganging Kit <ul style="list-style-type: none"> • One ganging kit to be specified for each lounge-to-lounge connection • Ganging specified for use with glides, wood feet or poly feet • Ganging kit also used with In-Line Table models MPTEDP and MYPTED • For use to gang backless, 32" low-back units, or table units together • Not for use ganging low-back to high-back, or high-back models 	MPGANGKIT		0.0#	\$ 114
 MPM High-Back to Low-Back Gangers <ul style="list-style-type: none"> • For use to gang a high-back (48" or 60" height) model to a backless unit • For use with linear/side-to-side planning configurations • Not for use with high-back to high-back models • Ships as a kit; one ganging kit to be specified for each lounge-to-lounge connection. 	MPHBLBGANG		0.0#	\$ 78
 MPM High-Back Model Back-to-Side Gangers <ul style="list-style-type: none"> • For use with high-back models only, where configuration requires a back of a unit to gang to a side of another unit. • Not for use for high-back model lineal/side-to-side ganging. • Ships as a kit; one ganging kit to be specified for each lounge-to-lounge connection. 	MPHB2SDGANG		0.0#	\$ 83

A

HOW TO ORDER

- Indicate the following information on order form:
1. Quantity of each item.
 2. Model number, including options. See "How To Build a Model Number".
 3. Any special service required.

- Note:
- The indicates that a choice is required.
 - The absence of the indicates that no choice is required.
 - Alpha-numeric characters in place of indicate that no other alternatives are available.

HOW TO BUILD A MODEL NUMBER

- A** Select basic model.

SPECIAL SERVICES

Special Carton Marking

With specially marked information N/C

Shipping

Ships **assembled, FOB High Point, NC 27263, freight prepaid.** Freight class 250.

Specifications and prices are subject to change without prior notice.

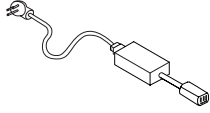
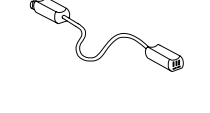

MODEL	Features	MODEL NUMBER		Approx. Packaged Weight	Delivered Pricing
		Basic Model			
 MPM	Byrne Interlink® IQ Infeed Unit <ul style="list-style-type: none"> For use with multi-unit power and Byrne Interlink® IQ power modules Power up to 8 locations with one single circuit infeed unit 10' cord 	INLINKFEED		0.0#	\$ 417
 MPM	Byrne Interlink® IQ Jumper <ul style="list-style-type: none"> For use with multi-unit power and Byrne Interlink® IQ power modules Allows for additional electrical reach through lounge units Jumper cords are considered one "unit" of the 8 maximum units powered by one infeed 	INLINKJUMP		0.0#	\$ 124
MPM	MyPlace 18" Round and Hexagon Active Base Kit	Active Base Kit	MPABOKIT	0.0#	\$ 202

A

HOW TO ORDER

- Indicate the following information on order form:
- Quantity of each item.
 - Model number, including options. See "How To Build a Model Number".
 - Any special service required.

- Note:
- The indicates that a choice is required.
 - The absence of the indicates that no choice is required.
 - Alpha-numeric characters in place of indicate that no other alternatives are available.

HOW TO BUILD A MODEL NUMBER

- A** Select basic model.

SPECIAL SERVICES

Special Carton Marking

With specially marked information N/C

Shipping

Ships **assembled, FOB High Point, NC 27263, freight prepaid.** Freight class 250.

Specifications and prices are subject to change without prior notice.



**C-Table Personal Worksurface
(27" Fixed Height)**

Dimensions

Base diameter	15-1/2"
Tabletop diameter	18"
Overall height	27"

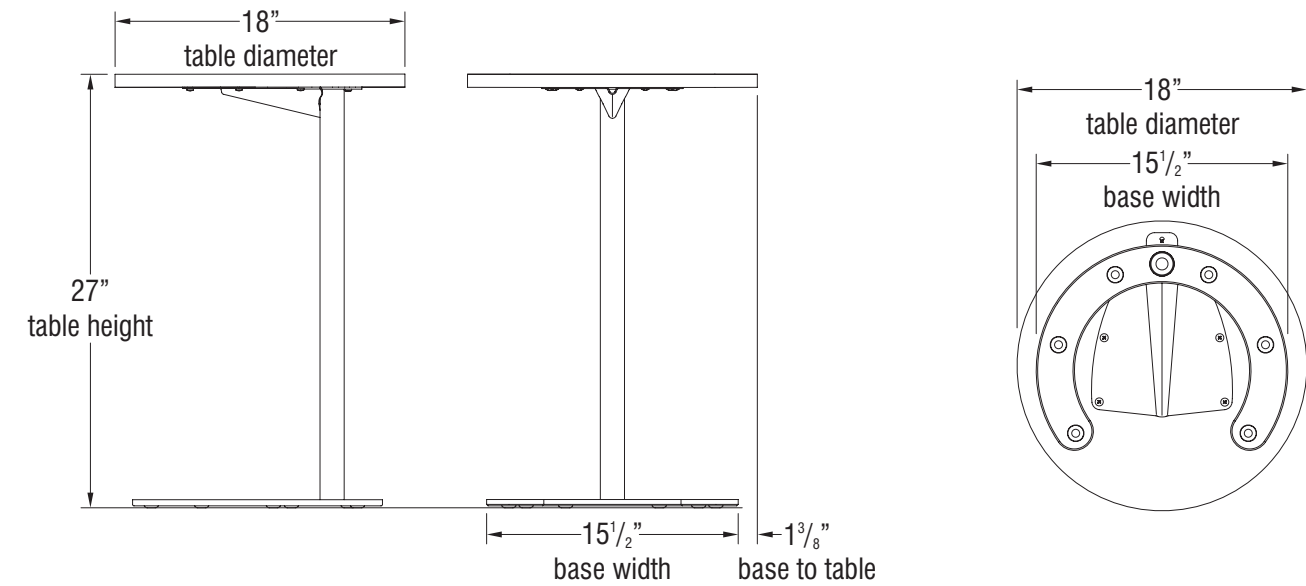
DIMENSIONS

Tabletop

Tabletops are 18" diameter and consist of $\frac{3}{4}$ " thick high-density 45 lb particleboard core with a .03" thick high-pressure laminate top and a .028" thick phenolic backer (bottom). The table edge is 2 mm polypropylene (73P) and is available in a variety of colors. See KI Color Addendum for laminate and edge finish options.

Base Frame

The table base frame is constructed of welded steel. The spider plate is 14-gauge, base is $\frac{3}{8}$ " thick and the vertical post is $1\frac{1}{2}$ " diameter by .083" thick wall. The base frame is finished in electrostatically applied hybrid powdercoating. The coating is then fused and cured in a baking oven to form a smooth, continuous finish that is chemical-resistant, hard, tough and mar-resistant. Powder-coated paint is available in all standard KI paint colors except for chrome. See KI Color Addendum for complete options.

Glides

Six 1" diameter self-adhesive white polyurethane glides are recessed into machined pockets within the steel base.

Table Assembly

Tabletops are attached to the base frame using seven #12 x $\frac{3}{4}$ " Phillips truss head screws. Tables are shipped completely assembled with a packaged weight of 23 lbs. Assembled tables without packaging weigh $17\frac{1}{2}$ " lbs.

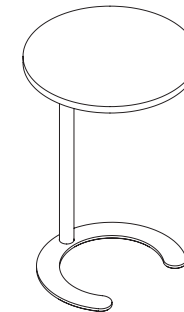
STATEMENT OF LINE

CTBL



**C-Table Max -
Small Rectangle Top
(26" Fixed height or
29" Fixed height)**



**C-Table Max -
Large Rectangle Top
(26" Fixed height or
29" Fixed height)**



**C-Table Max -
Small Rectangle with Curve Top
(26" Fixed height or
29" Fixed height)**



**C-Table Max -
Large Rectangle with Curve Top
(26" Fixed height or
29" Fixed height)**

Dimensions				
Base diameter	19 - 3/4"	19 - 3/4"	19 - 3/4"	19 - 3/4"
Base depth	16 - 3/8"	16 - 3/8"	16 - 3/8"	16 - 3/8"
Tabletop width	26"	30"	26"	30"
Tabletop depth	20"	24"	20"	24"
Overall height	26" / 29"	26" / 29"	26" / 29"	26" / 29"



**C-Table Max -
Small Rectangle Top
(25" - 30" Adjustable Height)**



**C-Table Max -
Large Rectangle Top
(25" - 30" Adjustable Height)**



**C-Table Max -
Small Rectangle with Curve Top
(25" - 30" Adjustable Height)**



**C-Table Max -
Large Rectangle with Curve Top
(25" - 30" Adjustable Height)**

Dimensions				
Base diameter	19 - 3/4"	19 - 3/4"	19 - 3/4"	19 - 3/4"
Base depth	16 - 3/8"	16 - 3/8"	16 - 3/8"	16 - 3/8"
Tabletop width	26"	30"	26"	30"
Tabletop depth	20"	24"	20"	24"
Overall height	25" - 30"	25" - 30"	25" - 30"	25" - 30"



**C-Table Max -
Round Top
(26" Fixed height or
29" Fixed height)**



**C-Table Max -
Round with Curved Top
(26" Fixed height or
29" Fixed height)**



**C-Table Max -
Square Top
(26" Fixed height or
29" Fixed height)**

Dimensions		
Base diameter	19 - 3/4"	19 - 3/4"
Base depth	16 - 3/8"	16 - 3/8"
Tabletop diameter	24"	24"
Tabletop width	26"	
Tabletop depth	19 - 4/5"	26"
Overall height	26" / 29"	26" / 29"



**C-Table Max -
Round Top
(25" - 30"
Adjustable Height)**



**C-Table Max -
Round with Curve Top
(25" - 30"
Adjustable Height)**



**C-Table Max -
Square Top
(25" - 30"
Adjustable Height)**

Dimensions		
Base diameter	19 - 3/4"	19 - 3/4"
Base depth	16 - 3/8"	16 - 3/8"
Tabletop diameter	24"	24"
Tabletop width	26"	
Tabletop depth	19 - 4/5"	26"
Overall height	25" - 30"	25" - 30"

TECHNICAL SPECIFICATIONS

Fixed-Height Table - Dual-Post Cantilever

The fixed-height table is offered in 26" or 29" tabletop heights. The base frame is constructed of welded 1½" diameter, 16-gauge steel tubing with a top mounting plate of 7-gauge (.179" thick) steel and a ¾" (10 mm) thick C-shaped steel base. A ½" diameter welded steel cross brace member stabilizes the entire frame.

Adjustable-Height Table - Dual-Post Cantilever

The adjustable-height table raises and lowers in 1" locking increments, between 25" and 30" overall table height. Adjustability is controlled by a lever assembly that protrudes from the base, underneath the tabletop. When compressed, the lever assembly unlocks the upper frame weldment from the lower frame weldment, allowing height adjustment that is assisted by a pneumatic cylinder enclosed within one of the vertical leg tubes. When the tabletop is positioned at the desired height, the lever can be released, and the bottom of the lever assembly locks into one of six height positioning holes in one of the lower leg tubes. Delrin bushings are installed between the tubes of the upper and lower frames, allowing for smooth adjustment. The outer portion of the lever assembly ships loose and is secured to the inner portion of the lever with a hex jam nut during assembly of the table units.

The upper frame of the adjustable-height table is constructed with two 1¼" diameter, 14-gauge steel tubes and a 7-gauge (.179" thick) steel mounting plate, all welded together. The lower frame of the adjustable-height table is constructed with two 1½" diameter, 16-gauge steel tubes, a 7-gauge (.179") steel mounting plate, and a ¾" (10 mm) thick C-shaped steel base, all welded together. The height adjustment lever is 5/16" diameter welded steel. A ½" diameter welded steel cross brace member stabilizes the entire frame.

Base Finish

Base frames are powder-coat painted, and may be specified in all standard KI colors. Chrome-plated finish is not available. See KI Color Addendum for color options offered.

Table Surfaces

Table surfaces are ¾" thick high-density 45 lb particle board core with .03" thick high pressure laminate and .028" thick phenolic backer (bottom). The table edge is 2 mm polypropylene (73P) and is available in a variety of colors. See KI Color Addendum for laminate and edge finish options.

Glides

Seven 1" diameter self-adhesive white polyurethane glides are recessed into machined pockets within the steel base.

Table Assembly

The tabletop is secured to the base using seven #12 x ¾" Phillips truss head screws. All tabletops are shipped separately from bases.

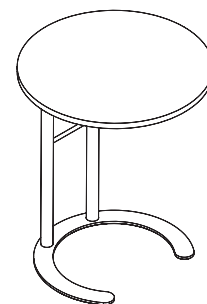

Round Table
CMDGB24 (26" Fixed-Height)
CMDAB24 (29" Fixed-Height)
CMDEB24 (Adjustable-Height)

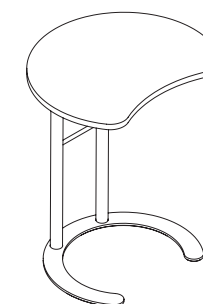

Round Table with Comfort Curve
CMDGP24 (26" Fixed-Height)
CMDAP24 (29" Fixed-Height)
CMDEP24 (Adjustable-Height)

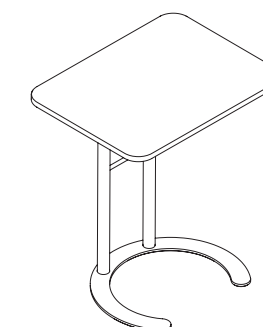

20" x 26" Rectangular Table
CMDGA2026 (26" Fixed-Height)
CMDAA2026 (29" Fixed-Height)
CMDEA2026 (Adjustable-Height)

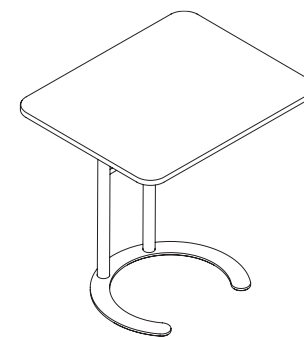

24" x 30" Rectangular Table
CMDGA2430 (26" Fixed-Height)
CMDAA2430 (29" Fixed-Height)
CMDEA2430 (Adjustable-Height)

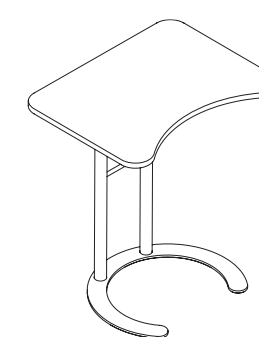

20" x 26" Rectangular Table
with Comfort Curve
CMDGN2026 (26" Fixed-Height)
CMDAN2026 (29" Fixed-Height)
CMDEN2026 (Adjustable-Height)

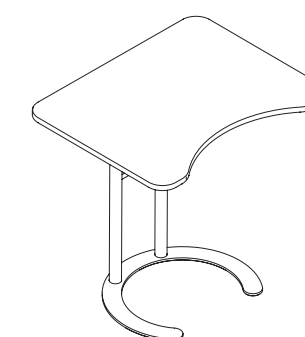

24" x 30" Rectangular Table
with Comfort Curve
CMDGN2430 (26" Fixed-Height)
CMDAN2430 (29" Fixed-Height)
CMDEN2430 (Adjustable-Height)

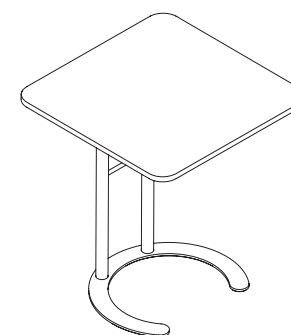

Square Table
CMDGC26 (26" Fixed-Height)
CMDAC26 (29" Fixed-Height)
CMDEC26 (Adjustable-Height)



C-Table Max - Tabletops

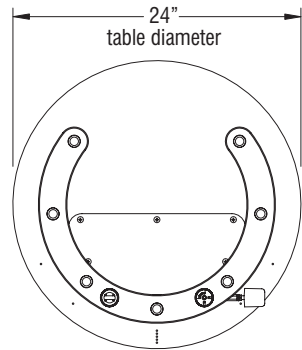

Round Table
CMDGB24 (26" Fixed-Height)
CMDAB24 (29" Fixed-Height)
CMDEB24 (Adjustable-Height)

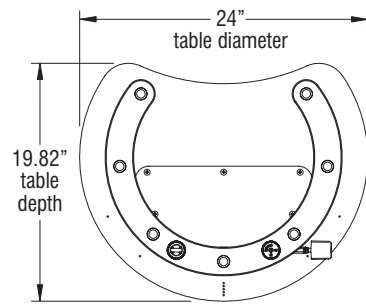

Round Table with Comfort Curve
CMDGP24 (26" Fixed-Height)
CMDAP24 (29" Fixed-Height)
CMDEP24 (Adjustable-Height)

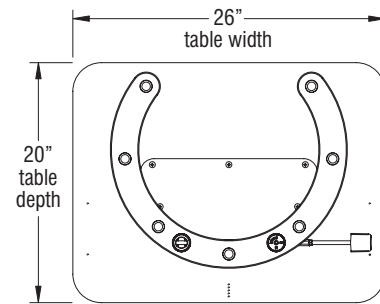

20" x 26" Rectangular Table
CMDGA2026 (26" Fixed-Height)
CMDAA2026 (29" Fixed-Height)
CMDEA2026 (Adjustable-Height)

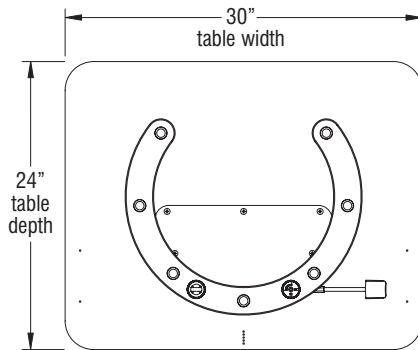

24" x 30" Rectangular Table
CMDGA2430 (26" Fixed-Height)
CMDAA2430 (29" Fixed-Height)
CMDEA2430 (Adjustable-Height)

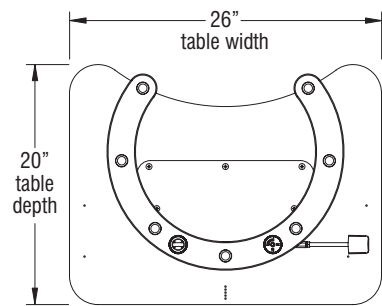

20" x 26" Rectangular Table with Comfort Curve
CMDGN2026 (26" Fixed-Height)
CMDAN2026 (29" Fixed-Height)
CMDEN2026 (Adjustable-Height)

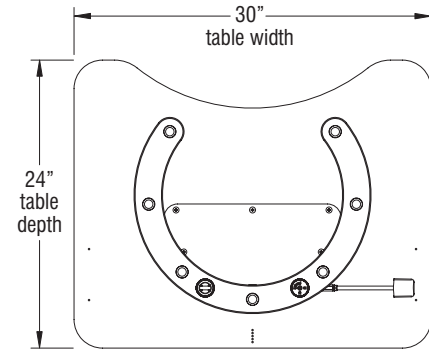

24" x 30" Rectangular Table with Comfort Curve
CMDGN2430 (26" Fixed-Height)
CMDAN2430 (29" Fixed-Height)
CMDEN2430 (Adjustable-Height)

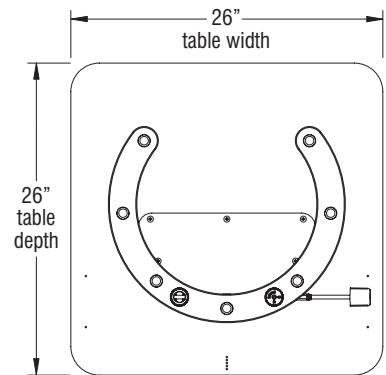

Square Table
CMDGC26 (26" Fixed-Height)
CMDAC26 (29" Fixed-Height)
CMDEC26 (Adjustable-Height)

2
t:
d:

C-Table Max - 26" Fixed-Height Table

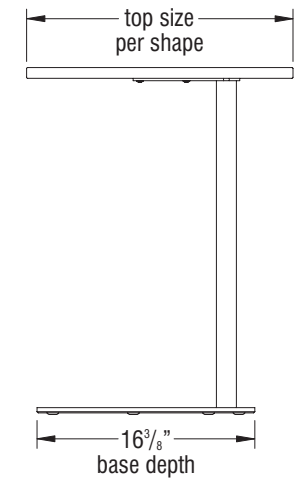
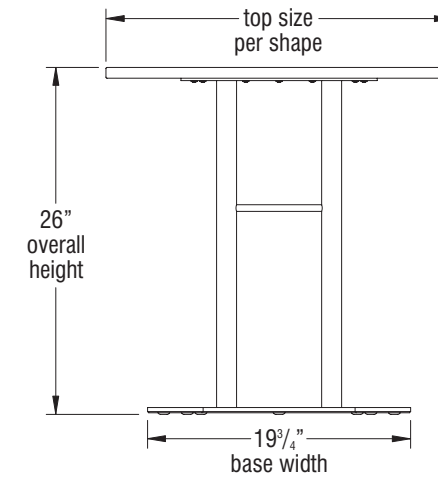

C-Table Max - 29" Fixed-Height Table

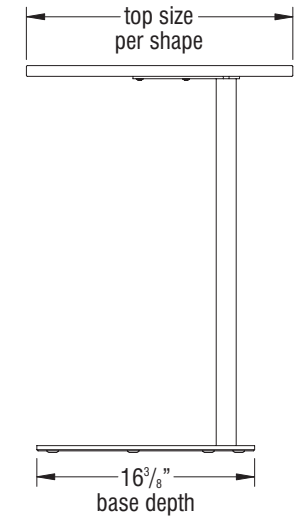
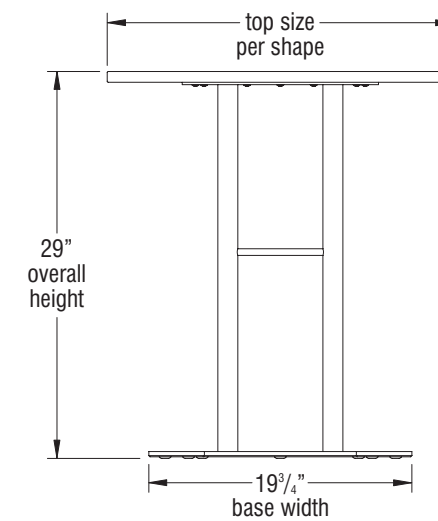

C-Table Max - Adjustable-Height Table

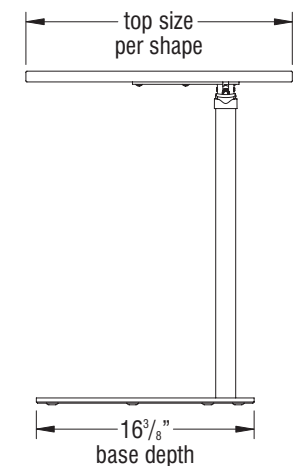
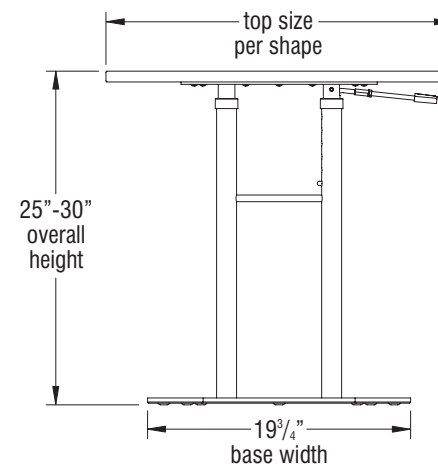



Base Finish		Hartley Walnut	EHW	Pinnacle Walnut	LPW
Black	BL	Hazy Jade	EHJ	River Cherry	LRY
Blue Grey	GR	Italian Silver Ash	EIT	Shadow Zephyr	LSR
Bronze Metallic	ZM	Kensington Maple	EKM	Sterling Ash	LAZ
Cayenne	CY	Light Tone	ELG	Titanium Evolv	LTV
Champagne Metallic	CM	Mardi Gras	EMG	White Nebula	LWL
Cool Grey	CG	Misty Brown	EMY	White Sand	LWN
Cottonwood	CO	Monticello Maple	EMT	Windsor Mahogany	LWY
Earthen Clay	EY	Multiplex	EMB		
Espresso Metallic	EX	Nemo	ENE	Surface Finish--Grade 2 Standard Laminate	
Everglade Shade	EV	Nordic	END	Akira	LAK
Flannel	FN	Pinnacle Walnut	EPW	Black Alicante	LBV
Glitz Metallic	GZ	Poppy Red	EPR	Black Hills Oak	LBH
Hazy Jade	HJ	Rainforest	ERQ	Calcutta Marble	LCQ
Honey Bee	HY	Raleigh Walnut	ERW	Dering Forest	LDF
Light Tone	LG	River Cherry	ERY	Fawn Cypress	LFQ
Mardi Gras	MG	Rubber Ducky	ERK	Ice Mist	LIM
Misty Brown	MY	Sand	ESA	Markerboard White	LMK
Nemo	NE	Sky Blue	ESK	Valley Forge Elm	LVF
Nordic	ND	Solano Walnut	ESG	White River Forest	LWR
Poppy Red	PR	Sterling Ash	EAZ	Surface Finish--Grade 3 Standard Laminate	
Purple Haze	PH	Surf's Up	ESP	Black Velvet	LBV
Rainforest	RQ	Tarragon	ETQ	Cumberland Walnut	LCJ
Raw Jasper	RJ	Twilight Shadow	ETI	Designer White Velvet	LDE
Rubber Ducky	RK	Ultra Blue	EUB	Hartley Walnut	LHW
Sand	SA	Valley Forge Elm	EVF	Nile Velvet	LNL
Sky Blue	SK	Warm Grey	EWG	Raleigh Walnut	LRW
Starlight Silver Metallic	SX	White River Forest	EWR	Solano Walnut	LSG
Surf's Up	SP	Windsor Mahogany	EWY	Spruce Velvet	LSC
Tarragon	TQ	Zesty Lime	EZL		
Twilight Shadow	TI				
Ultra Blue	UB	Surface Finish--Grade 1 Standard Laminate			
Warm Grey	WG	Beigewood	LBZ		
Zesty Lime	ZL	Belair	LBQ		
		Biltmore Cherry	LBT		
		Black	LBK		
Edge Style for 73P Edge		Brighton Walnut	LBW		
Akira	EAK	Castle Oak	LCO		
Beigewood	EBZ	Cherry Storm	LCX		
Belair	EBQ	Classic Linen	LCI		
Biltmore Cherry	EBT	Cocobala	LCC		
Black	EBL	Crisp Linen	LRI		
Black Hills Oak	EBH	Designer White	LDR		
Blue Grey	EGR	Dove Grey	LDG		
Brighton Walnut	EBW	Florence Walnut	LFC		
Castle Oak	ECO	Friston Ash	LFH		
Cayenne	ECY	Frosty White	LFW		
Cherry Storm	ECX	Graphite Nebula	LGN		
Cocobala	ECC	Grey	LGE		
Cool Grey	ECG	High Rise	LHE		
Cumberland Walnut	ECJ	Hollyberry	LHY		
Dering Forest	EDF	Island	LID		
Designer White	EDR	Italian Silver Ash	LIT		
Everglade Shade	EEV	Kensington Maple	LKM		
Fawn Cypress	EFQ	Lapis Blue	LLB		
Flannel	EFN	Monticello Maple	LMT		
Florence Walnut	EFC	North Sea	LNA		
Friston Ash	EFH	Ocean	LON		
Frosty White	EFW				

Finish Cards

View color swatches for items listed within this document.

Paints**Plastics/Poly****Wood/Veneer****Laminates****Molded Edges****Edge Styles****Hard Plastics****Glass**

Certain options referenced may not be available on GSA Schedule.

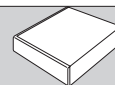

3/4" 73P
Edge
(73P)

\$ 618

Laminate
Grade 2
add to list
price

\$ 19

Laminate
Grade 3
add to list
price

\$ 120

MODEL	Features	MODEL NUMBER					Approx. Packaged Weight	Laminate Grade 2 add to list price	Laminate Grade 3 add to list price
		Basic Model	Edge Style	Edge Color	Surface Finish	Base Finish			
CTBL	C-Table, Personal Worksurface • C-Table features single column base • 18" diameter round worksurface • Fixed height only • Recommended for use with soft seating elements. 27" height allows for this product to be stored under standard 29" work surfaces. • Ships fully assembled	27" High	CTABLE	73P	<input type="checkbox"/> <input type="checkbox"/> <input type="checkbox"/>	<input type="checkbox"/> <input type="checkbox"/> <input type="checkbox"/>	<input type="checkbox"/> <input type="checkbox"/>	23.0#	
				A	B	C	D	E	

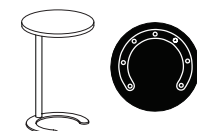

CTBL

HOW TO ORDER

- Indicate the following information on order form:
- Quantity of each item.
 - Model number, including options. See "How To Build a Model Number".
 - Any special service required.

Note:

- The indicates that a choice is required.
- The absence of the indicates that no choice is required.
- Alpha-numeric characters in place of indicate that no other alternatives are available.

HOW TO BUILD A MODEL NUMBER

- A** Select basic model.
- B** Select edge style.
73P - 3/4" 73P edge
- C** Select edge color.
Refer to the **Product Color Options** page in this price list.
- D** Select surface finish.
Refer to the **Product Color Options** page in this price list.
- E** Select base finish.
Refer to the **Product Color Options** page in this price list.

FINISH INFORMATION

ADDITIONAL LAMINATE OFFERING

KI offers laminates beyond those offered in the standard offering. Laminates that are currently available in the program can be viewed in KI product specification tools. Requests to add laminates to the program can be submitted via the product modification request process. Please note, requests to add laminates to the program must include the laminate manufacturers name, color/pattern number, and finish code. Edge options are limited to standard edge colors. If a matching edge is required, this will need to be requested thru the product modification request process and may be subject to additional costs. Due to varying manufacturing processes and quality issues with some laminates, some requests may be denied. Extended lead times and minimum order quantities may apply on orders containing special laminates. Contact the product modification team for questions or additional information regarding special laminates and pricing.

SPECIAL SERVICES

Special Carton Marking







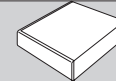

With specially marked information N/C

Shipping
Ships **assembled, FOB Bondue1, WI 54107, freight prepaid.** Freight class 125.

Specifications and prices are subject to change without prior notice.



3/4" 73P
Edge
(73P)

MODEL	Features	MODEL NUMBER					Approx. Packaged Weight	3/4" 73P Edge (73P)	Laminate Grade 2 add to list price	Laminate Grade 3 add to list price
		Basic Model	Edge Style	Edge Color	Surface Finish	Base Finish				
  CMDGA	Fixed Height - Small Rectangle Top • C-Table Max features a two column base • 20" x 26" worksurface • Generally recommended for use with seating that have seat heights less than 17.5" and/or seating which has significant seat pitch. • Top and base ships in separate packaging; limited assembly required	26" High	CMDGA2026	73P	<input type="checkbox"/> <input type="checkbox"/>	<input type="checkbox"/> <input type="checkbox"/>	<input type="checkbox"/>	40.0#	\$ 677	\$ 19 \$ 120
  CMDGA	Fixed Height - Large Rectangle Top • C-Table Max features a two column base • 24" x 30" worksurface • Generally recommended for use with seating that have seat heights less than 17.5" and/or seating which has significant seat pitch. • Top and base ships in separate packaging; limited assembly required	26" High	CMDGA2430	73P	<input type="checkbox"/> <input type="checkbox"/>	<input type="checkbox"/> <input type="checkbox"/>	<input type="checkbox"/>	47.0#	\$ 677	\$ 19 \$ 120
  CMDGN	Fixed Height - Small Rectangle with Curve Top • C-Table Max features a two column base • 20" x 26" worksurface • Generally recommended for use with seating that have seat heights less than 17.5" and/or seating which has significant seat pitch. • Top and base ships in separate packaging; limited assembly required	26" High	CMDGN2026	73P	<input type="checkbox"/> <input type="checkbox"/>	<input type="checkbox"/> <input type="checkbox"/>	<input type="checkbox"/>	38.0#	\$ 677	\$ 19 \$ 120
  CMDGN	Fixed Height - Large Rectangle with Curve Top • C-Table Max features a two column base • 24" x 30" worksurface • Generally recommended for use with seating that have seat heights less than 17.5" and/or seating which has significant seat pitch. • Top and base ships in separate packaging; limited assembly required	26" High	CMDGN2430	73P	<input type="checkbox"/> <input type="checkbox"/>	<input type="checkbox"/> <input type="checkbox"/>	<input type="checkbox"/>	45.0#	\$ 677	\$ 19 \$ 120

A **B** **C** **D** **E**

HOW TO ORDER

- Indicate the following information on order form:
- Quantity of each item.
 - Model number, including options. See "How To Build a Model Number".
 - Any special service required.

Note: • The indicates that a choice is required.
 • The absence of the indicates that no choice is required.
 • Alpha-numeric characters in place of indicate that no other alternatives are available.

HOW TO BUILD A MODEL NUMBER

- A** Select basic model.
- B** Select edge style.
73P - 3/4" 73P edge
- C** Select edge color.
Refer to the **Product Color Options** page in this price list.
- D** Select surface finish.
Refer to the **Product Color Options** page in this price list.
- E** Select base finish.
Refer to the **Product Color Options** page in this price list.

FINISH INFORMATION

ADDITIONAL LAMINATE OFFERING

KI offers laminates beyond those offered in the standard offering. Laminates that are currently available in the program can be viewed in KI product specification tools. Requests to add laminates to the program can be submitted via the product modification request process. Please note, requests to add laminates to the program must include the laminate manufacturers name, color/pattern number, and finish code. Edge options are limited to standard edge colors. If a matching edge is required, this will need to be requested thru the product modification request process and may be subject to additional costs. Due to varying manufacturing processes and quality issues with some laminates, some requests may be denied. Extended lead times and minimum order quantities may apply on orders containing special laminates. Contact the product modification team for questions or additional information regarding special laminates and pricing.

SPECIAL SERVICES

Special Carton Marking

With specially marked information N/C

Shipping
 Ships **knocked down, FOB Bonduel, WI 54107, freight prepaid.** Freight class 125.

Specifications and prices are subject to change without prior notice.

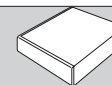

3/4" 73P
Edge
(73P)

\$ 677

Laminate
Grade 2
add to list
price

Laminate
Grade 3
add to list
price

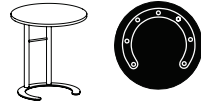
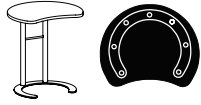
MODEL	Features	MODEL NUMBER					Approx. Packaged Weight	3/4" 73P Edge (73P)	Laminate Grade 2 add to list price	Laminate Grade 3 add to list price	
		Basic Model	Edge Style	Edge Color	Surface Finish	Base Finish					
 CMDGB	Fixed Height - Round Top • C-Table Max features a two column base • 24" round worksurface • Generally recommended for use with seating that have seat heights less than 17.5" and/or seating which has significant seat pitch. • Top and base ships in separate packaging; limited assembly required	26" High	CMDGB24	73P	<input type="checkbox"/>	<input type="checkbox"/>	<input type="checkbox"/>	38.0#	\$ 677	\$ 19	\$ 120
 CMDGP	Fixed Height - Round with Curve Top • C-Table Max features a two column base • 24" round worksurface • Generally recommended for use with seating that have seat heights less than 17.5" and/or seating which has significant seat pitch. • Top and base ships in separate packaging; limited assembly required	26" High	CMDGP24	73P	<input type="checkbox"/>	<input type="checkbox"/>	<input type="checkbox"/>	35.0#	\$ 677	\$ 19	\$ 120

A **B** **C** **D** **E**

HOW TO ORDER

- Indicate the following information on order form:
- Quantity of each item.
 - Model number, including options. See "How To Build a Model Number".
 - Any special service required.

Note: • The indicates that a choice is required.
 • The absence of the indicates that no choice is required.
 • Alpha-numeric characters in place of indicate that no other alternatives are available.

HOW TO BUILD A MODEL NUMBER

- A** Select basic model.
- B** Select edge style.
73P - 3/4" 73P edge
- C** Select edge color.
Refer to the **Product Color Options** page in this price list.
- D** Select surface finish.
Refer to the **Product Color Options** page in this price list.
- E** Select base finish.
Refer to the **Product Color Options** page in this price list.

FINISH INFORMATION

ADDITIONAL LAMINATE OFFERING

KI offers laminates beyond those offered in the standard offering. Laminates that are currently available in the program can be viewed in KI product specification tools. Requests to add laminates to the program can be submitted via the product modification request process. Please note, requests to add laminates to the program must include the laminate manufacturers name, color/pattern number, and finish code. Edge options are limited to standard edge colors. If a matching edge is required, this will need to be requested thru the product modification request process and may be subject to additional costs. Due to varying manufacturing processes and quality issues with some laminates, some requests may be denied. Extended lead times and minimum order quantities may apply on orders containing special laminates. Contact the product modification team for questions or additional information regarding special laminates and pricing.

SPECIAL SERVICES

Special Carton Marking

With specially marked information N/C

Shipping

Ships **knocked down, FOB Bonduel, WI 54107, freight prepaid.** Freight class 125.

Specifications and prices are subject to change without prior notice.

C-Table™ Max

26" Fixed Height

C-Table™ Max

26" Fixed Height

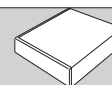

3/4" 73P
Edge
(73P)

\$ 677

Laminate
Grade 2
add to list
price

\$ 27

Laminate
Grade 3
add to list
price

\$ 178

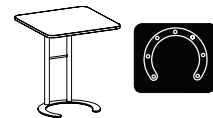

CMDGC

MODEL

Features

- Fixed Height - Square Top**
- C-Table Max features a two column base
 - 26" square worksurface
 - Generally recommended for use with seating that have seat heights less than 17.5" and/or seating which has significant seat pitch.
 - Top and base ships in separate packaging; limited assembly required

26" High

MODEL NUMBER				
Basic Model	Edge Style	Edge Color	Surface Finish	Base Finish
CMDGC26	73P	<input type="checkbox"/> <input type="checkbox"/> <input type="checkbox"/>	<input type="checkbox"/> <input type="checkbox"/> <input type="checkbox"/>	<input type="checkbox"/> <input type="checkbox"/>

Approx.
Packaged
Weight

45.0#

A **B** **C** **D** **E**

HOW TO ORDER

- Indicate the following information on order form:
1. Quantity of each item.
 2. Model number, including options. See "How To Build a Model Number".
 3. Any special service required.

Note:

- The indicates that a choice is required.
- The absence of the indicates that no choice is required.
- Alpha-numeric characters in place of indicate that no other alternatives are available.

HOW TO BUILD A MODEL NUMBER

- A** Select basic model.
- B** Select edge style.
73P - 3/4" 73P edge
- C** Select edge color.
Refer to the **Product Color Options** page in this price list.
- D** Select surface finish.
Refer to the **Product Color Options** page in this price list.
- E** Select base finish.
Refer to the **Product Color Options** page in this price list.

FINISH INFORMATION

ADDITIONAL LAMINATE OFFERING

KI offers laminates beyond those offered in the standard offering. Laminates that are currently available in the program can be viewed in KI product specification tools. Requests to add laminates to the program can be submitted via the product modification request process. Please note, requests to add laminates to the program must include the laminate manufacturers name, color/pattern number, and finish code. Edge options are limited to standard edge colors. If a matching edge is required, this will need to be requested thru the product modification request process and may be subject to additional costs. Due to varying manufacturing processes and quality issues with some laminates, some requests may be denied. Extended lead times and minimum order quantities may apply on orders containing special laminates. Contact the product modification team for questions or additional information regarding special laminates and pricing.

SPECIAL SERVICES

Special Carton Marking

With specially marked information N/C

Shipping
Ships **knocked down, FOB Bonduel, WI 54107, freight prepaid.** Freight class 125.

Specifications and prices are subject to change without prior notice.

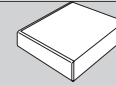



3/4" 73P
Edge
(73P)

\$ 677

Laminate
Grade 2
add to list
price

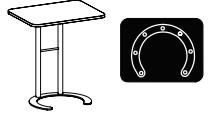
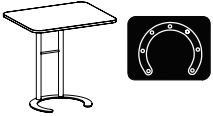
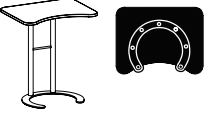
Laminate
Grade 3
add to list
price

MODEL	Features	MODEL NUMBER					Approx. Packaged Weight			Laminate Grade 2 add to list price	Laminate Grade 3 add to list price
		Basic Model	Edge Style	Edge Color	Surface Finish	Base Finish					
 CMDAA	Fixed Height - Small Rectangle Top • C-Table Max features a two column base • 20" x 26" worksurface • Generally recommended for use with seating that have seat heights higher than 17.5" and/or seating which has no significant seat pitch • Top and base ships in separate packaging; limited assembly required	29" High	CMDAA2026	73P	<input type="checkbox"/>	<input type="checkbox"/>	<input type="checkbox"/>	40.0#	\$ 677	\$ 19	\$ 120
 CMDAA	Fixed Height - Large Rectangle Top • C-Table Max features a two column base • 24" x 30" worksurface • Generally recommended for use with seating that have seat heights higher than 17.5" and/or seating which has no significant seat pitch • Top and base ships in separate packaging; limited assembly required	29" High	CMDAA2430	73P	<input type="checkbox"/>	<input type="checkbox"/>	<input type="checkbox"/>	47.0#	\$ 677	\$ 19	\$ 120
 CMDAN	Fixed Height - Small Rectangle with Curve Top • C-Table Max features a two column base • 20" x 26" worksurface • Generally recommended for use with seating that have seat heights higher than 17.5" and/or seating which has no significant seat pitch • Top and base ships in separate packaging; limited assembly required	29" High	CMDAN2026	73P	<input type="checkbox"/>	<input type="checkbox"/>	<input type="checkbox"/>	39.0#	\$ 677	\$ 19	\$ 120
 CMDAN	Fixed Height - Large Rectangle with Curve Top • C-Table Max features a two column base • 24" x 30" worksurface • Generally recommended for use with seating that have seat heights higher than 17.5" and/or seating which has no significant seat pitch • Top and base ships in separate packaging; limited assembly required	29" High	CMDAN2430	73P	<input type="checkbox"/>	<input type="checkbox"/>	<input type="checkbox"/>	45.0#	\$ 677	\$ 19	\$ 120

A **B** **C** **D** **E**

HOW TO ORDER

- Indicate the following information on order form:
- Quantity of each item.
 - Model number, including options. See "How To Build a Model Number".
 - Any special service required.

Note: • The indicates that a choice is required.
 • The absence of the indicates that no choice is required.
 • Alpha-numeric characters in place of indicate that no other alternatives are available.

HOW TO BUILD A MODEL NUMBER

- A** Select basic model.
- B** Select edge style.
73P - 3/4" 73P edge
- C** Select edge color.
Refer to the **Product Color Options** page in this price list.
- D** Select surface finish.
Refer to the **Product Color Options** page in this price list.
- E** Select base finish.
Refer to the **Product Color Options** page in this price list.

FINISH INFORMATION

ADDITIONAL LAMINATE OFFERING

KI offers laminates beyond those offered in the standard offering. Laminates that are currently available in the program can be viewed in KI product specification tools. Requests to add laminates to the program can be submitted via the product modification request process. Please note, requests to add laminates to the program must include the laminate manufacturers name, color/pattern number, and finish code. Edge options are limited to standard edge colors. If a matching edge is required, this will need to be requested thru the product modification request process and may be subject to additional costs. Due to varying manufacturing processes and quality issues with some laminates, some requests may be denied. Extended lead times and minimum order quantities may apply on orders containing special laminates. Contact the product modification team for questions or additional information regarding special laminates and pricing.

SPECIAL SERVICES

Special Carton Marking

With specially marked information N/C

Shipping
 Ships **knocked down, FOB Bonduel, WI 54107, freight prepaid.** Freight class 125.

Specifications and prices are subject to change without prior notice.

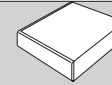

3/4" 73P
Edge
(73P)

\$ 677

Laminate
Grade 2
add to list
price

\$ 19

Laminate
Grade 3
add to list
price

\$ 120

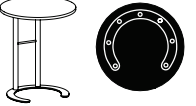
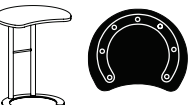
MODEL	Features	MODEL NUMBER					Approx. Packaged Weight	3/4" 73P Edge (73P)	Laminate Grade 2 add to list price	Laminate Grade 3 add to list price	
		Basic Model	Edge Style	Edge Color	Surface Finish	Base Finish					
 CMDAB	Fixed Height - Round Top • C-Table Max features a two column base • 24" round worksurface • Generally recommended for use with seating that have seat heights higher than 17.5" and/or seating which has no significant seat pitch • Top and base ships in separate packaging; limited assembly required	29" High	CMDAB24	73P	<input type="checkbox"/>	<input type="checkbox"/>	<input type="checkbox"/>	38.0#	\$ 677	\$ 19	\$ 120
 CMDAP	Fixed Height - Round with Curve Top • C-Table Max features a two column base • 24" round worksurface • Generally recommended for use with seating that have seat heights higher than 17.5" and/or seating which has no significant seat pitch • Top and base ships in separate packaging; limited assembly required	29" High	CMDAP24	73P	<input type="checkbox"/>	<input type="checkbox"/>	<input type="checkbox"/>	35.0#	\$ 677	\$ 19	\$ 120

A **B** **C** **D** **E**

HOW TO ORDER

- Indicate the following information on order form:
- Quantity of each item.
 - Model number, including options. See "How To Build a Model Number".
 - Any special service required.

Note: • The indicates that a choice is required.
 • The absence of the indicates that no choice is required.
 • Alpha-numeric characters in place of indicate that no other alternatives are available.

HOW TO BUILD A MODEL NUMBER

- A** Select basic model.
- B** Select edge style.
73P - 3/4" 73P edge
- C** Select edge color.
Refer to the **Product Color Options** page in this price list.
- D** Select surface finish.
Refer to the **Product Color Options** page in this price list.
- E** Select base finish.
Refer to the **Product Color Options** page in this price list.

FINISH INFORMATION

ADDITIONAL LAMINATE OFFERING

KI offers laminates beyond those offered in the standard offering. Laminates that are currently available in the program can be viewed in KI product specification tools. Requests to add laminates to the program can be submitted via the product modification request process. Please note, requests to add laminates to the program must include the laminate manufacturers name, color/pattern number, and finish code. Edge options are limited to standard edge colors. If a matching edge is required, this will need to be requested thru the product modification request process and may be subject to additional costs. Due to varying manufacturing processes and quality issues with some laminates, some requests may be denied. Extended lead times and minimum order quantities may apply on orders containing special laminates. Contact the product modification team for questions or additional information regarding special laminates and pricing.

SPECIAL SERVICES

Special Carton Marking

With specially marked information N/C

Shipping
Ships **knocked down, FOB Bonduel, WI 54107, freight prepaid.** Freight class 125.

Specifications and prices are subject to change without prior notice.

C-Table™ Max

29" Fixed Height

C-Table™ Max

29" Fixed Height

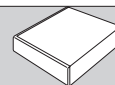

3/4" 73P
Edge
(73P)

\$ 677

Laminate
Grade 2
add to list
price

\$ 27

Laminate
Grade 3
add to list
price

\$ 178



CMDAC



MODEL

Features

- Fixed Height - Square Top**
- C-Table Max features a two column base
 - 26" square worksurface
 - Generally recommended for use with seating that have seat heights higher than 17.5" and/or seating which has no significant seat pitch.
 - Top and base ships in separate packaging; limited assembly required

29" High

MODEL NUMBER				
Basic Model	Edge Style	Edge Color	Surface Finish	Base Finish
CMDAC26	73P	<input type="checkbox"/> <input type="checkbox"/>	<input type="checkbox"/> <input type="checkbox"/>	<input type="checkbox"/> <input type="checkbox"/>

Approx.
Packaged
Weight

46.0#

A **B** **C** **D** **E**

HOW TO ORDER

- Indicate the following information on order form:
1. Quantity of each item.
 2. Model number, including options. See "How To Build a Model Number".
 3. Any special service required.

Note:

- The indicates that a choice is required.
- The absence of the indicates that no choice is required.
- Alpha-numeric characters in place of indicate that no other alternatives are available.

HOW TO BUILD A MODEL NUMBER

- A** Select basic model.
- B** Select edge style.
73P - 3/4" 73P edge
- C** Select edge color.
Refer to the **Product Color Options** page in this price list.
- D** Select surface finish.
Refer to the **Product Color Options** page in this price list.
- E** Select base finish.
Refer to the **Product Color Options** page in this price list.

FINISH INFORMATION

ADDITIONAL LAMINATE OFFERING

KI offers laminates beyond those offered in the standard offering. Laminates that are currently available in the program can be viewed in KI product specification tools. Requests to add laminates to the program can be submitted via the product modification request process. Please note, requests to add laminates to the program must include the laminate manufacturers name, color/pattern number, and finish code. Edge options are limited to standard edge colors. If a matching edge is required, this will need to be requested thru the product modification request process and may be subject to additional costs. Due to varying manufacturing processes and quality issues with some laminates, some requests may be denied. Extended lead times and minimum order quantities may apply on orders containing special laminates. Contact the product modification team for questions or additional information regarding special laminates and pricing.

SPECIAL SERVICES

Special Carton Marking

With specially marked information N/C



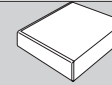

Shipping

Ships **knocked down, FOB Bonduel, WI 54107, freight prepaid.** Freight class 125.

Specifications and prices are subject to change without prior notice.



3/4" 73P
Edge
(73P)

MODEL	Features	MODEL NUMBER					Approx. Packaged Weight	3/4" 73P Edge (73P)	Laminate Grade 2 add to list price	Laminate Grade 3 add to list price
		Basic Model	Edge Style	Edge Color	Surface Finish	Base Finish				
 CMDEA	Adjustable Height - Small Rectangle Top • C-Table Max features a two column base • 20" x 26" worksurface • Lever actuated base height adjustment • Generally recommended for use in environments with varying seat heights and/or varying seat pitch • Top and base ships in separate packaging; limited assembly required	25" - 30" High	CMDEA2026	73P	<input type="checkbox"/>	<input type="checkbox"/>	<input type="checkbox"/>	43.0#	\$ 841	\$ 19 \$ 120
 CMDEA	Adjustable Height - Large Rectangle Top • C-Table Max features a two column base • 24" x 30" worksurface • Lever actuated base height adjustment • Generally recommended for use in environments with varying seat heights and/or varying seat pitch • Top and base ships in separate packaging; limited assembly required	25" - 30" High	CMDEA2430	73P	<input type="checkbox"/>	<input type="checkbox"/>	<input type="checkbox"/>	50.0#	\$ 841	\$ 19 \$ 120
 CMDEN	Adjustable Height - Small Rectangle with Curve Top • C-Table Max features a two column base • 20" x 26" worksurface • Lever actuated base height adjustment • Generally recommended for use in environments with varying seat heights and/or varying seat pitch • Top and base ships in separate packaging; limited assembly required	25" - 30" High	CMDEN2026	73P	<input type="checkbox"/>	<input type="checkbox"/>	<input type="checkbox"/>	42.0#	\$ 841	\$ 19 \$ 120
 CMDEN	Adjustable Height - Large Rectangle with Curve Top • C-Table Max features a two column base • 24" x 30" worksurface • Lever actuated base height adjustment • Generally recommended for use in environments with varying seat heights and/or varying seat pitch • Top and base ships in separate packaging; limited assembly required	25" - 30" High	CMDEN2430	73P	<input type="checkbox"/>	<input type="checkbox"/>	<input type="checkbox"/>	48.0#	\$ 841	\$ 19 \$ 120

A **B** **C** **D** **E**

HOW TO ORDER

- Indicate the following information on order form:
- Quantity of each item.
 - Model number, including options. See "How To Build a Model Number".
 - Any special service required.

Note: • The indicates that a choice is required.
 • The absence of the indicates that no choice is required.
 • Alpha-numeric characters in place of indicate that no other alternatives are available.

HOW TO BUILD A MODEL NUMBER

- A** Select basic model.
- B** Select edge style.
73P - 3/4" 73P edge
- C** Select edge color.
Refer to the **Product Color Options** page in this price list.
- D** Select surface finish.
Refer to the **Product Color Options** page in this price list.
- E** Select base finish.
Refer to the **Product Color Options** page in this price list.

FINISH INFORMATION

ADDITIONAL LAMINATE OFFERING

KI offers laminates beyond those offered in the standard offering. Laminates that are currently available in the program can be viewed in KI product specification tools. Requests to add laminates to the program can be submitted via the product modification request process. Please note, requests to add laminates to the program must include the laminate manufacturers name, color/pattern number, and finish code. Edge options are limited to standard edge colors. If a matching edge is required, this will need to be requested thru the product modification request process and may be subject to additional costs. Due to varying manufacturing processes and quality issues with some laminates, some requests may be denied. Extended lead times and minimum order quantities may apply on orders containing special laminates. Contact the product modification team for questions or additional information regarding special laminates and pricing.

SPECIAL SERVICES

Special Carton Marking

With specially marked information N/C

Shipping

Ships **knocked down, FOB Bonduel, WI 54107, freight prepaid.** Freight class 125.

Specifications and prices are subject to change without prior notice.

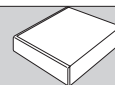

3/4" 73P
Edge
(73P)

\$ 841

Laminate
Grade 2
add to list
price

\$ 19

Laminate
Grade 3
add to list
price

\$ 120

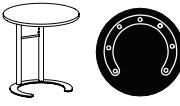
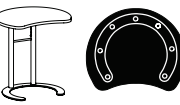
MODEL	Features	MODEL NUMBER					Approx. Packaged Weight	3/4" 73P Edge (73P)	Laminate Grade 2 add to list price	Laminate Grade 3 add to list price
		Basic Model	Edge Style	Edge Color	Surface Finish	Base Finish				
 CMDEB	Adjustable Height - Round Top 25" - 30" High • C-Table Max features a two column base • 24" round worksurface • Lever actuated base height adjustment • Generally recommended for use in environments with varying seat heights and/or varying seat pitch • Top and base ships in separate packaging; limited assembly required	CMDEB24	73P	<input type="checkbox"/> <input type="checkbox"/>	<input type="checkbox"/> <input type="checkbox"/>	<input type="checkbox"/>	41.0#	\$ 841	\$ 19	\$ 120
 CMDEP	Adjustable Height - Round with Curve Top 25" - 30" High • C-Table Max features a two column base • 24" round worksurface • Lever actuated base height adjustment • Generally recommended for use in environments with varying seat heights and/or varying seat pitch • Top and base ships in separate packaging; limited assembly required	CMDEP24	73P	<input type="checkbox"/> <input type="checkbox"/>	<input type="checkbox"/> <input type="checkbox"/>	<input type="checkbox"/>	38.0#	\$ 841	\$ 19	\$ 120
		A	B	C	D	E				

HOW TO ORDER

- Indicate the following information on order form:
- Quantity of each item.
 - Model number, including options. See "How To Build a Model Number".
 - Any special service required.

Note: • The indicates that a choice is required.
 • The absence of the indicates that no choice is required.
 • Alpha-numeric characters in place of indicate that no other alternatives are available.

HOW TO BUILD A MODEL NUMBER

- A** Select basic model.
- B** Select edge style.
73P - 3/4" 73P edge
- C** Select edge color.
Refer to the **Product Color Options** page in this price list.
- D** Select surface finish.
Refer to the **Product Color Options** page in this price list.
- E** Select base finish.
Refer to the **Product Color Options** page in this price list.

FINISH INFORMATION

ADDITIONAL LAMINATE OFFERING

KI offers laminates beyond those offered in the standard offering. Laminates that are currently available in the program can be viewed in KI product specification tools. Requests to add laminates to the program can be submitted via the product modification request process. Please note, requests to add laminates to the program must include the laminate manufacturers name, color/pattern number, and finish code. Edge options are limited to standard edge colors. If a matching edge is required, this will need to be requested thru the product modification request process and may be subject to additional costs. Due to varying manufacturing processes and quality issues with some laminates, some requests may be denied. Extended lead times and minimum order quantities may apply on orders containing special laminates. Contact the product modification team for questions or additional information regarding special laminates and pricing.

SPECIAL SERVICES

Special Carton Marking

With specially marked information N/C

Shipping

Ships **knocked down, FOB Bonduel, WI 54107, freight prepaid**. Freight class 125.

Specifications and prices are subject to change without prior notice.

C-Table™ Max

25" - 30" Adjustable Height

C-Table™ Max

25" - 30" Adjustable Height

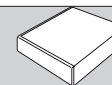

3/4" 73P Edge (73P)

\$ 841

Laminate Grade 2 add to list price

\$ 27

Laminate Grade 3 add to list price

\$ 178

MODEL	Features	MODEL NUMBER					Approx. Packaged Weight	3/4" 73P Edge (73P)	Laminate Grade 2 add to list price	Laminate Grade 3 add to list price	
		Basic Model	Edge Style	Edge Color	Surface Finish	Base Finish					
CMDEC	Adjustable Height - Square Top • C-Table Max features a two column base • 26" square worksurface • Lever actuated base height adjustment • Generally recommended for use in environments with varying seat heights and/or varying seat pitch • Top and base ships in separate packaging; limited assembly required	25" - 30" High	CMDEC26	73P	<input type="checkbox"/> <input type="checkbox"/>	<input type="checkbox"/> <input type="checkbox"/>	<input type="checkbox"/>	49.0#	\$ 841	\$ 27	\$ 178



CMDEC

A **B** **C** **D** **E**

HOW TO ORDER

- Indicate the following information on order form:
- Quantity of each item.
 - Model number, including options. See "How To Build a Model Number".
 - Any special service required.

Note:

- The indicates that a choice is required.
- The absence of the indicates that no choice is required.
- Alpha-numeric characters in place of indicate that no other alternatives are available.

HOW TO BUILD A MODEL NUMBER

- A** Select basic model.
- B** Select edge style.
73P - 3/4" 73P edge
- C** Select edge color.
Refer to the **Product Color Options** page in this price list.
- D** Select surface finish.
Refer to the **Product Color Options** page in this price list.
- E** Select base finish.
Refer to the **Product Color Options** page in this price list.

FINISH INFORMATION

ADDITIONAL LAMINATE OFFERING

KI offers laminates beyond those offered in the standard offering. Laminates that are currently available in the program can be viewed in KI product specification tools. Requests to add laminates to the program can be submitted via the product modification request process. Please note, requests to add laminates to the program must include the laminate manufacturers name, color/pattern number, and finish code. Edge options are limited to standard edge colors. If a matching edge is required, this will need to be requested thru the product modification request process and may be subject to additional costs. Due to varying manufacturing processes and quality issues with some laminates, some requests may be denied. Extended lead times and minimum order quantities may apply on orders containing special laminates. Contact the product modification team for questions or additional information regarding special laminates and pricing.

SPECIAL SERVICES

Special Carton Marking

With specially marked information N/C

Shipping

Ships **knocked down, FOB Bonduel, WI 54107, freight prepaid.** Freight class 125.

Specifications and prices are subject to change without prior notice.

PRODUCT SPECIFICATIONS

Athens® Table

January 2025

TECHNICAL SPECIFICATIONS

Fixed-Height Table Bases

Tapered Base with 3" Diameter Column (ATH3)

Tapered round pedestal base is .07" thick steel. Tapered base is 26" in diameter for 36" square and 42" round tops only. Tapered base is 22" diameter for all other top sizes. 3" diameter column is constructed of 14-gauge steel. Table mounting plate is 7-gauge steel, and attaches to the underside of the worksurface using eight #12 Phillips pan head screws. Adjustable glides are 1" diameter, nickel plated with $\frac{5}{16}$ " stems. No tools are required for glide adjustment.

Disc Base with 4" Diameter Column (ATH4)

Flat round pedestal base is a .07" thick steel cover over a $\frac{1}{4}$ " thick steel plate. Base is 20" diameter for all 24" and 30" round table units and for all 24" square table units. Base is 24" diameter for all 36" round table units, for 42" round table units at 29" OTH (overall table height), and for all 30" square table units. Base is 32" diameter for 42" round table units at 42" OTH, and for all 36" and 42" square table units. 4" diameter column is constructed of 14-gauge steel. Table mounting plate is 7-gauge steel, and attaches to the underside of the worksurface using eight #12 Phillips pan head screws. Adjustable glides are 1" diameter nickel plated with $\frac{5}{16}$ " stems. No tools are required for glide adjustment.

Disc Base with 5" or 6" Diameter Column (ATH5)

Flat round pedestal base is a .07" thick steel cover over a $\frac{1}{4}$ " thick steel plate. Base is 32" diameter for all round and square table units. 5" diameter column is constructed of 14-gauge steel and is used for all 48" and 54" round table units and all square table units. 6" diameter column is used on 60" round table units and is constructed of 14-gauge steel. Table mounting plate is 7-gauge steel, and attaches to the underside of the worksurface with eight #12 Phillips pan head screws. Adjustable glides are 1" diameter nickel plated with $\frac{5}{16}$ " stems. No tools are required for glide adjustment.

Adjustable-Height Table Bases

Tapered Base with Adjustable-Height 3" Diameter Column (AH3A)

Tapered round pedestal base diameter is 23" for 30" diameter tops and 26" for 36" tops, and is constructed of a spun .07" thick steel cover over a $\frac{1}{4}$ " thick round disk. Pneumatic adjustable column assembly is constructed of a 70 mm diameter, 14-gauge lower tube and a 63 mm diameter, 14-gauge upper tube, and allows table height adjustment from $26\frac{3}{8}$ " to 44". Table mounting plate is $\frac{1}{4}$ " thick steel, and attaches to the underside of the worksurface using eight #12 Phillips pan head screws. Adjustable glides have 1" diameter nickel plated bases with $\frac{5}{16}$ " threaded stems. No tools are required for glide adjustment.

Fixed-Height Booth Table Base

Heavy-Weight Disc Base with 4" Diameter Column (AHDAA & AHDAC)

Heavy round pedestal base consists of a 14-gauge spun steel cover adhered to two $\frac{1}{4}$ " thick steel plates. Heavy-weight base is 20" in diameter for all 24" deep booth table units, is 24" in diameter for 26", 30" and 36" deep booth table units, and is 32" in diameter for 42" and 48" deep booth table units. 4" diameter column is constructed of 14-gauge steel. Table mounting plate is 7-gauge steel, and attaches to the underside of the worksurface using eight #12 Phillips pan head screws. Adjustable glides are 1" diameter nickel plated with $\frac{5}{16}$ " stems. No tools are required for glide adjustment.

Base Finishes

Standard base finishes include electroplated chrome and powder-coated, oven-cured paint.

Laminate Table Surfaces

Laminate tops feature a $\frac{1}{8}$ " thick high-density particleboard core with high-pressure laminate top and phenolic backing sheet. Total thickness of table top is $\frac{1}{4}$ ". Tops are pre-drilled.

Veneer Table Surfaces

Veneer tops feature a $\frac{1}{8}$ " thick high-density particleboard core with wood veneer and backing sheet, and finished with a catalyzed varnish finish. Total thickness of table top is $\frac{1}{4}$ ". Tops are pre-drilled.

DIMENSIONS

Athens Adjustable-Height Round Tables

Model Number	A Table Diameter	B Base Diameter	C Table Height	D Column Diameter
AH3R30ABB	30"	23"	26 $\frac{3}{8}$ " - 44"	3"
AH3R30ACH				
AH3R36ABB	36"	26"		
AH3R36ACH				

(model AH3R30ABB with tapered base (AH3A) shown)

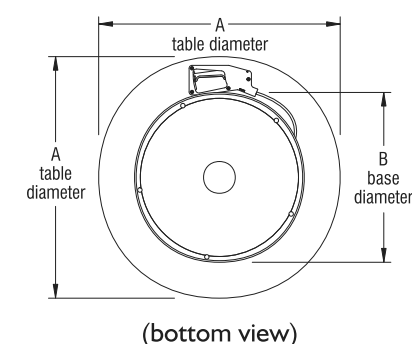
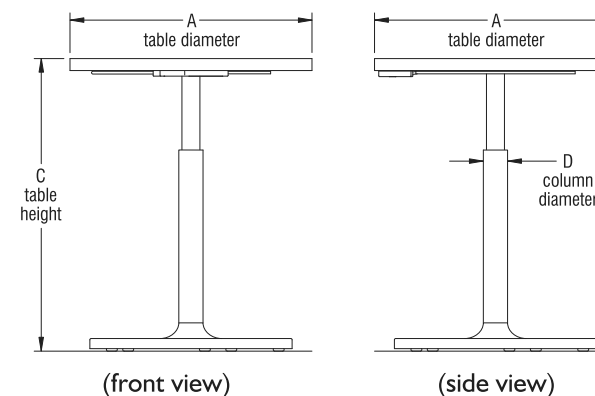



STATEMENT OF LINE

Athens Fixed-Height Square Tables



Square Table, 3" Column, 29" H
AH3S2429
AH3S3029
AH3S3629

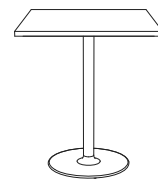

Square Table, 3" Column, 42" H
AH3S2442
AH3S3042

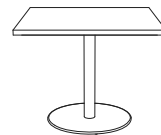

Square Table, 4" Column, 29" H
AH4S2429
AH4S3029
AH4S3629
AH4S4229



Square Table, 4" Column, 42" H
AH4S2442
AH4S3042
AH4S3642
AH4S4242

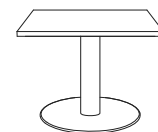

Square Table, 5" Column, 29" H
AH5S3629
AH5S4229
AH5S4829

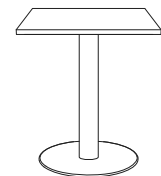

Square Table, 5" Column, 42" H
AH5S3629
AH5S4229
AH5S4829

Athens Fixed-Height Round Tables



Round Table, 3" Column, 29" H
AH3R2429
AH3R3029
AH3R3629
AH3R4229

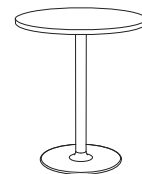

Square Table, 3" Column, 42" H
AH3R2442
AH3R3042
AH3R3642



Round Table, 4" Column, 29" H
AH4R2429
AH4R3029
AH4R3629
AH4R4229

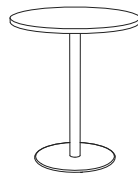

Round Table, 4" Column, 42" H
AH4R2442
AH4R3042
AH4R3642
AH4R4242

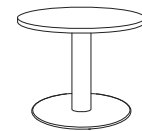

Round Table, 5" Column, 29" H
AH5R4829
AH5R5429

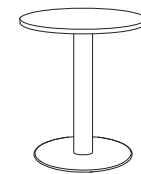

Round Table, 5" Column, 42" H
AH5R4842



**Surface Finish--Grade 1 Standard Laminate**

Beigewood
Belair
Biltmore Cherry
Black
Brighton Walnut
Castle Oak
Cherry Storm
Classic Linen
Cocobala
Crisp Linen
Designer White
Dove Grey
Florence Walnut
Friston Ash
Frosty White
Graphite Nebula
Grey
High Rise
Hollyberry
Island
Italian Silver Ash
Kensington Maple
Lapis Blue
Monticello Maple
North Sea
Ocean
Pinnacle Walnut
River Cherry
Shadow Zephyr
Sterling Ash
Titanium Evolv
White Nebula
White Sand
Windsor Mahogany

Surface Finish--Grade 2 Standard Laminate

Akira
Black Alicante
Black Hills Oak
Calcutta Marble
Dering Forest
Fawn Cypress
Ice Mist
Markerboard White
Valley Forge Elm
White River Forest

Surface Finish--Grade 3 Standard Laminate

Black Velvet
Cumberland Walnut
Designer White Velvet
Hartley Walnut
Nile Velvet
Raleigh Walnut
Solano Walnut
Spruce Velvet

Edge Color for 74P Edge

LBZ Akira
LBQ Beigewood
LBT Belair
LBK Biltmore Cherry
LBL Black
LCO Black Hills Oak
LCX Blue Grey
LCI Brighton Walnut
LCC Castle Oak
LRI Cayenne
LDR Cherry Storm
LDG Cocobala
LFC Cool Grey
LFH Cumberland Walnut
LFW Dering Forest
LGN Designer White
LGE Everglade Shade
LHE Fawn Cypress
LHY Flannel
LID Florence Walnut
LIT Friston Ash
LKM Frosty White
LLB Hartley Walnut
LMT Hazy Jade
LNA Italian Silver Ash
LON Kensington Maple
LPW Light Tone
LRY Mardi Gras
LSR Misty Brown
LAZ Monticello Maple
LTV Multiplex
LWL Nemo
LWN Nordic
LWY Pinnacle Walnut

LAK Poppy Red
LBY Rainforest
LBH Raleigh Walnut
LBH River Cherry
LCQ Rubber Ducky
LDF Sand
LFQ Sky Blue
LIM Solano Walnut
LMK Sterling Ash
LVF Surf's Up
LWR Tarragon
Ultra Blue
Valley Forge Elm
Warm Grey
White River Forest
Windsor Mahogany
Zesty Lime

Veneer Surface and Edge Colors for RE and PT Edge

LSC Cherry Storm on Maple
Cinnamon on Maple
Cocoa on Maple

EAK Kensington Maple on Maple
EBZ Monticello Maple on Maple
EBQ River Cherry on Maple

Wood Edge Finish for 34R and 34S Edge

EBT Biltmore Cherry on Maple
EBL Brighton Walnut on Maple
EBH Castle Oak on Maple
EGR Cherry Storm on Maple
EBW Cinnamon on Maple
ECO Cocoa on Maple
ECY Florence Walnut on Maple
ECX Kensington Maple on Maple
ECC Monticello Maple on Maple
ECG River Cherry on Maple

MBT and MBW are not supported with samples

Base Finish

EEV Black
EFQ Blue Grey
EFN Bronze Metallic
EFC Cayenne
EFH Champagne Metallic
EFW Cool Grey
EHW Cottonwood
EHJ Earthen Clay
EIT Espresso Metallic
EKM Everglade Shade
ELG Flannel
EMG Glitz Metallic
EMY Hazy Jade
EMT Honey Bee
EMB Light Tone
ENE Mardi Gras
END Misty Brown
EPW Nemo
EPR Nordic
ERQ Poppy Red
ERY Purple Haze
ERK Rainforest
ESA Raw Jasper
ESK Rubber Ducky
ESG Sand
EAZ Sky Blue
EAP Starlight Silver Metallic
ETQ Surf's Up
ETI Tarragon
EUB Twilight Shadow
EVF Ultra Blue
EWG Warm Grey
EWR Zesty Lime
EWY Chrome is available at an upcharge.
EZL

MMA
MMT
MRY

MBT
MBW
VOK
MCX
MCN
MCA
MFC
MMA
MMT
MRY

BL
GR
ZM
CY
CM
CG
CO
EY
EX
EV
FN
GZ
HJ
HY
LG
MG
MY
NE
ND
PR
PH
RQ
RJ
RK
SA
SK
SX
SP
TQ
TI
UB
WG
ZL

Finish Cards

View color swatches for items listed within this document.

Paints	Wood/Veneer	Molded Edges	Hard Plastics
Plastics/Poly	Laminates	Edge Styles	Glass

Certain options referenced may not be available on GSA Schedule.

Athens® Booth Tables

Square--Flat Disc Base, 4" Column, Fixed Height

Athens® Booth Tables

Square--Flat Disc Base, 4" Column, Fixed Height

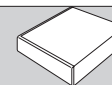

74P Edge (74P)

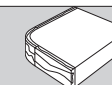

1-1/4" Wood Band Edge (34R)

MODEL	Features	A x B	MODEL NUMBER					Approx. Packaged Weight	74P Edge (74P)	1-1/4" Wood Band Edge (34R)	Laminate Grade 2 add to list price	Laminate Grade 3 add to list price
			Basic Model	Edge Style	Edge Color	Base Finish	Surface Finish					
Square Tables, 4" column, 29"H • 4" column diameter • 29" unit height • Square top with rounded corners • 32" base diameter on 48" tables • Flat disc base	Powdercoat	48 x 48"	AHDAC48P	<input type="checkbox"/> <input type="checkbox"/>	<input type="checkbox"/> <input type="checkbox"/>	<input type="checkbox"/>		230.00#	\$ 2056	\$ 3208	\$ 37	\$ 235
	Chrome	48 x 48"	AHDAC48C	<input type="checkbox"/> <input type="checkbox"/>	<input type="checkbox"/> <input type="checkbox"/>	CH		230.00#	2742	3817	37	235



AHDAC

A **B** **C** **D** **E**

HOW TO ORDER

Indicate the following information on order form:

- Quantity of each item.
- Model number, including options. See "How To Build a Model Number".
- Any special service required.

Note:

- The indicates that a choice is required.
- The absence of the indicates that no choice is required.
- Alpha-numeric characters in place of indicate that no other alternatives are available.

HOW TO BUILD A MODEL NUMBER

A Select basic model.

B Select edge style.
74P - 74P edge
34R - 1-1/4" Wood band, radius corner

C Select edge color.
 Refer to the **Product Color Options** page in this price list.
 Edge color offerings are based on edge style selections.

D Select base finish.
 Refer to the **Product Color Options** page in this price list.

E Select surface finish.
 Refer to the **Product Color Options** page in this price list.
 Surface finish offerings are based on edge style selections.

FINISH INFORMATION

Additional Laminate Offering
 KI offers laminates beyond those offered in the standard offering. Laminates that are currently available in the program can be viewed in KI product specification tools. Requests to add laminates to the program can be submitted via the product modification request process. Please note, requests to add laminates to the program must include the laminate manufacturer's name, color/pattern number, and finish code. Edge options are limited to standard edge colors. If a matching edge is required, this will need to be requested through the product modification request process and may be subject to additional costs. Due to varying manufacturing processes and quality issues with some laminates, some requests may be denied. Extended lead times and minimum order quantities may apply on orders containing special laminates. Contact the product modification team for questions or additional information regarding special laminates and pricing.

Color Match
 KI offers the additional option of color matching paint, polypropylene, or wood stain through Product Modification Requests. Contact customer service for details.

SPECIAL SERVICES

Special Carton Marking
 With specially marked information N/C

Shipping
 Ships **knocked down, FOB Bondue1, WI 54107, freight prepaid**. Fixed tables are freight class 70. Folding tables are freight class 125.

Specifications and prices are subject to change without prior notice.

Athens® Booth Tables

Rectangular--Flat Disc Base, 4" Column, Fixed Height

Athens® Booth Tables

Rectangular--Flat Disc Base, 4" Column, Fixed Height

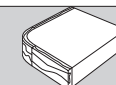
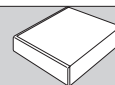

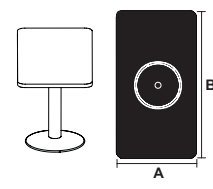
MODEL	Features	A x B	MODEL NUMBER					Approx. Packaged Weight	74P Edge (74P)	1-1/4" Wood Band Edge (34R)	Laminate Grade 2 add to list price	Laminate Grade 3 add to list price
			Basic Model	Edge Style	Edge Color	Base Finish	Surface Finish					
 <p>Rectangular Tables, 4" column, 29"H</p> <ul style="list-style-type: none"> 4" column diameter 29" unit height Rectangular top with rounded corners 20" base diameter on 24" tables 24" base diameter on 26", 30" and 36" tables 32" base diameter on 42" tables Flat disc base 	Powdercoat	24 x 48"	AHDAA2448P	<input type="checkbox"/> <input type="checkbox"/> <input type="checkbox"/> <input type="checkbox"/>	<input type="checkbox"/> <input type="checkbox"/> <input type="checkbox"/> <input type="checkbox"/>	<input type="checkbox"/> <input type="checkbox"/>		135.00#	\$ 1151	\$ 2001	\$ 19	\$ 120
	Chrome	24 x 48"	AHDAA2448C	<input type="checkbox"/> <input type="checkbox"/> <input type="checkbox"/> <input type="checkbox"/>	<input type="checkbox"/> <input type="checkbox"/> <input type="checkbox"/> <input type="checkbox"/>	CH		135.00#	1742	2578	19	120
	Powdercoat	26 x 48"	AHDAA2648P	<input type="checkbox"/> <input type="checkbox"/> <input type="checkbox"/> <input type="checkbox"/>	<input type="checkbox"/> <input type="checkbox"/> <input type="checkbox"/> <input type="checkbox"/>	<input type="checkbox"/> <input type="checkbox"/>		140.00#	1220	2112	19	120
	Chrome	26 x 48"	AHDAA2648C	<input type="checkbox"/> <input type="checkbox"/> <input type="checkbox"/> <input type="checkbox"/>	<input type="checkbox"/> <input type="checkbox"/> <input type="checkbox"/> <input type="checkbox"/>	CH		140.00#	1809	2605	19	120
	Powdercoat	30 x 48"	AHDAA3048P	<input type="checkbox"/> <input type="checkbox"/> <input type="checkbox"/> <input type="checkbox"/>	<input type="checkbox"/> <input type="checkbox"/> <input type="checkbox"/> <input type="checkbox"/>	<input type="checkbox"/> <input type="checkbox"/>		150.00#	1295	2166	27	178
	Chrome	30 x 48"	AHDAA3048C	<input type="checkbox"/> <input type="checkbox"/> <input type="checkbox"/> <input type="checkbox"/>	<input type="checkbox"/> <input type="checkbox"/> <input type="checkbox"/> <input type="checkbox"/>	CH		150.00#	1891	2660	27	178
	Powdercoat	36 x 48"	AHDAA3648P	<input type="checkbox"/> <input type="checkbox"/> <input type="checkbox"/> <input type="checkbox"/>	<input type="checkbox"/> <input type="checkbox"/> <input type="checkbox"/> <input type="checkbox"/>	<input type="checkbox"/> <input type="checkbox"/>		160.00#	1330	2331	37	235
	Chrome	36 x 48"	AHDAA3648C	<input type="checkbox"/> <input type="checkbox"/> <input type="checkbox"/> <input type="checkbox"/>	<input type="checkbox"/> <input type="checkbox"/> <input type="checkbox"/> <input type="checkbox"/>	CH		160.00#	1946	2933	37	235
	Powdercoat	42 x 48"	AHDAA4248P	<input type="checkbox"/> <input type="checkbox"/> <input type="checkbox"/> <input type="checkbox"/>	<input type="checkbox"/> <input type="checkbox"/> <input type="checkbox"/> <input type="checkbox"/>	<input type="checkbox"/> <input type="checkbox"/>		220.00#	2029	3152	37	235
	Chrome	42 x 48"	AHDAA4248C	<input type="checkbox"/> <input type="checkbox"/> <input type="checkbox"/> <input type="checkbox"/>	<input type="checkbox"/> <input type="checkbox"/> <input type="checkbox"/> <input type="checkbox"/>	CH		220.00#	2660	3762	37	235

A **B** **C** **D** **E**

AHDAA

HOW TO ORDER

- Indicate the following information on order form:
- Quantity of each item.
 - Model number, including options. See "How To Build a Model Number".
 - Any special service required.

Note:

- The indicates that a choice is required.
- The absence of the indicates that no choice is required.
- Alpha-numeric characters in place of indicate that no other alternatives are available.

HOW TO BUILD A MODEL NUMBER

- A** Select basic model.
- B** Select edge style.

74P	- 74P edge
34R	- 1-1/4" Wood band, radius corner
- C** Select edge color.
Refer to the **Product Color Options** page in this price list.
Edge color offerings are based on edge style selections.
- D** Select base finish.
Refer to the **Product Color Options** page in this price list.
- E** Select surface finish.
Refer to the **Product Color Options** page in this price list.
Surface finish offerings are based on edge style selections.

FINISH INFORMATION

Additional Laminate Offering
 KI offers laminates beyond those offered in the standard offering. Laminates that are currently available in the program can be viewed in KI product specification tools. Requests to add laminates to the program can be submitted via the product modification request process. Please note, requests to add laminates to the program must include the laminate manufacturer's name, color/pattern number, and finish code. Edge options are limited to standard edge colors. If a matching edge is required, this will need to be requested through the product modification request process and may be subject to additional costs. Due to varying manufacturing processes and quality issues with some laminates, some requests may be denied. Extended lead times and minimum order quantities may apply on orders containing special laminates. Contact the product modification team for questions or additional information regarding special laminates and pricing.

Color Match

KI offers the additional option of color matching paint, polypropylene, or wood stain through Product Modification Requests. Contact customer service for details.

SPECIAL SERVICES

Special Carton Marking

With specially marked information N/C

Shipping

Ships **knocked down, FOB Bondue1, WI 54107, freight prepaid**. Fixed tables are freight class 70. Folding tables are freight class 125.

Specifications and prices are subject to change without prior notice.

PRODUCT SPECIFICATIONS

Pillar® Tables

April 2025

TECHNICAL SPECIFICATIONS

Tabletops

Standard Tabletops

Standard tabletops are nominal 1 1/4" overall thickness with .030" thick high-pressure laminate top surface and .028" phenolic backer (bottom surface). The density of the core in standard tops is 45 lb/cu ft particleboard, M3 grade. The Pillar Table is available with the 2 mm (74P) edge.

90° Outside Curve Tabletops

Outside curve tabletops are nominal 1 1/4" overall thickness with .030" thick high-pressure laminate top surface and .028" phenolic backer (bottom surface). The density of the core in outside curve tops is 45 lb/cu ft particleboard, M3 grade. The tabletop is available with the 2 mm (74P) edge. This outside curve is supported at the underside, between two tables of equal depth by four 1 1/2-gauge (.125" thick) splice plates. While secured between two tables, no leg is required to support the tabletop.

Leg Assembly

Leg assemblies come in three variations to accommodate three overall table heights: 29" standard, 36" standard and 42" standing height depending on the table shape. The leg construction consist of a 2 1/4" O.D., 14-gauge steel tubing welded to a 1/4" thick 8" x 8" steel plate. A 1/4" thick steel insert is welded in the bottom of each leg tube with a 1/2-13 UNC threaded hole where the casters or glides attach. The legs are attached to the tabletop using #12 x 1" screws. Casters and glides are shipped in separate cartons and must to be installed upon assembly of the table.

Casters & Glides

Each table includes either casters or glides. Each caster table includes a set of locking and non-locking wheel casters. Casters are made of molded nylon and come in two colors. Glides are black nylon, overmolded on a steel insert for strength. Glides and casters are not interchangeable without changing the table height. Caster wheels are a minimum of 2 7/16" (63 mm) diameter. Caster wheel treads are a medium hard (75 max Shore A) for easy mobility on carpet or hard floors. Glides have a smooth bottom surface for mobility. Glides have a height adjustment range of 1" to allow for uneven surfaces.

Ganging Mechanism

Molded of black, high-strength nylon, the hook and peg combination draws tables together back-to-back or side-by-side. Once the ganging mechanism is installed, no tools are required when joining tables. Gangers are self-storing under the table when not in use. Tops are pre-drilled for placement of ganging pegs. Two gangers, four pegs and all mounting screws are included in the kit. One kit per table joint is required. Field installed.

Wire Management**Wire Trough**

The wire trough is a cord management accessory that is provided with the Pillar table if Pattern electrical components are specified with the order. If the Pillar table is specified with any 3-prong plug module unit, then a wire trough must be ordered separately. Constructed of 18-gauge steel with a powder-coated finish in all KI standard finishes. Screws are provided for attachment to the underside of the tabletop, and tops are pre-drilled for wire trough locations. Provides multiple access holes to feed wires, and includes cutouts for installation of additional Pattern snap-in RPT power modules.

Vertical Leg Wire Management

A color matched extrusion made of aluminum "snaps" to the Pillar leg, managing cables and wires exiting power modules or standard grommets installed on the tabletop. The extrusion is 12" long. Vertical wire managers are included when powered Pillar tables are ordered.



TECHNICAL SPECIFICATIONS

Wire Management (cont.)**Velcro® Wire Management**

The Velcro wire manager is constructed of 2" x 4 1/2" Velcro hook and loop material with a looped pull tab. The wire manager is provided with adhesive backing and screws for attachment to the underside of the top. Tops are pre-drilled for locating wire manager, but the manager may be applied in any convenient location. One or two Velcro wire managers are included when Pattern power modules are ordered, and wire clips are provided when power modules with 3-prong plugs are ordered. Field installed.

Grommets**Flip-Top Grommets for Dean® & Nacre® Power Modules**

Flip-top grommets are surface-mounted covers, constructed of 18-gauge steel. Grommets have a flip-up receding door and are identical in cutout size to the Nacre or Dean power modules listed below, which allows for retrofitting corresponding power modules at a later date. One grommet ships per table, which is located in the center of the tops. Two grommets ship per conference table, which are located near the center of the tops. Grommets are finished with powder-coat paint and available in all KI paint colors. The flip-up door is designed to allow cords to remain routed through the opening while it is closed and allows for more cord routing space when the flip-up door is opened. Field installed.

Circular Grommet for Node® Power Module

The Node circular grommet is an open top, surface-mounted grommet constructed of aluminum. The overall diameter of 3.15" fits into a 3" diameter cutout in the surface. One grommet ships per table, which is located in the center of the tops. Two grommets ship per conference table, which are located near the center of the tops. Grommets are finished with powder-coat paint and available in all KI paint colors. Not available in chrome. Field installed.

Power Modules**Dean In-Surface Power Module**

Dean In-Surface power module consists of two simplex receptacles (rated at 15 amps/125 volts), one USB-A port and one USB-C port, 2 amps per port, and one data jack opening. The module can be modified to fit various brand jacks. Data tree ships with Dean in-surface power modules. Data connectors are not supplied with the module and are purchased by the customer. The Dean in-surface module is 8.12" long by 2.31" wide by 2.5" high and fits securely into a 7.81" x 1.93" cutout. Module is mechanically attached to the worksurface with screws from the underside. The module has a molded plastic faceplate with steel trim and an aluminum housing. Modules comes standard with either 9' or 15' cord with a 3-prong plug, or a 20" cord with a Pattern™ connector. A 40" cord option is available for larger conference tables with two power modules. Dean power module is rated at 15 amps/120 volts and is UL listed.

Dean Clamp-On Power Module

Dean clamp-on power module consists of two simplex receptacles (rated at 15 amps/125 volts), one USB-A and one USB-C port, 2 amps per port. Dean clamp-on module is 5.50" long by 3.06" wide by 3.38" high. The module has a smooth molded plastic faceplate with an anodized aluminum housing. Clamp-on mounting style positions the module at a right angle to the worksurface and uses two thumb screws for attachment, without the need for table cutouts. Clamp is 3" wide, extends 1 3/4" onto edge of surface and can accommodate a maximum surface thickness of 1 1/2". Modules come standard with either 3', 9' or 15' cord with a 3-prong plug, or a 40" cord with a Pattern connector. Dean power module is rated at 15 amps/120 volts and is UL listed.

Dubbel™ Undersurface Power Module

Dubbel undersurface module consists of two simplex receptacles (rated at 15 amps/125 volts), one USB-A port and one USB-C port, 2 amps per port. Dubbel is 7.63" wide by 1.75" tall by 5.25" deep. The module is made of molded plastic and secures under the worksurface with two 5/16" x 2" Phillips round-head screws. Modules come standard with either 3', 9' or 15' cord with a 3-prong plug, or a 40" cord with a Pattern connector. Dubbel power module is rated at 15 amps/120 volts and is UL listed.



TECHNICAL SPECIFICATIONS

Power Modules (cont.)

Nacre Pop-Up In-Surface Module

Nacre Pop-Up In-Surface consists of two simplex receptacles (rated at 15 amps/125 volts), one USB-A port and one USB-C port, 2 amps per port, and one data jack opening. The module can be modified to fit various brand jacks. Data tree ships with Nacre power modules. Data connectors are not supplied with the module and are purchased by the customer. Nacre is 7.25" long by 3.31" wide by 2.92" high and fits securely into a 6.94" x 3" cutout with .38" radius corners. The module is made of molded plastic. The module is a pop-up design with a dampened spring-loaded mechanism to allow the unit to smoothly open for use and close smoothly when not in use. Modules come standard with either 9' or 15' cord with a 3-prong plug, or a 20" cord with a Pattern connector. A 40" cord option is available for larger conference tables with two power modules. Nacre power module is rated at 15 amps/120 volts and is UL listed.

Node® In-Surface Power Module

Node In-Surface power module consists of one simplex receptacle (rated at 15 amps/125 volts), includes one USB-A port, and one USB-C port, 2 amps per port. Node is 3.38" in diameter by 3.30" tall fits and securely into a 3" diameter cutout. The module housing is made of plastic with a powder-coat painted aluminum faceplate. Modules come standard with either 9' or 15' cord with a 3-prong plug, or a 20" or 40" cord with a Pattern connector. Node power module is rated at 15 amps/120 volts and is UL listed.

Snap-In RPT Power Module

Snap-In RPT module is only available for use with Pattern™ electrical system. Snap-in module consists of two simplex receptacles (rated at 15 amps/125 volts). Snap-in RPT fits securely in user facing cutouts located on the wire trough, mounted under the table. Modules comes standard with a 20" or 40" pattern connector, rated at 15 amps/120 volts and is UL listed.

Pattern Electrical System

Select Pillar table models can be configured with Pattern electrical system. The Pattern electrical system is ETL Listed, evaluated to safety standard UL 962A (USA) and CAN/CSA-C22.2 No. 308 (Canada). It allows for a maximum up to ten distribution blocks and up to 50' of power jumpers from the power infeed (in either direction), whichever comes first. Pattern allows up to eighteen power modules depending on table width, and connects to one 15-amp power supply cord (power infeed with 3-prong plug). Pattern is a non-sequential system and the infeed is compatible with ground fault interrupter (GFI/GFCI) outlets. Power modules for Pattern are specified as an option on Pillar tables.

Pattern Power Distribution Blocks

Pattern power distributions blocks are standalone connectors, each containing four port locations. Distribution blocks are included with appropriate power jumper and power infeed kits, so do not need to be ordered separately. Distribution blocks bring the power infeed, power jumpers, and power modules together and allow power to be efficiently supplied to each table. Two distribution block types are included with the Pattern system, grey and white.

Pattern Table-to-Table Power Jumper Kits

Pattern table-to-table jumper power kits come with one grey distribution block and an appropriately sized power jumper. Jumpers are nonsequential and are keyed on each end to connect between distribution blocks. Table-to-table power jumper kits are ordered separately, according to layout configuration.

Pattern Power Infeed Kits

The Pattern power infeed kit must be ordered separately. Site configurations vary and will affect the number of power infeeds required. The number and size of tables, as well as the number of receptacles per table and amperage needs in each ganging configuration will determine the number of power infeed kits required at any given installation. Infeeds can be installed anywhere in the run.

Kit comes with one grey Pattern power distribution block, one 12" power jumper, one white Pattern power distribution block and Pattern power infeed cord. Power infeed consists of a 15-amp 3-prong plug on one end of the 108" cord and a keyed connector at the opposite end of the cord. A Pattern quick-release tool is also included to assist with disconnecting connector ends from distribution blocks.

TECHNICAL SPECIFICATIONS

Modesty Panels

Optional 10" modesty panels are available on select Pillar models and available in perforated steel or laminate.

Laminated Modesty Panel

Laminated modesty panels have a .685" overall thickness with .30" thick high-pressure laminate on front and back surfaces. The density of the core inside the panel is 45 lb/cu ft particleboard, M3 grade. Modesty panels are 10" or 14³/₄" tall and vary in shape depending on the table it is paired with. On 48" wide rectangle tables, the modesty panel is 47³/₄" wide. On 90° inside curve tables, the modesty panel has a 54" radius, with an arc length of 85", so it can follow the curve of the back edge of the table. On 90° outside curve tables, the modesty panel has a 27¹/₂" radius, with an arc length of 38". The laminate is color matched to the tabletop. The modesty panel mounts to the table using 14-gauge (.075" thick) formed steel brackets, secured to the underside of the table.

Perforated Steel Modesty Panel

Panels are constructed of 14-gauge (.075" thick) by 10" tall perforated steel with powder-coated paint matched to the leg color. On 48" wide rectangular tables, the modesty panel is 47³/₄" wide. On 90° inside curve tables, the modesty panel has a 54" radius, with an arc length of 85", so it can follow the curve of the back edge of the table. On 90° outside curve tables, the modesty panel has a 27¹/₂" radius, with an arc length of 38". The modesty panel mounts to the table using 14-gauge (.075" thick) formed steel brackets, secured to the underside of the table.

Note: When specifying a perforated steel modesty panel on a table with chrome legs, the modesty panel will be flannel.

Polyester Felt Modesty Panel

Polyester felt modesty panels are constructed from a sound-absorbing, 100% polyester felt. The panels have a density of 0.5 lb/ft² and is sound absorbing tested to ASTM C423 with an NRC rating of .44 when using no air gap (A-Mount testing method) and an NRC rating of .81" with 2" air gap. The polyester felt is in accordance with ASTM-E84 and achieve a Class A Flame Spread. Standard sizes are 9¹/₄" high on 29" high tables, or 14³/₄" high on 36" and 42" high tables by 29", 35", 41", 47", 53", 59" and 65" wide.

Mounting Hooks

The mounting hooks are 18-gauge steel and attach underneath the tabletop using two steel screws. Panels 29", 35", 41" and 47" wide use two hooks per panel. Panels 53", 59" and 65" wide use three hooks per panel.



STATEMENT OF LINE

Pillar® Tables

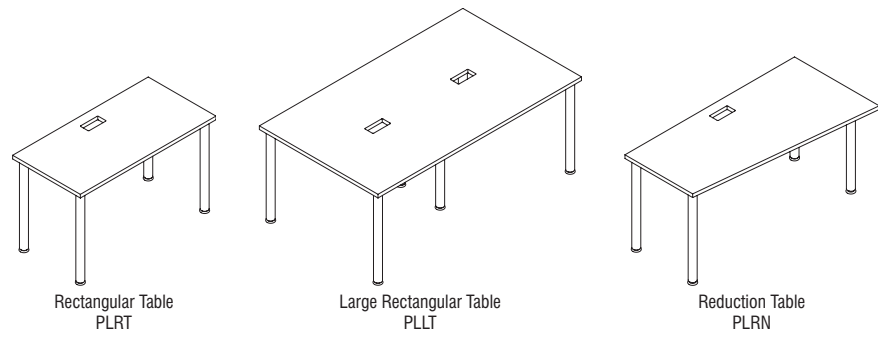

STATEMENT OF LINE

Pillar® Tables for MyPlace™ Lounge Furniture

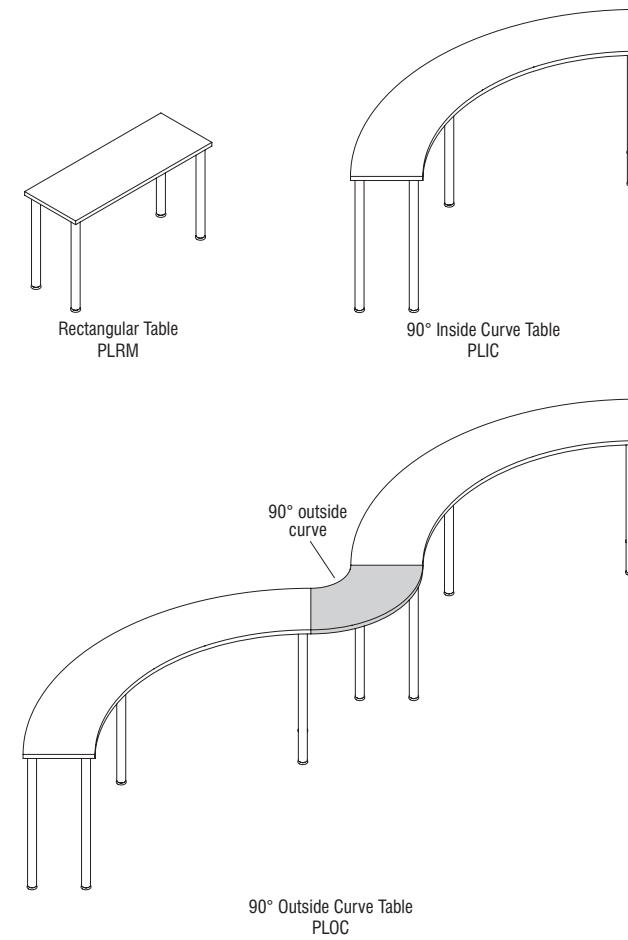

Pillar Table Modesty Panels for MyPlace Lounge Furniture

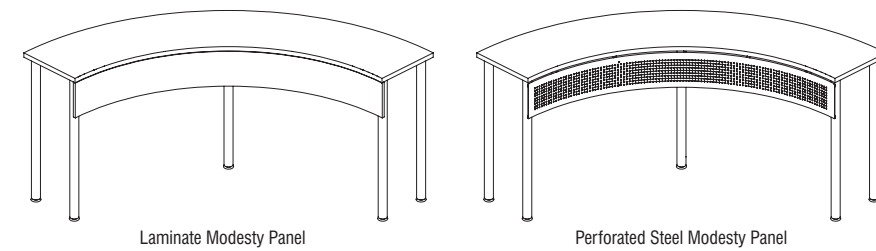



Surface Finish--Grade 1 Standard Laminate

Beigewood
Belair
Biltmore Cherry
Black
Brighton Walnut
Castle Oak
Cherry Storm
Classic Linen
Cocobala
Crisp Linen
Designer White
Dove Grey
Florence Walnut
Friston Ash
Frosty White
Graphite Nebula
Grey
High Rise
Hollyberry
Island
Italian Silver Ash
Kensington Maple
Lapis Blue
Monticello Maple
North Sea
Ocean
Pinnacle Walnut
River Cherry
Shadow Zephyr
Sterling Ash
Titanium Evolv
White Nebula
White Sand
Windsor Mahogany

Paint Finish

LBZ	Black
LBQ	Blue Grey
LBT	Bronze Metallic
LBK	Cayenne
LBW	Champagne Metallic
LCO	Chrome
LCX	Cool Grey
LCI	Cottonwood
LCC	Earthen Clay
LRI	Espresso Metallic
LDR	Everglade Shade
LDG	Flannel
LFC	Glitz Metallic
LFH	Hazy Jade
LFW	Honey Bee
LGN	Light Tone
LGE	Mardi Gras
LHE	Misty Brown
LHY	Nemo
LID	Nordic
LIT	Poppy Red
LKM	Purple Haze
LLB	Rainforest
LMT	Raw Jasper
LNA	Rubber Ducky
LON	Sand
LPW	Sky Blue
LRY	Starlight Silver Metallic
LSR	Surf's Up
LAZ	Tarragon
LTV	Twilight Shadow
LWL	Ultra Blue
LWN	Warm Grey
LWY	Zesty Lime

BL	Flannel
GR	Florence Walnut
ZM	Friston Ash
CY	Frosty White
CM	Hartley Walnut
CH	Hazy Jade
CG	Italian Silver Ash
CO	Kensington Maple
EY	Light Tone
EX	Mardi Gras
EV	Misty Brown
FN	Monticello Maple
GZ	Multiplex
HJ	Nemo
HY	Nordic
LG	Pinnacle Walnut
MG	Poppy Red
MY	Rainforest
NE	Raleigh Walnut
ND	River Cherry
PR	Rubber Ducky
PH	Sand
RQ	Sky Blue
RJ	Solano Walnut
RK	Sterling Ash
SA	Surf's Up
SK	Tarragon
SX	Twilight Shadow
SP	Ultra Blue
TQ	Valley Forge Elm
TI	Warm Grey
UB	White River Forest
WG	Windsor Mahogany
ZL	Zesty Lime

EFN	Flannel
EFC	Florence Walnut
EFH	Friston Ash
EFW	Frosty White
EHW	Hartley Walnut
EHJ	Hazy Jade
EIT	Italian Silver Ash
EKM	Kensington Maple
ELG	Light Tone
EMG	Mardi Gras
EMY	Misty Brown
EMT	Monticello Maple
EMB	Multiplex
ENE	Nemo
END	Nordic
EPW	Pinnacle Walnut
EPR	Poppy Red
ERQ	Rainforest
ERW	Raleigh Walnut
ERY	River Cherry
ERK	Rubber Ducky
ESA	Sand
ESK	Sky Blue
ESG	Solano Walnut
EAZ	Sterling Ash
ESP	Surf's Up
ETQ	Tarragon
ETI	Twilight Shadow
EUB	Ultra Blue
EVF	Valley Forge Elm
EWG	Warm Grey
EWR	White River Forest
EWY	Windsor Mahogany
EZL	Zesty Lime

Surface Finish--Grade 2 Standard Laminate

Akira
Black Alicante
Black Hills Oak
Calcutta Marble
Dering Forest
Fawn Cypress
Ice Mist
Markerboard White
Valley Forge Elm
White River Forest

Booth Tables: Steel modesty panel color matches the paint finish with the following exception:
-When paint finish is chrome, steel modesty panel will be flannel.

Edge Color for 74P Edge

LAK	Akira
LBY	Black Alicante
LBH	Black Hills Oak
LCQ	Calcutta Marble
LDF	Dering Forest
LFQ	Fawn Cypress
LIM	Ice Mist
LMK	Markerboard White
LVF	Valley Forge Elm
LWR	White River Forest

Nacre, Dean, Node Grommet Color (Corded, Pattern)

EAK	Black grommet
EBZ	Blue Grey grommet
EBQ	Bronze Metallic grommet
EBT	Champagne Metallic grommet
EBL	Cool Grey grommet
EBH	Cottonwood grommet
EGR	Flannel grommet
EBW	Misty Brown grommet
ECO	Starlight Silver grommet
ECY	Warm Grey grommet

Surface Finish--Grade 3 Standard Laminate

Black Velvet
Cumberland Walnut
Designer White Velvet
Hartley Walnut
Nile Velvet
Raleigh Walnut
Solano Walnut
Spruce Velvet

LBV	Black Velvet
LCJ	Cumberland Walnut
LDE	Designer White Velvet
LHW	Hartley Walnut
LNL	Nile Velvet
LRW	Raleigh Walnut
LSG	Solano Walnut
LSC	Spruce Velvet

Nacre, Dubbel, Dean, Node Power Module Color (Corded, Pattern)

ECX	Black
ECC	Cool Grey
ECG	Cottonwood
ECJ	Warm Grey
EDF	
EDR	
EEV	
EFQ	

Finish Cards

View color swatches for items listed within this document.

- [Paints](#)
- [Wood/Veneer](#)
- [Molded Edges](#)
- [Hard Plastics](#)
- [Plastics/Poly](#)
- [Laminates](#)
- [Edge Styles](#)
- [Glass](#)

Certain options referenced may not be available on GSA Schedule.

MyPlace™ Pillar™ Tables

Inside Curve - 29" High, 18" and 24" Deep

MyPlace™ Pillar™ Tables

Inside Curve - 29" High, 18" and 24" Deep

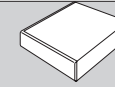

74P Edge (74P)

\$ 2115

A x B	MODEL NUMBER										Approx. Packaged Weight	74P Edge (74P)	Laminate Grade 2 add to list price	Laminate Grade 3 add to list price	Steel Modesty Panel add to list price	Laminate Modesty Panel add to list price
	Basic Model	Edge Style	Power Option	Modesty Panel	Edge Color	Surface Finish	Paint Color	Base	Grommet/Module Color	Cord (feet)						
18 x 102"	PLIC18	<input type="checkbox"/>	<input type="checkbox"/>	<input type="checkbox"/>	<input type="checkbox"/>	<input type="checkbox"/>	<input type="checkbox"/>	<input type="checkbox"/>	<input type="checkbox"/>	<input type="checkbox"/>	0.00#	\$ 2115	\$ 105	\$ 709	\$ 364	\$ 2038
24 x 110"	PLIC24	<input type="checkbox"/>	<input type="checkbox"/>	<input type="checkbox"/>	<input type="checkbox"/>	<input type="checkbox"/>	<input type="checkbox"/>	<input type="checkbox"/>	<input type="checkbox"/>	<input type="checkbox"/>	0.00#	\$ 2379	\$ 105	\$ 709	\$ 364	\$ 2038

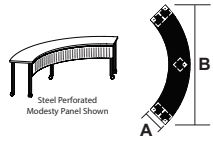

- PLIC
Inside Curve - 18"D
- Tables are designed for maximum leg spacing
 - Glides and casters are not interchangeable without changing the height of the table
 - Vertical and horizontal wire management are included automatically when power options are specified
 - Ganger kit with 2 ganging hooks included
 - Post Leg at 29" high

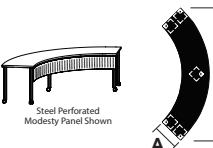

- PLIC
Inside Curve - 24"D
- Tables are designed for maximum leg spacing
 - Glides and casters are not interchangeable without changing the height of the table
 - Vertical and horizontal wire management are included automatically when power options are specified
 - Ganger kit with 2 ganging hooks included
 - Post Leg at 29" high

HOW TO ORDER

- Indicate the following information on order form:
- Quantity of each item.
 - Model number, including options. See "How To Build a Model Number".
 - Any special service required.

Note: • The indicates that a choice is required.
• The absence of the indicates that no choice is required.
• Alpha-numeric characters in place of indicate that no other alternatives are available.

HOW TO BUILD A MODEL NUMBER

- A** Select basic model.
B Select edge style.
C Select power option.
- NNN** - No grommets, power, wire management/No cutouts
 - WMO** - Wire management only-no cutouts; add \$70
 - MA2** - Modules, Nacre pop-up w/USB-A/C (2); add \$889
 - MB2** - Modules, Dubbel under-surface w/ dual USB-A/C (2); add \$560
 - MD2** - Modules, Dean in-surface w/USB-A/C (2); add \$749
 - MO2** - Modules, Node in-surface w/USB-A/C (2); add \$560
 - GA2** - Grommets, Nacre (2); add \$432
 - GD2** - Grommets, Dean (2); add \$432
 - GO2** - Grommets, Node (2); add \$293

CORD LENGTH: 9' or 15' is optional on all module options.

WIRE MANAGEMENT: All options except NNN include vertical and horizontal wire management.

- D** Select modesty panel.
NMP - No modesty panel
SMP - Perforated steel modesty panel
LMP - Laminate modesty panel
See pricing column for full modesty panel upcharge.
- E** Select edge color.
Refer to the **Product Color Options** page in this price list.
- F** Select surface finish.
Refer to the **Product Color Options** page in this price list.
- G** Select paint finish.
Refer to the **Product Color Options** page in this price list.
If chrome is specified with a steel modesty panel, modesty panel will be flannel.

- H** Select base.
CST - Casters
GLD - Glides
Casters=2 locking/2 non-locking, black wheel, silver hub
- I** Select grommet/module color.
Refer to the **Product Color Options** page in this price list.
- J** Select Cord Length (feet).
9 - 9' cord length
15 - 15' cord length

FINISH INFORMATION

Additional Laminate Offering
KI offers laminates beyond those offered in the standard offering. Laminates that are currently available in the program can be viewed in KI product specification tools. Requests to add laminates to the program can be submitted via the product modification request process. Please note, requests to add laminates to the program must include the laminate manufacturer's name, color/pattern number, and finish code. Edge options are limited to standard edge colors. If a matching edge is required, this will need to be requested through the product modification request process and may be subject to additional costs. Due to varying manufacturing processes and quality issues with some laminates, some requests may be denied. Extended lead times and minimum order quantities may apply on orders containing special laminates. Contact the product modification team for questions or additional information regarding special laminates and pricing.

Color Match
KI offers the additional option of color matching paint, polypropylene, or wood stain through Product Modification Requests. Contact customer service for details.

SPECIAL SERVICES

Special Carton Marking
With specially marked information N/C

Shipping
Ships **knocked down, FOB Bonduel, WI 54107, freight prepaid.** Freight class 125.

Specifications and prices are subject to change without prior notice.

MyPlace™ Pillar™ Tables

Inside Curve - 36" High, 18" and 24" Deep

MyPlace™ Pillar™ Tables

Inside Curve - 36" High, 18" and 24" Deep

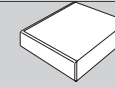

74P Edge (74P)

\$ 2168

A x B	MODEL NUMBER										Approx. Packaged Weight	74P Edge (74P)	Laminate Grade 2 add to list price	Laminate Grade 3 add to list price	Steel Modesty Panel add to list price	Laminate Modesty Panel add to list price
	Basic Model	Edge Style	Power Option	Modesty Panel	Edge Color	Surface Finish	Paint Color	Base	Grommet/Module Color	Cord (feet)						
18 x 102"	PLIC18H36	<input type="checkbox"/>	<input type="checkbox"/>	<input type="checkbox"/>	<input type="checkbox"/>	<input type="checkbox"/>	<input type="checkbox"/>	<input type="checkbox"/>	<input type="checkbox"/>	<input type="checkbox"/>	0.00#	\$ 2168	\$ 105	\$ 709	\$ 364	\$ 2038
24 x 110"	PLIC24H36	<input type="checkbox"/>	<input type="checkbox"/>	<input type="checkbox"/>	<input type="checkbox"/>	<input type="checkbox"/>	<input type="checkbox"/>	<input type="checkbox"/>	<input type="checkbox"/>	<input type="checkbox"/>	0.00#	\$ 2433	\$ 105	\$ 709	\$ 364	\$ 2038

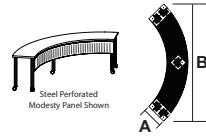

PLIC

Inside Curve - 18"D

- Tables are designed for maximum leg spacing
- Glides and casters are not interchangeable without changing the height of the table
- Vertical and horizontal wire management are included automatically when power options are specified
- Ganger kit with 2 ganging hooks included
- Post Leg at 36" high

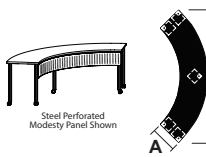

PLIC

Inside Curve - 24"D

- Tables are designed for maximum leg spacing
- Glides and casters are not interchangeable without changing the height of the table
- Vertical and horizontal wire management are included automatically when power options are specified
- Ganger kit with 2 ganging hooks included
- Post Leg at 36" high

A B C D E F G H I J

HOW TO ORDER

- Indicate the following information on order form:
1. Quantity of each item.
 2. Model number, including options. See "How To Build a Model Number".
 3. Any special service required.

Note: • The indicates that a choice is required.
 • The absence of the indicates that no choice is required.
 • Alpha-numeric characters in place of indicate that no other alternatives are available.

HOW TO BUILD A MODEL NUMBER

- A** Select basic model.
- B** Select edge style.
74P - 74P edge
- C** Select power option.
NNN - No grommets, power, wire management/No cutouts
WMO - Wire management only-no cutouts; add \$70
MA2 - Modules, Nacre pop-up w/USB-A/C (2); add \$889
MB2 - Modules, Dubbel under-surface w/ dual USB-A/C (2); add \$560
MD2 - Modules, Dean in-surface w/USB-A/C (2) ; add \$749
MO2 - Modules, Node in-surface w/USB-A/C (2); add \$560
GA2 - Grommets, Nacre (2); add \$432
GD2 - Grommets, Dean (2); add \$432
GO2 - Grommets, Node (2); add \$293

CORD LENGTH: 9' or 15' is optional on all module options.

WIRE MANAGEMENT: All options except NNN include vertical and horizontal wire management.

- D** Select modesty panel.
NMP - No modesty panel
SMP - Perforated steel modesty panel
LMP - Laminate modesty panel
 See pricing column for full modesty panel upcharge.
- E** Select edge color.
 Refer to the **Product Color Options** page in this price list.
- F** Select surface finish.
 Refer to the **Product Color Options** page in this price list.
- G** Select paint finish.
 Refer to the **Product Color Options** page in this price list.
 If chrome is specified with a steel modesty panel, modesty panel will be flannel.

- H** Select base.
CST - Casters
GLD - Glides
 Casters=2 locking/2 non-locking, black wheel, silver hub
- I** Select grommet/module color.
 Refer to the **Product Color Options** page in this price list.
- J** Select Cord Length (feet).
9 - 9' cord length
15 - 15' cord length

FINISH INFORMATION

Additional Laminate Offering

KI offers laminates beyond those offered in the standard offering. Laminates that are currently available in the program can be viewed in KI product specification tools. Requests to add laminates to the program can be submitted via the product modification request process. Please note, requests to add laminates to the program must include the laminate manufacturer's name, color/pattern number, and finish code. Edge options are limited to standard edge colors. If a matching edge is required, this will need to be requested through the product modification request process and may be subject to additional costs. Due to varying manufacturing processes and quality issues with some laminates, some requests may be denied. Extended lead times and minimum order quantities may apply on orders containing special laminates. Contact the product modification team for questions or additional information regarding special laminates and pricing.

Color Match

KI offers the additional option of color matching paint, polypropylene, or wood stain through Product Modification Requests. Contact customer service for details.

SPECIAL SERVICES

Special Carton Marking

With specially marked information N/C

Shipping
 Ships **knocked down, FOB Bonduel, WI 54107, freight prepaid.** Freight class 125.

Specifications and prices are subject to change without prior notice.

MyPlace™ Pillar™ Tables

Inside Curve - 42" High, 18" and 24" Deep

MyPlace™ Pillar™ Tables

Inside Curve - 42" High, 18" and 24" Deep

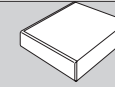

74P Edge (74P)
\$ 2221

A x B	MODEL NUMBER										Approx. Packaged Weight	74P Edge (74P)	Laminate Grade 2 add to list price	Laminate Grade 3 add to list price	Steel Modesty Panel add to list price	Laminate Modesty Panel add to list price
	Basic Model	Edge Style	Power Option	Modesty Panel	Edge Color	Surface Finish	Paint Color	Base	Grommet/Module Color	Cord (feet)						
18 x 102"	PLIC18H42	<input type="checkbox"/>	<input type="checkbox"/>	<input type="checkbox"/>	<input type="checkbox"/>	<input type="checkbox"/>	<input type="checkbox"/>	<input type="checkbox"/>	<input type="checkbox"/>	<input type="checkbox"/>	0.00#	\$ 2221	\$ 105	\$ 709	\$ 364	\$ 2038
24 x 110"	PLIC24H42	<input type="checkbox"/>	<input type="checkbox"/>	<input type="checkbox"/>	<input type="checkbox"/>	<input type="checkbox"/>	<input type="checkbox"/>	<input type="checkbox"/>	<input type="checkbox"/>	<input type="checkbox"/>	0.00#	\$ 2485	\$ 105	\$ 709	\$ 364	\$ 2038

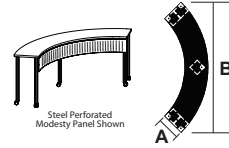

- PLIC
Inside Curve - 18"D
- Tables are designed for maximum leg spacing
 - Glides and casters are not interchangeable without changing the height of the table
 - Vertical and horizontal wire management are included automatically when power options are specified
 - Ganger kit with 2 ganging hooks included
 - Post Leg at 42" high

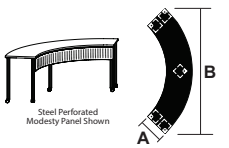

- PLIC
Inside Curve - 24"D
- Tables are designed for maximum leg spacing
 - Glides and casters are not interchangeable without changing the height of the table
 - Vertical and horizontal wire management are included automatically when power options are specified
 - Ganger kit with 2 ganging hooks included
 - Post Leg at 42" high

A B C D E F G H I J

HOW TO ORDER

- Indicate the following information on order form:
- Quantity of each item.
 - Model number, including options. See "How To Build a Model Number".
 - Any special service required.

Note: • The indicates that a choice is required.
• The absence of the indicates that no choice is required.
• Alpha-numeric characters in place of indicate that no other alternatives are available.

HOW TO BUILD A MODEL NUMBER

- A** Select basic model.
- B** Select edge style.
74P - 74P edge
- C** Select power option.
NNN - No grommets, power, wire management/No cutouts
WMO - Wire management only-no cutouts; add \$70
MA2 - Modules, Nacre pop-up w/USB-A/C (2); add \$889
MB2 - Modules, Dubbel under-surface w/ dual USB-A/C (2); add \$560
MD2 - Modules, Dean in-surface w/USB-A/C (2); add \$749
MO2 - Modules, Node in-surface w/USB-A/C (2); add \$560
GA2 - Grommets, Nacre (2); add \$432
GD2 - Grommets, Dean (2); add \$432
GO2 - Grommets, Node (2); add \$293

CORD LENGTH: 9' or 15' is optional on all module options.

WIRE MANAGEMENT: All options except NNN include vertical and horizontal wire management.

- D** Select modesty panel.
NMP - No modesty panel
SMP - Perforated steel modesty panel
LMP - Laminate modesty panel
See pricing column for full modesty panel upcharge.
- E** Select edge color.
Refer to the **Product Color Options** page in this price list.
- F** Select surface finish.
Refer to the **Product Color Options** page in this price list.
- G** Select paint finish.
Refer to the **Product Color Options** page in this price list.
If chrome is specified with a steel modesty panel, modesty panel will be flannel.

- H** Select base.
CST - Casters
GLD - Glides
Casters=2 locking/2 non-locking, black wheel, silver hub
- I** Select grommet/module color.
Refer to the **Product Color Options** page in this price list.
- J** Select Cord Length (feet).
9 - 9' cord length
15 - 15' cord length

FINISH INFORMATION

Additional Laminate Offering
KI offers laminates beyond those offered in the standard offering. Laminates that are currently available in the program can be viewed in KI product specification tools. Requests to add laminates to the program can be submitted via the product modification request process. Please note, requests to add laminates to the program must include the laminate manufacturer's name, color/pattern number, and finish code. Edge options are limited to standard edge colors. If a matching edge is required, this will need to be requested through the product modification request process and may be subject to additional costs. Due to varying manufacturing processes and quality issues with some laminates, some requests may be denied. Extended lead times and minimum order quantities may apply on orders containing special laminates. Contact the product modification team for questions or additional information regarding special laminates and pricing.

Color Match
KI offers the additional option of color matching paint, polypropylene, or wood stain through Product Modification Requests. Contact customer service for details.

SPECIAL SERVICES

Special Carton Marking
With specially marked information N/C

Shipping
Ships **knocked down, FOB Bonduel, WI 54107, freight prepaid.** Freight class 125.

Specifications and prices are subject to change without prior notice.

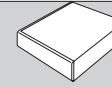

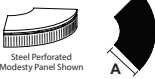
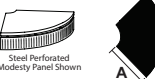
MODEL	A x B	MODEL NUMBER							Approx. Packaged Weight	74P Edge (74P)	Laminate Grade 2 add to list price	Laminate Grade 3 add to list price	Steel Modesty Panel add to list price	Laminate Modesty Panel add to list price
		Basic Model	Edge Style	Power Option	Modesty Panel	Edge Color	Surface Finish	Paint Color						
 Outside Curve - 18"D • Top only; attached with 4 splice plates PLOC	18"	PLOC18	<input type="checkbox"/> <input type="checkbox"/> <input type="checkbox"/>	NNN	<input type="checkbox"/> <input type="checkbox"/> <input type="checkbox"/>	<input type="checkbox"/> <input type="checkbox"/> <input type="checkbox"/>	<input type="checkbox"/> <input type="checkbox"/>	<input type="checkbox"/> <input type="checkbox"/>	0.00#	\$ 608	\$ 53	\$ 368	\$ 351	\$ 1083
 Outside Curve - 24"D • Top only; attached with 4 splice plates PLOC	24"	PLOC24	<input type="checkbox"/> <input type="checkbox"/> <input type="checkbox"/>	NNN	<input type="checkbox"/> <input type="checkbox"/> <input type="checkbox"/>	<input type="checkbox"/> <input type="checkbox"/> <input type="checkbox"/>	<input type="checkbox"/> <input type="checkbox"/>	<input type="checkbox"/> <input type="checkbox"/>	0.00#	\$ 660	\$ 53	\$ 368	\$ 351	\$ 1083

A B C D E F G

HOW TO ORDER

- Indicate the following information on order form:
- Quantity of each item.
 - Model number, including options. See "How To Build a Model Number".
 - Any special service required.

Note: • The indicates that a choice is required.
 • The absence of the indicates that no choice is required.
 • Alpha-numeric characters in place of indicate that no other alternatives are available.

HOW TO BUILD A MODEL NUMBER

- A** Select basic model.
- B** Select edge style.
74P - 74P edge
- C** Select power option.
NNN - No grommets, power, wire management/No cutouts
- D** Select modesty panel.
NMP - No modesty panel
SMP - Perforated steel modesty panel
LMP - Laminate modesty panel
 See pricing column for full modesty panel upcharge.
- E** Select edge color.
 Refer to the **Product Color Options** page in this price list.
- F** Select surface finish.
 Refer to the **Product Color Options** page in this price list.
- G** Select paint finish.
 Refer to the **Product Color Options** page in this price list.
 Steel modesty panel color matches the paint finish.
 When planned with other tables with chrome bases, specify flannel paint finish.

FINISH INFORMATION

Additional Laminate Offering

KI offers laminates beyond those offered in the standard offering. Laminates that are currently available in the program can be viewed in KI product specification tools. Requests to add laminates to the program can be submitted via the product modification request process. Please note, requests to add laminates to the program must include the laminate manufacturer's name, color/pattern number, and finish code. Edge options are limited to standard edge colors. If a matching edge is required, this will need to be requested through the product modification request process and may be subject to additional costs. Due to varying manufacturing processes and quality issues with some laminates, some requests may be denied. Extended lead times and minimum order quantities may apply on orders containing special laminates. Contact the product modification team for questions or additional information regarding special laminates and pricing.

Color Match

KI offers the additional option of color matching paint, polypropylene, or wood stain through Product Modification Requests. Contact customer service for details.

SPECIAL SERVICES

Special Carton Marking

With specially marked information N/C

Shipping

Ships **knocked down, FOB Bonduel, WI 54107, freight prepaid**. Freight class 125.

Specifications and prices are subject to change without prior notice.

MyPlace™ Pillar™ Tables

Rectangular - 29" High, 18" and 24" Deep

MyPlace™ Pillar™ Tables

Rectangular - 29" High, 18" and 24" Deep

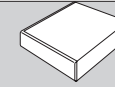

74P Edge (74P)
\$ 794

A x B	MODEL NUMBER										Approx. Packaged Weight	74P Edge (74P)	Laminate Grade 2 add to list price	Laminate Grade 3 add to list price	Steel Modesty Panel add to list price	Laminate Modesty Panel add to list price
	Basic Model	Edge Style	Power Option	Modesty Panel	Edge Color	Surface Finish	Paint Color	Base	Grommet/Module Color	Cord (feet)						
18 x 48"	PLRM1848	<input type="checkbox"/> <input type="checkbox"/>	<input type="checkbox"/> <input type="checkbox"/>	<input type="checkbox"/> <input type="checkbox"/>	<input type="checkbox"/> <input type="checkbox"/>	<input type="checkbox"/> <input type="checkbox"/>	<input type="checkbox"/> <input type="checkbox"/>	<input type="checkbox"/> <input type="checkbox"/>	<input type="checkbox"/> <input type="checkbox"/>	<input type="checkbox"/> <input type="checkbox"/>	0.00#	\$ 794	\$ 19	\$ 120	\$ 286	\$ 351
24 x 48"	PLRM2448	<input type="checkbox"/> <input type="checkbox"/>	<input type="checkbox"/> <input type="checkbox"/>	<input type="checkbox"/> <input type="checkbox"/>	<input type="checkbox"/> <input type="checkbox"/>	<input type="checkbox"/> <input type="checkbox"/>	<input type="checkbox"/> <input type="checkbox"/>	<input type="checkbox"/> <input type="checkbox"/>	<input type="checkbox"/> <input type="checkbox"/>	<input type="checkbox"/> <input type="checkbox"/>	0.00#	\$ 845	\$ 19	\$ 120	\$ 286	\$ 351

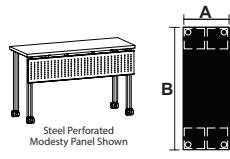

- PLRM
Rectangular Tables - 18"D
- Tables are designed for maximum leg spacing
 - Glides and casters are not interchangeable without changing the height of the table
 - Vertical and horizontal wire management are included automatically when power options are specified
 - Ganger kit with 2 ganging hooks included
 - Post Leg at 29" hig, le

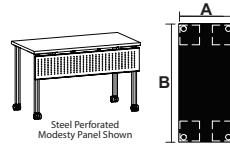

- PLRM
Rectangular Tables - 24"D
- Tables are designed for maximum leg spacing
 - Glides and casters are not interchangeable without changing the height of the table
 - Vertical and horizontal wire management are included automatically when power options are specified
 - Ganger kit with 2 ganging hooks included
 - Post Leg at 29" high

A B C D E F G H I J

HOW TO ORDER

- Indicate the following information on order form:
- Quantity of each item.
 - Model number, including options. See "How To Build a Model Number".
 - Any special service required.

Note: • The indicates that a choice is required.
• The absence of the indicates that no choice is required.
• Alpha-numeric characters in place of indicate that no other alternatives are available.

HOW TO BUILD A MODEL NUMBER

- A** Select basic model.
B Select edge style.
C Select power option.
D Select modesty panel.
E Select edge color.
F Select surface finish.
G Select paint finish.

WIRE MANAGEMENT: All options except NNN include vertical and horizontal wire management.

- H** Select base.
I Select grommet/module color.
J Select Cord Length (feet).

FINISH INFORMATION

Additional Laminate Offering
KI offers laminates beyond those offered in the standard offering. Laminates that are currently available in the program can be viewed in KI product specification tools. Requests to add laminates to the program can be submitted via the product modification request process. Please note, requests to add laminates to the program must include the laminate manufacturer's name, color/pattern number, and finish code. Edge options are limited to standard edge colors. If a matching edge is required, this will need to be requested through the product modification request process and may be subject to additional costs. Due to varying manufacturing processes and quality issues with some laminates, some requests may be denied. Extended lead times and minimum order quantities may apply on orders containing special laminates. Contact the product modification team for questions or additional information regarding special laminates and pricing.

Color Match
KI offers the additional option of color matching paint, polypropylene, or wood stain through Product Modification Requests. Contact customer service for details.

SPECIAL SERVICES

Special Carton Marking
With specially marked information N/C

Shipping
Ships **knocked down, FOB Bonduel, WI 54107, freight prepaid.** Freight class 125.

Specifications and prices are subject to change without prior notice.

MyPlace™ Pillar™ Tables

Rectangular - 36" High, 18" and 24" Deep

MyPlace™ Pillar™ Tables

Rectangular - 36" High, 18" and 24" Deep

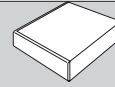

74P Edge (74P)
\$ 834

A x B	MODEL NUMBER										Approx. Packaged Weight	74P Edge (74P)	Laminate Grade 2 add to list price	Laminate Grade 3 add to list price	Steel Modesty Panel add to list price	Laminate Modesty Panel add to list price
	Basic Model	Edge Style	Power Option	Modesty Panel	Edge Color	Surface Finish	Paint Color	Base	Grommet/Module Color	Cord (feet)						
18 x 48"	PLRM1848H36	<input type="checkbox"/>	<input type="checkbox"/>	<input type="checkbox"/>	<input type="checkbox"/>	<input type="checkbox"/>	<input type="checkbox"/>	<input type="checkbox"/>	<input type="checkbox"/>	<input type="checkbox"/>	0.00#	\$ 834	\$ 19	\$ 120	\$ 286	\$ 351
24 x 48"	PLRM2448H36	<input type="checkbox"/>	<input type="checkbox"/>	<input type="checkbox"/>	<input type="checkbox"/>	<input type="checkbox"/>	<input type="checkbox"/>	<input type="checkbox"/>	<input type="checkbox"/>	<input type="checkbox"/>	0.00#	\$ 880	\$ 19	\$ 120	\$ 286	\$ 351

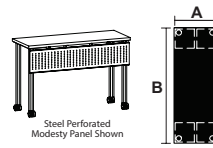

- PLRM
Rectangular Tables - 18"D
- Tables are designed for maximum leg spacing
 - Glides and casters are not interchangeable without changing the height of the table
 - Vertical and horizontal wire management are included automatically when power options are specified
 - Ganger kit with 2 ganging hooks included
 - Post Leg at 36" high

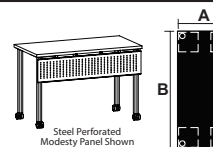

- PLRM
Rectangular Tables - 24"D
- Tables are designed for maximum leg spacing
 - Glides and casters are not interchangeable without changing the height of the table
 - Vertical and horizontal wire management are included automatically when power options are specified
 - Ganger kit with 2 ganging hooks included
 - Post Leg at 36" high

A B C D E F G H I J

HOW TO ORDER

- Indicate the following information on order form:
1. Quantity of each item.
 2. Model number, including options. See "How To Build a Model Number".
 3. Any special service required.

Note: • The indicates that a choice is required.
• The absence of the indicates that no choice is required.
• Alpha-numeric characters in place of indicate that no other alternatives are available.

HOW TO BUILD A MODEL NUMBER

- A** Select basic model.
74P - 74P edge
- B** Select edge style.
74P - 74P edge
- C** Select power option.
NNN - No grommets, power, wire management/No cutouts
WMO - Wire management only-no cutouts; add \$70
MD1 - Module, Dean in-surface w/USB-A/C (1); add \$375
MB1 - Module, Dubbel under-surface w/ dual USB-A/C (1); add \$280
MA1 - Module, Nacre pop-up w/USB-A/C (1); add \$445
MO1 - Module, Node in-surface w/USB-A/C (1); add \$280
GA1 - Grommet, Nacre (1); add \$222
GD1 - Grommet, Dean (1); add \$222
GO1 - Grommet, Node (1); add \$153
CORD LENGTH: 9' or 15' is optional on all module options.

WIRE MANAGEMENT: All options except NNN include vertical and horizontal wire management.

- D** Select modesty panel.
NMP - No modesty panel
SMP - Perforated steel modesty panel
LMP - Laminated modesty panel
See pricing column for full modesty panel upcharge.
- E** Select edge color.
Refer to the **Product Color Options** page in this price list.
- F** Select surface finish.
Refer to the **Product Color Options** page in this price list.
- G** Select paint finish.
Refer to the **Product Color Options** page in this price list.
If chrome is specified with a steel modesty panel, modesty panel will be flannel.

- H** Select base.
CST - Casters
GLD - Glides
Casters=2 locking/2 non-locking, black wheel, silver hub
- I** Select grommet/module color.
Refer to the **Product Color Options** page in this price list.
- J** Select Cord Length (feet).
9 - 9' cord length
15 - 15' cord length

FINISH INFORMATION

Additional Laminate Offering
KI offers laminates beyond those offered in the standard offering. Laminates that are currently available in the program can be viewed in KI product specification tools. Requests to add laminates to the program can be submitted via the product modification request process. Please note, requests to add laminates to the program must include the laminate manufacturer's name, color/pattern number, and finish code. Edge options are limited to standard edge colors. If a matching edge is required, this will need to be requested through the product modification request process and may be subject to additional costs. Due to varying manufacturing processes and quality issues with some laminates, some requests may be denied. Extended lead times and minimum order quantities may apply on orders containing special laminates. Contact the product modification team for questions or additional information regarding special laminates and pricing.

Color Match

KI offers the additional option of color matching paint, polypropylene, or wood stain through Product Modification Requests. Contact customer service for details.

SPECIAL SERVICES

Special Carton Marking
With specially marked information N/C

Shipping
Ships **knocked down, FOB Bonduel, WI 54107, freight prepaid.** Freight class 125.

Specifications and prices are subject to change without prior notice.

MyPlace™ Pillar™ Tables

Rectangular - 42" High, 18" and 24" Deep

MyPlace™ Pillar™ Tables

Rectangular - 42" High, 18" and 24" Deep

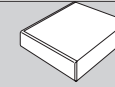

74P Edge (74P)
\$ 877

A x B	MODEL NUMBER										Approx. Packaged Weight	74P Edge (74P)	Laminate Grade 2 add to list price	Laminate Grade 3 add to list price	Steel Modesty Panel add to list price	Laminate Modesty Panel add to list price
	Basic Model	Edge Style	Power Option	Modesty Panel	Edge Color	Surface Finish	Paint Color	Base	Grommet/Module Color	Cord (feet)						
18 x 48"	PLRM1848H42	<input type="checkbox"/>	<input type="checkbox"/>	<input type="checkbox"/>	<input type="checkbox"/>	<input type="checkbox"/>	<input type="checkbox"/>	<input type="checkbox"/>	<input type="checkbox"/>	<input type="checkbox"/>	0.00#	\$ 877	\$ 19	\$ 120	\$ 286	\$ 351
24 x 48"	PLRM2448H42	<input type="checkbox"/>	<input type="checkbox"/>	<input type="checkbox"/>	<input type="checkbox"/>	<input type="checkbox"/>	<input type="checkbox"/>	<input type="checkbox"/>	<input type="checkbox"/>	<input type="checkbox"/>	0.00#	\$ 917	\$ 19	\$ 120	\$ 286	\$ 351

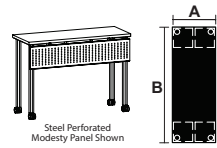

PLRM

Rectangular Tables - 18"D

- Tables are designed for maximum leg spacing
- Glides and casters are not interchangeable without changing the height of the table
- Vertical and horizontal wire management are included automatically when power options are specified
- Ganger kit with 2 ganging hooks included
- Post Leg at 42" high

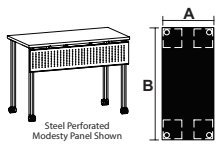

PLRM

Rectangular Tables - 24"D

- Tables are designed for maximum leg spacing
- Glides and casters are not interchangeable without changing the height of the table
- Vertical and horizontal wire management are included automatically when power options are specified
- Ganger kit with 2 ganging hooks included
- Post Leg at 42" high

A **B** **C** **D** **E** **F** **G** **H** **I** **J**

HOW TO ORDER

- Indicate the following information on order form:
- Quantity of each item.
 - Model number, including options. See "How To Build a Model Number".
 - Any special service required.

Note: • The indicates that a choice is required.
• The absence of the indicates that no choice is required.
• Alpha-numeric characters in place of indicate that no other alternatives are available.

HOW TO BUILD A MODEL NUMBER

- A** Select basic model.
B Select edge style.
C Select power option.
D Select modesty panel.
E Select edge color.
F Select surface finish.
G Select paint finish.

WIRE MANAGEMENT: All options except NNN include vertical and horizontal wire management.

- H** Select base.
I Select grommet/module color.
J Select Cord Length (feet).

- CST** - Casters
GLD - Glides
Casters=2 locking/2 non-locking, black wheel, silver hub
- 9** - 9' cord length
15 - 15' cord length

FINISH INFORMATION

Additional Laminate Offering

KI offers laminates beyond those offered in the standard offering. Laminates that are currently available in the program can be viewed in KI product specification tools. Requests to add laminates to the program can be submitted via the product modification request process. Please note, requests to add laminates to the program must include the laminate manufacturer's name, color/pattern number, and finish code. Edge options are limited to standard edge colors. If a matching edge is required, this will need to be requested through the product modification request process and may be subject to additional costs. Due to varying manufacturing processes and quality issues with some laminates, some requests may be denied. Extended lead times and minimum order quantities may apply on orders containing special laminates. Contact the product modification team for questions or additional information regarding special laminates and pricing.

Color Match

KI offers the additional option of color matching paint, polypropylene, or wood stain through Product Modification Requests. Contact customer service for details.

SPECIAL SERVICES

Special Carton Marking

With specially marked information N/C

Shipping
Ships **knocked down, FOB Bonduel, WI 54107, freight prepaid.** Freight class 125.

Specifications and prices are subject to change without prior notice.

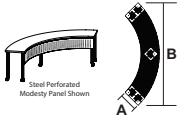

MODEL	A x B	MODEL NUMBER										Approx. Packaged Weight	74P Edge (74P)	Laminate Grade 2 add to list price	Laminate Grade 3 add to list price	Steel Modesty Panel add to list price	Laminate Modesty Panel add to list price
		Basic Model	Edge Style	Power Option	Modesty Panel	Edge Color	Surface Finish	Paint Color	Grommet/Module Color	Base							
 <p>PLPIC</p> <p>Inside Curve - 18"D</p> <ul style="list-style-type: none"> Two module/grommet per table unit Velcro wire managers, gangers and all electrical accessories (excluding infeed kits and table-to-table jumpers) are included Infeed kits and table-to-table jumpers ordered separately Tables are designed for maximum leg spacing Glides and casters are not interchangeable without changing the height of the table Ganger kit with 2 ganging hooks included Post Leg at 29" high 	18 x 102"	PLPIC18	<input type="checkbox"/>	<input type="checkbox"/>	<input type="checkbox"/>	<input type="checkbox"/>	<input type="checkbox"/>	<input type="checkbox"/>	<input type="checkbox"/>	<input type="checkbox"/>	<input type="checkbox"/>	0.00#	\$ 2115	\$ 105	\$ 709	\$ 364	\$ 2038
	<p>PLPIC</p> <p>Inside Curve - 24"D</p> <ul style="list-style-type: none"> Two module/grommet per table unit Velcro wire managers, gangers and all electrical accessories (excluding infeed kits and table-to-table jumpers) are included Infeed kits and table-to-table jumpers ordered separately Tables are designed for maximum leg spacing Glides and casters are not interchangeable without changing the height of the table Ganger kit with 2 ganging hooks included Post Leg at 29" high 	24 x 110"	PLPIC24	<input type="checkbox"/>	<input type="checkbox"/>	<input type="checkbox"/>	<input type="checkbox"/>	<input type="checkbox"/>	<input type="checkbox"/>	<input type="checkbox"/>	<input type="checkbox"/>	<input type="checkbox"/>	0.00#	\$ 2379	\$ 105	\$ 709	\$ 364

A B C D E F G H I

HOW TO ORDER

- Indicate the following information on order form:
- Quantity of each item.
 - Model number, including options. See "How To Build a Model Number".
 - Any special service required.

Note: • The indicates that a choice is required.

- The absence of the indicates that no choice is required.
- Alpha-numeric characters in place of indicate that no other alternatives are available.

HOW TO BUILD A MODEL NUMBER

- A** Select basic model.
- B** Select edge style.
74P - 74P edge
- C** Select power option.
PMD2 - Pattern modules, Dean in-surface (2) ; add \$1042
PMB2 - Pattern modules, Dubbel under-surface (2) ; add \$864
PMA2 - Pattern modules, Nacre pop-up (2) ; add \$1336
PMO2 - Pattern modules, Node in-surface (2) ; add \$814
- D** Select modesty panel.
NMP - No modesty panel
SMP - Perforated steel modesty panel
LMP - Laminate modesty panel
See pricing column for full modesty panel upcharge.
- E** Select edge color.

- Refer to the **Product Color Options** page in this price list.
- F** Select surface finish.
Refer to the **Product Color Options** page in this price list.
- G** Select paint finish.
Refer to the **Product Color Options** page in this price list.
If chrome is specified with a steel modesty panel, modesty panel will be flannel.
- H** Select grommet/module color.
Refer to the **Product Color Options** page in this price list.
- I** Select base.
CST - Casters
GLD - Glides
Casters=2 locking/2 non-locking, black wheel, silver hub

FINISH INFORMATION

Additional Laminate Offering
KI offers laminates beyond those offered in the standard offering. Laminates that are currently available in the program can be viewed in KI product specification tools. Requests to add laminates to the program can be submitted via the product modification request process. Please note, requests to add laminates to the program must include the laminate manufacturer's name, color/pattern number, and finish code. Edge options are limited to standard edge colors. If a matching edge is required, this will need to be requested through the product modification request process and may be subject to additional costs. Due to varying manufacturing processes and quality issues with some laminates, some requests may be denied. Extended lead times and minimum order quantities may apply on orders containing special laminates. Contact the product modification team for questions or additional information regarding special laminates and pricing.

Color Match

KI offers the additional option of color matching paint, polypropylene, or wood stain through Product Modification Requests. Contact customer service for details.

INFORMATION

Contact KI Customer Service for specific models that are UL listed.

SPECIAL SERVICES

Special Carton Marking
With specially marked information N/C

Shipping
Ships **knocked down, FOB Bonduel, WI 54107, freight prepaid.** Freight class 125.

Specifications and prices are subject to change without prior notice.

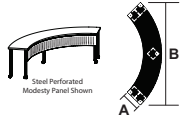

MODEL	A x B	MODEL NUMBER									Approx. Packaged Weight	74P Edge (74P)	Laminate Grade 2 add to list price	Laminate Grade 3 add to list price	Steel Modesty Panel add to list price	Laminate Modesty Panel add to list price
		Basic Model	Edge Style	Power Option	Modesty Panel	Edge Color	Surface Finish	Paint Color	Grommet/Module Color	Base						
 <p>PLPIC</p> <p>Inside Curve - 18"D</p> <ul style="list-style-type: none"> • Velcro wire managers, gangers and all electrical accessories (excluding infeed kits and table-to-table jumpers) are included • Infeed kits and table-to-table jumpers ordered separately • Tables are designed for maximum leg spacing • Glides and casters are not interchangeable without changing the height of the table • Ganger kit with 2 ganging hooks included • Post Leg at 36" high 	18 x 102"	PLPIC18H36	<input type="checkbox"/>	<input type="checkbox"/>	<input type="checkbox"/>	<input type="checkbox"/>	<input type="checkbox"/>	<input type="checkbox"/>	<input type="checkbox"/>	<input type="checkbox"/>	0.00#	\$ 2168	\$ 105	\$ 709	\$ 364	\$ 2038
	<p>PLPIC</p> <p>Inside Curve - 24"D</p> <ul style="list-style-type: none"> • Velcro wire managers, gangers and all electrical accessories (excluding infeed kits and table-to-table jumpers) are included • Infeed kits and table-to-table jumpers ordered separately • Tables are designed for maximum leg spacing • Glides and casters are not interchangeable without changing the height of the table • Ganger kit with 2 ganging hooks included • Post Leg at 36" high 	24 x 110"	PLPIC24H36	<input type="checkbox"/>	<input type="checkbox"/>	<input type="checkbox"/>	<input type="checkbox"/>	<input type="checkbox"/>	<input type="checkbox"/>	<input type="checkbox"/>	<input type="checkbox"/>	0.00#	\$ 2495	\$ 105	\$ 709	\$ 364

A B C D E F G H I

HOW TO ORDER

- Indicate the following information on order form:
1. Quantity of each item.
 2. Model number, including options. See "How to Build a Model Number".
 3. Any special service required.

Note: • The indicates that a choice is required.

- The absence of the indicates that no choice is required.
- Alpha-numeric characters in place of indicate that no other alternatives are available.

HOW TO BUILD A MODEL NUMBER

- A** Select basic model.
- B** Select edge style.
74P - 74P edge
- C** Select power option.
PMD2 - Pattern modules, Dean in-surface (2) ; add \$1042
PMB2 - Pattern modules, Dubbel under-surface (2) ; add \$864
PMA2 - Pattern modules, Nacre pop-up (2) ; add \$1336
PMO2 - Pattern modules, Node in-surface (2) ; add \$814
- D** Select modesty panel.
NMP - No modesty panel
SMP - Perforated steel modesty panel
LMP - Laminate modesty panel
See pricing column for full modesty panel upcharge.
- E** Select edge color.

- Refer to the **Product Color Options** page in this price list.
- F** Select surface finish.
Refer to the **Product Color Options** page in this price list.
- G** Select paint finish.
Refer to the **Product Color Options** page in this price list.
If chrome is specified with a steel modesty panel, modesty panel will be flannel.
- H** Select grommet/module color.
Refer to the **Product Color Options** page in this price list.
- I** Select base.
CST - Casters
GLD - Glides
Casters=2 locking/2 non-locking, black wheel, silver hub

FINISH INFORMATION

Additional Laminate Offering
KI offers laminates beyond those offered in the standard offering. Laminates that are currently available in the program can be viewed in KI product specification tools. Requests to add laminates to the program can be submitted via the product modification request process. Please note, requests to add laminates to the program must include the laminate manufacturer's name, color/pattern number, and finish code. Edge options are limited to standard edge colors. If a matching edge is required, this will need to be requested through the product modification request process and may be subject to additional costs. Due to varying manufacturing processes and quality issues with some laminates, some requests may be denied. Extended lead times and minimum order quantities may apply on orders containing special laminates. Contact the product modification team for questions or additional information regarding special laminates and pricing.

Color Match

KI offers the additional option of color matching paint, polypropylene, or wood stain through Product Modification Requests. Contact customer service for details.

INFORMATION

Contact KI Customer Service for specific models that are UL listed.

SPECIAL SERVICES

Special Carton Marking

With specially marked information N/C

Shipping
Ships **knocked down, FOB Bonduel, WI 54107, freight prepaid.** Freight class 125.

Specifications and prices are subject to change without prior notice.

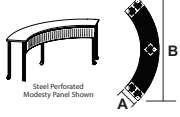

MODEL	A x B	MODEL NUMBER									Approx. Packaged Weight	74P Edge (74P)	Laminate Grade 2 add to list price	Laminate Grade 3 add to list price	Steel Modesty Panel add to list price	Laminate Modesty Panel add to list price	
		Basic Model	Edge Style	Power Option	Modesty Panel	Edge Color	Surface Finish	Paint Color	Grommet/Module Color	Base							
 <p>PLPIC</p> <p>Inside Curve - 18"D</p> <ul style="list-style-type: none"> • Velcro wire managers, gangers and all electrical accessories (excluding infeed kits and table-to-table jumpers) are included • Infeed kits and table-to-table jumpers ordered separately • Tables are designed for maximum leg spacing • Glides and casters are not interchangeable without changing the height of the table • Ganger kit with 2 ganging hooks included • Post Leg at 42" high 	18 x 102"	PLPIC18H42	<input type="checkbox"/>	<input type="checkbox"/>	<input type="checkbox"/>	<input type="checkbox"/>	<input type="checkbox"/>	<input type="checkbox"/>	<input type="checkbox"/>	<input type="checkbox"/>	0.00#	\$ 2221	\$ 105	\$ 709	\$ 364	\$ 2038	
	<p>PLPIC</p> <p>Inside Curve - 24"D</p> <ul style="list-style-type: none"> • Velcro wire managers, gangers and all electrical accessories (excluding infeed kits and table-to-table jumpers) are included • Infeed kits and table-to-table jumpers ordered separately • Tables are designed for maximum leg spacing • Glides and casters are not interchangeable without changing the height of the table • Ganger kit with 2 ganging hooks included • Post Leg at 42" high 	24 x 110"	PLPIC24H42	<input type="checkbox"/>	<input type="checkbox"/>	<input type="checkbox"/>	<input type="checkbox"/>	<input type="checkbox"/>	<input type="checkbox"/>	<input type="checkbox"/>	<input type="checkbox"/>	0.00#	\$ 2485	\$ 105	\$ 709	\$ 364	\$ 2038
		A	B	C	D	E	F	G	H	I							

HOW TO ORDER

- Indicate the following information on order form:
1. Quantity of each item.
 2. Model number, including options. See "How to Build a Model Number".
 3. Any special service required.

Note: • The indicates that a choice is required.
 • The absence of the indicates that no choice is required.
 • Alpha-numeric characters in place of indicate that no other alternatives are available.

HOW TO BUILD A MODEL NUMBER

- A** Select basic model.
- B** Select edge style.
 74P - 74P edge
- C** Select power option.
 PMD2 - Pattern modules, Dean in-surface (2) ; add \$1042
 PMB2 - Pattern modules, Dubbel under-surface (2) ; add \$864
 PMA2 - Pattern modules, Nacre pop-up (2) ; add \$1336
 PMO2 - Pattern modules, Node in-surface (2) ; add \$814
- D** Select modesty panel.
 NMP - No modesty panel
 SMP - Perforated steel modesty panel
 LMP - Laminate modesty panel
 See pricing column for full modesty panel upcharge.
- E** Select edge color.

- F** Select surface finish.
 Refer to the **Product Color Options** page in this price list.
- G** Select paint finish.
 Refer to the **Product Color Options** page in this price list.
 If chrome is specified with a steel modesty panel, modesty panel will be flannel.
- H** Select grommet/module color.
 Refer to the **Product Color Options** page in this price list.
- I** Select base.
 CST - Casters
 GLD - Glides
 Casters=2 locking/2 non-locking, black wheel, silver hub

FINISH INFORMATION

Additional Laminate Offering
 KI offers laminates beyond those offered in the standard offering. Laminates that are currently available in the program can be viewed in KI product specification tools. Requests to add laminates to the program can be submitted via the product modification request process. Please note, requests to add laminates to the program must include the laminate manufacturer's name, color/pattern number, and finish code. Edge options are limited to standard edge colors. If a matching edge is required, this will need to be requested through the product modification request process and may be subject to additional costs. Due to varying manufacturing processes and quality issues with some laminates, some requests may be denied. Extended lead times and minimum order quantities may apply on orders containing special laminates. Contact the product modification team for questions or additional information regarding special laminates and pricing.

Color Match

KI offers the additional option of color matching paint, polypropylene, or wood stain through Product Modification Requests. Contact customer service for details.

INFORMATION

Contact KI Customer Service for specific models that are UL listed.

SPECIAL SERVICES

Special Carton Marking

With specially marked information N/C

Shipping
 Ships **knocked down, FOB Bonduel, WI 54107, freight prepaid.** Freight class 125.

Specifications and prices are subject to change without prior notice.

MyPlace™ Pillar™ Tables

Rectangular - 29" High w/Single Circuit, 18" and 24" Deep



MyPlace™ Pillar™ Tables

Rectangular - 29" High w/Single Circuit, 18" and 24" Deep

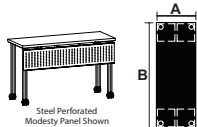
MODEL	A x B	MODEL NUMBER									Approx. Packaged Weight	74P Edge (74P)	Laminate Grade 2 add to list price	Laminate Grade 3 add to list price	Steel Modesty Panel add to list price	Laminate Modesty Panel add to list price
		Basic Model	Edge Style	Power Option	Modesty Panel	Edge Color	Surface Finish	Paint Color	Grommet/Module Color	Base						
 <p>Steel Perforated Modesty Panel Shown</p> <p>PLPRM</p> <p>Rectangular Tables - 18"D</p> <ul style="list-style-type: none"> • Velcro wire managers, gangers and all electrical accessories (excluding infeed kits and table-to-table jumpers) are included • Infeed kits and table-to-table jumpers ordered separately • Tables are designed for maximum leg spacing • Glides and casters are not interchangeable without changing the height of the table • Ganger kit with 2 ganging hooks included • Post Leg at 29" high 	18 x 48"	PLPRM1848	<input type="checkbox"/>	<input type="checkbox"/>	<input type="checkbox"/>	<input type="checkbox"/>	<input type="checkbox"/>	0.00#	\$ 794	\$ 19	\$ 120	\$ 286	\$ 351			
	<p>PLPRM</p> <p>Rectangular Tables - 24"D</p> <ul style="list-style-type: none"> • Velcro wire managers, gangers and all electrical accessories (excluding infeed kits and table-to-table jumpers) are included • Infeed kits and table-to-table jumpers ordered separately • Tables are designed for maximum leg spacing • Glides and casters are not interchangeable without changing the height of the table • Ganger kit with 2 ganging hooks included • Post Leg at 29" high 	24 x 48"	PLPRM2448	<input type="checkbox"/>	<input type="checkbox"/>	<input type="checkbox"/>	<input type="checkbox"/>	<input type="checkbox"/>	0.00#	\$ 845	\$ 19	\$ 120	\$ 286	\$ 351		

A B C D E F G H I

HOW TO ORDER

- Indicate the following information on order form:
1. Quantity of each item.
 2. Model number, including options. See "How to Build a Model Number".
 3. Any special service required.

Note: • The indicates that a choice is required.
 • The absence of the indicates that no choice is required.
 • Alpha-numeric characters in place of indicate that no other alternatives are available.

HOW TO BUILD A MODEL NUMBER

- A** Select basic model.
- B** Select edge style.
74P - 74P edge
- C** Select power option.
PMD1 - Pattern module, Dean in-surface (1) ; add \$520
PMB1 - Pattern module, Dubbel under-surface (1) ; add \$432
PMA1 - Pattern module, Nacre pop-up (1) ; add \$700
PMO1 - Pattern module, Node in-surface (1) ; add \$407
- D** Select modesty panel.
NMP - No modesty panel
SMP - Perforated steel modesty panel
LMP - Laminate modesty panel
 See pricing column for full modesty panel upcharge.
- E** Select edge color.

- Refer to the **Product Color Options** page in this price list.
- F** Select surface finish.
 Refer to the **Product Color Options** page in this price list.
- G** Select paint finish.
 Refer to the **Product Color Options** page in this price list.
 If chrome is specified with a steel modesty panel, modesty panel will be flannel.
- H** Select grommet/module color.
 Refer to the **Product Color Options** page in this price list.
- I** Select base.
CST - Casters
GLD - Glides
 Casters=2 locking/2 non-locking, black wheel, silver hub

FINISH INFORMATION

Additional Laminate Offering
 KI offers laminates beyond those offered in the standard offering. Laminates that are currently available in the program can be viewed in KI product specification tools. Requests to add laminates to the program can be submitted via the product modification request process. Please note, requests to add laminates to the program must include the laminate manufacturer's name, color/pattern number, and finish code. Edge options are limited to standard edge colors. If a matching edge is required, this will need to be requested through the product modification request process and may be subject to additional costs. Due to varying manufacturing processes and quality issues with some laminates, some requests may be denied. Extended lead times and minimum order quantities may apply on orders containing special laminates. Contact the product modification team for questions or additional information regarding special laminates and pricing.

Color Match

KI offers the additional option of color matching paint, polypropylene, or wood stain through Product Modification Requests. Contact customer service for details.

INFORMATION

Contact KI Customer Service for specific models that are UL listed.

SPECIAL SERVICES

Special Carton Marking

With specially marked information N/C

Shipping
 Ships **knocked down, FOB Bonduel, WI 54107, freight prepaid.** Freight class 125.

Specifications and prices are subject to change without prior notice.

MyPlace™ Pillar™ Tables

Rectangular - 36" High w/Single Circuit, 18" and 24" Deep

MyPlace™ Pillar™ Tables

Rectangular - 36" High w/Single Circuit, 18" and 24" Deep

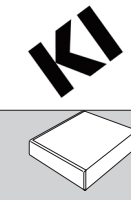

A x B	MODEL NUMBER										Approx. Packaged Weight	74P Edge (74P)		Laminate Grade 2 add to list price	Laminate Grade 3 add to list price	Steel Modesty Panel add to list price	Laminate Modesty Panel add to list price
	Basic Model	Edge Style	Power Option	Modesty Panel	Edge Color	Surface Finish	Paint Color	Grommet/Module Color	Base								
18 x 48"	PLPRM1848H36	<input type="checkbox"/>	<input type="checkbox"/>	<input type="checkbox"/>	<input type="checkbox"/>	<input type="checkbox"/>	<input type="checkbox"/>	<input type="checkbox"/>	<input type="checkbox"/>	<input type="checkbox"/>	0.00#	\$ 834		\$ 19	\$ 120	\$ 286	\$ 351
24 x 48"	PLPRM2448H36	<input type="checkbox"/>	<input type="checkbox"/>	<input type="checkbox"/>	<input type="checkbox"/>	<input type="checkbox"/>	<input type="checkbox"/>	<input type="checkbox"/>	<input type="checkbox"/>	<input type="checkbox"/>	0.00#	\$ 880		\$ 19	\$ 120	\$ 286	\$ 351

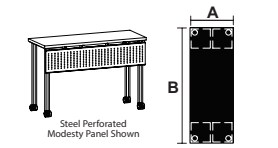

- PLPRM
Rectangular Tables - 18"D
- Velcro wire managers, gangers and all electrical accessories (excluding infeed kits and table-to-table jumpers) are included
 - Infeed kits and table-to-table jumpers ordered separately
 - Tables are designed for maximum leg spacing
 - Glides and casters are not interchangeable without changing the height of the table
 - Ganger kit with 2 ganging hooks included
 - Post Leg at 36" high

- PLPRM
Rectangular Tables - 24"D
- Velcro wire managers, gangers and all electrical accessories (excluding infeed kits and table-to-table jumpers) are included
 - Infeed kits and table-to-table jumpers ordered separately
 - Tables are designed for maximum leg spacing
 - Glides and casters are not interchangeable without changing the height of the table
 - Ganger kit with 2 ganging hooks included
 - Post Leg at 36" high

A **B** **C** **D** **E** **F** **G** **H** **I**

HOW TO ORDER

- Indicate the following information on order form:
1. Quantity of each item.
 2. Model number, including options. See "How To Build a Model Number".
 3. Any special service required.

Note: • The indicates that a choice is required.
• The absence of the indicates that no choice is required.
• Alpha-numeric characters in place of indicate that no other alternatives are available.

HOW TO BUILD A MODEL NUMBER

- A** Select basic model.
- B** Select edge style.
74P - 74P edge
- C** Select power option.
PMD1 - Pattern module, Dean in-surface (1) ; add \$520
PMB1 - Pattern module, Dubbel under-surface (1) ; add \$432
PMA1 - Pattern module, Nacre pop-up (1) ; add \$700
PMO1 - Pattern module, Node in-surface (1) ; add \$407
- D** Select modesty panel.
NMP - No modesty panel
SMP - Perforated steel modesty panel
LMP - Laminate modesty panel
See pricing column for full modesty panel upcharge.
- E** Select edge color.

- Refer to the **Product Color Options** page in this price list.
- F** Select surface finish.
Refer to the **Product Color Options** page in this price list.
- G** Select paint finish.
Refer to the **Product Color Options** page in this price list.
If chrome is specified with a steel modesty panel, modesty panel will be flannel.
- H** Select grommet/module color.
Refer to the **Product Color Options** page in this price list.
- I** Select base.
CST - Casters
GLD - Glides
Casters=2 locking/2 non-locking, black wheel, silver hub

FINISH INFORMATION

Additional Laminate Offering
KI offers laminates beyond those offered in the standard offering. Laminates that are currently available in the program can be viewed in KI product specification tools. Requests to add laminates to the program can be submitted via the product modification request process. Please note, requests to add laminates to the program must include the laminate manufacturer's name, color/pattern number, and finish code. Edge options are limited to standard edge colors. If a matching edge is required, this will need to be requested through the product modification request process and may be subject to additional costs. Due to varying manufacturing processes and quality issues with some laminates, some requests may be denied. Extended lead times and minimum order quantities may apply on orders containing special laminates. Contact the product modification team for questions or additional information regarding special laminates and pricing.

Color Match

KI offers the additional option of color matching paint, polypropylene, or wood stain through Product Modification Requests. Contact customer service for details.

INFORMATION

Contact KI Customer Service for specific models that are UL listed.

SPECIAL SERVICES

Special Carton Marking
With specially marked information N/C

Shipping
Ships **knocked down, FOB Bonduel, WI 54107, freight prepaid.** Freight class 125.

Specifications and prices are subject to change without prior notice.

MyPlace™ Pillar™ Tables

Rectangular - 42" High w/Single Circuit, 18" and 24" Deep

MyPlace™ Pillar™ Tables

Rectangular - 42" High w/Single Circuit, 18" and 24" Deep

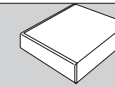

A x B	MODEL NUMBER										Approx. Packaged Weight	74P Edge (74P)		Laminate Grade 2 add to list price	Laminate Grade 3 add to list price	Steel Modesty Panel add to list price	Laminate Modesty Panel add to list price
	Basic Model	Edge Style	Power Option	Modesty Panel	Edge Color	Surface Finish	Paint Color	Grommet/Module Color	Base								
18 x 48"	PLPRM1848H42	<input type="checkbox"/>	<input type="checkbox"/>	<input type="checkbox"/>	<input type="checkbox"/>	<input type="checkbox"/>	<input type="checkbox"/>	<input type="checkbox"/>	<input type="checkbox"/>	<input type="checkbox"/>	0.00#	\$ 877		\$ 19	\$ 120	\$ 286	\$ 351
24 x 48"	PLPRM2448H42	<input type="checkbox"/>	<input type="checkbox"/>	<input type="checkbox"/>	<input type="checkbox"/>	<input type="checkbox"/>	<input type="checkbox"/>	<input type="checkbox"/>	<input type="checkbox"/>	<input type="checkbox"/>	0.00#	\$ 917		\$ 19	\$ 120	\$ 286	\$ 351

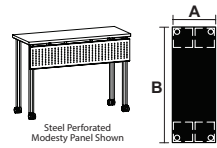

- PLPRM
Rectangular Tables - 18"D
- Velcro wire managers, gangers and all electrical accessories (excluding infeed kits and table-to-table jumpers) are included
 - Infeed kits and table-to-table jumpers ordered separately
 - Tables are designed for maximum leg spacing
 - Glides and casters are not interchangeable without changing the height of the table
 - Ganger kit with 2 ganging hooks included
 - Post Leg at 42" high

- PLPRM
Rectangular Tables - 24"D
- Velcro wire managers, gangers and all electrical accessories (excluding infeed kits and table-to-table jumpers) are included
 - Infeed kits and table-to-table jumpers ordered separately
 - Tables are designed for maximum leg spacing
 - Glides and casters are not interchangeable without changing the height of the table
 - Ganger kit with 2 ganging hooks included
 - Post Leg at 42" high

A **B** **C** **D** **E** **F** **G** **H** **I**

HOW TO ORDER

- Indicate the following information on order form:
1. Quantity of each item.
 2. Model number, including options. See "How To Build a Model Number".
 3. Any special service required.

Note: • The indicates that a choice is required.
• The absence of the indicates that no choice is required.
• Alpha-numeric characters in place of indicate that no other alternatives are available.

HOW TO BUILD A MODEL NUMBER

- A** Select basic model.
- B** Select edge style.
74P - 74P edge
- C** Select power option.
PMD1 - Pattern module, Dean in-surface (1) ; add \$520
PMB1 - Pattern module, Dubbel under-surface (1) ; add \$432
PMA1 - Pattern module, Nacre pop-up (1) ; add \$700
PMO1 - Pattern module, Node in-surface (1) ; add \$407
- D** Select modesty panel.
NMP - No modesty panel
SMP - Perforated steel modesty panel
LMP - Laminate modesty panel
See pricing column for full modesty panel upcharge.
- E** Select edge color.

- Refer to the **Product Color Options** page in this price list.
- F** Select surface finish.
Refer to the **Product Color Options** page in this price list.
- G** Select paint finish.
Refer to the **Product Color Options** page in this price list.
If chrome is specified with a steel modesty panel, modesty panel will be flannel.
- H** Select grommet/module color.
Refer to the **Product Color Options** page in this price list.
- I** Select base.
CST - Casters
GLD - Glides
Casters=2 locking/2 non-locking, black wheel, silver hub

FINISH INFORMATION

Additional Laminate Offering
KI offers laminates beyond those offered in the standard offering. Laminates that are currently available in the program can be viewed in KI product specification tools. Requests to add laminates to the program can be submitted via the product modification request process. Please note, requests to add laminates to the program must include the laminate manufacturer's name, color/pattern number, and finish code. Edge options are limited to standard edge colors. If a matching edge is required, this will need to be requested through the product modification request process and may be subject to additional costs. Due to varying manufacturing processes and quality issues with some laminates, some requests may be denied. Extended lead times and minimum order quantities may apply on orders containing special laminates. Contact the product modification team for questions or additional information regarding special laminates and pricing.

Color Match

KI offers the additional option of color matching paint, polypropylene, or wood stain through Product Modification Requests. Contact customer service for details.

INFORMATION

Contact KI Customer Service for specific models that are UL listed.

SPECIAL SERVICES

Special Carton Marking

With specially marked information N/C

Shipping
Ships **knocked down, FOB Bonduel, WI 54107, freight prepaid.** Freight class 125.

Specifications and prices are subject to change without prior notice.



1330 BELLEVUE STREET
GREEN BAY, WI 54302
800.424.2432 / KI.COM

KI is a trusted expert for furniture and wall systems around the globe.
USA | CANADA | MEXICO | UK | EUROPE | ASIA | MIDDLE EAST
© 2026 Krueger International, Inc. All Rights Reserved.