



# SOLTÍCE<sup>®</sup> METAL COLLECTION

---

PRICE LIST

EFFECTIVE MARCH 31, 2026  
800.424.2432



<b>Fabric Yardage Pricing</b>	3
<b>Ordering Customer's Own Material (C.O.M.) Upholstery</b>	
Information	4
<b>Soltice® Metal</b>	
Multiple Seating General Information	6
Multiple Seating Color Options	9
Multiple Seating	10
Multiple Seating - Three Seat Spanner	20
Multiple Seating Add-on	22
Lobby and Lounge Seating General Information	34
Lobby and Lounge Seating Color Options	36
Lobby and Lounge Seating	37
Occasional Tables General Information	40
Occasional Tables Color Options	41
Laminate Club Tables	42
Laminate Lamp Tables	43
Laminate Coffee & Console Tables	44
Veneer Club Tables	45
Veneer Lamp Tables	46
Veneer Coffee & Console Tables	47
Solid Surface Club Tables	48
Solid Surface Lamp Tables	49
Solid Surface Coffee & Console Tables	50



Yardage	Grade	List Price Per Yard
1	C	\$ 49
1	D	\$ 64
1	E	\$ 78
1	F	\$ 100
1	G	\$ 122
1	H	\$ 144
1	I	\$ 178
1	J	\$ 222
1	K	\$ 289
1	L	\$ 333
1	M	\$ 422



## Customer's Own Material ■

Specifications Form  
January 2023

### How to Specify

As a standard procedure, KI applies seating upholstery as swatched by the textile distributor. Reference distributor's website. Upholstery that is required to be applied differently than is swatched, will need a Product Modification Request written specifying the direction the upholstery is to be applied.

Seating upholstery requiring specific positioning of intricate patterns or patterns repeats on seats and backrests, will need a Product Modification Request written including a sketch noting the specific requirements, as in Diagram A.

C.O.M. must be supplied in continuous yardage.

Yardage requirements listed in price list are based on plain goods 54" wide. Fabrics less than 54" wide, or those requiring matching (stripes, plaids, prints, large patterns) will require additional yardage based on the fabric used and the item ordered. Consult matrix below for additional yardage needed.

**C.O.M. INCREASE MATRIX** (yardage matrix is also applicable to any reservations of KI Ingrade, Pallas, or K.O.M. upholsteries).

This table is a general guide.

FABRIC WIDTH	PLAIN FABRIC	UNDER 7"	8"-13"	14"-21"	22"-27"	28"-33"	34"-40"	41"-48"
	REPEAT	REPEAT	REPEAT	REPEAT	REPEAT	REPEAT	REPEAT	REPEAT
54"	0	20%	25%	30%	45%	55%	70%	80%
51"-53"	15%	25%	30%	35%	50%	60%	80%	90%
48"-50"	20%	30%	35%	40%	55%	65%	85%	95%
45"-47"	30%	45%	50%	55%	60%	80%	90%	100%
36"-44"	50%	65%	70%	75%	80%	100%	110%	120%

Fabric with double repeat: If using a fabric with a double repeat, please follow this formula: take the total amount of the larger and half of the smaller repeat; add together to find the correct overall repeat. Example: 10" vertical with 14" horizontal would be  $14 + \frac{10}{2} = 19$ .

If fabric comes in on multiple rolls, one additional yard per roll needs to be added to the yardage requirement.

Leather hides must be a minimum of 50 square feet of usable material. The outer edges cannot be calculated as square feet or yardage. To determine square footage, multiply unit yardage by 18 square feet to obtain the total square footage required per unit.

For exact production yardage requirements, call 1-800-424-2432, ext. 2707.

### Production

Customer's upholstery must be approved prior to acceptance for production.

After approval, a memo swatch of the C.O.M. from the textile distributor must accompany the order. KI assumes no responsibility for wear, defects, or performance of C.O.M. or K.O.M. upholstery.

C.O.M. not received into the appropriate facility 3 weeks prior to acknowledged delivery date may go on hold. See KI C.O.M.

Shipping Location listing for the correct facility address by product.

All C.O.M. must be labeled as follows:

1. Name and address
2. Your purchase order number
3. Our style number to which fabric is to be applied
4. Supplier name and fabric name, number, and color

ALL C.O.M. Shipments must be prepaid. Collect shipments will be refused.

### Testing

When KI requires testing, actual yardage to upholster one chair may be required. The C.O.M. Specialist will confirm model and fabric testing requirements when applicable.

Approved test samples will be applied to the order or will be held for 6 months. After 6 months, the sample will no longer be applied to your order. For all product testing, send fabric samples to the manufacturing facility. See KI C.O.M. Shipping Location listing for the correct facility address by product.

ALL C.O.M. Shipments must be prepaid. Collect shipments will be refused.

### Treated Materials

If C.O.M. requires processing such as a stain resistance treatment or acrylic backing, it may shrink. To prevent delays in delivery or back ordering due to shrinkage, please have your processor verify measurement after processing and assure adequate yardage shipped.

### Split Orders

If a portion of the shipment which does not require C.O.M. application is to be processed and shipped early, KI will enter the order immediately at your request. These split shipments are subject to minimum order changes.

### Excess Upholstery Material

KI will dispose of excess upholstery material at the time of shipment unless expressly requested to return it with the product shipment.

### Cancelled or Changed Orders

KI assumes no responsibility for extra C.O.M. due to a change of upholstery or cancellation of an order. If it the customer's responsibility to arrange for return of the material.

Contact the C.O.M. Specialist at 1-800-424-2432, ext. 2707, with questions or to request a split order

Diagram A

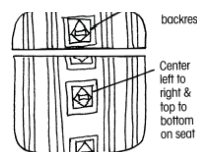



## C.O.M. SHIPPING LOCATION



<b>Architectural Walls</b>	<b>Panel Systems</b>	Impress Ultra ..... OM
Evoke..... MN	All Terrain..... KP	Intellect Wave ..... GB
Genius..... MN	Balance ..... MN	Jessa ..... HN
<b>Casegoods</b>	Universal ..... MN	Jubilee ..... VQ
Aristotle..... MN	Wireworks ..... MN	Katera..... GB
Likha..... MN	Unite..... MN	Kurv Benches..... HN
<b>Classroom Furniture</b>	<b>Residence Hall Furniture</b>	Learn2..... GB
Cogni ..... GB	RoomScape ..... MN	LimeLite..... GB
Intellect Wave ..... GB	<b>Screens</b>	Lyra ..... HN
Learn2..... GB	All Terrain..... KP	Medical & Laboratory Stools..... OM
Ruckus..... GB	Connection Zone..... BW	MyPlace ..... HN
<b>Desking</b>	Tributaire..... BW	MyWay ..... HN
700 Series ..... KP	True/Volition ..... KP	Oath ..... GB
Balance ..... MN	Genesis..... KP	Opt4..... GB
Genesis ..... MN	Tattoo..... MN	Pilot ..... OM
True ..... KP	Universal..... BW	Promenade ..... BW
Universal ..... MN	<b>Seating</b>	Ruckus..... GB
WorkZone ..... MN	600 Series..... BW	Sela ..... HN
<b>Files &amp; Storage</b>	Affina ..... HN	Sift ..... GB
700 Series..... GB	Altus ..... GB	Signia..... OM
Connection ..... BW	Apply ..... GB	Soltice Metal ..... HN
U-Series..... GB	Calida ..... HN	Soltice..... HN
Tattoo..... BW	Cascha ..... VT	Sonrisa ..... HN
<b>Fixed Seating</b>	Civara ..... VT	Strive..... GB
Concerto..... BW	Clamber ..... HN	Sway ..... BW
Single Pedestal ..... GB	Cogni ..... GB	Tattoo..... HN
Jury Base ..... GB	Diem ..... OM	Torsion-on-the-Go! ..... GB
Lancaster..... BW	Doni ..... GB	Torsion Air ..... GB
Sequence ..... GB	Gladly ..... VQ	Zeker ..... HN
University ..... GB	Grazie ..... GB	Zentori ..... VT
	Hub ..... HN	Zoetry ..... HN
	Impress ..... OM	

## KI C.O.M. Manufacturing Site Addresses:

<b>BW</b> KI Bonduel Attn: COM Storage 204 West South St. Bonduel, WI 54107	<b>HN</b> KI High Point Attn: COM Storage 217 Feld Avenue High Point, NC 27263	<b>MN</b> KI Manitowoc Attn: COM Storage 1400 S. 41st St. Manitowoc, WI 54220	<b>VQ</b> KI Attn: COM Fabrics 6892 Marlin Circle La Palma, CA 90623
<b>GB</b> KI Green Bay Attn: COM Storage 1687 Westminster Drive - Gate 3 Green Bay, WI 54302	<b>KP</b> KI Pembroke Attn: COM Storage 1000 Olympic Dr. Pembroke, Ontario K8A6X7	<b>OM</b> KI Attn: COM Storage 1110 S. Mildred Ave. Ontario, CA 91761	<b>VT</b> KI Attn: COM Storage 2803 South Taylor Drive Sheboygan, WI 53081



One Seat - Open Arm (SOMC)    Two Seat - Open Arm (SOMCC)    Three Seat - Open Arm (SOMCCC)    One Seat - Closed Arm (SPMC)    Two Seat - Closed Arm (SPMCC)    Three Seat - Closed Arm (SPMCCC)

General Dimensions						
Seat width	21"	21" each	21" each	21"	21" each	21" each
Seat depth	17-1/2"	17-1/2"	17-1/2"	17-1/2"	17-1/2"	17-1/2"
Seat height	19"	19"	19"	19"	19"	19"
Arm width	1-7/8"	1-7/8"	1-7/8"	1-7/8"	1-7/8"	1-7/8"
Arm height	27-1/2"	27-1/2"	27-1/2"	27-1/2"	27-1/2"	27-1/2"
Overall Dimensions						
Width	24-1/2"	47"	69-1/2"	24-1/2"	47"	69-1/2"
Depth	23-1/2"	23-1/2"	23-1/2"	23-1/2"	23-1/2"	23-1/2"
Height	33-13/16"	33-13/16"	33-13/16"	33-13/16"	33-13/16"	33-13/16"



Bariatric - Open Arm (SOMB)    Bariatric - Closed Arm (SPMB)    Loveseat - Open Arm (SOM33)    Loveseat - Closed Arm (SPM33)    Spanner - Open Arm (SOM3S)    Spanner - Closed Arm (SPM3S)

General Dimensions						
Seat width	30"	30"	41"	41"	66"	66"
Seat depth	17-1/2"	17-1/2"	17-1/2"	17-1/2"	17-1/2"	17-1/2"
Seat height	19"	19"	19"	19"	19"	19"
Arm width	1-7/8"	1-7/8"	1-7/8"	1-7/8"	1-7/8"	1-7/8"
Arm height	27-1/2"	27-1/2"	27-1/2"	27-1/2"	27-1/2"	27-1/2"
Overall Dimensions						
Width	33"	33"	44"	44"	69-1/2"	69-1/2"
Depth	23-1/2"	23-1/2"	23-1/2"	23-1/2"	23-1/2"	23-1/2"
Height	33-13/16"	33-13/16"	33-13/16"	33-13/16"	33-13/16"	33-13/16"

### Multiple Seating Chair Connection Brackets (Example)

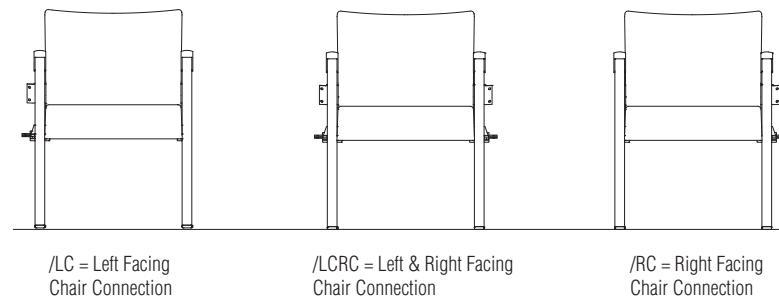

/LC = Left Facing  
Chair Connection

/LCRC = Left & Right Facing  
Chair Connection

/RC = Right Facing  
Chair Connection

### UPHOLSTERY INFORMATION

#### C.O.M. Fabric

For C.O.M. fabric sent to KI-High Point on multiple rolls, add an additional yard of fabric per roll to the yardage requirements. Multiple rolls have shorter pieces of fabric on them and do not allow nesting and stacking of the fabric to achieve the best yield as is done with one large roll. This results in yardage shortages and requests for additional fabric from the client, which can delay an order. For each roll that is sent, one yard needs to be added to one of the rolls, not separately.

#### Fabric Disclaimer

Fabric will be applied as swatched by the fabric manufacturer. Fabric that is required to be applied differently than is swatched will need a Product Modification Request written specifying the direction the fabric is to be applied.

### FINISH INFORMATION

#### Color Match

KI offers the additional option of color matching paint, polypropylene, or wood stain through Product Modification Requests. Contact Customer Service for details.

### INFORMATION

#### Warranty

Refer to KI Terms & Conditions document or visit [ki.com](http://ki.com)



	One Seat Add-on Open Arm (SOMACL/SOMACR)	Two Seat Add-on Open Arm (SOMACCL/SOMACCR)	Three Seat Add-on Open Arm (SOMACCL/SOMACCCR)	One Seat Add-on Closed Arm (SPMACL/SPMACR)	Two Seat Add-on Closed Arm (SPMACCL/SPMACCR)	Three Seat Add-on Closed Arm (SPMACCL/SPMACCCR)
<b>General Dimensions</b>						
Seat width	21"	21" each	21" each	21"	21" each	21" each
Seat depth	17-1/2"	17-1/2"	17-1/2"	17-1/2"	17-1/2"	17-1/2"
Seat height	19"	19"	19"	19"	19"	19"
Arm width	1-7/8"	1-7/8"	1-7/8"	1-7/8"	1-7/8"	1-7/8"
Arm height	27-1/2"	27-1/2"	27-1/2"	27-1/2"	27-1/2"	27-1/2"
<b>Overall Dimensions</b>						
Width	22-1/2"	45-1/2"	68"	22-1/2"	45-1/2"	68"
Depth	23-1/2"	23-1/2"	23-1/2"	23-1/2"	23-1/2"	23-1/2"
Height	33-13/16"	33-13/16"	33-13/16"	33-13/16"	33-13/16"	33-13/16"

#### UPHOLSTERY INFORMATION

##### C. O. M. Fabric

For C.O.M. fabric sent to KI-High Point on multiple rolls, add an additional yard of fabric per roll to the yardage requirements. Multiple rolls have shorter pieces of fabric on them and do not allow nesting and stacking of the fabric to achieve the best yield as is done with one large roll. This results in yardage shortages and requests for additional fabric from the client, which can delay an order. For each roll that is sent, one yard needs to be added to one of the rolls, not separately.

##### Fabric Disclaimer

Fabric will be applied as swatched by the fabric manufacturer. Fabric that is required to be applied differently than is swatched will need a Product Modification Request written specifying the direction the fabric is to be applied.

#### FINISH INFORMATION

##### Color Match

KI offers the additional option of color matching paint, polypropylene, or wood stain through Product Modification Requests. Contact Customer Service for details.

#### INFORMATION

##### Warranty

Refer to KI Terms & Conditions document or visit [ki.com](http://ki.com)



Multiple Seating (Open Arm/ Closed Arm)

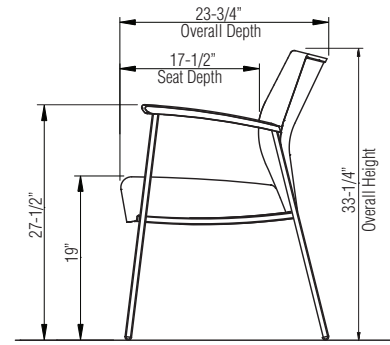

Multiple Seating - All Models

Left Facing Add On Multiple Seating (Open Arm/ Closed Arm)

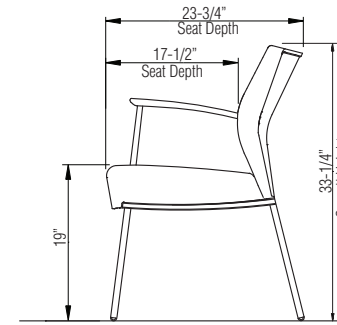

Add On Multiple Seating - All Models

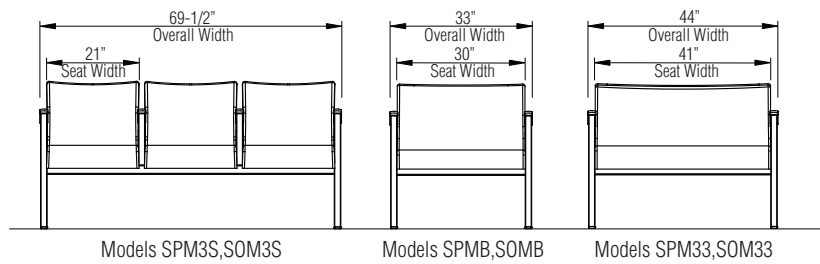
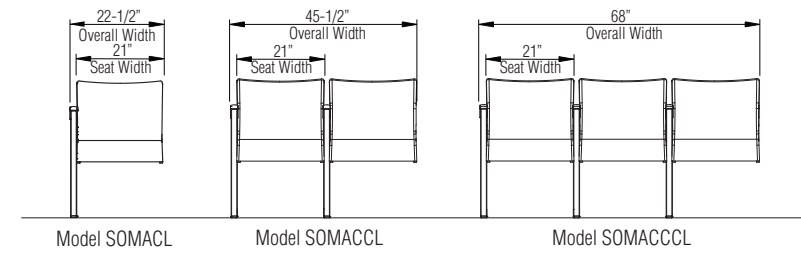
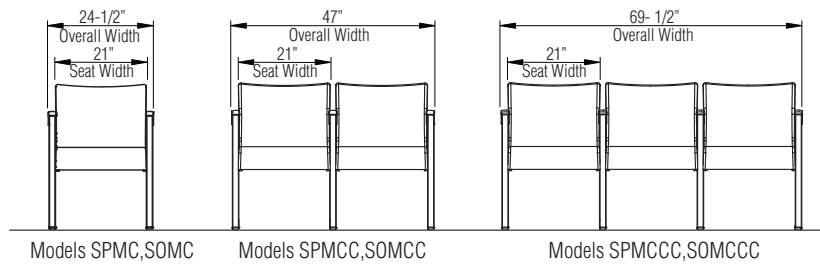

Right Facing Add On Multiple Seating (Open Arm/ Closed Arm)

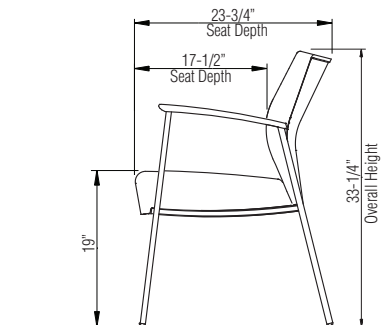

Add On Multiple Seating - All Models

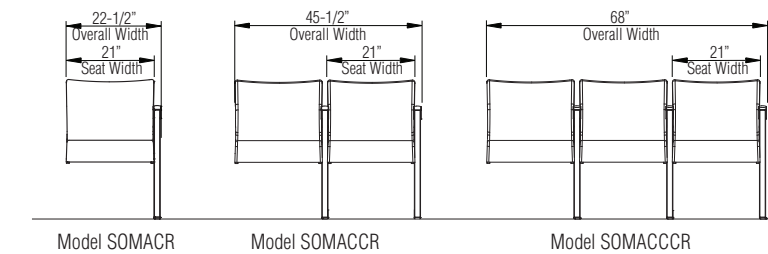



## Base Finish

Black	BL
Blue Grey	GR
Bronze Metallic	ZM
Cayenne	CY
Champagne Metallic	CM
Cool Grey	CG
Cottonwood	CO
Earthen Clay	EY
Espresso Metallic	EX
Everglade Shade	EV
Flannel	FN
Glitz Metallic	GZ
Hazy Jade	HJ
Honey Bee	HY
Light Tone	LG
Mardi Gras	MG
Misty Brown	MY
Nemo	NE
Nordic	ND
Poppy Red	PR
Purple Haze	PH
Rainforest	RQ
Raw Jasper	RJ
Rubber Ducky	RK
Sand	SA
Sky Blue	SK
Starlight Silver Metallic	SX
Surf's Up	SP
Tarragon	TQ
Twilight Shadow	TI
Ultra Blue	UB
Warm Grey	WG
Zesty Lime	ZL

## Wood Armcap Finish

Cherry Storm on Beech	BCX
Cinnamon on Beech	BCN
Cocoa on Beech	BCA
Eclipse Black on Beech	BEB
Florence Walnut on Beech	BFC
Kensington Maple on Maple	MMA
Monticello Maple on Beech	BMT
Natural on Beech	BNA
River Cherry on Beech	BRY

Kensington Maple requires an upcharge.

## Glide Color

Flannel (Dark Grey)	NGFN
Natural (Cream)	NGNT

## Finish Cards

View color swatches for items listed within this document.

[Paints](#)

[Wood/Veneer](#)

[Molded Edges](#)

[Hard Plastics](#)

[Plastics/Poly](#)

[Laminates](#)

[Edge Styles](#)

[Glass](#)

Certain options referenced may not be available on GSA Schedule.



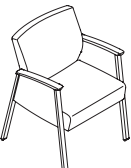
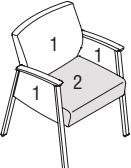

Features	MODEL NUMBER								Approx. Packaged Weight	Delivered Pricing	Moisture Barrier add to list price	
	Basic Model	Non-Contrast or Fabric Contrast 1	Fabric Contrast 2	Base Finish	Arm Cap	Wood Finish	Glide Color	Moist. Barrier				
 SMMC <b>One Seat (Closed Arm) Non-Contrast</b> • Non-contrast C.O.M = 2.25 yd	No Connector	SPMC/NC	<input type="checkbox"/> <input type="checkbox"/> <input type="checkbox"/> <input type="checkbox"/>		<input type="checkbox"/> <input type="checkbox"/>	<input type="checkbox"/> <input type="checkbox"/>	<input type="checkbox"/> <input type="checkbox"/>	<input type="checkbox"/> <input type="checkbox"/>	<input type="checkbox"/> <input type="checkbox"/>	55.00#	\$ 1790	\$ 240
	Left Facing Chair Connector	SPMCLC/NC	<input type="checkbox"/> <input type="checkbox"/> <input type="checkbox"/> <input type="checkbox"/>		<input type="checkbox"/> <input type="checkbox"/>	<input type="checkbox"/> <input type="checkbox"/>	<input type="checkbox"/> <input type="checkbox"/>	<input type="checkbox"/> <input type="checkbox"/>	<input type="checkbox"/> <input type="checkbox"/>	55.00#	1790	240
	Right Facing Chair Connector	SPMCRC/NC	<input type="checkbox"/> <input type="checkbox"/> <input type="checkbox"/> <input type="checkbox"/>		<input type="checkbox"/> <input type="checkbox"/>	<input type="checkbox"/> <input type="checkbox"/>	<input type="checkbox"/> <input type="checkbox"/>	<input type="checkbox"/> <input type="checkbox"/>	<input type="checkbox"/> <input type="checkbox"/>	55.00#	1790	240
	Left and Right Facing Chair Connector	SPMCLCRC/NC	<input type="checkbox"/> <input type="checkbox"/> <input type="checkbox"/> <input type="checkbox"/>		<input type="checkbox"/> <input type="checkbox"/>	<input type="checkbox"/> <input type="checkbox"/>	<input type="checkbox"/> <input type="checkbox"/>	<input type="checkbox"/> <input type="checkbox"/>	<input type="checkbox"/> <input type="checkbox"/>	55.00#	1790	240
 SMMC <b>One Seat (Closed Arm) Contrast</b> • 1 = Back and Arms (Fabric Contrast 1) C.O.M. = 1.75 yd • 2 = Seat (Fabric Contrast 2) C.O.M. = 1 yd	No Connector	SPMC/FC	<input type="checkbox"/> <input type="checkbox"/> <input type="checkbox"/> <input type="checkbox"/>	<input type="checkbox"/> <input type="checkbox"/> <input type="checkbox"/> <input type="checkbox"/>	<input type="checkbox"/> <input type="checkbox"/>	<input type="checkbox"/> <input type="checkbox"/>	<input type="checkbox"/> <input type="checkbox"/>	<input type="checkbox"/> <input type="checkbox"/>	<input type="checkbox"/> <input type="checkbox"/>	55.00#	\$ 1852	\$ 240
	Left Facing Chair Connector	SPMCLC/FC	<input type="checkbox"/> <input type="checkbox"/> <input type="checkbox"/> <input type="checkbox"/>	<input type="checkbox"/> <input type="checkbox"/> <input type="checkbox"/> <input type="checkbox"/>	<input type="checkbox"/> <input type="checkbox"/>	<input type="checkbox"/> <input type="checkbox"/>	<input type="checkbox"/> <input type="checkbox"/>	<input type="checkbox"/> <input type="checkbox"/>	<input type="checkbox"/> <input type="checkbox"/>	55.00#	1852	240
	Right Facing Chair Connector	SPMCRC/FC	<input type="checkbox"/> <input type="checkbox"/> <input type="checkbox"/> <input type="checkbox"/>	<input type="checkbox"/> <input type="checkbox"/> <input type="checkbox"/> <input type="checkbox"/>	<input type="checkbox"/> <input type="checkbox"/>	<input type="checkbox"/> <input type="checkbox"/>	<input type="checkbox"/> <input type="checkbox"/>	<input type="checkbox"/> <input type="checkbox"/>	<input type="checkbox"/> <input type="checkbox"/>	55.00#	1852	240
	Left and Right Facing Chair Connector	SPMCLCRC/FC	<input type="checkbox"/> <input type="checkbox"/> <input type="checkbox"/> <input type="checkbox"/>	<input type="checkbox"/> <input type="checkbox"/> <input type="checkbox"/> <input type="checkbox"/>	<input type="checkbox"/> <input type="checkbox"/>	<input type="checkbox"/> <input type="checkbox"/>	<input type="checkbox"/> <input type="checkbox"/>	<input type="checkbox"/> <input type="checkbox"/>	<input type="checkbox"/> <input type="checkbox"/>	55.00#	1852	240
			<b>A</b>	<b>B</b>	<b>C</b>	<b>D</b>	<b>E</b>	<b>F</b>	<b>G</b>	<b>H</b>		

**HOW TO ORDER**

- Indicate the following information on order form:
- Quantity of each item.
  - Model number, including options. See "How To Build a Model Number".
  - Any special service required.

Note: • The  indicates that a choice is required.  
 • The absence of the  indicates that no choice is required.  
 • Alpha-numeric characters in place of  indicate that no other alternatives are available.

**HOW TO BUILD A MODEL NUMBER**

- A** Select basic model.
- B** Select non-contrast or fabric contrast 1. Refer to [ki.com/fabrics](http://ki.com/fabrics).  
 • For yardage pricing, see Fabric Yardage Pricing page
- C** Select fabric contrast 2. Refer to [ki.com/fabrics](http://ki.com/fabrics).  
 • For yardage pricing, see Fabric Yardage Pricing page
- D** Select base finish color. Refer to the **Product Color Options** page in this price list.
- E** Select armcaps.  
**PACBL** - Black poly armcap; add \$94  
**PACSA** - Sand poly; add \$94  
**PACWG** - Warm Grey poly; add \$94  
**WAC** - Wood armcaps (pair)  
**SAC** - Solid surface armcaps; add \$706 Upcharge for two armcaps.

Solid surface armcap color is always Corian™ white.

- F** Select wood finish color. Refer to the **Product Color Options** page in this price list. Wood finish selection is for wood armcaps. For Kensington Maple add upcharge.
- G** Select nylon glide color.  
**NGFN** - Flannel (Dark Grey)  
**NGNT** - Natural (Cream)
- H** Select moisture barrier.  
**MB** - Moisture barrier  
**NMB** - No moisture barrier  
 See pricing column for moisture barrier upcharge.

**KENSINGTON MAPLE UPCHARGE**

Kensington Maple requires extended leadtimes.  
 Model  
 All variations of One Seat Models:  
 SOMC \$63  
 SPMC \$63  
  
 All variations of Two Seat Models:  
 SOMCC \$94  
 SPMCC \$94  
  
 All variations of Three Seat Models:  
 SOMCCC \$125  
 SPMCCC \$125

**SPECIAL SERVICES**

**Special Carton Marking**  
 With specially marked information N/C  
  
**Shipping**  
 Ships **assembled, FOB High Point, NC 27263, freight prepaid.** Freight class 175  
  
 Specifications and prices are subject to change without prior notice.

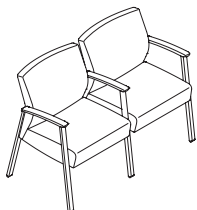
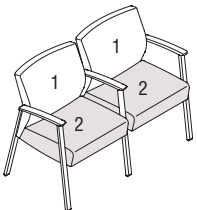

Features	MODEL NUMBER								Approx. Packaged Weight	Delivered Pricing	Moisture Barrier add to list price	
	Basic Model	Non-Contrast or Fabric Contrast 1	Fabric Contrast 2	Base Finish	Arm Cap	Wood Finish	Glide Color	Moist. Barrier				
 SMMC <b>Two Seat Unit (Open Arm) Non-Contrast</b> • Non-contrast C.O.M = 3 yd	No Connector	SOMCC/NC	<input type="checkbox"/> <input type="checkbox"/> <input type="checkbox"/> <input type="checkbox"/>		<input type="checkbox"/> <input type="checkbox"/>	<input type="checkbox"/> <input type="checkbox"/>	<input type="checkbox"/> <input type="checkbox"/>	<input type="checkbox"/> <input type="checkbox"/>		95.00#	\$ 2602	\$ 254
	Left Facing Chair Connector	SOMCCLC/NC	<input type="checkbox"/> <input type="checkbox"/> <input type="checkbox"/> <input type="checkbox"/>		<input type="checkbox"/> <input type="checkbox"/>	<input type="checkbox"/> <input type="checkbox"/>	<input type="checkbox"/> <input type="checkbox"/>	<input type="checkbox"/> <input type="checkbox"/>		95.00#	2602	254
	Right Facing Chair Connector	SOMCCRC/NC	<input type="checkbox"/> <input type="checkbox"/> <input type="checkbox"/> <input type="checkbox"/>		<input type="checkbox"/> <input type="checkbox"/>	<input type="checkbox"/> <input type="checkbox"/>	<input type="checkbox"/> <input type="checkbox"/>	<input type="checkbox"/> <input type="checkbox"/>		95.00#	2602	254
	Left and Right Facing Chair Connector	SOMCCLCRC/NC	<input type="checkbox"/> <input type="checkbox"/> <input type="checkbox"/> <input type="checkbox"/>		<input type="checkbox"/> <input type="checkbox"/>	<input type="checkbox"/> <input type="checkbox"/>	<input type="checkbox"/> <input type="checkbox"/>	<input type="checkbox"/> <input type="checkbox"/>		95.00#	2602	254
 SMMC <b>Two Seat Unit (Open Arm) Contrast</b> • 1 = Back (Fabric Contrast 1) C.O.M. = 2 yd • 2 = Seat (Fabric Contrast 2) C.O.M. = 2 yd	No Connector	SOMCC/FC	<input type="checkbox"/> <input type="checkbox"/> <input type="checkbox"/> <input type="checkbox"/>	<input type="checkbox"/> <input type="checkbox"/> <input type="checkbox"/> <input type="checkbox"/>	<input type="checkbox"/> <input type="checkbox"/>	<input type="checkbox"/> <input type="checkbox"/>	<input type="checkbox"/> <input type="checkbox"/>	<input type="checkbox"/> <input type="checkbox"/>		95.00#	\$ 2712	\$ 254
	Left Facing Chair Connector	SOMCCLC/FC	<input type="checkbox"/> <input type="checkbox"/> <input type="checkbox"/> <input type="checkbox"/>	<input type="checkbox"/> <input type="checkbox"/> <input type="checkbox"/> <input type="checkbox"/>	<input type="checkbox"/> <input type="checkbox"/>	<input type="checkbox"/> <input type="checkbox"/>	<input type="checkbox"/> <input type="checkbox"/>	<input type="checkbox"/> <input type="checkbox"/>		95.00#	2712	254
	Right Facing Chair Connector	SOMCCRC/FC	<input type="checkbox"/> <input type="checkbox"/> <input type="checkbox"/> <input type="checkbox"/>	<input type="checkbox"/> <input type="checkbox"/> <input type="checkbox"/> <input type="checkbox"/>	<input type="checkbox"/> <input type="checkbox"/>	<input type="checkbox"/> <input type="checkbox"/>	<input type="checkbox"/> <input type="checkbox"/>	<input type="checkbox"/> <input type="checkbox"/>		95.00#	2712	254
	Left and Right Facing Chair Connector	SOMCCLCRC/FC	<input type="checkbox"/> <input type="checkbox"/> <input type="checkbox"/> <input type="checkbox"/>	<input type="checkbox"/> <input type="checkbox"/> <input type="checkbox"/> <input type="checkbox"/>	<input type="checkbox"/> <input type="checkbox"/>	<input type="checkbox"/> <input type="checkbox"/>	<input type="checkbox"/> <input type="checkbox"/>	<input type="checkbox"/> <input type="checkbox"/>		95.00#	2712	254
			<b>A</b>	<b>B</b>	<b>C</b>	<b>D</b>	<b>E</b>	<b>F</b>	<b>G</b>	<b>H</b>		

**HOW TO ORDER**

- Indicate the following information on order form:
- Quantity of each item.
  - Model number, including options. See "How To Build a Model Number".
  - Any special service required.

Note: • The  indicates that a choice is required.  
 • The absence of the  indicates that no choice is required.  
 • Alpha-numeric characters in place of  indicate that no other alternatives are available.

**HOW TO BUILD A MODEL NUMBER**

- A** Select basic model.
- B** Select non-contrast or fabric contrast 1. Refer to [ki.com/fabrics](http://ki.com/fabrics).  
 • For yardage pricing, see Fabric Yardage Pricing page
- C** Select fabric contrast 2. Refer to [ki.com/fabrics](http://ki.com/fabrics).  
 • For yardage pricing, see Fabric Yardage Pricing page
- D** Select base finish color. Refer to the **Product Color Options** page in this price list.
- E** Select armcaps.  
 PACBL - Black poly armcap; add \$94  
 PACSA - Sand poly; add \$94  
 PACWG - Warm Grey poly; add \$94  
 WAC - Wood armcaps (pair)  
 SAC - Solid surface armcaps; add \$706 Upcharge for two armcaps.

Solid surface armcap color is always Corian™ white.

- F** Select wood finish color. Refer to the **Product Color Options** page in this price list. Wood finish selection is for wood armcaps. For Kensington Maple add upcharge.
- G** Select nylon glide color.  
 NGFN - Flannel (Dark Grey)  
 NGNT - Natural (Cream)
- H** Select moisture barrier.  
 MB - Moisture barrier  
 NMB - No moisture barrier  
 See pricing column for moisture barrier upcharge.

**KENSINGTON MAPLE UPCHARGE**

Kensington Maple requires extended leadtimes.  
 Model  
 All variations of One Seat Models:  
 SOMC \$63  
 SPMC \$63  
  
 All variations of Two Seat Models:  
 SOMCC \$94  
 SPMCC \$94  
  
 All variations of Three Seat Models:  
 SOMCCC \$125  
 SPMCCC \$125

**SPECIAL SERVICES**

**Special Carton Marking**  
 With specially marked information N/C  
  
**Shipping**  
 Ships assembled, FOB High Point, NC 27263, freight prepaid. Freight class 175  
  
 Specifications and prices are subject to change without prior notice.

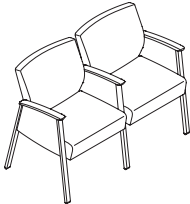
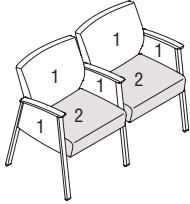

Features	MODEL NUMBER								Approx. Packaged Weight	Delivered Pricing	Moisture Barrier add to list price	
	Basic Model	Non-Contrast or Fabric Contrast 1	Fabric Contrast 2	Base Finish	Arm Cap	Wood Finish	Glide Color	Moist. Barrier				
	No Connector	SPMCC/NC	<input type="checkbox"/> <input type="checkbox"/> <input type="checkbox"/> <input type="checkbox"/>		<input type="checkbox"/> <input type="checkbox"/>	<input type="checkbox"/> <input type="checkbox"/>	<input type="checkbox"/> <input type="checkbox"/>	<input type="checkbox"/> <input type="checkbox"/>		105.00#	\$ 2902	\$ 272
	Left Facing Chair Connector	SPMCCLC/NC	<input type="checkbox"/> <input type="checkbox"/> <input type="checkbox"/> <input type="checkbox"/>		<input type="checkbox"/> <input type="checkbox"/>	<input type="checkbox"/> <input type="checkbox"/>	<input type="checkbox"/> <input type="checkbox"/>	<input type="checkbox"/> <input type="checkbox"/>		105.00#	2902	272
	Right Facing Chair Connector	SPMCCRC/NC	<input type="checkbox"/> <input type="checkbox"/> <input type="checkbox"/> <input type="checkbox"/>		<input type="checkbox"/> <input type="checkbox"/>	<input type="checkbox"/> <input type="checkbox"/>	<input type="checkbox"/> <input type="checkbox"/>	<input type="checkbox"/> <input type="checkbox"/>		105.00#	2902	272
	Left and Right Facing Chair Connector	SPMCCLCRC/NC	<input type="checkbox"/> <input type="checkbox"/> <input type="checkbox"/> <input type="checkbox"/>		<input type="checkbox"/> <input type="checkbox"/>	<input type="checkbox"/> <input type="checkbox"/>	<input type="checkbox"/> <input type="checkbox"/>	<input type="checkbox"/> <input type="checkbox"/>		105.00#	2902	272
<p>SMMC</p> <p><b>Two Seat Unit (Closed Arm) Non-Contrast</b></p> <ul style="list-style-type: none"> <li>• Non-contrast C.O.M = 4.25 yd</li> </ul>												
	No Connector	SPMCC/FC	<input type="checkbox"/> <input type="checkbox"/> <input type="checkbox"/> <input type="checkbox"/>	<input type="checkbox"/> <input type="checkbox"/> <input type="checkbox"/> <input type="checkbox"/>	<input type="checkbox"/> <input type="checkbox"/>	<input type="checkbox"/> <input type="checkbox"/>	<input type="checkbox"/> <input type="checkbox"/>	<input type="checkbox"/> <input type="checkbox"/>		105.00#	\$ 3011	\$ 272
	Left Facing Chair Connector	SPMCCLC/FC	<input type="checkbox"/> <input type="checkbox"/> <input type="checkbox"/> <input type="checkbox"/>	<input type="checkbox"/> <input type="checkbox"/> <input type="checkbox"/> <input type="checkbox"/>	<input type="checkbox"/> <input type="checkbox"/>	<input type="checkbox"/> <input type="checkbox"/>	<input type="checkbox"/> <input type="checkbox"/>	<input type="checkbox"/> <input type="checkbox"/>		105.00#	3011	272
	Right Facing Chair Connector	SPMCCRC/FC	<input type="checkbox"/> <input type="checkbox"/> <input type="checkbox"/> <input type="checkbox"/>	<input type="checkbox"/> <input type="checkbox"/> <input type="checkbox"/> <input type="checkbox"/>	<input type="checkbox"/> <input type="checkbox"/>	<input type="checkbox"/> <input type="checkbox"/>	<input type="checkbox"/> <input type="checkbox"/>	<input type="checkbox"/> <input type="checkbox"/>		105.00#	3011	272
	Left and Right Facing Chair Connector	SPMCCLCRC/FC	<input type="checkbox"/> <input type="checkbox"/> <input type="checkbox"/> <input type="checkbox"/>	<input type="checkbox"/> <input type="checkbox"/> <input type="checkbox"/> <input type="checkbox"/>	<input type="checkbox"/> <input type="checkbox"/>	<input type="checkbox"/> <input type="checkbox"/>	<input type="checkbox"/> <input type="checkbox"/>	<input type="checkbox"/> <input type="checkbox"/>		105.00#	3011	272
<p>SMMC</p> <p><b>Two Seat Unit (Closed Arm) Contrast</b></p> <ul style="list-style-type: none"> <li>• 1 = Back and arms (Fabric Contrast 1) C.O.M. = 3.25 yd</li> <li>• 2 = Seat (Fabric Contrast 2) C.O.M. = 1.5 yd</li> </ul>												
<p><b>A B C D E F G H</b></p>												

**HOW TO ORDER**

- Indicate the following information on order form:
1. Quantity of each item.
  2. Model number, including options. See "How To Build a Model Number".
  3. Any special service required.

Note:

- The  indicates that a choice is required.
- The absence of the  indicates that no choice is required.
- Alpha-numeric characters in place of  indicate that no other alternatives are available.

**HOW TO BUILD A MODEL NUMBER**

- A** Select basic model.
  - B** Select non-contrast or fabric contrast 1. Refer to [ki.com/fabrics](http://ki.com/fabrics).
    - For yardage pricing, see Fabric Yardage Pricing page
  - C** Select fabric contrast 2. Refer to [ki.com/fabrics](http://ki.com/fabrics).
    - For yardage pricing, see Fabric Yardage Pricing page
  - D** Select base finish color. Refer to the **Product Color Options** page in this price list.
  - E** Select armcaps.
    - PACBL** - Black poly armcap; add \$141
    - PACSA** - Sand poly; add \$141
    - PACWG** - Warm Grey poly; add \$141
    - WAC** - Wood armcaps (pair)
    - SAC** - Solid surface armcaps; add \$1017 Upcharge for three armcaps.
  - F** Select wood finish color. Refer to the **Product Color Options** page in this price list. Wood finish selection is for wood armcaps. For Kensington Maple add upcharge.
  - G** Select nylon glide color.
    - NGFN** - Flannel (Dark Grey)
    - NGNT** - Natural (Cream)
  - H** Select moisture barrier.
    - MB** - Moisture barrier
    - NMB** - No moisture barrier
 See pricing column for moisture barrier upcharge.
- Solid surface armcap color is always Corian™ white.

**KENSINGTON MAPLE UPCHARGE**

- Kensington Maple requires extended leadtimes.
- Model
- All variations of One Seat Models:
- SOMC \$63
  - SPMC \$63
- All variations of Two Seat Models:
- SOMCC \$94
  - SPMCC \$94
- All variations of Three Seat Models:
- SOMCCC \$125
  - SPMCCC \$125

**SPECIAL SERVICES**

- Special Carton Marking**
- With specially marked information N/C
- Shipping**
- Ships **assembled, FOB High Point, NC 27263, freight prepaid.** Freight class 175
- Specifications and prices are subject to change without prior notice.

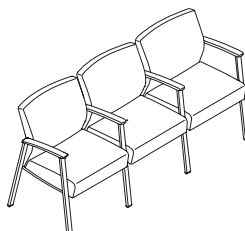
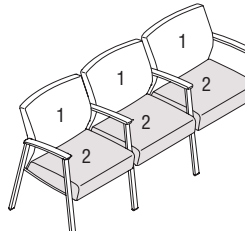

Features	MODEL NUMBER								Approx. Packaged Weight	Delivered Pricing	Moisture Barrier add to list price
	Basic Model	Non-Contrast or Fabric Contrast 1	Fabric Contrast 2	Base Finish	Arm Cap	Wood Finish	Glide Color	Moist. Barrier			
 <p>SMMC <b>Three Seat Unit (Open Arm) Non-Contrast</b> • Non-contrast C.O.M = 4.5 yd</p>	No Connector	SOMCCC/NC	<input type="checkbox"/> <input type="checkbox"/> <input type="checkbox"/> <input type="checkbox"/>		<input type="checkbox"/> <input type="checkbox"/>	<input type="checkbox"/> <input type="checkbox"/>	<input type="checkbox"/> <input type="checkbox"/>	<input type="checkbox"/> <input type="checkbox"/>	125.00#	\$ 3695	\$ 280
	Left Facing Chair Connector	SOMCCCLC/NC	<input type="checkbox"/> <input type="checkbox"/> <input type="checkbox"/> <input type="checkbox"/>		<input type="checkbox"/> <input type="checkbox"/>	<input type="checkbox"/> <input type="checkbox"/>	<input type="checkbox"/> <input type="checkbox"/>	<input type="checkbox"/> <input type="checkbox"/>	125.00#	3695	280
	Right Facing Chair Connector	SOMCCRC/NC	<input type="checkbox"/> <input type="checkbox"/> <input type="checkbox"/> <input type="checkbox"/>		<input type="checkbox"/> <input type="checkbox"/>	<input type="checkbox"/> <input type="checkbox"/>	<input type="checkbox"/> <input type="checkbox"/>	<input type="checkbox"/> <input type="checkbox"/>	125.00#	3695	280
	Left and Right Facing Chair Connector	SOMCCCLCRC/NC	<input type="checkbox"/> <input type="checkbox"/> <input type="checkbox"/> <input type="checkbox"/>		<input type="checkbox"/> <input type="checkbox"/>	<input type="checkbox"/> <input type="checkbox"/>	<input type="checkbox"/> <input type="checkbox"/>	<input type="checkbox"/> <input type="checkbox"/>	125.00#	3695	280
 <p>SMMC <b>Three Seat Unit (Open Arm) Contrast</b> • 1 = Back (Fabric Contrast 1) C.O.M. = 3 yd • 2 = Seat (Fabric Contrast 2) C.O.M. = 2.25 yd</p>	No Connector	SOMCCC/FC	<input type="checkbox"/> <input type="checkbox"/> <input type="checkbox"/> <input type="checkbox"/>	<input type="checkbox"/> <input type="checkbox"/> <input type="checkbox"/> <input type="checkbox"/>	<input type="checkbox"/> <input type="checkbox"/>	<input type="checkbox"/> <input type="checkbox"/>	<input type="checkbox"/> <input type="checkbox"/>	<input type="checkbox"/> <input type="checkbox"/>	125.00#	\$ 3852	\$ 280
	Left Facing Chair Connector	SOMCCCLC/FC	<input type="checkbox"/> <input type="checkbox"/> <input type="checkbox"/> <input type="checkbox"/>	<input type="checkbox"/> <input type="checkbox"/> <input type="checkbox"/> <input type="checkbox"/>	<input type="checkbox"/> <input type="checkbox"/>	<input type="checkbox"/> <input type="checkbox"/>	<input type="checkbox"/> <input type="checkbox"/>	<input type="checkbox"/> <input type="checkbox"/>	125.00#	3852	280
	Right Facing Chair Connector	SOMCCRC/FC	<input type="checkbox"/> <input type="checkbox"/> <input type="checkbox"/> <input type="checkbox"/>	<input type="checkbox"/> <input type="checkbox"/> <input type="checkbox"/> <input type="checkbox"/>	<input type="checkbox"/> <input type="checkbox"/>	<input type="checkbox"/> <input type="checkbox"/>	<input type="checkbox"/> <input type="checkbox"/>	<input type="checkbox"/> <input type="checkbox"/>	125.00#	3852	280
	Left and Right Facing Chair Connector	SOMCCCLCRC/FC	<input type="checkbox"/> <input type="checkbox"/> <input type="checkbox"/> <input type="checkbox"/>	<input type="checkbox"/> <input type="checkbox"/> <input type="checkbox"/> <input type="checkbox"/>	<input type="checkbox"/> <input type="checkbox"/>	<input type="checkbox"/> <input type="checkbox"/>	<input type="checkbox"/> <input type="checkbox"/>	<input type="checkbox"/> <input type="checkbox"/>	125.00#	3852	280
			<b>A</b>	<b>B</b>	<b>C</b>	<b>D</b>	<b>E</b>	<b>F</b>	<b>G</b>	<b>H</b>	

**HOW TO ORDER**

Indicate the following information on order form:  
 1. Quantity of each item.  
 2. Model number, including options. See "How To Build a Model Number".  
 3. Any special service required.

Note: • The  indicates that a choice is required.  
 • The absence of the  indicates that no choice is required.  
 • Alpha-numeric characters in place of  indicate that no other alternatives are available.

**HOW TO BUILD A MODEL NUMBER**

- A** Select basic model.
- B** Select non-contrast or fabric contrast 1. Refer to [ki.com/fabrics](http://ki.com/fabrics).  
 • For yardage pricing, see Fabric Yardage Pricing page
- C** Select fabric contrast 2. Refer to [ki.com/fabrics](http://ki.com/fabrics).  
 • For yardage pricing, see Fabric Yardage Pricing page
- D** Select base finish color. Refer to the **Product Color Options** page in this price list.
- E** Select armcaps.  
 PACBL - Black poly armcap; add \$189  
 PACSA - Sand poly; add \$189  
 PACWG - Warm Grey poly; add \$189  
 WAC - Wood armcaps (pair)  
 SAC - Solid surface armcaps; add \$1328  
 Upcharge for four armcaps.

Solid surface armcap color is always Corian™ white.

**F** Select wood finish color. Refer to the **Product Color Options** page in this price list. Wood finish selection is for wood armcaps. For Kensington Maple add upcharge.

**G** Select nylon glide color.  
 NGFN - Flannel (Dark Grey)  
 NGNT - Natural (Cream)

**H** Select moisture barrier.  
 MB - Moisture barrier  
 NMB - No moisture barrier  
 See pricing column for moisture barrier upcharge.

**KENSINGTON MAPLE UPCHARGE**

Kensington Maple requires extended leadtimes.  
 Model  
 All variations of One Seat Models:  
 SOMC \$63  
 SPMC \$63  
  
 All variations of Two Seat Models:  
 SOMCC \$94  
 SPMCC \$94  
  
 All variations of Three Seat Models:  
 SOMCCC \$125  
 SPMCCC \$125

**SPECIAL SERVICES**

**Special Carton Marking**  
 With specially marked information N/C  
  
**Shipping**  
 Ships assembled, FOB High Point, NC 27263, freight prepaid. Freight class 175  
  
 Specifications and prices are subject to change without prior notice.

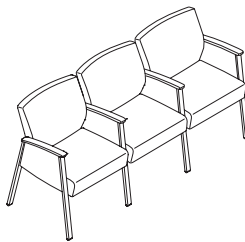
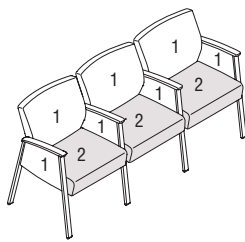

Features	MODEL NUMBER								Approx. Packaged Weight	Delivered Pricing	Moisture Barrier add to list price
	Basic Model	Non-Contrast or Fabric Contrast 1	Fabric Contrast 2	Base Finish	Arm Cap	Wood Finish	Glide Color	Moist. Barrier			
 <p>SMMC <b>Three Seat Unit (Closed Arm) Non-Contrast</b></p> <ul style="list-style-type: none"> <li>• Non-contrast C.O.M = 6.25 yd</li> </ul>	No Connector	SPMCCC/NC	<input type="checkbox"/> <input type="checkbox"/> <input type="checkbox"/> <input type="checkbox"/>	<input type="checkbox"/>	<input type="checkbox"/>	<input type="checkbox"/>	<input type="checkbox"/>	<input type="checkbox"/>	135.00#	\$ 4120	\$ 300
	Left Facing Chair Connector	SPMCCCLC/NC	<input type="checkbox"/> <input type="checkbox"/> <input type="checkbox"/> <input type="checkbox"/>	<input type="checkbox"/>	<input type="checkbox"/>	<input type="checkbox"/>	<input type="checkbox"/>	<input type="checkbox"/>	135.00#	4120	300
	Right Facing Chair Connector	SPMCCRC/NC	<input type="checkbox"/> <input type="checkbox"/> <input type="checkbox"/> <input type="checkbox"/>	<input type="checkbox"/>	<input type="checkbox"/>	<input type="checkbox"/>	<input type="checkbox"/>	<input type="checkbox"/>	135.00#	4120	300
	Left and Right Facing Chair Connector	SPMCCCLCRC/NC	<input type="checkbox"/> <input type="checkbox"/> <input type="checkbox"/> <input type="checkbox"/>	<input type="checkbox"/>	<input type="checkbox"/>	<input type="checkbox"/>	<input type="checkbox"/>	<input type="checkbox"/>	135.00#	4120	300
 <p>SMMC <b>Three Seat Unit (Closed Arm) Contrast</b></p> <ul style="list-style-type: none"> <li>• 1 = Back and arms (Fabric Contrast 1) C.O.M. = 4.75 yd</li> <li>• 2 = Seat (Fabric Contrast 2) C.O.M. = 2.25 yd</li> </ul>	No Connector	SPMCCC/FC	<input type="checkbox"/> <input type="checkbox"/> <input type="checkbox"/> <input type="checkbox"/>	<input type="checkbox"/>	<input type="checkbox"/>	<input type="checkbox"/>	<input type="checkbox"/>	<input type="checkbox"/>	135.00#	\$ 4278	\$ 300
	Left Facing Chair Connector	SPMCCCLC/FC	<input type="checkbox"/> <input type="checkbox"/> <input type="checkbox"/> <input type="checkbox"/>	<input type="checkbox"/>	<input type="checkbox"/>	<input type="checkbox"/>	<input type="checkbox"/>	<input type="checkbox"/>	135.00#	4278	300
	Right Facing Chair Connector	SPMCCRC/FC	<input type="checkbox"/> <input type="checkbox"/> <input type="checkbox"/> <input type="checkbox"/>	<input type="checkbox"/>	<input type="checkbox"/>	<input type="checkbox"/>	<input type="checkbox"/>	<input type="checkbox"/>	135.00#	4278	300
	Left and Right Facing Chair Connector	SPMCCCLCRC/FC	<input type="checkbox"/> <input type="checkbox"/> <input type="checkbox"/> <input type="checkbox"/>	<input type="checkbox"/>	<input type="checkbox"/>	<input type="checkbox"/>	<input type="checkbox"/>	<input type="checkbox"/>	135.00#	4278	300

**A B C D E F G H**

**HOW TO ORDER**

- Indicate the following information on order form:
- Quantity of each item.
  - Model number, including options. See "How To Build a Model Number".
  - Any special service required.

Note: • The  indicates that a choice is required.  
• The absence of the  indicates that no choice is required.  
• Alpha-numeric characters in place of  indicate that no other alternatives are available.

**HOW TO BUILD A MODEL NUMBER**

- A** Select basic model.
- B** Select non-contrast or fabric contrast 1. Refer to [ki.com/fabrics](http://ki.com/fabrics).  
• For yardage pricing, see Fabric Yardage Pricing page
- C** Select fabric contrast 2. Refer to [ki.com/fabrics](http://ki.com/fabrics).  
• For yardage pricing, see Fabric Yardage Pricing page
- D** Select base finish color. Refer to the **Product Color Options** page in this price list.
- E** Select armcaps.  

<b>PACBL</b>	- Black poly armcap; add \$189
<b>PACSA</b>	- Sand poly; add \$189
<b>PACWG</b>	- Warm Grey poly; add \$189
<b>WAC</b>	- Wood armcaps (pair)
<b>SAC</b>	- Solid surface armcaps; add \$1328

 Upcharge for four armcaps.

Solid surface armcap color is always Corian™ white.

- F** Select wood finish color. Refer to the **Product Color Options** page in this price list. Wood finish selection is for wood armcaps. For Kensington Maple add upcharge.
- G** Select nylon glide color.  

<b>NGFN</b>	- Flannel (Dark Grey)
<b>NGNT</b>	- Natural (Cream)
- H** Select moisture barrier.  

<b>MB</b>	- Moisture barrier
<b>NMB</b>	- No moisture barrier

 See pricing column for moisture barrier upcharge.

**KENSINGTON MAPLE UPCHARGE**

Kensington Maple requires extended leadtimes.

Model

All variations of One Seat Models:

SOMC	\$63
SPMC	\$63

All variations of Two Seat Models:

SOMCC	\$94
SPMCC	\$94

All variations of Three Seat Models:

SOMCCC	\$125
SPMCCC	\$125

**SPECIAL SERVICES**

**Special Carton Marking**

With specially marked information N/C

**Shipping**  
Ships assembled, FOB High Point, NC 27263, freight prepaid. Freight class 175

Specifications and prices are subject to change without prior notice.

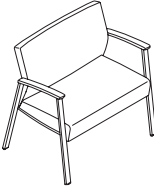
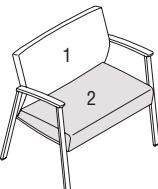

Features	MODEL NUMBER								Approx. Packaged Weight	Delivered Pricing	Moisture Barrier add to list price
	Basic Model	Non-Contrast or Fabric Contrast 1	Fabric Contrast 2	Base Finish	Arm Cap	Wood Finish	Glide Color	Moist. Barrier			
 <p>SMMB Bariatric Lounge (Open Arm) Non-Contrast</p> <ul style="list-style-type: none"> <li>• Non-contrast C.O.M = 2.5 yd</li> </ul>	No Connector	SOMB/NC	<input type="checkbox"/> <input type="checkbox"/> <input type="checkbox"/> <input type="checkbox"/>		<input type="checkbox"/> <input type="checkbox"/>	<input type="checkbox"/> <input type="checkbox"/>	<input type="checkbox"/> <input type="checkbox"/>	<input type="checkbox"/> <input type="checkbox"/>	70.00#	\$ 2392	\$ 240
	Left Facing Chair Connector	SOMBLC/NC	<input type="checkbox"/> <input type="checkbox"/> <input type="checkbox"/> <input type="checkbox"/>		<input type="checkbox"/> <input type="checkbox"/>	<input type="checkbox"/> <input type="checkbox"/>	<input type="checkbox"/> <input type="checkbox"/>	<input type="checkbox"/> <input type="checkbox"/>	70.00#	2392	240
	Right Facing Chair Connector	SOMBRC/NC	<input type="checkbox"/> <input type="checkbox"/> <input type="checkbox"/> <input type="checkbox"/>		<input type="checkbox"/> <input type="checkbox"/>	<input type="checkbox"/> <input type="checkbox"/>	<input type="checkbox"/> <input type="checkbox"/>	<input type="checkbox"/> <input type="checkbox"/>	70.00#	2392	240
	Left and Right Facing Chair Connector	SOMBLCRC/NC	<input type="checkbox"/> <input type="checkbox"/> <input type="checkbox"/> <input type="checkbox"/>		<input type="checkbox"/> <input type="checkbox"/>	<input type="checkbox"/> <input type="checkbox"/>	<input type="checkbox"/> <input type="checkbox"/>	<input type="checkbox"/> <input type="checkbox"/>	70.00#	2392	240
 <p>SMMB Bariatric Lounge (Open Arm) Contrast</p> <ul style="list-style-type: none"> <li>• 1 = Back (Fabric Contrast 1) C.O.M. = 1.5 yd</li> <li>• 2 = Seat (Fabric Contrast 2) C.O.M. = 1.25 yd</li> </ul>	No Connector	SOMB/FC	<input type="checkbox"/> <input type="checkbox"/> <input type="checkbox"/> <input type="checkbox"/>	<input type="checkbox"/> <input type="checkbox"/> <input type="checkbox"/> <input type="checkbox"/>	<input type="checkbox"/> <input type="checkbox"/>	<input type="checkbox"/> <input type="checkbox"/>	<input type="checkbox"/> <input type="checkbox"/>	<input type="checkbox"/> <input type="checkbox"/>	70.00#	\$ 2471	\$ 240
	Left Facing Chair Connector	SOMBLC/FC	<input type="checkbox"/> <input type="checkbox"/> <input type="checkbox"/> <input type="checkbox"/>	<input type="checkbox"/> <input type="checkbox"/> <input type="checkbox"/> <input type="checkbox"/>	<input type="checkbox"/> <input type="checkbox"/>	<input type="checkbox"/> <input type="checkbox"/>	<input type="checkbox"/> <input type="checkbox"/>	<input type="checkbox"/> <input type="checkbox"/>	70.00#	2471	240
	Right Facing Chair Connector	SOMBRC/FC	<input type="checkbox"/> <input type="checkbox"/> <input type="checkbox"/> <input type="checkbox"/>	<input type="checkbox"/> <input type="checkbox"/> <input type="checkbox"/> <input type="checkbox"/>	<input type="checkbox"/> <input type="checkbox"/>	<input type="checkbox"/> <input type="checkbox"/>	<input type="checkbox"/> <input type="checkbox"/>	<input type="checkbox"/> <input type="checkbox"/>	70.00#	2471	240
	Left and Right Facing Chair Connector	SOMBLCRC/FC	<input type="checkbox"/> <input type="checkbox"/> <input type="checkbox"/> <input type="checkbox"/>	<input type="checkbox"/> <input type="checkbox"/> <input type="checkbox"/> <input type="checkbox"/>	<input type="checkbox"/> <input type="checkbox"/>	<input type="checkbox"/> <input type="checkbox"/>	<input type="checkbox"/> <input type="checkbox"/>	<input type="checkbox"/> <input type="checkbox"/>	70.00#	2471	240
			<b>A</b>	<b>B</b>	<b>C</b>	<b>D</b>	<b>E</b>	<b>F</b>	<b>G</b>	<b>H</b>	

**HOW TO ORDER**

Indicate the following information on order form:

- Quantity of each item.
- Model number, including options. See "How To Build a Model Number".
- Any special service required.

Note:

- The  indicates that a choice is required.
- The absence of the  indicates that no choice is required.
- Alpha-numeric characters in place of  indicate that no other alternatives are available.

**HOW TO BUILD A MODEL NUMBER**

**A** Select basic model.

**B** Select non-contrast or fabric contrast 1. Refer to [ki.com/fabrics](http://ki.com/fabrics).

- For yardage pricing, see Fabric Yardage Pricing page

**C** Select fabric contrast 2. Refer to [ki.com/fabrics](http://ki.com/fabrics).

- For yardage pricing, see Fabric Yardage Pricing page

**D** Select base finish color. Refer to the **Product Color Options** page in this price list.

**E** Select armcaps.

- PACBL** - Black poly armcap; add \$94
- PACSA** - Sand poly; add \$94
- PACWG** - Warm Grey poly; add \$94
- WAC** - Wood armcaps (pair)
- SAC** - Solid surface armcaps; add \$706 Upcharge for four armcaps.

Solid surface armcap color is always Corian™ white.

**F** Select wood finish color. Refer to the **Product Color Options** page in this price list. Wood finish selection is for wood armcaps. For Kensington Maple add upcharge.

**G** Select nylon glide color.

- NGFN** - Flannel (Dark Grey)
- NGNT** - Natural (Cream)

**H** Select moisture barrier.

- MB** - Moisture barrier
- NMB** - No moisture barrier

See pricing column for moisture barrier upcharge.

**KENSINGTON MAPLE UPCHARGE**

Kensington Maple requires extended leadtimes.

Model

All variations of Bariatric Models:

- SOMB \$63
- SPMB \$63

All variations of Loveseat Models:

- SOM33 \$63
- SPM33 \$63

All variations of Spanner Models:

- SOM3S \$125
- SPM3S \$125

**SPECIAL SERVICES**

**Special Carton Marking**

With specially marked information N/C

**Shipping**

Ships **assembled, FOB High Point, NC 27263, freight prepaid.** Freight class 175

Specifications and prices are subject to change without prior notice.

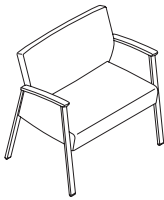
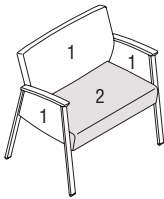

Features	MODEL NUMBER								Approx. Packaged Weight	Delivered Pricing	Moisture Barrier add to list price
	Basic Model	Non-Contrast or Fabric Contrast 1	Fabric Contrast 2	Base Finish	Arm Cap	Wood Finish	Glide Color	Moist. Barrier			
 <p>SMMB <b>Bariatric Lounge (Closed Arm) Non-Contrast</b> • Non-contrast C.O.M = 3 yd</p>	No Connector	SPMB/NC	<input type="checkbox"/> <input type="checkbox"/> <input type="checkbox"/> <input type="checkbox"/>	<input type="checkbox"/> <input type="checkbox"/>	<input type="checkbox"/> <input type="checkbox"/>	<input type="checkbox"/> <input type="checkbox"/>	<input type="checkbox"/> <input type="checkbox"/>	<input type="checkbox"/> <input type="checkbox"/>	80.00#	\$ 2746	\$ 263
	Left Facing Chair Connector	SPMBLC/NC	<input type="checkbox"/> <input type="checkbox"/> <input type="checkbox"/> <input type="checkbox"/>	<input type="checkbox"/> <input type="checkbox"/>	<input type="checkbox"/> <input type="checkbox"/>	<input type="checkbox"/> <input type="checkbox"/>	<input type="checkbox"/> <input type="checkbox"/>	<input type="checkbox"/> <input type="checkbox"/>	80.00#	2746	263
	Right Facing Chair Connector	SPMBRC/NC	<input type="checkbox"/> <input type="checkbox"/> <input type="checkbox"/> <input type="checkbox"/>	<input type="checkbox"/> <input type="checkbox"/>	<input type="checkbox"/> <input type="checkbox"/>	<input type="checkbox"/> <input type="checkbox"/>	<input type="checkbox"/> <input type="checkbox"/>	<input type="checkbox"/> <input type="checkbox"/>	80.00#	2746	263
	Left and Right Facing Chair Connector	SPMBLCRC/NC	<input type="checkbox"/> <input type="checkbox"/> <input type="checkbox"/> <input type="checkbox"/>	<input type="checkbox"/> <input type="checkbox"/>	<input type="checkbox"/> <input type="checkbox"/>	<input type="checkbox"/> <input type="checkbox"/>	<input type="checkbox"/> <input type="checkbox"/>	<input type="checkbox"/> <input type="checkbox"/>	80.00#	2746	263
 <p>SMMB <b>Bariatric Lounge (Closed Arm) Contrast</b> • 1 = Back and arms (Fabric Contrast 1) C.O.M. = 2.5 yd • 2 = Seat (Fabric Contrast 2) C.O.M. = 1.25 yd</p>	No Connector	SPMB/FC	<input type="checkbox"/> <input type="checkbox"/> <input type="checkbox"/> <input type="checkbox"/>	<input type="checkbox"/> <input type="checkbox"/>	<input type="checkbox"/> <input type="checkbox"/>	<input type="checkbox"/> <input type="checkbox"/>	<input type="checkbox"/> <input type="checkbox"/>	<input type="checkbox"/> <input type="checkbox"/>	80.00#	\$ 2824	\$ 263
	Left Facing Chair Connector	SPMBLC/FC	<input type="checkbox"/> <input type="checkbox"/> <input type="checkbox"/> <input type="checkbox"/>	<input type="checkbox"/> <input type="checkbox"/>	<input type="checkbox"/> <input type="checkbox"/>	<input type="checkbox"/> <input type="checkbox"/>	<input type="checkbox"/> <input type="checkbox"/>	<input type="checkbox"/> <input type="checkbox"/>	80.00#	2824	263
	Right Facing Chair Connector	SPMBRC/FC	<input type="checkbox"/> <input type="checkbox"/> <input type="checkbox"/> <input type="checkbox"/>	<input type="checkbox"/> <input type="checkbox"/>	<input type="checkbox"/> <input type="checkbox"/>	<input type="checkbox"/> <input type="checkbox"/>	<input type="checkbox"/> <input type="checkbox"/>	<input type="checkbox"/> <input type="checkbox"/>	80.00#	2824	263
	Left and Right Facing Chair Connector	SPMBLCRC/FC	<input type="checkbox"/> <input type="checkbox"/> <input type="checkbox"/> <input type="checkbox"/>	<input type="checkbox"/> <input type="checkbox"/>	<input type="checkbox"/> <input type="checkbox"/>	<input type="checkbox"/> <input type="checkbox"/>	<input type="checkbox"/> <input type="checkbox"/>	<input type="checkbox"/> <input type="checkbox"/>	80.00#	2824	263
	<b>A</b>	<b>B</b>	<b>C</b>	<b>D</b>	<b>E</b>	<b>F</b>	<b>G</b>	<b>H</b>			

**HOW TO ORDER**

- Indicate the following information on order form:
- Quantity of each item.
  - Model number, including options. See "How To Build a Model Number".
  - Any special service required.

Note: • The  indicates that a choice is required.  
• The absence of the  indicates that no choice is required.  
• Alpha-numeric characters in place of  indicate that no other alternatives are available.

**HOW TO BUILD A MODEL NUMBER**

- A** Select basic model.
- B** Select non-contrast or fabric contrast 1. Refer to [ki.com/fabrics](http://ki.com/fabrics).  
• For yardage pricing, see Fabric Yardage Pricing page
- C** Select fabric contrast 2. Refer to [ki.com/fabrics](http://ki.com/fabrics).  
• For yardage pricing, see Fabric Yardage Pricing page
- D** Select base finish color. Refer to the **Product Color Options** page in this price list.
- E** Select armcaps.  
**PACBL** - Black poly armcap; add \$94  
**PACSA** - Sand poly; add \$94  
**PACWG** - Warm Grey poly; add \$94  
**WAC** - Wood armcaps (pair)  
**SAC** - Solid surface armcaps; add \$706 Upcharge for four armcaps.

Solid surface armcap color is always Corian™ white.

- F** Select wood finish color. Refer to the **Product Color Options** page in this price list. Wood finish selection is for wood armcaps. For Kensington Maple add upcharge.
- G** Select nylon glide color.  
**NGFN** - Flannel (Dark Grey)  
**NGNT** - Natural (Cream)
- H** Select moisture barrier.  
**MB** - Moisture barrier  
**NMB** - No moisture barrier  
See pricing column for moisture barrier upcharge.

**California TB133 Fire Safety Code**  
For California Technical Bulletin 133 compliant models, a Product Modification Request is required. Contact Customer Service for details.

**KENSINGTON MAPLE UPCHARGE**

Kensington Maple requires extended leadtimes. Model  
All variations of Bariatric Models:  
SOMB \$63  
SPMB \$63  
  
All variations of Loveseat Models:  
SOM33 \$63  
SPM33 \$63  
  
All variations of Spanner Models:  
SOM3S \$125  
SPM3S \$125

**SPECIAL SERVICES**

**Special Carton Marking**  
With specially marked information N/C  
  
**Shipping**  
Ships assembled, FOB High Point, NC 27263, freight prepaid. Freight class 175  
  
Specifications and prices are subject to change without prior notice.

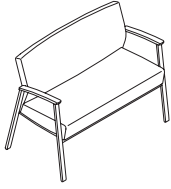
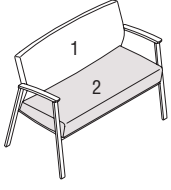
Features	MODEL NUMBER								Approx. Packaged Weight	Delivered Pricing	Moisture Barrier add to list price
	Basic Model	Non-Contrast or Fabric Contrast 1	Fabric Contrast 2	Base Finish	Arm Cap	Wood Finish	Glide Color	Moist. Barrier			
 SMML <b>Loveseat (Open Arm) Non-Contrast</b> • Non-contrast C.O.M = 2.5 yd	No Connector	SOM33/NC	<input type="checkbox"/> <input type="checkbox"/> <input type="checkbox"/> <input type="checkbox"/>		<input type="checkbox"/> <input type="checkbox"/>	<input type="checkbox"/> <input type="checkbox"/>	<input type="checkbox"/> <input type="checkbox"/>	<input type="checkbox"/> <input type="checkbox"/>	95.00#	\$ 2642	\$ 258
	Left Facing Chair Connector	SOM33LC/NC	<input type="checkbox"/> <input type="checkbox"/> <input type="checkbox"/> <input type="checkbox"/>		<input type="checkbox"/> <input type="checkbox"/>	<input type="checkbox"/> <input type="checkbox"/>	<input type="checkbox"/> <input type="checkbox"/>	<input type="checkbox"/> <input type="checkbox"/>	95.00#	2642	258
	Right Facing Chair Connector	SOM33RC/NC	<input type="checkbox"/> <input type="checkbox"/> <input type="checkbox"/> <input type="checkbox"/>		<input type="checkbox"/> <input type="checkbox"/>	<input type="checkbox"/> <input type="checkbox"/>	<input type="checkbox"/> <input type="checkbox"/>	<input type="checkbox"/> <input type="checkbox"/>	95.00#	2642	258
	Left and Right Facing Chair Connector	SOM33LCRC/NC	<input type="checkbox"/> <input type="checkbox"/> <input type="checkbox"/> <input type="checkbox"/>		<input type="checkbox"/> <input type="checkbox"/>	<input type="checkbox"/> <input type="checkbox"/>	<input type="checkbox"/> <input type="checkbox"/>	<input type="checkbox"/> <input type="checkbox"/>	95.00#	2642	258
 SMML <b>Loveseat (Open Arm) Contrast</b> • 1 = Back (Fabric Contrast 1) C.O.M. = 1.5 yd • 2 = Seat (Fabric Contrast 2) C.O.M. = 1.25 yd	No Connector	SOM33/FC	<input type="checkbox"/> <input type="checkbox"/> <input type="checkbox"/> <input type="checkbox"/>	<input type="checkbox"/> <input type="checkbox"/> <input type="checkbox"/> <input type="checkbox"/>	<input type="checkbox"/> <input type="checkbox"/>	<input type="checkbox"/> <input type="checkbox"/>	<input type="checkbox"/> <input type="checkbox"/>	<input type="checkbox"/> <input type="checkbox"/>	95.00#	\$ 2728	\$ 258
	Left Facing Chair Connector	SOM33LC/FC	<input type="checkbox"/> <input type="checkbox"/> <input type="checkbox"/> <input type="checkbox"/>	<input type="checkbox"/> <input type="checkbox"/> <input type="checkbox"/> <input type="checkbox"/>	<input type="checkbox"/> <input type="checkbox"/>	<input type="checkbox"/> <input type="checkbox"/>	<input type="checkbox"/> <input type="checkbox"/>	<input type="checkbox"/> <input type="checkbox"/>	95.00#	2728	258
	Right Facing Chair Connector	SOM33RC/FC	<input type="checkbox"/> <input type="checkbox"/> <input type="checkbox"/> <input type="checkbox"/>	<input type="checkbox"/> <input type="checkbox"/> <input type="checkbox"/> <input type="checkbox"/>	<input type="checkbox"/> <input type="checkbox"/>	<input type="checkbox"/> <input type="checkbox"/>	<input type="checkbox"/> <input type="checkbox"/>	<input type="checkbox"/> <input type="checkbox"/>	95.00#	2728	258
	Left and Right Facing Chair Connector	SOM33LCRC/FC	<input type="checkbox"/> <input type="checkbox"/> <input type="checkbox"/> <input type="checkbox"/>	<input type="checkbox"/> <input type="checkbox"/> <input type="checkbox"/> <input type="checkbox"/>	<input type="checkbox"/> <input type="checkbox"/>	<input type="checkbox"/> <input type="checkbox"/>	<input type="checkbox"/> <input type="checkbox"/>	<input type="checkbox"/> <input type="checkbox"/>	95.00#	2728	258
	<b>A</b>	<b>B</b>	<b>C</b>	<b>D</b>	<b>E</b>	<b>F</b>	<b>G</b>	<b>H</b>			

**HOW TO ORDER**

- Indicate the following information on order form:
- Quantity of each item.
  - Model number, including options. See "How To Build a Model Number".
  - Any special service required.

Note: • The  indicates that a choice is required.  
 • The absence of the  indicates that no choice is required.  
 • Alpha-numeric characters in place of  indicate that no other alternatives are available.

**HOW TO BUILD A MODEL NUMBER**

- A** Select basic model.
- B** Select non-contrast or fabric contrast 1. Refer to [ki.com/fabrics](http://ki.com/fabrics).  
 • For yardage pricing, see Fabric Yardage Pricing page
- C** Select fabric contrast 2. Refer to [ki.com/fabrics](http://ki.com/fabrics).  
 • For yardage pricing, see Fabric Yardage Pricing page
- D** Select base finish color. Refer to the **Product Color Options** page in this price list.
- E** Select armcaps.  
**PACBL** - Black poly armcap; add \$94  
**PACSA** - Sand poly; add \$94  
**PACWG** - Warm Grey poly; add \$94  
**WAC** - Wood armcaps (pair)  
**SAC** - Solid surface armcaps; add \$706 Upcharge for four armcaps.

Solid surface armcap color is always Corian™ white.

- F** Select wood finish color. Refer to the **Product Color Options** page in this price list. Wood finish selection is for wood armcaps. For Kensington Maple add upcharge.
- G** Select nylon glide color.  
**NGFN** - Flannel (Dark Grey)  
**NGNT** - Natural (Cream)
- H** Select moisture barrier.  
**MB** - Moisture barrier  
**NMB** - No moisture barrier  
 See pricing column for moisture barrier upcharge.

**KENSINGTON MAPLE UPCHARGE**

Kensington Maple requires extended leadtimes.  
 Model  
 All variations of Bariatric Models:  
 SOMB \$63  
 SPMB \$63

All variations of Loveseat Models:  
 SOM33 \$63  
 SPM33 \$63

All variations of Spanner Models:  
 SOM3S \$125  
 SPM3S \$125

**SPECIAL SERVICES****Special Carton Marking**

With specially marked information N/C

**Shipping**  
 Ships assembled, FOB High Point, NC 27263, freight prepaid. Freight class 175

Specifications and prices are subject to change without prior notice.

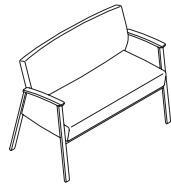
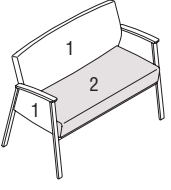

Features	MODEL NUMBER								Approx. Packaged Weight	Delivered Pricing	Moisture Barrier add to list price	
	Basic Model	Non-Contrast or Fabric Contrast 1	Fabric Contrast 2	Base Finish	Arm Cap	Wood Finish	Glide Color	Moist. Barrier				
 <p>SMML Loveseat (Closed Arm) Non-Contrast</p> <ul style="list-style-type: none"> <li>Non-contrast C.O.M = 3.25 yd</li> </ul>	No Connector	SPM33/NC	<input type="checkbox"/> <input type="checkbox"/> <input type="checkbox"/> <input type="checkbox"/>		<input type="checkbox"/> <input type="checkbox"/>	<input type="checkbox"/> <input type="checkbox"/>	<input type="checkbox"/> <input type="checkbox"/>	<input type="checkbox"/> <input type="checkbox"/>	<input type="checkbox"/> <input type="checkbox"/>	105.00#	\$ 2982	\$ 281
	Left Facing Chair Connector	SPM33LC/NC	<input type="checkbox"/> <input type="checkbox"/> <input type="checkbox"/> <input type="checkbox"/>		<input type="checkbox"/> <input type="checkbox"/>	<input type="checkbox"/> <input type="checkbox"/>	<input type="checkbox"/> <input type="checkbox"/>	<input type="checkbox"/> <input type="checkbox"/>	<input type="checkbox"/> <input type="checkbox"/>	105.00#	2982	281
	Right Facing Chair Connector	SPM33RC/NC	<input type="checkbox"/> <input type="checkbox"/> <input type="checkbox"/> <input type="checkbox"/>		<input type="checkbox"/> <input type="checkbox"/>	<input type="checkbox"/> <input type="checkbox"/>	<input type="checkbox"/> <input type="checkbox"/>	<input type="checkbox"/> <input type="checkbox"/>	<input type="checkbox"/> <input type="checkbox"/>	105.00#	2982	281
	Left and Right Facing Chair Connector	SPM33LCRC/NC	<input type="checkbox"/> <input type="checkbox"/> <input type="checkbox"/> <input type="checkbox"/>		<input type="checkbox"/> <input type="checkbox"/>	<input type="checkbox"/> <input type="checkbox"/>	<input type="checkbox"/> <input type="checkbox"/>	<input type="checkbox"/> <input type="checkbox"/>	<input type="checkbox"/> <input type="checkbox"/>	105.00#	2982	281
 <p>SMML Loveseat (Closed Arm) Contrast</p> <ul style="list-style-type: none"> <li>1 = Back and arms (Fabric Contrast 1) C.O.M. = 2.5 yd</li> <li>2 = Seat (Fabric Contrast 2) C.O.M. = 1.25 yd</li> </ul>	No Connector	SPM33/FC	<input type="checkbox"/> <input type="checkbox"/> <input type="checkbox"/> <input type="checkbox"/>	<input type="checkbox"/> <input type="checkbox"/> <input type="checkbox"/> <input type="checkbox"/>	<input type="checkbox"/> <input type="checkbox"/>	<input type="checkbox"/> <input type="checkbox"/>	<input type="checkbox"/> <input type="checkbox"/>	<input type="checkbox"/> <input type="checkbox"/>	<input type="checkbox"/> <input type="checkbox"/>	105.00#	\$ 3064	\$ 281
	Left Facing Chair Connector	SPM33LC/FC	<input type="checkbox"/> <input type="checkbox"/> <input type="checkbox"/> <input type="checkbox"/>	<input type="checkbox"/> <input type="checkbox"/> <input type="checkbox"/> <input type="checkbox"/>	<input type="checkbox"/> <input type="checkbox"/>	<input type="checkbox"/> <input type="checkbox"/>	<input type="checkbox"/> <input type="checkbox"/>	<input type="checkbox"/> <input type="checkbox"/>	<input type="checkbox"/> <input type="checkbox"/>	105.00#	3064	281
	Right Facing Chair Connector	SPM33RC/FC	<input type="checkbox"/> <input type="checkbox"/> <input type="checkbox"/> <input type="checkbox"/>	<input type="checkbox"/> <input type="checkbox"/> <input type="checkbox"/> <input type="checkbox"/>	<input type="checkbox"/> <input type="checkbox"/>	<input type="checkbox"/> <input type="checkbox"/>	<input type="checkbox"/> <input type="checkbox"/>	<input type="checkbox"/> <input type="checkbox"/>	<input type="checkbox"/> <input type="checkbox"/>	105.00#	3064	281
	Left and Right Facing Chair Connector	SPM33LCRC/FC	<input type="checkbox"/> <input type="checkbox"/> <input type="checkbox"/> <input type="checkbox"/>	<input type="checkbox"/> <input type="checkbox"/> <input type="checkbox"/> <input type="checkbox"/>	<input type="checkbox"/> <input type="checkbox"/>	<input type="checkbox"/> <input type="checkbox"/>	<input type="checkbox"/> <input type="checkbox"/>	<input type="checkbox"/> <input type="checkbox"/>	<input type="checkbox"/> <input type="checkbox"/>	105.00#	3064	281
			<b>A</b>	<b>B</b>	<b>C</b>	<b>D</b>	<b>E</b>	<b>F</b>	<b>G</b>	<b>H</b>		

**HOW TO ORDER**

- Indicate the following information on order form:
- Quantity of each item.
  - Model number, including options. See "How To Build a Model Number".
  - Any special service required.

Note:

- The  indicates that a choice is required.
- The absence of the  indicates that no choice is required.
- Alpha-numeric characters in place of  indicate that no other alternatives are available.

**HOW TO BUILD A MODEL NUMBER**

- A** Select basic model.
- B** Select non-contrast or fabric contrast 1. Refer to [ki.com/fabrics](http://ki.com/fabrics).
  - For yardage pricing, see Fabric Yardage Pricing page
- C** Select fabric contrast 2. Refer to [ki.com/fabrics](http://ki.com/fabrics).
  - For yardage pricing, see Fabric Yardage Pricing page
- D** Select base finish color. Refer to the **Product Color Options** page in this price list.
- E** Select armcaps.
  - PACBL** - Black poly armcap; add \$94
  - PACSA** - Sand poly; add \$94
  - PACWG** - Warm Grey poly; add \$94
  - WAC** - Wood armcaps (pair)
  - SAC** - Solid surface armcaps; add \$706 Upcharge for four armcaps.

Solid surface armcap color is always Corian™ white.

- F** Select wood finish color. Refer to the **Product Color Options** page in this price list. Wood finish selection is for wood armcaps. For Kensington Maple add upcharge.
- G** Select nylon glide color.
  - NGFN** - Flannel (Dark Grey)
  - NGNT** - Natural (Cream)
- H** Select moisture barrier.
  - MB** - Moisture barrier
  - NMB** - No moisture barrier
 See pricing column for moisture barrier upcharge.

**KENSINGTON MAPLE UPCHARGE**

Kensington Maple requires extended leadtimes.

Model

All variations of Bariatric Models:

SOMB	\$63
SPMB	\$63

All variations of Loveseat Models:

SOM33	\$63
SPM33	\$63

All variations of Spanner Models:

SOM3S	\$125
SPM3S	\$125

**SPECIAL SERVICES**

**Special Carton Marking**

With specially marked information N/C

**Shipping**  
Ships assembled, FOB High Point, NC 27263, freight prepaid. Freight class 175

Specifications and prices are subject to change without prior notice.

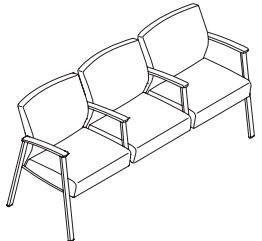
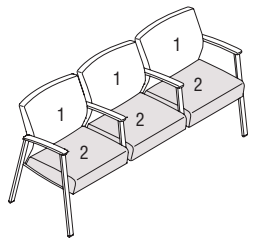

Features	MODEL NUMBER								Approx. Packaged Weight	Delivered Pricing	Moisture Barrier add to list price	
	Basic Model	Non-Contrast or Fabric Contrast 1	Fabric Contrast 2	Base Finish	Arm Cap	Wood Finish	Glide Color	Moist. Barrier				
 <p>SMMS <b>Three Seat Spanner (Open Arm) Non-Contrast</b> • Non-contrast C.O.M = 5 yd</p>	No Connector	SOM3S/NC	<input type="checkbox"/> <input type="checkbox"/> <input type="checkbox"/> <input type="checkbox"/>		<input type="checkbox"/> <input type="checkbox"/>	<input type="checkbox"/> <input type="checkbox"/>	<input type="checkbox"/> <input type="checkbox"/>	<input type="checkbox"/> <input type="checkbox"/>		140.00#	\$ 3875	\$ 279
	Left Facing Table Connector	SOM3SLT/NC	<input type="checkbox"/> <input type="checkbox"/> <input type="checkbox"/> <input type="checkbox"/>		<input type="checkbox"/> <input type="checkbox"/>	<input type="checkbox"/> <input type="checkbox"/>	<input type="checkbox"/> <input type="checkbox"/>	<input type="checkbox"/> <input type="checkbox"/>		140.00#	3875	279
	Right Facing Table Connector	SOM3SRT/NC	<input type="checkbox"/> <input type="checkbox"/> <input type="checkbox"/> <input type="checkbox"/>		<input type="checkbox"/> <input type="checkbox"/>	<input type="checkbox"/> <input type="checkbox"/>	<input type="checkbox"/> <input type="checkbox"/>	<input type="checkbox"/> <input type="checkbox"/>		140.00#	3875	279
	Left and Right Facing Table Connector	SOM3SLTRT/NC	<input type="checkbox"/> <input type="checkbox"/> <input type="checkbox"/> <input type="checkbox"/>		<input type="checkbox"/> <input type="checkbox"/>	<input type="checkbox"/> <input type="checkbox"/>	<input type="checkbox"/> <input type="checkbox"/>	<input type="checkbox"/> <input type="checkbox"/>		140.00#	3875	279
 <p>SMMS <b>Three Seat Spanner (Open Arm) Contrast</b> • 1 = Back (Fabric Contrast 1) C.O.M. = 3 yd • 2 = Seat (Fabric Contrast 2) C.O.M. = 2.25 yd</p>	No Connector	SOM3S/FC	<input type="checkbox"/> <input type="checkbox"/> <input type="checkbox"/> <input type="checkbox"/>	<input type="checkbox"/> <input type="checkbox"/> <input type="checkbox"/> <input type="checkbox"/>	<input type="checkbox"/> <input type="checkbox"/>	<input type="checkbox"/> <input type="checkbox"/>	<input type="checkbox"/> <input type="checkbox"/>	<input type="checkbox"/> <input type="checkbox"/>		140.00#	\$ 4030	\$ 279
	Left Facing Table Connector	SOM3SLT/FC	<input type="checkbox"/> <input type="checkbox"/> <input type="checkbox"/> <input type="checkbox"/>	<input type="checkbox"/> <input type="checkbox"/> <input type="checkbox"/> <input type="checkbox"/>	<input type="checkbox"/> <input type="checkbox"/>	<input type="checkbox"/> <input type="checkbox"/>	<input type="checkbox"/> <input type="checkbox"/>	<input type="checkbox"/> <input type="checkbox"/>		140.00#	4030	279
	Right Facing Table Connector	SOM3SRT/FC	<input type="checkbox"/> <input type="checkbox"/> <input type="checkbox"/> <input type="checkbox"/>	<input type="checkbox"/> <input type="checkbox"/> <input type="checkbox"/> <input type="checkbox"/>	<input type="checkbox"/> <input type="checkbox"/>	<input type="checkbox"/> <input type="checkbox"/>	<input type="checkbox"/> <input type="checkbox"/>	<input type="checkbox"/> <input type="checkbox"/>		140.00#	4030	279
	Left and Right Facing Table Connector	SOM3SLTRT/FC	<input type="checkbox"/> <input type="checkbox"/> <input type="checkbox"/> <input type="checkbox"/>	<input type="checkbox"/> <input type="checkbox"/> <input type="checkbox"/> <input type="checkbox"/>	<input type="checkbox"/> <input type="checkbox"/>	<input type="checkbox"/> <input type="checkbox"/>	<input type="checkbox"/> <input type="checkbox"/>	<input type="checkbox"/> <input type="checkbox"/>		140.00#	4030	279

**A** **B** **C** **D** **E** **F** **G** **H**

**HOW TO ORDER**

Indicate the following information on order form:  
 1. Quantity of each item.  
 2. Model number, including options. See "How To Build a Model Number".  
 3. Any special service required.

Note: • The  indicates that a choice is required.  
 • The absence of the  indicates that no choice is required.  
 • Alpha-numeric characters in place of  indicate that no other alternatives are available.

**HOW TO BUILD A MODEL NUMBER**

- A** Select basic model.
- B** Select non-contrast or fabric contrast 1. Refer to [ki.com/fabrics](http://ki.com/fabrics).  
 • For yardage pricing, see Fabric Yardage Pricing page
- C** Select fabric contrast 2. Refer to [ki.com/fabrics](http://ki.com/fabrics).  
 • For yardage pricing, see Fabric Yardage Pricing page
- D** Select base finish color. Refer to the **Product Color Options** page in this price list.
- E** Select armcaps.  
 PACBL - Black poly armcap; add \$189  
 PACSA - Sand poly; add \$189  
 PACWG - Warm Grey poly; add \$189  
 WAC - Wood armcaps (pair)  
 SAC - Solid surface armcaps; add \$1328  
 Upcharge for four armcaps.

Solid surface armcap color is always Corian™ white.

**F** Select wood finish color. Refer to the **Product Color Options** page in this price list. Wood finish selection is for wood armcaps. For Kensington Maple add upcharge.

**G** Select nylon glide color.  
 NGFN - Flannel (Dark Grey)  
 NGNT - Natural (Cream)

**H** Select moisture barrier.  
 MB - Moisture barrier  
 NMB - No moisture barrier  
 See pricing column for moisture barrier upcharge.

**KENSINGTON MAPLE UPCHARGE**

Kensington Maple requires extended leadtimes.  
 Model  
 All variations of Bariatric Models:  
 SOMB \$63  
 SPMB \$63  
  
 All variations of Loveseat Models:  
 SOM33 \$63  
 SPM33 \$63  
  
 All variations of Spanner Models:  
 SOM3S \$125  
 SPM3S \$125

**SPECIAL SERVICES**

**Special Carton Marking**  
 With specially marked information N/C  
  
**Shipping**  
 Ships assembled, FOB High Point, NC 27263, freight prepaid. Freight class 175  
  
 Specifications and prices are subject to change without prior notice.

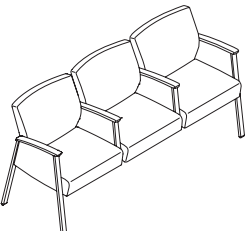
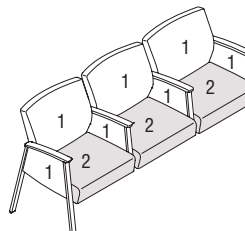

Features	MODEL NUMBER								Approx. Packaged Weight	Delivered Pricing	Moisture Barrier add to list price
	Basic Model	Non-Contrast or Fabric Contrast 1	Fabric Contrast 2	Base Finish	Arm Cap	Wood Finish	Glide Color	Moist. Barrier			
 SMMS <b>Three Seat Spanner (Closed Arm) Non-Contrast</b> • Non-contrast C.O.M = 5.75 yd	No Connector	SPM3S/NC	<input type="checkbox"/> <input type="checkbox"/> <input type="checkbox"/> <input type="checkbox"/>		<input type="checkbox"/> <input type="checkbox"/>	<input type="checkbox"/> <input type="checkbox"/>	<input type="checkbox"/> <input type="checkbox"/>	<input type="checkbox"/> <input type="checkbox"/>	150.00#	\$ 4406	\$ 301
	Left Facing Table Connector	SPM3SLT/NC	<input type="checkbox"/> <input type="checkbox"/> <input type="checkbox"/> <input type="checkbox"/>		<input type="checkbox"/> <input type="checkbox"/>	<input type="checkbox"/> <input type="checkbox"/>	<input type="checkbox"/> <input type="checkbox"/>	<input type="checkbox"/> <input type="checkbox"/>	150.00#	4406	301
	Right Facing Table Connector	SPM3SRT/NC	<input type="checkbox"/> <input type="checkbox"/> <input type="checkbox"/> <input type="checkbox"/>		<input type="checkbox"/> <input type="checkbox"/>	<input type="checkbox"/> <input type="checkbox"/>	<input type="checkbox"/> <input type="checkbox"/>	<input type="checkbox"/> <input type="checkbox"/>	150.00#	4406	301
	Left and Right Facing Table Connector	SPM3SLTRT/NC	<input type="checkbox"/> <input type="checkbox"/> <input type="checkbox"/> <input type="checkbox"/>		<input type="checkbox"/> <input type="checkbox"/>	<input type="checkbox"/> <input type="checkbox"/>	<input type="checkbox"/> <input type="checkbox"/>	<input type="checkbox"/> <input type="checkbox"/>	150.00#	4406	301
 SMMS <b>Three Seat Spanner (Closed Arm) Contrast</b> • 1 = Back and arms (Fabric Contrast 1) C.O.M. = 4 yd • 2 = Seat (Fabric Contrast 2) C.O.M. = 2.25 yd	No Connector	SPM3S/FC	<input type="checkbox"/> <input type="checkbox"/> <input type="checkbox"/> <input type="checkbox"/>	<input type="checkbox"/> <input type="checkbox"/> <input type="checkbox"/> <input type="checkbox"/>	<input type="checkbox"/> <input type="checkbox"/>	<input type="checkbox"/> <input type="checkbox"/>	<input type="checkbox"/> <input type="checkbox"/>	<input type="checkbox"/> <input type="checkbox"/>	150.00#	\$ 4561	\$ 301
	Left Facing Table Connector	SPM3SLT/FC	<input type="checkbox"/> <input type="checkbox"/> <input type="checkbox"/> <input type="checkbox"/>	<input type="checkbox"/> <input type="checkbox"/> <input type="checkbox"/> <input type="checkbox"/>	<input type="checkbox"/> <input type="checkbox"/>	<input type="checkbox"/> <input type="checkbox"/>	<input type="checkbox"/> <input type="checkbox"/>	<input type="checkbox"/> <input type="checkbox"/>	150.00#	4561	301
	Right Facing Table Connector	SPM3SRT/FC	<input type="checkbox"/> <input type="checkbox"/> <input type="checkbox"/> <input type="checkbox"/>	<input type="checkbox"/> <input type="checkbox"/> <input type="checkbox"/> <input type="checkbox"/>	<input type="checkbox"/> <input type="checkbox"/>	<input type="checkbox"/> <input type="checkbox"/>	<input type="checkbox"/> <input type="checkbox"/>	<input type="checkbox"/> <input type="checkbox"/>	150.00#	4561	301
	Left and Right Facing Table Connector	SPM3SLTRT/FC	<input type="checkbox"/> <input type="checkbox"/> <input type="checkbox"/> <input type="checkbox"/>	<input type="checkbox"/> <input type="checkbox"/> <input type="checkbox"/> <input type="checkbox"/>	<input type="checkbox"/> <input type="checkbox"/>	<input type="checkbox"/> <input type="checkbox"/>	<input type="checkbox"/> <input type="checkbox"/>	<input type="checkbox"/> <input type="checkbox"/>	150.00#	4561	301

**A B C D E F G H**

**HOW TO ORDER**

- Indicate the following information on order form:
- Quantity of each item.
  - Model number, including options. See "How To Build a Model Number".
  - Any special service required.

Note: • The  indicates that a choice is required.  
 • The absence of the  indicates that no choice is required.  
 • Alpha-numeric characters in place of  indicate that no other alternatives are available.

**HOW TO BUILD A MODEL NUMBER**

- A** Select basic model.
- B** Select non-contrast or fabric contrast 1. Refer to [ki.com/fabrics](http://ki.com/fabrics).  
 • For yardage pricing, see Fabric Yardage Pricing page
- C** Select fabric contrast 2. Refer to [ki.com/fabrics](http://ki.com/fabrics).  
 • For yardage pricing, see Fabric Yardage Pricing page
- D** Select base finish color. Refer to the **Product Color Options** page in this price list.
- E** Select armcaps.  
 PACBL - Black poly armcap; add \$189  
 PACSA - Sand poly; add \$189  
 PACWG - Warm Grey poly; add \$189  
 WAC - Wood armcaps (pair)  
 SAC - Solid surface armcaps; add \$1328  
 Upcharge for four armcaps.

Solid surface armcap color is always Corian™ white.

- F** Select wood finish color. Refer to the **Product Color Options** page in this price list. Wood finish selection is for wood armcaps. For Kensington Maple add upcharge.
- G** Select nylon glide color.  
 NGFN - Flannel (Dark Grey)  
 NGNT - Natural (Cream)
- H** Select moisture barrier.  
 MB - Moisture barrier  
 NMB - No moisture barrier  
 See pricing column for moisture barrier upcharge.

**KENSINGTON MAPLE UPCHARGE**

Kensington Maple requires extended leadtimes.

Model  
 All variations of Bariatric Models:  
 SOMB \$63  
 SPMB \$63

All variations of Loveseat Models:  
 SOM33 \$63  
 SPM33 \$63

All variations of Spanner Models:  
 SOM3S \$125  
 SPM3S \$125

**SPECIAL SERVICES**

**Special Carton Marking**  
 With specially marked information N/C

**Shipping**  
 Ships assembled, FOB High Point, NC 27263, freight prepaid. Freight class 175

Specifications and prices are subject to change without prior notice.

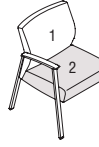

MODEL	Features	MODEL NUMBER								Approx. Packaged Weight	Delivered Pricing	Moisture Barrier add to list price
		Basic Model	Non-Contrast or Fabric Contrast 1	Fabric Contrast 2	Base Finish	Arm Cap	Wood Finish	Glide Color	Moist. Barrier			
 SMAMC <b>One Seat Add-on Unit - Left Facing (Open Arm) Non-Contrast</b> • Non-contrast C.O.M = 1.5 yd	No Connector	SOMACL/NC	<input type="checkbox"/> <input type="checkbox"/> <input type="checkbox"/> <input type="checkbox"/>		<input type="checkbox"/> <input type="checkbox"/>	<input type="checkbox"/> <input type="checkbox"/>	<input type="checkbox"/> <input type="checkbox"/>	<input type="checkbox"/> <input type="checkbox"/>	<input type="checkbox"/> <input type="checkbox"/>	45.00#	\$ 1365	\$ 229
	Left Chair Connector	SOMACLC/NC	<input type="checkbox"/> <input type="checkbox"/> <input type="checkbox"/> <input type="checkbox"/>		<input type="checkbox"/> <input type="checkbox"/>	<input type="checkbox"/> <input type="checkbox"/>	<input type="checkbox"/> <input type="checkbox"/>	<input type="checkbox"/> <input type="checkbox"/>	<input type="checkbox"/> <input type="checkbox"/>	45.00#	1365	229
 SMAMC <b>One Seat Add-on Unit - Left Facing (Open Arm) Contrast</b> • 1 = Back (Fabric Contrast 1) C.O.M. = 1.25 yd • 2 = Seat (Fabric Contrast 2) C.O.M. = 1 yd	No Connector	SOMACL/FC	<input type="checkbox"/> <input type="checkbox"/> <input type="checkbox"/> <input type="checkbox"/>	<input type="checkbox"/> <input type="checkbox"/> <input type="checkbox"/> <input type="checkbox"/>	<input type="checkbox"/> <input type="checkbox"/>	<input type="checkbox"/> <input type="checkbox"/>	<input type="checkbox"/> <input type="checkbox"/>	<input type="checkbox"/> <input type="checkbox"/>	<input type="checkbox"/> <input type="checkbox"/>	45.00#	\$ 1428	\$ 229
	Left Chair Connector	SOMACLC/FC	<input type="checkbox"/> <input type="checkbox"/> <input type="checkbox"/> <input type="checkbox"/>	<input type="checkbox"/> <input type="checkbox"/> <input type="checkbox"/> <input type="checkbox"/>	<input type="checkbox"/> <input type="checkbox"/>	<input type="checkbox"/> <input type="checkbox"/>	<input type="checkbox"/> <input type="checkbox"/>	<input type="checkbox"/> <input type="checkbox"/>	<input type="checkbox"/> <input type="checkbox"/>	45.00#	1428	229

**A B C D E F G H**

**HOW TO ORDER**

- Indicate the following information on order form:
- Quantity of each item.
  - Model number, including options. See "How To Build a Model Number".
  - Any special service required.

Note: • The  indicates that a choice is required.  
 • The absence of the  indicates that no choice is required.  
 • Alpha-numeric characters in place of  indicate that no other alternatives are available.

**HOW TO BUILD A MODEL NUMBER**

- A** Select basic model.
- B** Select non-contrast or fabric contrast 1. Refer to [ki.com/fabrics](http://ki.com/fabrics).
  - For yardage pricing, see Fabric Yardage Pricing page
- C** Select fabric contrast 2. Refer to [ki.com/fabrics](http://ki.com/fabrics).
  - For yardage pricing, see Fabric Yardage Pricing page
- D** Select base finish color. Refer to the **Product Color Options** page in this price list.
- E** Select armcaps.
  - PACBL** - Black poly armcap; add \$47
  - PACSA** - Sand poly; add \$47
  - PACWG** - Warm Grey poly; add \$47
  - WAC** - Wood armcaps (pair)
  - SAC** - Solid surface armcaps; add \$431 Upcharge for one armcap.

Solid surface armcap color is always Corian™ white.

- F** Select wood finish color. Refer to the **Product Color Options** page in this price list. Wood finish selection is for wood armcaps. For Kensington Maple add upcharge.
- G** Select nylon glide color.
  - NGFN** - Flannel (Dark Grey)
  - NGNT** - Natural (Cream)
- H** Select moisture barrier.
  - MB** - Moisture barrier
  - NMB** - No moisture barrier
 See pricing column for moisture barrier upcharge.

**KENSINGTON MAPLE UPCHARGE**

Kensington Maple requires extended leadtimes. Model All variations of One Seat Add-on Models:

SOMACL	\$33
SOMACR	\$33
SPMACL	\$33
SPMACR	\$33

**SPECIAL SERVICES**

**Special Carton Marking**  
 With specially marked information N/C

**Shipping**  
 Ships assembled, FOB High Point, NC 27263, freight prepaid. Freight class 175

Specifications and prices are subject to change without prior notice.

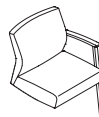
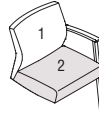

MODEL	Features	MODEL NUMBER								Approx. Packaged Weight	Delivered Pricing	Moisture Barrier add to list price
		Basic Model	Non-Contrast or Fabric Contrast 1	Fabric Contrast 2	Base Finish	Arm Cap	Wood Finish	Glide Color	Moist. Barrier			
 SMAMC <b>One Seat Add-on Unit - Right Facing (Open Arm) Non-Contrast</b> • Non-contrast C.O.M = 1.5 yd	No Connector	SOMACR/NC	<input type="checkbox"/> <input type="checkbox"/> <input type="checkbox"/> <input type="checkbox"/>		<input type="checkbox"/> <input type="checkbox"/>	<input type="checkbox"/> <input type="checkbox"/>	<input type="checkbox"/> <input type="checkbox"/>	<input type="checkbox"/> <input type="checkbox"/>	<input type="checkbox"/> <input type="checkbox"/>	45.00#	\$ 1365	\$ 229
	Right Chair Connector	SOMACRC/NC	<input type="checkbox"/> <input type="checkbox"/> <input type="checkbox"/> <input type="checkbox"/>		<input type="checkbox"/> <input type="checkbox"/>	<input type="checkbox"/> <input type="checkbox"/>	<input type="checkbox"/> <input type="checkbox"/>	<input type="checkbox"/> <input type="checkbox"/>	<input type="checkbox"/> <input type="checkbox"/>	45.00#	1365	229
 SMAMC <b>One Seat Add-on Unit - Right Facing (Open Arm) Contrast</b> • 1 = Back (Fabric Contrast 1) C.O.M. = 1.25 yd • 2 = Seat (Fabric Contrast 2) C.O.M. = 1 yd	No Connector	SOMACR/FC	<input type="checkbox"/> <input type="checkbox"/> <input type="checkbox"/> <input type="checkbox"/>	<input type="checkbox"/> <input type="checkbox"/> <input type="checkbox"/> <input type="checkbox"/>	<input type="checkbox"/> <input type="checkbox"/>	<input type="checkbox"/> <input type="checkbox"/>	<input type="checkbox"/> <input type="checkbox"/>	<input type="checkbox"/> <input type="checkbox"/>	<input type="checkbox"/> <input type="checkbox"/>	45.00#	\$ 1428	\$ 229
	Right Chair Connector	SOMACRC/FC	<input type="checkbox"/> <input type="checkbox"/> <input type="checkbox"/> <input type="checkbox"/>	<input type="checkbox"/> <input type="checkbox"/> <input type="checkbox"/> <input type="checkbox"/>	<input type="checkbox"/> <input type="checkbox"/>	<input type="checkbox"/> <input type="checkbox"/>	<input type="checkbox"/> <input type="checkbox"/>	<input type="checkbox"/> <input type="checkbox"/>	<input type="checkbox"/> <input type="checkbox"/>	45.00#	1428	229
			<b>A</b>	<b>B</b>	<b>C</b>	<b>D</b>	<b>E</b>	<b>F</b>	<b>G</b>	<b>H</b>		

**HOW TO ORDER**

- Indicate the following information on order form:
- Quantity of each item.
  - Model number, including options. See "How To Build a Model Number".
  - Any special service required.

Note: • The  indicates that a choice is required.  
 • The absence of the  indicates that no choice is required.  
 • Alpha-numeric characters in place of  indicate that no other alternatives are available.

**HOW TO BUILD A MODEL NUMBER**

- A** Select basic model.
- B** Select non-contrast or fabric contrast 1. Refer to [ki.com/fabrics](http://ki.com/fabrics).  
 • For yardage pricing, see Fabric Yardage Pricing page
- C** Select fabric contrast 2. Refer to [ki.com/fabrics](http://ki.com/fabrics).  
 • For yardage pricing, see Fabric Yardage Pricing page
- D** Select base finish color. Refer to the **Product Color Options** page in this price list.
- E** Select armcaps.
  - PACBL** - Black poly armcap; add \$47
  - PACSA** - Sand poly; add \$47
  - PACWG** - Warm Grey poly; add \$47
  - WAC** - Wood armcaps (pair)
  - SAC** - Solid surface armcaps; add \$431 Upcharge for one armcap.

Solid surface armcap color is always Corian™ white.

- F** Select wood finish color. Refer to the **Product Color Options** page in this price list. Wood finish selection is for wood armcaps. For Kensington Maple add upcharge.
- G** Select nylon glide color.
  - NGFN** - Flannel (Dark Grey)
  - NGNT** - Natural (Cream)
- H** Select moisture barrier.
  - MB** - Moisture barrier
  - NMB** - No moisture barrier
 See pricing column for moisture barrier upcharge.

**KENSINGTON MAPLE UPCHARGE**

Kensington Maple requires extended leadtimes. Model All variations of One Seat Add-on Models:

SOMACL	\$33
SOMACR	\$33
SPMACL	\$33
SPMACR	\$33

**SPECIAL SERVICES**

**Special Carton Marking**

With specially marked information N/C

**Shipping**  
 Ships **assembled, FOB High Point, NC 27263, freight prepaid.** Freight class 175

Specifications and prices are subject to change without prior notice.

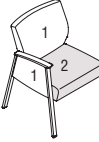

MODEL	Features	MODEL NUMBER								Approx. Packaged Weight	Delivered Pricing	Moisture Barrier add to list price
		Basic Model	Non-Contrast or Fabric Contrast 1	Fabric Contrast 2	Base Finish	Arm Cap	Wood Finish	Glide Color	Moist. Barrier			
 <p><b>One Seat Add-on Unit - Left Facing (Closed Arm) Non-Contrast</b> • Non-contrast C.O.M = 2.25 yd</p>	No Connector	SPMACL/NC	<input type="checkbox"/> <input type="checkbox"/> <input type="checkbox"/> <input type="checkbox"/>		<input type="checkbox"/> <input type="checkbox"/>	<input type="checkbox"/> <input type="checkbox"/>	<input type="checkbox"/> <input type="checkbox"/>	<input type="checkbox"/> <input type="checkbox"/>	<input type="checkbox"/> <input type="checkbox"/>	45.00#	\$ 1550	\$ 240
	Left Chair Connector	SPMACLC/NC	<input type="checkbox"/> <input type="checkbox"/> <input type="checkbox"/> <input type="checkbox"/>		<input type="checkbox"/> <input type="checkbox"/>	<input type="checkbox"/> <input type="checkbox"/>	<input type="checkbox"/> <input type="checkbox"/>	<input type="checkbox"/> <input type="checkbox"/>	<input type="checkbox"/> <input type="checkbox"/>	<input type="checkbox"/> <input type="checkbox"/>	45.00#	1550
SMAMC												
 <p><b>One Seat Add-on Unit - Left Facing (Closed Arm) Contrast</b> • 1 = Back and arms (Fabric Contrast 1) C.O.M. = 1.75 yd • 2 = Seat (Fabric Contrast 2) C.O.M. = 1 yd</p>	No Connector	SPMACL/FC	<input type="checkbox"/> <input type="checkbox"/> <input type="checkbox"/> <input type="checkbox"/>	<input type="checkbox"/> <input type="checkbox"/> <input type="checkbox"/> <input type="checkbox"/>	<input type="checkbox"/> <input type="checkbox"/>	<input type="checkbox"/> <input type="checkbox"/>	<input type="checkbox"/> <input type="checkbox"/>	<input type="checkbox"/> <input type="checkbox"/>	<input type="checkbox"/> <input type="checkbox"/>	45.00#	\$ 1612	\$ 240
	Left Chair Connector	SPMACLC/FC	<input type="checkbox"/> <input type="checkbox"/> <input type="checkbox"/> <input type="checkbox"/>	<input type="checkbox"/> <input type="checkbox"/> <input type="checkbox"/> <input type="checkbox"/>	<input type="checkbox"/> <input type="checkbox"/>	<input type="checkbox"/> <input type="checkbox"/>	<input type="checkbox"/> <input type="checkbox"/>	<input type="checkbox"/> <input type="checkbox"/>	<input type="checkbox"/> <input type="checkbox"/>	<input type="checkbox"/> <input type="checkbox"/>	45.00#	1612
SMAMC												

**A B C D E F G H**

**HOW TO ORDER**

- Indicate the following information on order form:
- Quantity of each item.
  - Model number, including options. See "How To Build a Model Number".
  - Any special service required.

Note:

- The  indicates that a choice is required.
- The absence of the  indicates that no choice is required.
- Alpha-numeric characters in place of  indicate that no other alternatives are available.

**HOW TO BUILD A MODEL NUMBER**

- A** Select basic model.
- B** Select non-contrast or fabric contrast 1. Refer to [ki.com/fabrics](http://ki.com/fabrics).
  - For yardage pricing, see Fabric Yardage Pricing page
- C** Select fabric contrast 2. Refer to [ki.com/fabrics](http://ki.com/fabrics).
  - For yardage pricing, see Fabric Yardage Pricing page
- D** Select base finish color. Refer to the **Product Color Options** page in this price list.
- E** Select armcaps.
  - PACBL** - Black poly armcap; add \$47
  - PACSA** - Sand poly; add \$47
  - PACWG** - Warm Grey poly; add \$47
  - WAC** - Wood armcaps (pair)
  - SAC** - Solid surface armcaps; add \$431 Upcharge for one armcap.

Solid surface armcap color is always Corian™ white.

- F** Select wood finish color. Refer to the **Product Color Options** page in this price list. Wood finish selection is for wood armcaps. For Kensington Maple add upcharge.
- G** Select nylon glide color.
  - NGFN** - Flannel (Dark Grey)
  - NGNT** - Natural (Cream)
- H** Select moisture barrier.
  - MB** - Moisture barrier
  - NMB** - No moisture barrier
 See pricing column for moisture barrier upcharge.

**KENSINGTON MAPLE UPCHARGE**

Kensington Maple requires extended leadtimes. Model All variations of One Seat Add-on Models:

SOMACL	\$33
SOMACR	\$33
SPMACL	\$33
SPMACR	\$33

**SPECIAL SERVICES**

**Special Carton Marking**

With specially marked information N/C

**Shipping**  
Ships **assembled, FOB High Point, NC 27263, freight prepaid.** Freight class 175

Specifications and prices are subject to change without prior notice.

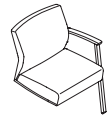
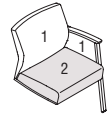

MODEL	Features	MODEL NUMBER								Approx. Packaged Weight	Delivered Pricing	Moisture Barrier add to list price
		Basic Model	Non-Contrast or Fabric Contrast 1	Fabric Contrast 2	Base Finish	Arm Cap	Wood Finish	Glide Color	Moist. Barrier			
 One Seat Add-on Unit - Right Facing (Closed Arm) Non-Contrast • Non-contrast C.O.M = 2.25 yd	No Connector	SPMACR/NC	<input type="checkbox"/> <input type="checkbox"/> <input type="checkbox"/> <input type="checkbox"/>		<input type="checkbox"/> <input type="checkbox"/>	<input type="checkbox"/> <input type="checkbox"/>	<input type="checkbox"/> <input type="checkbox"/>	<input type="checkbox"/> <input type="checkbox"/>	<input type="checkbox"/> <input type="checkbox"/>	45.00#	\$ 1550	\$ 240
	Right Chair Connector	SPMACRC/NC	<input type="checkbox"/> <input type="checkbox"/> <input type="checkbox"/> <input type="checkbox"/>		<input type="checkbox"/> <input type="checkbox"/>	<input type="checkbox"/> <input type="checkbox"/>	<input type="checkbox"/> <input type="checkbox"/>	<input type="checkbox"/> <input type="checkbox"/>	<input type="checkbox"/> <input type="checkbox"/>	<input type="checkbox"/> <input type="checkbox"/>	45.00#	1550
SMAMC												
 One Seat Add-on Unit - Right Facing (Closed Arm) Contrast • 1 = Back and arms (Fabric Contrast 1) C.O.M. = 1.75 yd • 2 = Seat (Fabric Contrast 2) C.O.M. = 1 yd	No Connector	SPMACR/FC	<input type="checkbox"/> <input type="checkbox"/> <input type="checkbox"/> <input type="checkbox"/>	<input type="checkbox"/> <input type="checkbox"/> <input type="checkbox"/> <input type="checkbox"/>	<input type="checkbox"/> <input type="checkbox"/>	<input type="checkbox"/> <input type="checkbox"/>	<input type="checkbox"/> <input type="checkbox"/>	<input type="checkbox"/> <input type="checkbox"/>	<input type="checkbox"/> <input type="checkbox"/>	45.00#	\$ 1612	\$ 240
	Right Chair Connector	SPMACRC/FC	<input type="checkbox"/> <input type="checkbox"/> <input type="checkbox"/> <input type="checkbox"/>	<input type="checkbox"/> <input type="checkbox"/> <input type="checkbox"/> <input type="checkbox"/>	<input type="checkbox"/> <input type="checkbox"/>	<input type="checkbox"/> <input type="checkbox"/>	<input type="checkbox"/> <input type="checkbox"/>	<input type="checkbox"/> <input type="checkbox"/>	<input type="checkbox"/> <input type="checkbox"/>	<input type="checkbox"/> <input type="checkbox"/>	45.00#	1612
SMAMC												

**A** **B** **C** **D** **E** **F** **G** **H**

**HOW TO ORDER**

- Indicate the following information on order form:
- Quantity of each item.
  - Model number, including options. See "How To Build a Model Number".
  - Any special service required.

Note: • The  indicates that a choice is required.  
 • The absence of the  indicates that no choice is required.  
 • Alpha-numeric characters in place of  indicate that no other alternatives are available.

**HOW TO BUILD A MODEL NUMBER**

- A** Select basic model.
- B** Select non-contrast or fabric contrast 1. Refer to [ki.com/fabrics](http://ki.com/fabrics).
  - For yardage pricing, see Fabric Yardage Pricing page
- C** Select fabric contrast 2. Refer to [ki.com/fabrics](http://ki.com/fabrics).
  - For yardage pricing, see Fabric Yardage Pricing page
- D** Select base finish color. Refer to the **Product Color Options** page in this price list.
- E** Select armcaps.
  - PACBL** - Black poly armcap; add \$47
  - PACSA** - Sand poly; add \$47
  - PACWG** - Warm Grey poly; add \$47
  - WAC** - Wood armcaps (pair)
  - SAC** - Solid surface armcaps; add \$431 Upcharge for one armcap.

Solid surface armcap color is always Corian™ white.

- F** Select wood finish color. Refer to the **Product Color Options** page in this price list. Wood finish selection is for wood armcaps. For Kensington Maple add upcharge.
- G** Select nylon glide color.
  - NGFN** - Flannel (Dark Grey)
  - NGNT** - Natural (Cream)
- H** Select moisture barrier.
  - MB** - Moisture barrier
  - NMB** - No moisture barrier
 See pricing column for moisture barrier upcharge.

**KENSINGTON MAPLE UPCHARGE**

Kensington Maple requires extended leadtimes. Model All variations of One Seat Add-on Models:

SOMACL	\$33
SOMACR	\$33
SPMACL	\$33
SPMACR	\$33

**SPECIAL SERVICES**

**Special Carton Marking**

With specially marked information N/C

**Shipping**  
 Ships assembled, FOB High Point, NC 27263, freight prepaid. Freight class 175

Specifications and prices are subject to change without prior notice.

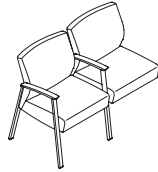
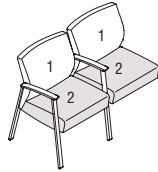

MODEL	Features	MODEL NUMBER								Approx. Packaged Weight	Delivered Pricing	Moisture Barrier add to list price
		Basic Model	Non-Contrast or Fabric Contrast 1	Fabric Contrast 2	Base Finish	Arm Cap	Wood Finish	Glide Color	Moist. Barrier			
 <b>Two Seat Add-on Unit - Left Facing (Open Arm) Non-Contrast</b> • Non-contrast C.O.M = 3 yd	No Connector	SOMACCL/NC	<input type="checkbox"/> <input type="checkbox"/> <input type="checkbox"/> <input type="checkbox"/>		<input type="checkbox"/> <input type="checkbox"/>	<input type="checkbox"/> <input type="checkbox"/>	<input type="checkbox"/> <input type="checkbox"/>	<input type="checkbox"/> <input type="checkbox"/>	<input type="checkbox"/> <input type="checkbox"/>	90.00#	\$ 2482	\$ 254
	Left Chair Connector	SOMACCLC/NC	<input type="checkbox"/> <input type="checkbox"/> <input type="checkbox"/> <input type="checkbox"/>		<input type="checkbox"/> <input type="checkbox"/>	<input type="checkbox"/> <input type="checkbox"/>	<input type="checkbox"/> <input type="checkbox"/>	<input type="checkbox"/> <input type="checkbox"/>	<input type="checkbox"/> <input type="checkbox"/>	90.00#	2482	254
SMAMC												
 <b>Two Seat Add-on Unit - Left Facing (Open Arm) Contrast</b> • 1 = Back (Fabric Contrast 1) C.O.M. = 2 yd • 2 = Seat (Fabric Contrast 2) C.O.M. = 2 yd	No Connector	SOMACCL/FC	<input type="checkbox"/> <input type="checkbox"/> <input type="checkbox"/> <input type="checkbox"/>	<input type="checkbox"/> <input type="checkbox"/> <input type="checkbox"/> <input type="checkbox"/>	<input type="checkbox"/> <input type="checkbox"/>	<input type="checkbox"/> <input type="checkbox"/>	<input type="checkbox"/> <input type="checkbox"/>	<input type="checkbox"/> <input type="checkbox"/>	<input type="checkbox"/> <input type="checkbox"/>	90.00#	\$ 2593	\$ 254
	Left Chair Connector	SOMACCLC/FC	<input type="checkbox"/> <input type="checkbox"/> <input type="checkbox"/> <input type="checkbox"/>	<input type="checkbox"/> <input type="checkbox"/> <input type="checkbox"/> <input type="checkbox"/>	<input type="checkbox"/> <input type="checkbox"/>	<input type="checkbox"/> <input type="checkbox"/>	<input type="checkbox"/> <input type="checkbox"/>	<input type="checkbox"/> <input type="checkbox"/>	<input type="checkbox"/> <input type="checkbox"/>	90.00#	2593	254
SMAMC												

**A** **B** **C** **D** **E** **F** **G** **H**

**HOW TO ORDER**

- Indicate the following information on order form:
- Quantity of each item.
  - Model number, including options. See "How To Build a Model Number".
  - Any special service required.

Note: • The  indicates that a choice is required.  
 • The absence of the  indicates that no choice is required.  
 • Alpha-numeric characters in place of  indicate that no other alternatives are available.

**HOW TO BUILD A MODEL NUMBER**

- A** Select basic model.
- B** Select non-contrast or fabric contrast 1. Refer to [ki.com/fabrics](http://ki.com/fabrics).
  - For yardage pricing, see Fabric Yardage Pricing page
- C** Select fabric contrast 2. Refer to [ki.com/fabrics](http://ki.com/fabrics).
  - For yardage pricing, see Fabric Yardage Pricing page
- D** Select base finish color. Refer to the **Product Color Options** page in this price list.
- E** Select armcaps.
  - PACBL** - Black poly armcap; add \$94
  - PACSA** - Sand poly; add \$94
  - PACWG** - Warm Grey poly; add \$94
  - WAC** - Wood armcaps (pair)
  - SAC** - Solid surface armcaps; add \$706 Upcharge for two armcaps.

Solid surface armcap color is always Corian™ white.

- F** Select wood finish color. Refer to the **Product Color Options** page in this price list. Wood finish selection is for wood armcaps. For Kensington Maple add upcharge.
- G** Select nylon glide color.
  - NGFN** - Flannel (Dark Grey)
  - NGNT** - Natural (Cream)
- H** Select moisture barrier.
  - MB** - Moisture barrier
  - NMB** - No moisture barrier
 See pricing column for moisture barrier upcharge.

**KENSINGTON MAPLE UPCHARGE**

Kensington Maple requires extended leadtimes. Model  
 All variations of Two Seat Add-on Models:

SOMACCL	\$63
SOMACCR	\$63
SPMACCL	\$63
SPMACCR	\$63

**SPECIAL SERVICES**

**Special Carton Marking**

With specially marked information N/C

**Shipping**  
 Ships **assembled, FOB High Point, NC 27263, freight prepaid.** Freight class 175

Specifications and prices are subject to change without prior notice.

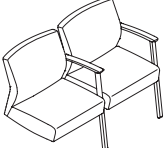
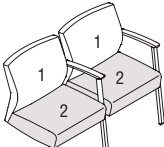

Features	MODEL NUMBER								Approx. Packaged Weight	Delivered Pricing	Moisture Barrier add to list price
	Basic Model	Non-Contrast or Fabric Contrast 1	Fabric Contrast 2	Base Finish	Arm Cap	Wood Finish	Glide Color	Moist. Barrier			
 No Connector Right Chair Connector	SOMACCR/NC	□□□□		□□	□□	□□	□□	□□	90.00#	\$ 2482	\$ 254
	SOMACCRC/NC	□□□□		□□	□□	□□	□□	□□	90.00#	2482	254
SMAMC <b>Two Seat Add-on Unit - Right Facing (Open Arm) Non-Contrast</b> • Non-contrast C.O.M = 3 yd											
 No Connector Right Chair Connector	SOMACCR/FC	□□□□	□□□□	□□	□□	□□	□□	□□	90.00#	\$ 2593	\$ 254
	SOMACCRC/FC	□□□□	□□□□	□□	□□	□□	□□	□□	90.00#	2593	254
SMAMC <b>Two Seat Add-on Unit - Right Facing (Open Arm) Contrast</b> • 1 = Back (Fabric Contrast 1) C.O.M. = 2 yd • 2 = Seat (Fabric Contrast 2) C.O.M. = 2 yd											
	<b>A</b>	<b>B</b>	<b>C</b>	<b>D</b>	<b>E</b>	<b>F</b>	<b>G</b>	<b>H</b>			

**HOW TO ORDER**

- Indicate the following information on order form:
- Quantity of each item.
  - Model number, including options. See "How To Build a Model Number".
  - Any special service required.

Note: • The □ indicates that a choice is required.  
 • The absence of the □ indicates that no choice is required.  
 • Alpha-numeric characters in place of □ indicate that no other alternatives are available.

**HOW TO BUILD A MODEL NUMBER**

- A** Select basic model.
- B** Select non-contrast or fabric contrast 1. Refer to [ki.com/fabrics](http://ki.com/fabrics).  
 • For yardage pricing, see Fabric Yardage Pricing page
- C** Select fabric contrast 2. Refer to [ki.com/fabrics](http://ki.com/fabrics).  
 • For yardage pricing, see Fabric Yardage Pricing page
- D** Select base finish color. Refer to the **Product Color Options** page in this price list.
- E** Select armcaps.
  - PACBL** - Black poly armcap; add \$94
  - PACSA** - Sand poly; add \$94
  - PACWG** - Warm Grey poly; add \$94
  - WAC** - Wood armcaps (pair)
  - SAC** - Solid surface armcaps; add \$706 Upcharge for two armcaps.

- Solid surface armcap color is always Corian™ white.
- F** Select wood finish color. Refer to the **Product Color Options** page in this price list. Wood finish selection is for wood armcaps. For Kensington Maple add upcharge.
- G** Select nylon glide color.
  - NGFN** - Flannel (Dark Grey)
  - NGNT** - Natural (Cream)
- H** Select moisture barrier.
  - MB** - Moisture barrier
  - NMB** - No moisture barrier
 See pricing column for moisture barrier upcharge.

**KENSINGTON MAPLE UPCHARGE**

Kensington Maple requires extended leadtimes. Model  
 All variations of Two Seat Add-on Models:

SOMACCL	\$63
SOMACCR	\$63
SPMACCL	\$63
SPMACCR	\$63

**SPECIAL SERVICES**

**Special Carton Marking**

With specially marked information N/C

**Shipping**  
 Ships assembled, FOB High Point, NC 27263, freight prepaid. Freight class 175

Specifications and prices are subject to change without prior notice.

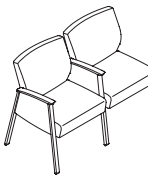
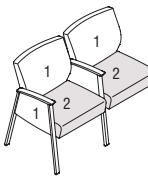

MODEL	Features	MODEL NUMBER								Approx. Packaged Weight	Delivered Pricing	Moisture Barrier add to list price
		Basic Model	Non-Contrast or Fabric Contrast 1	Fabric Contrast 2	Base Finish	Arm Cap	Wood Finish	Glide Color	Moist. Barrier			
 <p><b>Two Seat Add-on Unit - Left Facing (Closed Arm) Non-Contrast</b> • Non-contrast C.O.M = 4.25 yd</p>	No Connector	SPMACCL/NC	<input type="checkbox"/> <input type="checkbox"/> <input type="checkbox"/> <input type="checkbox"/>		<input type="checkbox"/> <input type="checkbox"/>	<input type="checkbox"/> <input type="checkbox"/>	<input type="checkbox"/> <input type="checkbox"/>	<input type="checkbox"/> <input type="checkbox"/>	<input type="checkbox"/> <input type="checkbox"/>	95.00#	\$ 2743	\$ 272
	Left Chair Connector	SPMACCLC/NC	<input type="checkbox"/> <input type="checkbox"/> <input type="checkbox"/> <input type="checkbox"/>		<input type="checkbox"/> <input type="checkbox"/>	<input type="checkbox"/> <input type="checkbox"/>	<input type="checkbox"/> <input type="checkbox"/>	<input type="checkbox"/> <input type="checkbox"/>	<input type="checkbox"/> <input type="checkbox"/>	95.00#	2743	272
SMAMC												
 <p><b>Two Seat Add-on Unit - Left Facing (Closed Arm) Contrast</b> • 1 = Back and arms (Fabric Contrast 1) C.O.M. = 3.25 yd • 2 = Seat (Fabric Contrast 2) C.O.M. = 1.5 yd</p>	No Connector	SPMACCL/FC	<input type="checkbox"/> <input type="checkbox"/> <input type="checkbox"/> <input type="checkbox"/>	<input type="checkbox"/> <input type="checkbox"/> <input type="checkbox"/> <input type="checkbox"/>	<input type="checkbox"/> <input type="checkbox"/>	<input type="checkbox"/> <input type="checkbox"/>	<input type="checkbox"/> <input type="checkbox"/>	<input type="checkbox"/> <input type="checkbox"/>	<input type="checkbox"/> <input type="checkbox"/>	95.00#	\$ 2852	\$ 272
	Left Chair Connector	SPMACCLC/FC	<input type="checkbox"/> <input type="checkbox"/> <input type="checkbox"/> <input type="checkbox"/>	<input type="checkbox"/> <input type="checkbox"/> <input type="checkbox"/> <input type="checkbox"/>	<input type="checkbox"/> <input type="checkbox"/>	<input type="checkbox"/> <input type="checkbox"/>	<input type="checkbox"/> <input type="checkbox"/>	<input type="checkbox"/> <input type="checkbox"/>	<input type="checkbox"/> <input type="checkbox"/>	95.00#	2852	272
SMAMC												

**A** **B** **C** **D** **E** **F** **G** **H**

**HOW TO ORDER**

- Indicate the following information on order form:
- Quantity of each item.
  - Model number, including options. See "How To Build a Model Number".
  - Any special service required.

Note: • The  indicates that a choice is required.  
• The absence of the  indicates that no choice is required.  
• Alpha-numeric characters in place of  indicate that no other alternatives are available.

**HOW TO BUILD A MODEL NUMBER**

- A** Select basic model.
- B** Select non-contrast or fabric contrast 1. Refer to [ki.com/fabrics](http://ki.com/fabrics).
  - For yardage pricing, see Fabric Yardage Pricing page
- C** Select fabric contrast 2. Refer to [ki.com/fabrics](http://ki.com/fabrics).
  - For yardage pricing, see Fabric Yardage Pricing page
- D** Select base finish color. Refer to the **Product Color Options** page in this price list.
- E** Select armcaps.
  - PACBL** - Black poly armcap; add \$94
  - PACSA** - Sand poly; add \$94
  - PACWG** - Warm Grey poly; add \$94
  - WAC** - Wood armcaps (pair)
  - SAC** - Solid surface armcaps; add \$706 Upcharge for two armcaps.
- F** Select wood finish color. Refer to the **Product Color Options** page in this price list. Wood finish selection is for wood armcaps. For Kensington Maple add upcharge.
- G** Select nylon glide color.
  - NGFN** - Flannel (Dark Grey)
  - NGNT** - Natural (Cream)
- H** Select moisture barrier.
  - MB** - Moisture barrier
  - NMB** - No moisture barrier
 See pricing column for moisture barrier upcharge.

Solid surface armcap color is always Corian™ white.

**KENSINGTON MAPLE UPCHARGE**

Kensington Maple requires extended leadtimes. Model  
All variations of Two Seat Add-on Models:

SOMACCL	\$63
SOMACCR	\$63
SPMACCL	\$63
SPMACCR	\$63

**SPECIAL SERVICES**

**Special Carton Marking**  
With specially marked information N/C

**Shipping**  
Ships **assembled, FOB High Point, NC 27263, freight prepaid.** Freight class 175

Specifications and prices are subject to change without prior notice.

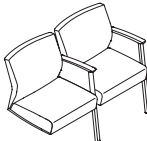
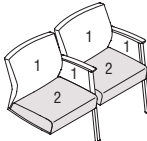

MODEL	Features	MODEL NUMBER								Approx. Packaged Weight	Delivered Pricing	Moisture Barrier add to list price
		Basic Model	Non-Contrast or Fabric Contrast 1	Fabric Contrast 2	Base Finish	Arm Cap	Wood Finish	Glide Color	Moist. Barrier			
 Two Seat Add-on Unit - Right Facing (Closed Arm) Non-Contrast • Non-contrast C.O.M = 4.25 yd	No Connector	SPMACCR/NC	<input type="checkbox"/> <input type="checkbox"/> <input type="checkbox"/> <input type="checkbox"/>		<input type="checkbox"/> <input type="checkbox"/>	<input type="checkbox"/> <input type="checkbox"/>	<input type="checkbox"/> <input type="checkbox"/>	<input type="checkbox"/> <input type="checkbox"/>	<input type="checkbox"/> <input type="checkbox"/>	95.00#	\$ 2743	\$ 272
	Right Chair Connector	SPMACCR/NC	<input type="checkbox"/> <input type="checkbox"/> <input type="checkbox"/> <input type="checkbox"/>		<input type="checkbox"/> <input type="checkbox"/>	<input type="checkbox"/> <input type="checkbox"/>	<input type="checkbox"/> <input type="checkbox"/>	<input type="checkbox"/> <input type="checkbox"/>	<input type="checkbox"/> <input type="checkbox"/>	<input type="checkbox"/> <input type="checkbox"/>	95.00#	2743
SMAMC												
 Two Seat Add-on Unit - Right Facing (Closed Arm) Contrast • 1 = Back and arms (Fabric Contrast 1) C.O.M. = 3.25 yd • 2 = Seat (Fabric Contrast 2) C.O.M. = 1.5 yd	No Connector	SPMACCR/FC	<input type="checkbox"/> <input type="checkbox"/> <input type="checkbox"/> <input type="checkbox"/>	<input type="checkbox"/> <input type="checkbox"/> <input type="checkbox"/> <input type="checkbox"/>	<input type="checkbox"/> <input type="checkbox"/>	<input type="checkbox"/> <input type="checkbox"/>	<input type="checkbox"/> <input type="checkbox"/>	<input type="checkbox"/> <input type="checkbox"/>	<input type="checkbox"/> <input type="checkbox"/>	95.00#	\$ 2852	\$ 272
	Right Chair Connector	SPMACCR/FC	<input type="checkbox"/> <input type="checkbox"/> <input type="checkbox"/> <input type="checkbox"/>	<input type="checkbox"/> <input type="checkbox"/> <input type="checkbox"/> <input type="checkbox"/>	<input type="checkbox"/> <input type="checkbox"/>	<input type="checkbox"/> <input type="checkbox"/>	<input type="checkbox"/> <input type="checkbox"/>	<input type="checkbox"/> <input type="checkbox"/>	<input type="checkbox"/> <input type="checkbox"/>	<input type="checkbox"/> <input type="checkbox"/>	95.00#	2852
SMAMC												
			<b>A</b>	<b>B</b>	<b>C</b>	<b>D</b>	<b>E</b>	<b>F</b>	<b>G</b>	<b>H</b>		

**HOW TO ORDER**

- Indicate the following information on order form:
- Quantity of each item.
  - Model number, including options. See "How To Build a Model Number".
  - Any special service required.

Note: • The  indicates that a choice is required.  
 • The absence of the  indicates that no choice is required.  
 • Alpha-numeric characters in place of  indicate that no other alternatives are available.

**HOW TO BUILD A MODEL NUMBER**

- A** Select basic model.
- B** Select non-contrast or fabric contrast 1. Refer to [ki.com/fabrics](http://ki.com/fabrics).
  - For yardage pricing, see Fabric Yardage Pricing page
- C** Select fabric contrast 2. Refer to [ki.com/fabrics](http://ki.com/fabrics).
  - For yardage pricing, see Fabric Yardage Pricing page
- D** Select base finish color. Refer to the **Product Color Options** page in this price list.
- E** Select armcaps.
  - PACBL** - Black poly armcap; add \$94
  - PACSA** - Sand poly; add \$94
  - PACWG** - Warm Grey poly; add \$94
  - WAC** - Wood armcaps (pair)
  - SAC** - Solid surface armcaps; add \$706 Upcharge for two armcaps.

Solid surface armcap color is always Corian™ white.

- F** Select wood finish color. Refer to the **Product Color Options** page in this price list. Wood finish selection is for wood armcaps. For Kensington Maple add upcharge.
- G** Select nylon glide color.
  - NGFN** - Flannel (Dark Grey)
  - NGNT** - Natural (Cream)
- H** Select moisture barrier.
  - MB** - Moisture barrier
  - NMB** - No moisture barrier
 See pricing column for moisture barrier upcharge.

**KENSINGTON MAPLE UPCHARGE**

Kensington Maple requires extended leadtimes. Model  
 All variations of Two Seat Add-on Models:

SOMACCL	\$63
SOMACCR	\$63
SPMACCL	\$63
SPMACCR	\$63

**SPECIAL SERVICES**

**Special Carton Marking**

With specially marked information N/C

**Shipping**  
 Ships assembled, FOB High Point, NC 27263, freight prepaid. Freight class 175

Specifications and prices are subject to change without prior notice.

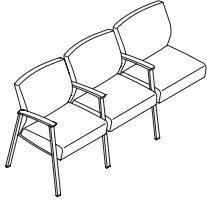
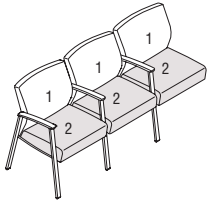

MODEL	Features	MODEL NUMBER								Approx. Packaged Weight	Delivered Pricing	Moisture Barrier add to list price
		Basic Model	Non-Contrast or Fabric Contrast 1	Fabric Contrast 2	Base Finish	Arm Cap	Wood Finish	Glide Color	Moist. Barrier			
 <p><b>Three Seat Add-on Unit - Left Facing (Open Arm) Non-Contrast</b> • Non-contrast C.O.M = 4.5 yd</p>	No Connector	SOMACCCL/NC	<input type="checkbox"/> <input type="checkbox"/> <input type="checkbox"/> <input type="checkbox"/>		<input type="checkbox"/> <input type="checkbox"/>	<input type="checkbox"/> <input type="checkbox"/>	<input type="checkbox"/> <input type="checkbox"/>	<input type="checkbox"/> <input type="checkbox"/>	<input type="checkbox"/> <input type="checkbox"/>	120.00#	\$ 3571	\$ 280
	Left Chair Connector	SOMACCCL/NC	<input type="checkbox"/> <input type="checkbox"/> <input type="checkbox"/> <input type="checkbox"/>		<input type="checkbox"/> <input type="checkbox"/>	<input type="checkbox"/> <input type="checkbox"/>	<input type="checkbox"/> <input type="checkbox"/>	<input type="checkbox"/> <input type="checkbox"/>	<input type="checkbox"/> <input type="checkbox"/>	120.00#	3571	280
SMAMC												
 <p><b>Three Seat Add-on Unit - Left Facing (Open Arm) Contrast</b> • 1 = Back (Fabric Contrast 1) C.O.M. = 3 yd • 2 = Seat (Fabric Contrast 2) C.O.M. = 2.25 yd</p>	No Connector	SOMACCCL/FC	<input type="checkbox"/> <input type="checkbox"/> <input type="checkbox"/> <input type="checkbox"/>	<input type="checkbox"/> <input type="checkbox"/> <input type="checkbox"/> <input type="checkbox"/>	<input type="checkbox"/> <input type="checkbox"/>	<input type="checkbox"/> <input type="checkbox"/>	<input type="checkbox"/> <input type="checkbox"/>	<input type="checkbox"/> <input type="checkbox"/>	<input type="checkbox"/> <input type="checkbox"/>	120.00#	\$ 3725	\$ 280
	Left Chair Connector	SOMACCCL/FC	<input type="checkbox"/> <input type="checkbox"/> <input type="checkbox"/> <input type="checkbox"/>	<input type="checkbox"/> <input type="checkbox"/> <input type="checkbox"/> <input type="checkbox"/>	<input type="checkbox"/> <input type="checkbox"/>	<input type="checkbox"/> <input type="checkbox"/>	<input type="checkbox"/> <input type="checkbox"/>	<input type="checkbox"/> <input type="checkbox"/>	<input type="checkbox"/> <input type="checkbox"/>	120.00#	3725	280
SMAMC												
			<b>A</b>	<b>B</b>	<b>C</b>	<b>D</b>	<b>E</b>	<b>F</b>	<b>G</b>	<b>H</b>		

**HOW TO ORDER**

- Indicate the following information on order form:
- Quantity of each item.
  - Model number, including options. See "How To Build a Model Number".
  - Any special service required.

Note: • The  indicates that a choice is required.  
• The absence of the  indicates that no choice is required.  
• Alpha-numeric characters in place of  indicate that no other alternatives are available.

**HOW TO BUILD A MODEL NUMBER**

- A** Select basic model.
- B** Select non-contrast or fabric contrast 1. Refer to [ki.com/fabrics](http://ki.com/fabrics).  
• For yardage pricing, see Fabric Yardage Pricing page
- C** Select fabric contrast 2. Refer to [ki.com/fabrics](http://ki.com/fabrics).  
• For yardage pricing, see Fabric Yardage Pricing page
- D** Select base finish color. Refer to the **Product Color Options** page in this price list.
- E** Select armcaps.  
**PACBL** - Black poly armcap; add \$141  
**PACSA** - Sand poly; add \$141  
**PACWG** - Warm Grey poly; add \$141  
**WAC** - Wood armcaps (pair)  
**SAC** - Solid surface armcaps; add \$1017  
Upcharge for three armcaps.

Solid surface armcap color is always Corian™ white.

- F** Select wood finish color. Refer to the **Product Color Options** page in this price list. Wood finish selection is for wood armcaps. For Kensington Maple add upcharge.
- G** Select nylon glide color.  
**NGFN** - Flannel (Dark Grey)  
**NGNT** - Natural (Cream)
- H** Select moisture barrier.  
**MB** - Moisture barrier  
**NMB** - No moisture barrier  
See pricing column for moisture barrier upcharge.

**KENSINGTON MAPLE UPCHARGE**

Kensington Maple requires extended leadtimes. Model  
All variations of Three Seat Add-on Models:  
SOMACCCL \$94  
SOMACCCR \$94  
SPMACCCL \$94  
SPMACCCR \$94

**SPECIAL SERVICES**

**Special Carton Marking**

With specially marked information N/C

**Shipping**  
Ships **assembled, FOB High Point, NC 27263, freight prepaid.** Freight class 175

Specifications and prices are subject to change without prior notice.

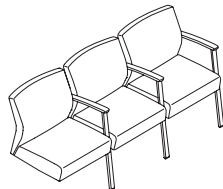
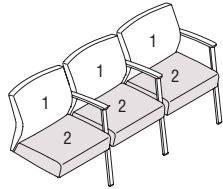

Features	MODEL NUMBER								Approx. Packaged Weight	Delivered Pricing	Moisture Barrier add to list price	
	Basic Model	Non-Contrast or Fabric Contrast 1	Fabric Contrast 2	Base Finish	Arm Cap	Wood Finish	Glide Color	Moist. Barrier				
 <p>SMAMC <b>Three Seat Add-on Unit - Right Facing (Open Arm) Non-Contrast</b></p> <ul style="list-style-type: none"> <li>• Non-contrast C.O.M = 4.5 yd</li> </ul>	No Connector	SOMACCCR/NC	<input type="checkbox"/> <input type="checkbox"/> <input type="checkbox"/> <input type="checkbox"/>		<input type="checkbox"/> <input type="checkbox"/>	<input type="checkbox"/> <input type="checkbox"/>	<input type="checkbox"/> <input type="checkbox"/>	<input type="checkbox"/> <input type="checkbox"/>	120.00#	\$ 3571	\$ 280	
	Right Chair Connector	SOMACCCRC/NC	<input type="checkbox"/> <input type="checkbox"/> <input type="checkbox"/> <input type="checkbox"/>		<input type="checkbox"/> <input type="checkbox"/>	<input type="checkbox"/> <input type="checkbox"/>	<input type="checkbox"/> <input type="checkbox"/>	<input type="checkbox"/> <input type="checkbox"/>	<input type="checkbox"/> <input type="checkbox"/>	120.00#	3571	280
 <p>SMAMC <b>Three Seat Add-on Unit - Right Facing (Open Arm) Contrast</b></p> <ul style="list-style-type: none"> <li>• 1 = Back (Fabric Contrast 1) C.O.M. = 3 yd</li> <li>• 2 = Seat (Fabric Contrast 2) C.O.M. = 2.25 yd</li> </ul>	No Connector	SOMACCCR/FC	<input type="checkbox"/> <input type="checkbox"/> <input type="checkbox"/> <input type="checkbox"/>	<input type="checkbox"/> <input type="checkbox"/> <input type="checkbox"/> <input type="checkbox"/>	<input type="checkbox"/> <input type="checkbox"/>	<input type="checkbox"/> <input type="checkbox"/>	<input type="checkbox"/> <input type="checkbox"/>	<input type="checkbox"/> <input type="checkbox"/>	120.00#	\$ 3725	\$ 280	
	Right Chair Connector	SOMACCCRC/FC	<input type="checkbox"/> <input type="checkbox"/> <input type="checkbox"/> <input type="checkbox"/>	<input type="checkbox"/> <input type="checkbox"/> <input type="checkbox"/> <input type="checkbox"/>	<input type="checkbox"/> <input type="checkbox"/>	<input type="checkbox"/> <input type="checkbox"/>	<input type="checkbox"/> <input type="checkbox"/>	<input type="checkbox"/> <input type="checkbox"/>	<input type="checkbox"/> <input type="checkbox"/>	120.00#	3725	280
			<b>A</b>	<b>B</b>	<b>C</b>	<b>D</b>	<b>E</b>	<b>F</b>	<b>G</b>	<b>H</b>		

**HOW TO ORDER**

- Indicate the following information on order form:
1. Quantity of each item.
  2. Model number, including options. See "How To Build a Model Number".
  3. Any special service required.

Note: • The  indicates that a choice is required.  
 • The absence of the  indicates that no choice is required.  
 • Alpha-numeric characters in place of  indicate that no other alternatives are available.

**HOW TO BUILD A MODEL NUMBER**

- A** Select basic model.
- B** Select non-contrast or fabric contrast 1. Refer to [ki.com/fabrics](http://ki.com/fabrics).
  - For yardage pricing, see Fabric Yardage Pricing page
- C** Select fabric contrast 2. Refer to [ki.com/fabrics](http://ki.com/fabrics).
  - For yardage pricing, see Fabric Yardage Pricing page
- D** Select base finish color. Refer to the **Product Color Options** page in this price list.
- E** Select armcaps.
  - PACBL** - Black poly armcap; add \$141
  - PACSA** - Sand poly; add \$141
  - PACWG** - Warm Grey poly; add \$141
  - WAC** - Wood armcaps (pair)
  - SAC** - Solid surface armcaps; add \$1017 Upcharge for three armcaps.

Solid surface armcap color is always Corian™ white.

- F** Select wood finish color. Refer to the **Product Color Options** page in this price list. Wood finish selection is for wood armcaps. For Kensington Maple add upcharge.
- G** Select nylon glide color.
  - NGFN** - Flannel (Dark Grey)
  - NGNT** - Natural (Cream)
- H** Select moisture barrier.
  - MB** - Moisture barrier
  - NMB** - No moisture barrier
 See pricing column for moisture barrier upcharge.

**KENSINGTON MAPLE UPCHARGE**

Kensington Maple requires extended leadtimes. Model  
 All variations of Three Seat Add-on Models:

SOMACCCL	\$94
SOMACCCR	\$94
SPMACCCL	\$94
SPMACCCR	\$94

**SPECIAL SERVICES**

**Special Carton Marking**

With specially marked information N/C

**Shipping**  
 Ships assembled, FOB High Point, NC 27263, freight prepaid. Freight class 175

Specifications and prices are subject to change without prior notice.

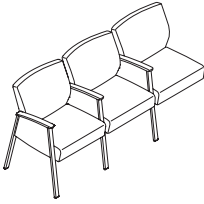
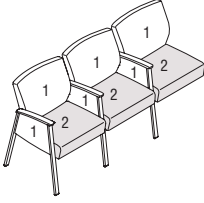

MODEL	Features	MODEL NUMBER								Approx. Packaged Weight	Delivered Pricing	Moisture Barrier add to list price
		Basic Model	Non-Contrast or Fabric Contrast 1	Fabric Contrast 2	Base Finish	Arm Cap	Wood Finish	Glide Color	Moist. Barrier			
 <p><b>Three Seat Add-on Unit-Left Facing (Closed Arm) Non-Contrast</b> • Non-contrast C.O.M = 6.25 yd</p>	No Connector	SPMACCCL/NC	<input type="checkbox"/> <input type="checkbox"/> <input type="checkbox"/> <input type="checkbox"/>		<input type="checkbox"/> <input type="checkbox"/>	<input type="checkbox"/> <input type="checkbox"/>	<input type="checkbox"/> <input type="checkbox"/>	<input type="checkbox"/> <input type="checkbox"/>	<input type="checkbox"/> <input type="checkbox"/>	125.00#	\$ 3941	\$ 300
	Left Chair Connector	SPMACCCL/NC	<input type="checkbox"/> <input type="checkbox"/> <input type="checkbox"/> <input type="checkbox"/>		<input type="checkbox"/> <input type="checkbox"/>	<input type="checkbox"/> <input type="checkbox"/>	<input type="checkbox"/> <input type="checkbox"/>	<input type="checkbox"/> <input type="checkbox"/>	<input type="checkbox"/> <input type="checkbox"/>	125.00#	3941	300
SMAMC												
 <p><b>Three Seat Add-on Unit-Left Facing (Closed Arm) Contrast</b> • 1 = Back and arms (Fabric Contrast 1) C.O.M. = 4.75 yd • 2 = Seat (Fabric Contrast 2) C.O.M. = 2.25 yd</p>	No Connector	SPMACCCL/FC	<input type="checkbox"/> <input type="checkbox"/> <input type="checkbox"/> <input type="checkbox"/>	<input type="checkbox"/> <input type="checkbox"/> <input type="checkbox"/> <input type="checkbox"/>	<input type="checkbox"/> <input type="checkbox"/>	<input type="checkbox"/> <input type="checkbox"/>	<input type="checkbox"/> <input type="checkbox"/>	<input type="checkbox"/> <input type="checkbox"/>	<input type="checkbox"/> <input type="checkbox"/>	125.00#	\$ 4101	\$ 300
	Left Chair Connector	SPMACCCL/FC	<input type="checkbox"/> <input type="checkbox"/> <input type="checkbox"/> <input type="checkbox"/>	<input type="checkbox"/> <input type="checkbox"/> <input type="checkbox"/> <input type="checkbox"/>	<input type="checkbox"/> <input type="checkbox"/>	<input type="checkbox"/> <input type="checkbox"/>	<input type="checkbox"/> <input type="checkbox"/>	<input type="checkbox"/> <input type="checkbox"/>	<input type="checkbox"/> <input type="checkbox"/>	125.00#	4101	300
SMAMC												
			<b>A</b>	<b>B</b>	<b>C</b>	<b>D</b>	<b>E</b>	<b>F</b>	<b>G</b>	<b>H</b>		

**HOW TO ORDER**

- Indicate the following information on order form:
- Quantity of each item.
  - Model number, including options. See "How To Build a Model Number".
  - Any special service required.

Note: • The  indicates that a choice is required.  
• The absence of the  indicates that no choice is required.  
• Alpha-numeric characters in place of  indicate that no other alternatives are available.

**HOW TO BUILD A MODEL NUMBER**

- A** Select basic model.
- B** Select non-contrast or fabric contrast 1. Refer to [ki.com/fabrics](http://ki.com/fabrics).  
• For yardage pricing, see Fabric Yardage Pricing page
- C** Select fabric contrast 2. Refer to [ki.com/fabrics](http://ki.com/fabrics).  
• For yardage pricing, see Fabric Yardage Pricing page
- D** Select base finish color. Refer to the **Product Color Options** page in this price list.
- E** Select armcaps.
  - PACBL** - Black poly armcap; add \$141
  - PACSA** - Sand poly; add \$141
  - PACWG** - Warm Grey poly; add \$141
  - WAC** - Wood armcaps (pair)
  - SAC** - Solid surface armcaps; add \$1017 Upcharge for three armcaps.

Solid surface armcap color is always Corian™ white.

- F** Select wood finish color. Refer to the **Product Color Options** page in this price list. Wood finish selection is for wood armcaps. For Kensington Maple add upcharge.
- G** Select nylon glide color.
  - NGFN** - Flannel (Dark Grey)
  - NGNT** - Natural (Cream)
- H** Select moisture barrier.
  - MB** - Moisture barrier
  - NMB** - No moisture barrier
 See pricing column for moisture barrier upcharge.

**KENSINGTON MAPLE UPCHARGE**

Kensington Maple requires extended leadtimes. Model  
All variations of Three Seat Add-on Models:

SOMACCCL	\$94
SOMACCCR	\$94
SPMACCCL	\$94
SPMACCCR	\$94

**SPECIAL SERVICES**

**Special Carton Marking**

With specially marked information N/C

**Shipping**  
Ships **assembled, FOB High Point, NC 27263, freight prepaid.** Freight class 175

Specifications and prices are subject to change without prior notice.

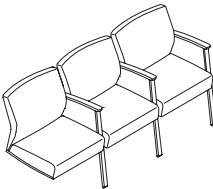
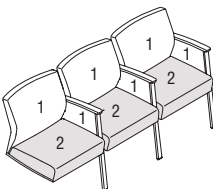

Features	MODEL NUMBER								Approx. Packaged Weight	Delivered Pricing	Moisture Barrier add to list price
	Basic Model	Non-Contrast or Fabric Contrast 1	Fabric Contrast 2	Base Finish	Arm Cap	Wood Finish	Glide Color	Moist. Barrier			
 SMAMC <b>Three Seat Add-on Unit-Right Facing (Closed Arm) Non-Contrast</b> • Non-contrast C.O.M = 6.25 yd	No Connector	SPMACCCR/NC	<input type="checkbox"/> <input type="checkbox"/> <input type="checkbox"/> <input type="checkbox"/>	<input type="checkbox"/>	<input type="checkbox"/>	<input type="checkbox"/>	<input type="checkbox"/>	<input type="checkbox"/>	125.00#	\$ 3941	\$ 300
	Right Chair Connector	SPMACCCRC/NC	<input type="checkbox"/> <input type="checkbox"/> <input type="checkbox"/> <input type="checkbox"/>	<input type="checkbox"/>	<input type="checkbox"/>	<input type="checkbox"/>	<input type="checkbox"/>	<input type="checkbox"/>	<input type="checkbox"/>	125.00#	3941
 SMAMC <b>Three Seat Add-on Unit-Right Facing (Closed Arm) Contrast</b> • 1 = Back and arms (Fabric Contrast 1) C.O.M. = 4.75 yd • 2 = Seat (Fabric Contrast 2) C.O.M. = 2.25 yd	No Connector	SPMACCCR/FC	<input type="checkbox"/> <input type="checkbox"/> <input type="checkbox"/> <input type="checkbox"/>	<input type="checkbox"/> <input type="checkbox"/> <input type="checkbox"/> <input type="checkbox"/>	<input type="checkbox"/>	<input type="checkbox"/>	<input type="checkbox"/>	<input type="checkbox"/>	125.00#	\$ 4101	\$ 300
	Right Chair Connector	SPMACCCRC/FC	<input type="checkbox"/> <input type="checkbox"/> <input type="checkbox"/> <input type="checkbox"/>	<input type="checkbox"/> <input type="checkbox"/> <input type="checkbox"/> <input type="checkbox"/>	<input type="checkbox"/>	<input type="checkbox"/>	<input type="checkbox"/>	<input type="checkbox"/>	<input type="checkbox"/>	125.00#	4101
			<b>A</b>	<b>B</b>	<b>C</b>	<b>D</b>	<b>E</b>	<b>F</b>	<b>G</b>		<b>H</b>

**HOW TO ORDER**

Indicate the following information on order form:  
 1. Quantity of each item.  
 2. Model number, including options. See "How To Build a Model Number".  
 3. Any special service required.

Note: • The  indicates that a choice is required.  
 • The absence of the  indicates that no choice is required.  
 • Alpha-numeric characters in place of  indicate that no other alternatives are available.

**HOW TO BUILD A MODEL NUMBER**

- A** Select basic model.
- B** Select non-contrast or fabric contrast 1. Refer to [ki.com/fabrics](http://ki.com/fabrics).  
 • For yardage pricing, see Fabric Yardage Pricing page
- C** Select fabric contrast 2. Refer to [ki.com/fabrics](http://ki.com/fabrics).  
 • For yardage pricing, see Fabric Yardage Pricing page
- D** Select base finish color. Refer to the **Product Color Options** page in this price list.
- E** Select armcaps.  
 PACBL - Black poly armcap; add \$141  
 PACSA - Sand poly; add \$141  
 PACWG - Warm Grey poly; add \$141  
 WAC - Wood armcaps (pair)  
 SAC - Solid surface armcaps; add \$1017  
 Upcharge for three armcaps.

Solid surface armcap color is always Corian™ white.

- F** Select wood finish color. Refer to the **Product Color Options** page in this price list.  
 Wood finish selection is for wood armcaps. For Kensington Maple add upcharge.
- G** Select nylon glide color.  
 NGFN - Flannel (Dark Grey)  
 NGNT - Natural (Cream)
- H** Select moisture barrier.  
 MB - Moisture barrier  
 NMB - No moisture barrier  
 See pricing column for moisture barrier upcharge.

**KENSINGTON MAPLE UPCHARGE**

Kensington Maple requires extended leadtimes.  
 Model  
 All variations of Three Seat Add-on Models:  
 SOMACCCL \$94  
 SOMACCCR \$94  
 SPMACCCL \$94  
 SPMACCCR \$94

**SPECIAL SERVICES**

**Special Carton Marking**  
 With specially marked information N/C

**Shipping**  
 Ships assembled, FOB High Point, NC 27263, freight prepaid. Freight class 175

Specifications and prices are subject to change without prior notice.



	Open Arm Lounge (SLOM23)	Open Arm Loveseat (SLOM33)	Open Arm Sofa (SLOM43)	Closed Arm Lounge (SLPM23)	Closed Arm Loveseat (SLPM33)	Closed Arm Sofa (SLPM43)
<b>General Dimensions</b>						
Seat width	22"	44"	66"	22"	44"	66"
Seat depth	19"	19"	19"	19"	19"	19"
Seat height	19"	19"	19"	19"	19"	19"
Arm width	2-1/4"	2-1/4"	2-1/4"	2-1/4"	2-1/4"	2-1/4"
Arm height	27"	27"	27"	27"	27"	27"
<b>Overall Dimensions</b>						
Width	26-1/2"	48-1/2"	70-1/2"	26-1/2"	48-1/2"	70-1/2"
Depth	29"	29"	29"	29"	29"	29"
Height	33-1/2"	33-1/2"	33-1/2"	33-1/2"	33-1/2"	33-1/2"

	Ottoman (SM20)
<b>General Dimensions</b>	
Seat width	
Seat depth	
Seat height	
Arm width	
Arm height	
<b>Overall Dimensions</b>	
Width	22-1/2"
Depth	22"
Height	18"

#### UPHOLSTERY INFORMATION

##### C. O. M. Fabric

For C.O.M. fabric sent to KI-High Point on multiple rolls, add an additional yard of fabric per roll to the yardage requirements. Multiple rolls have shorter pieces of fabric on them and do not allow nesting and stacking of the fabric to achieve the best yield as is done with one large roll. This results in yardage shortages and requests for additional fabric from the client, which can delay an order. For each roll that is sent, one yard needs to be added to one of the rolls, not separately.

##### Fabric Disclaimer

Fabric will be applied as swatched by the fabric manufacturer. Fabric that is required to be applied differently than is swatched will need a Product Modification Request written specifying the direction the fabric is to be applied.

#### FINISH INFORMATION

##### Color Match

KI offers the additional option of color matching paint, polypropylene, or wood stain through Product Modification Requests. Contact Customer Service for details.

#### INFORMATION

##### Warranty

Refer to KI Terms & Conditions document or visit [ki.com](http://ki.com)



### Lounge Seating (Open Arm/ Closed Arm)

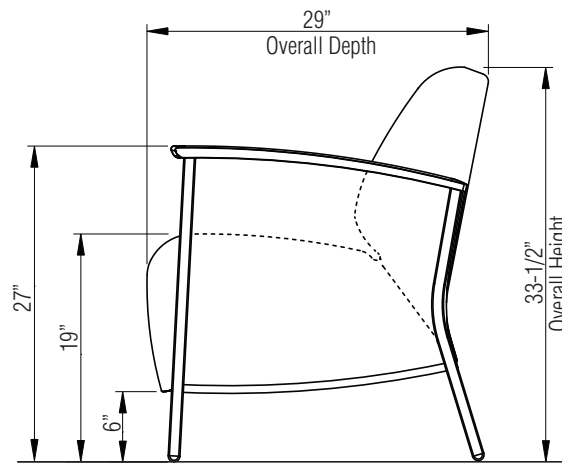

Lounge Seating - All Models

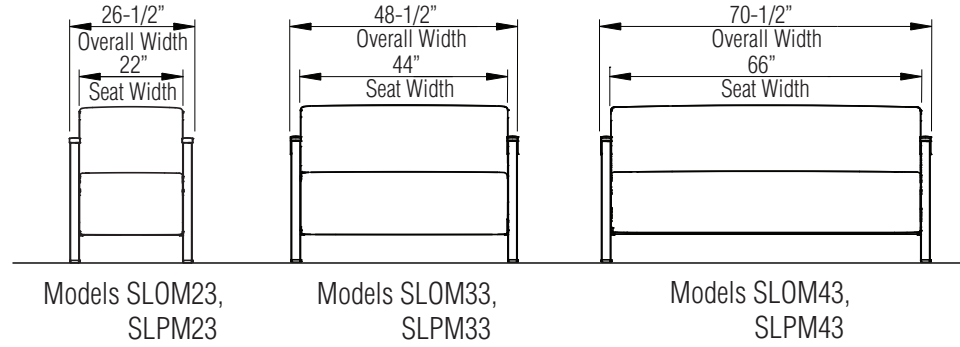

### Lounge Seating - Ottoman

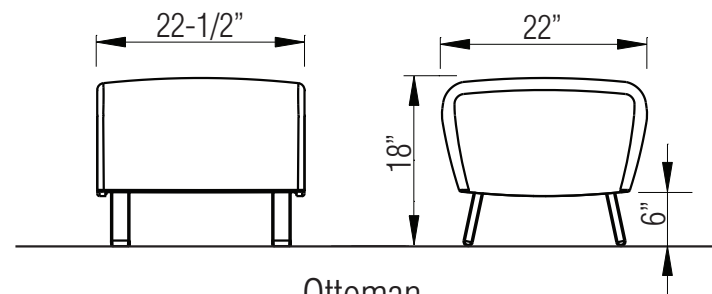

Ottoman  
Model SM20



## Base Finish

Black	BL
Blue Grey	GR
Bronze Metallic	ZM
Cayenne	CY
Champagne Metallic	CM
Cool Grey	CG
Cottonwood	CO
Earthen Clay	EY
Espresso Metallic	EX
Everglade Shade	EV
Flannel	FN
Glitz Metallic	GZ
Hazy Jade	HJ
Honey Bee	HY
Light Tone	LG
Mardi Gras	MG
Misty Brown	MY
Nemo	NE
Nordic	ND
Poppy Red	PR
Purple Haze	PH
Rainforest	RQ
Raw Jasper	RJ
Rubber Ducky	RK
Sand	SA
Sky Blue	SK
Starlight Silver Metallic	SX
Surf's Up	SP
Tarragon	TQ
Twilight Shadow	TI
Ultra Blue	UB
Warm Grey	WG
Zesty Lime	ZL

## Wood Armcap Finish

Cherry Storm on Beech	BCX
Cinnamon on Beech	BCN
Cocoa on Beech	BCA
Eclipse Black on Beech	BEB
Florence Walnut on Beech	BFC
Kensington Maple on Maple	MMA
Monticello Maple on Beech	BMT
Natural on Beech	BNA
River Cherry on Beech	BRY

Kensington Maple requires an upcharge.

## Glide Color

Flannel (Dark Grey)	NGFN
Natural (Cream)	NGNT

## Finish Cards

View color swatches for items listed within this document.

[Paints](#)

[Plastics/Poly](#)

[Wood/Veneer](#)

[Laminates](#)

[Molded Edges](#)

[Edge Styles](#)

[Hard Plastics](#)

[Glass](#)

Certain options referenced may not be available on GSA Schedule.

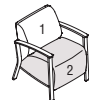
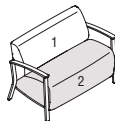
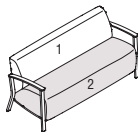

MODEL	Features	MODEL NUMBER								Approx. Packaged Weight	Delivered Pricing	Moisture Barrier add to list price
		Basic Model	Non-Contrast or Fabric Contrast 1	Fabric Contrast 2	Base Finish	Arm Cap	Wood Finish	Glide Color	Moisture Barrier			
 SMLS <b>Lounge Chair (Open Arm)</b> • Non-contrast C.O.M = 3 yd • 1 = Back (Fabric Contrast 1) C.O.M. = 1.75 yd • 2 = Seat (Fabric Contrast 2) C.O.M. = 1.5 yd • W=26-1/2" D=29" H=33-1/2"	Non-contrast	SLOM23/NC	<input type="checkbox"/> <input type="checkbox"/> <input type="checkbox"/> <input type="checkbox"/>		<input type="checkbox"/> <input type="checkbox"/>	<input type="checkbox"/> <input type="checkbox"/>	<input type="checkbox"/> <input type="checkbox"/> <input type="checkbox"/> <input type="checkbox"/>	<input type="checkbox"/> <input type="checkbox"/>	<input type="checkbox"/> <input type="checkbox"/>	65.00#	\$ 2376	\$ 265
	Contrast	SLOM23/FC	<input type="checkbox"/> <input type="checkbox"/> <input type="checkbox"/> <input type="checkbox"/>	<input type="checkbox"/> <input type="checkbox"/> <input type="checkbox"/> <input type="checkbox"/>	<input type="checkbox"/> <input type="checkbox"/>	<input type="checkbox"/> <input type="checkbox"/>	<input type="checkbox"/> <input type="checkbox"/> <input type="checkbox"/> <input type="checkbox"/>	<input type="checkbox"/> <input type="checkbox"/>	<input type="checkbox"/> <input type="checkbox"/>	65.00#	2456	265
 SMLS <b>Loveseat (Open Arm)</b> • Non-contrast C.O.M = 4.5 yd • 1 = Back (Fabric Contrast 1) C.O.M. = 3 yd • 2 = Seat (Fabric Contrast 2) C.O.M. = 2.5 yd • W=48-1/2" D=29" H=33-1/2"	Non-contrast	SLOM33/NC	<input type="checkbox"/> <input type="checkbox"/> <input type="checkbox"/> <input type="checkbox"/>		<input type="checkbox"/> <input type="checkbox"/>	<input type="checkbox"/> <input type="checkbox"/>	<input type="checkbox"/> <input type="checkbox"/> <input type="checkbox"/> <input type="checkbox"/>	<input type="checkbox"/> <input type="checkbox"/>	<input type="checkbox"/> <input type="checkbox"/>	110.00#	\$ 3134	\$ 311
	Contrast	SLOM33/FC	<input type="checkbox"/> <input type="checkbox"/> <input type="checkbox"/> <input type="checkbox"/>	<input type="checkbox"/> <input type="checkbox"/> <input type="checkbox"/> <input type="checkbox"/>	<input type="checkbox"/> <input type="checkbox"/>	<input type="checkbox"/> <input type="checkbox"/>	<input type="checkbox"/> <input type="checkbox"/> <input type="checkbox"/> <input type="checkbox"/>	<input type="checkbox"/> <input type="checkbox"/>	<input type="checkbox"/> <input type="checkbox"/>	110.00#	3253	311
 SMLS <b>Sofa (Open Arm)</b> • Non-contrast C.O.M = 6 yd • 1 = Back (Fabric Contrast 1) C.O.M. = 3.5 yd • 2 = Seat (Fabric Contrast 2) C.O.M. = 3 yd • W=70-1/2" D=29" H=33-1/2"	Non-contrast	SLOM43/NC	<input type="checkbox"/> <input type="checkbox"/> <input type="checkbox"/> <input type="checkbox"/>		<input type="checkbox"/> <input type="checkbox"/>	<input type="checkbox"/> <input type="checkbox"/>	<input type="checkbox"/> <input type="checkbox"/> <input type="checkbox"/> <input type="checkbox"/>	<input type="checkbox"/> <input type="checkbox"/>	<input type="checkbox"/> <input type="checkbox"/>	135.00#	\$ 3852	\$ 338
	Contrast	SLOM43/FC	<input type="checkbox"/> <input type="checkbox"/> <input type="checkbox"/> <input type="checkbox"/>	<input type="checkbox"/> <input type="checkbox"/> <input type="checkbox"/> <input type="checkbox"/>	<input type="checkbox"/> <input type="checkbox"/>	<input type="checkbox"/> <input type="checkbox"/>	<input type="checkbox"/> <input type="checkbox"/> <input type="checkbox"/> <input type="checkbox"/>	<input type="checkbox"/> <input type="checkbox"/>	<input type="checkbox"/> <input type="checkbox"/>	135.00#	4005	338

**A** **B** **C** **D** **E** **F** **G** **H**

**HOW TO ORDER**

- Indicate the following information on order form:
- Quantity of each item.
  - Model number, including options. See "How To Build a Model Number".
  - Any special service required.

Note:

- The  indicates that a choice is required.
- The absence of the  indicates that no choice is required.
- Alpha-numeric characters in place of  indicate that no other alternatives are available.

**HOW TO BUILD A MODEL NUMBER**

- A** Select basic model.
- B** Select non-contrast or fabric contrast 1. Refer to [ki.com/fabrics](http://ki.com/fabrics).
  - For yardage pricing, see Fabric Yardage Pricing page
- C** Select fabric contrast 2. Refer to [ki.com/fabrics](http://ki.com/fabrics).
  - For yardage pricing, see Fabric Yardage Pricing page
- D** Select base finish color. Refer to the **Product Color Options** page in this price list.
- E** Select armcap option.
  - WAC** - Wood armcaps (pair)
  - SAC** - Solid surface armcaps; add \$818
  - PACBL** - Black poly armcap; add \$134
  - PACSA** - Sand poly; add \$134
  - PACWG** - Warm Grey poly; add \$134
  - Solid surface armcap color is always Corian™

- white.
- F** Select wood finish color. Refer to the **Product Color Options** page in this price list. For Kensington Maple add upcharge.
- G** Select nylon glide color.
  - NGFN** - Flannel (Dark Grey)
  - NGNT** - Natural (Cream)
- H** Select moisture barrier.
  - MB** - Moisture barrier
  - NMB** - No moisture barrier
  - See pricing column for moisture barrier upcharge.

**KENSINGTON MAPLE UPCHARGE**

Kensington Maple requires extended leadtimes.

Model	Price
SLOM23	\$79
SLOM33	\$79
SLOM43	\$79
SLPM23	\$79
SLPM33	\$79
SLPM43	\$79

**SPECIAL SERVICES**

**Special Carton Marking**

With specially marked information N/C

**Shipping**  
Ships assembled, FOB High Point, NC 27263, freight prepaid. Freight class 175

Specifications and prices are subject to change without prior notice.

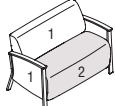
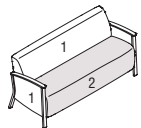

MODEL	Features	MODEL NUMBER								Approx. Packaged Weight	Delivered Pricing	Moisture Barrier add to list price
		Basic Model	Non-Contrast or Fabric Contrast 1	Fabric Contrast 2	Base Finish	Arm Cap	Wood Finish	Glide Color	Moisture Barrier			
 SMLS <b>Lounge Chair (Closed Arm)</b> • Non-contrast C.O.M = 4 yd • 1 = Back and arms (Fabric Contrast 1) C.O.M. = 3 yd • 2 = Seat (Fabric Contrast 2) C.O.M. = 1.5 yd • W=26-1/2" D=29" H=33-1/2"	Non-contrast	SLPM23/NC	<input type="checkbox"/> <input type="checkbox"/> <input type="checkbox"/> <input type="checkbox"/>		<input type="checkbox"/> <input type="checkbox"/>	<input type="checkbox"/> <input type="checkbox"/>	<input type="checkbox"/> <input type="checkbox"/> <input type="checkbox"/> <input type="checkbox"/>	<input type="checkbox"/> <input type="checkbox"/>	<input type="checkbox"/> <input type="checkbox"/>	85.00#	\$ 2945	\$ 288
	Contrast	SLPM23/FC	<input type="checkbox"/> <input type="checkbox"/> <input type="checkbox"/> <input type="checkbox"/>	<input type="checkbox"/> <input type="checkbox"/> <input type="checkbox"/> <input type="checkbox"/>	<input type="checkbox"/> <input type="checkbox"/>	<input type="checkbox"/> <input type="checkbox"/>	<input type="checkbox"/> <input type="checkbox"/> <input type="checkbox"/> <input type="checkbox"/>	<input type="checkbox"/> <input type="checkbox"/>	<input type="checkbox"/> <input type="checkbox"/>	85.00#	3031	288
 SMLS <b>Loveseat (Closed Arm)</b> • Non-contrast C.O.M = 5.75 yd • 1 = Back and arms (Fabric Contrast 1) C.O.M. = 4.25 yd • 2 = Seat (Fabric Contrast 2) C.O.M. = 2.25 yd • W=48-1/2" D=29" H=33-1/2"	Non-contrast	SLPM33/NC	<input type="checkbox"/> <input type="checkbox"/> <input type="checkbox"/> <input type="checkbox"/>		<input type="checkbox"/> <input type="checkbox"/>	<input type="checkbox"/> <input type="checkbox"/>	<input type="checkbox"/> <input type="checkbox"/> <input type="checkbox"/> <input type="checkbox"/>	<input type="checkbox"/> <input type="checkbox"/>	<input type="checkbox"/> <input type="checkbox"/>	110.00#	\$ 3584	\$ 330
	Contrast	SLPM33/FC	<input type="checkbox"/> <input type="checkbox"/> <input type="checkbox"/> <input type="checkbox"/>	<input type="checkbox"/> <input type="checkbox"/> <input type="checkbox"/> <input type="checkbox"/>	<input type="checkbox"/> <input type="checkbox"/>	<input type="checkbox"/> <input type="checkbox"/>	<input type="checkbox"/> <input type="checkbox"/> <input type="checkbox"/> <input type="checkbox"/>	<input type="checkbox"/> <input type="checkbox"/>	<input type="checkbox"/> <input type="checkbox"/>	110.00#	3710	330
 SMLS <b>Sofa (Closed Arm)</b> • Non-contrast C.O.M = 7.5 yd • 1 = Back and arms (Fabric Contrast 1) C.O.M. = 4.75 yd • 2 = Seat (Fabric Contrast 2) C.O.M. = 3 yd • W=70-1/2" D=29" H=33-1/2"	Non-contrast	SLPM43/NC	<input type="checkbox"/> <input type="checkbox"/> <input type="checkbox"/> <input type="checkbox"/>		<input type="checkbox"/> <input type="checkbox"/>	<input type="checkbox"/> <input type="checkbox"/>	<input type="checkbox"/> <input type="checkbox"/> <input type="checkbox"/> <input type="checkbox"/>	<input type="checkbox"/> <input type="checkbox"/>	<input type="checkbox"/> <input type="checkbox"/>	160.00#	\$ 4362	\$ 362
	Contrast	SLPM43/FC	<input type="checkbox"/> <input type="checkbox"/> <input type="checkbox"/> <input type="checkbox"/>	<input type="checkbox"/> <input type="checkbox"/> <input type="checkbox"/> <input type="checkbox"/>	<input type="checkbox"/> <input type="checkbox"/>	<input type="checkbox"/> <input type="checkbox"/>	<input type="checkbox"/> <input type="checkbox"/> <input type="checkbox"/> <input type="checkbox"/>	<input type="checkbox"/> <input type="checkbox"/>	<input type="checkbox"/> <input type="checkbox"/>	160.00#	4521	362

**A** **B** **C** **D** **E** **F** **G** **H**

**HOW TO ORDER**

- Indicate the following information on order form:
- Quantity of each item.
  - Model number, including options. See "How to Build a Model Number".
  - Any special service required.

Note:

- The  indicates that a choice is required.
- The absence of the  indicates that no choice is required.
- Alpha-numeric characters in place of  indicate that no other alternatives are available.

**HOW TO BUILD A MODEL NUMBER**

- A** Select basic model.
- B** Select non-contrast or fabric contrast 1. Refer to [ki.com/fabrics](http://ki.com/fabrics).
  - For yardage pricing, see Fabric Yardage Pricing page
- C** Select fabric contrast 2. Refer to [ki.com/fabrics](http://ki.com/fabrics).
  - For yardage pricing, see Fabric Yardage Pricing page
- D** Select base finish color. Refer to the **Product Color Options** page in this price list.
- E** Select armcap option.
  - WAC** - Wood armcaps (pair)
  - SAC** - Solid surface armcaps; add \$818
  - PACBL** - Black poly armcap; add \$134
  - PACSA** - Sand poly; add \$134
  - PACWG** - Warm Grey poly; add \$134
  - Solid surface armcap color is always Corian™

- white.
- F** Select wood finish color. Refer to the **Product Color Options** page in this price list. For Kensington Maple add upcharge.
- G** Select nylon glide color.
  - NGFN** - Flannel (Dark Grey)
  - NGNT** - Natural (Cream)
- H** Select moisture barrier.
  - MB** - Moisture barrier
  - NMB** - No moisture barrier
  - See pricing column for moisture barrier upcharge.

**KENSINGTON MAPLE UPCHARGE**

Kensington Maple requires extended leadtimes.

Model	Price
SLOM23	\$79
SLOM33	\$79
SLOM43	\$79
SLPM23	\$79
SLPM33	\$79
SLPM43	\$79

**SPECIAL SERVICES**

**Special Carton Marking**

With specially marked information N/C

**Shipping**  
Ships **assembled, FOB High Point, NC 27263, freight prepaid.** Freight class 175

Specifications and prices are subject to change without prior notice.



MODEL	Features	MODEL NUMBER					Approx. Packaged Weight	Delivered Pricing	Moisture Barrier add to list price
		Basic Model	Non-Contrast or Fabric Contrast 1	Base Finish	Glide Color	Moisture Barrier			
 SMLS <b>Lounge Ottoman</b> • Non-contrast C.O.M = 1.5 yd • W=22-1/2" D=22" H=18"	Non-contrast	SM20	<input type="checkbox"/> <input type="checkbox"/> <input type="checkbox"/> <input type="checkbox"/>	<input type="checkbox"/> <input type="checkbox"/>	<input type="checkbox"/> <input type="checkbox"/>	<input type="checkbox"/> <input type="checkbox"/> <input type="checkbox"/>	35.00#	\$ 995	\$ 224

**HOW TO ORDER**

- Indicate the following information on order form:
- Quantity of each item.
  - Model number, including options. See "How To Build a Model Number".
  - Any special service required.

Note:

- The  indicates that a choice is required.
- The absence of the  indicates that no choice is required.
- Alpha-numeric characters in place of  indicate that no other alternatives are available.

**HOW TO BUILD A MODEL NUMBER**

- A** Select basic model.
- B** Select non-contrast or fabric contrast 1. Refer to [ki.com/fabrics](http://ki.com/fabrics).  
• For yardage pricing, see Fabric Yardage Pricing page
- C** Select base finish color. Refer to the **Product Color Options** page in this price list.
- D** Select nylon glide color.  
**NGFN** - Flannel (Dark Grey)  
**NGNT** - Natural (Cream)
- E** Select moisture barrier.  
**MB** - Moisture barrier  
**NMB** - No moisture barrier  
See pricing column for moisture barrier upcharge.

**SPECIAL SERVICES**

**Special Carton Marking**

With specially marked information N/C

**Shipping**

Ships **assembled, FOB High Point, NC 27263, freight prepaid.** Freight class 175

Specifications and prices are subject to change without prior notice.



### Occasional Tables

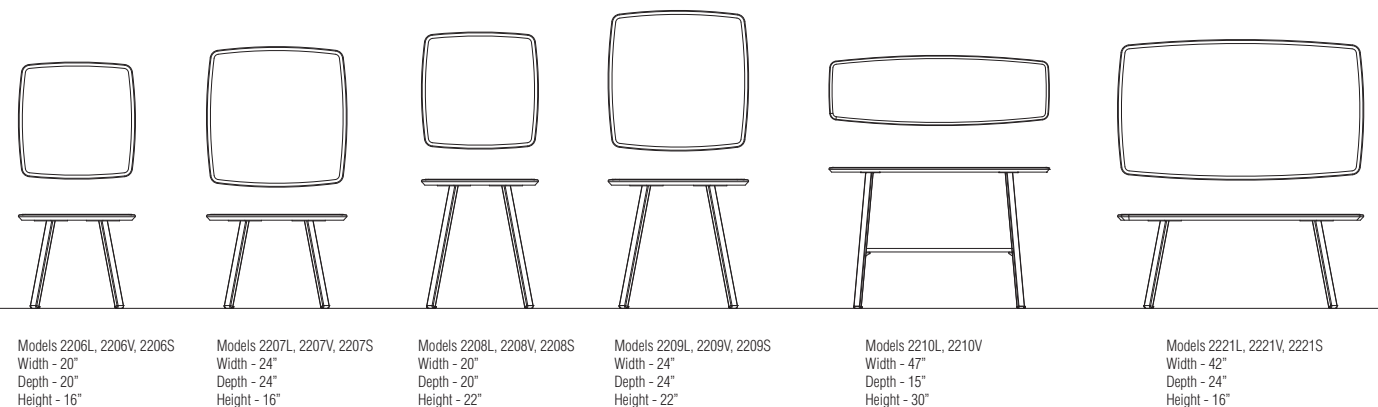
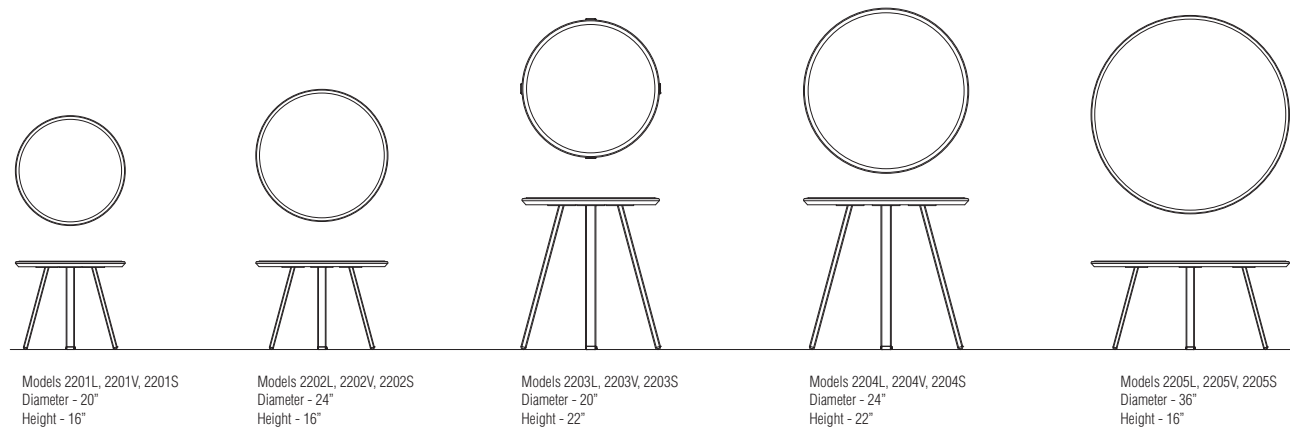

### Occasional Table Edge Styles

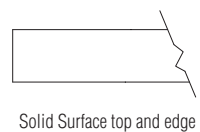
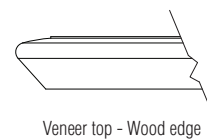
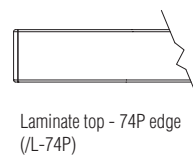
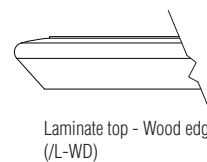



<b>Base Finish</b>	
Black	BL
Blue Grey	GR
Bronze Metallic	ZM
Cayenne	CY
Champagne Metallic	CM
Cool Grey	CG
Cottonwood	CO
Earthen Clay	EY
Espresso Metallic	EX
Everglade Shade	EV
Flannel	FN
Glitz Metallic	GZ
Hazy Jade	HJ
Honey Bee	HY
Light Tone	LG
Mardi Gras	MG
Misty Brown	MY
Nemo	NE
Nordic	ND
Poppy Red	PR
Purple Haze	PH
Rainforest	RQ
Raw Jasper	RJ
Rubber Ducky	RK
Sand	SA
Sky Blue	SK
Starlight Silver Metallic	SX
Surf's Up	SP
Tarragon	TQ
Twilight Shadow	TI
Ultra Blue	UB
Warm Grey	WG
Zesty Lime	ZL

<b>Glide Color</b>	<b>Edge Color for WD (Wood) Edge</b>
Flannel (Dark Grey)	NGFN
Natural (Cream)	NGNT

<b>Edge Color for 74P Edge</b>	<b>Surface Finish--Grade 1 Standard Laminate</b>
Akira	EAK
Beigewood	EBZ
Belair	EBQ
Biltmore Cherry	EBT
Black	EBL
Black Hills Oak	EBH
Blue Grey	EGR
Brighton Walnut	EBW
Castle Oak	ECO
Cayenne	ECY
Cherry Storm	ECX
Cocobala	ECC
Cool Grey	ECG
Cumberland Walnut	ECJ
Dering Forest	EDF
Designer White	EDR
Everglade Shade	EEV
Fawn Cypress	EFQ

<b>Surface Finish--Grade 2 Standard Laminate</b>	<b>Surface Finish--Grade 3 Standard Laminate</b>
Akira	BCX
Black Alicante	BCN
Black Hills Oak	BCA
Calcutta Marble	BEB
Dering Forest	BFC
Fawn Cypress	MMA
Ice Mist	BMT
Markerboard White	BNA
Valley Forge Elm	BRY
White River Forest	
	LBZ
	LBQ
	LBT
	LBK
	LBW
	LCO
	LCX
	LCI
	LCC
	LRI
	LDR

EFN	Dove Grey	LDG
EFC	Florence Walnut	LFC
EFH	Friston Ash	LFH
EFW	Frosty White	LFW
EHW	Graphite Nebula	LGN
EJH	Grey	LGE
EIT	High Rise	LHE
EKM	Hollyberry	LHY
ELG	Island	LID
EMG	Italian Silver Ash	LIT
EMY	Kensington Maple	LKM
EMT	Lapis Blue	LLB
EMB	Monticello Maple	LMT
ENE	North Sea	LNA
END	Ocean	LON
EPW	Pinnacle Walnut	LPW
EPR	River Cherry	LRY
ERQ	Shadow Zephyr	LSR
ERW	Sterling Ash	LAZ
ERY	Titanium Evolv	LTV
ERK	White Nebula	LWL
ESA	White Sand	LWN
ESK	Windsor Mahogany	LWY

ESG		
EAZ		
ESP		LAK
ETQ		LBY
ETI		LBH
EUB		LCQ
EVF		LDF
EWG		LFQ
EWR		LIM
EWY		LMK
EZL		LVF
		LWR

## Finish Cards

View color swatches for items listed within this document.

[Paints](#)      [Wood/Veneer](#)      [Molded Edges](#)      [Hard Plastics](#)  
[Plastics/Poly](#)      [Laminates](#)      [Edge Styles](#)      [Glass](#)

Certain options referenced may not be available on GSA Schedule.

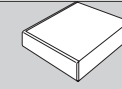
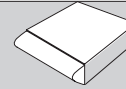

MODEL	W x D	MODEL NUMBER						Approx. Packaged Weight	Wood Edge (WD)	74P Edge (74P)	Laminate Grade 2 add to list price	Laminate Grade 3 add to list price	
		Basic Model	Base Finish	Laminate Color	Edge Style	Edge Color	Glide Color						
 SMFT	Square Club Table (Laminate Top) - 16" High	20" x 20"	2206/L	<input type="checkbox"/>	<input type="checkbox"/>	<input type="checkbox"/>	<input type="checkbox"/>	<input type="checkbox"/>	30.00#	\$ 1125	\$ 827	\$ 19	\$ 120
 SMFT	Square Club Table (Laminate Top) - 22" High	20" x 20"	2208/L	<input type="checkbox"/>	<input type="checkbox"/>	<input type="checkbox"/>	<input type="checkbox"/>	<input type="checkbox"/>	35.00#	\$ 1152	\$ 943	\$ 19	\$ 120
 SMFT	Round Club Table (Laminate Top) - 16" High	20" Diameter	2201/L	<input type="checkbox"/>	<input type="checkbox"/>	<input type="checkbox"/>	<input type="checkbox"/>	<input type="checkbox"/>	30.00#	\$ 1061	\$ 904	\$ 19	\$ 120
 SMFT	Round Club Table (Laminate Top) - 22" High	20" Diameter	2203/L	<input type="checkbox"/>	<input type="checkbox"/>	<input type="checkbox"/>	<input type="checkbox"/>	<input type="checkbox"/>	32.00#	\$ 1087	\$ 934	\$ 19	\$ 120

**A** **B** **C** **D** **E** **F**

**HOW TO ORDER**

- Indicate the following information on order form:
- Quantity of each item.
  - Model number, including options. See "How To Build a Model Number".
  - Any special service required.

Note:

- The  indicates that a choice is required.
- The absence of the  indicates that no choice is required.
- Alpha-numeric characters in place of  indicate that no other alternatives are available.

**HOW TO BUILD A MODEL NUMBER**

- A** Select basic model.
- B** Select base finish. Refer to the **Product Color Options** page in this price list.
- C** Select laminate color. Refer to the **Product Color Options** page in this price list.
- D** Select edge style.
 

<b>74P</b>	- 74P edge
<b>WD</b>	- WD edge
- E** Select edge color. Refer to the **Product Color Options** page in this price list. Edge color offerings are based on edge style selections.
- F** Select nylon glide color.
 

<b>NGFN</b>	- Flannel (Dark Grey)
<b>NGNT</b>	- Natural (Cream)

**KENSINGTON MAPLE UPCHARGE**

Kensington Maple requires extended leadtimes. Model

2201/L-WD	\$113
2202/L-WD	\$149
2203/L-WD	\$113
2204/L-WD	\$149
2205/L-WD	\$224
2206/L-WD	\$113
2207/L-WD	\$149
2208/L-WD	\$113
2209/L-WD	\$149
2210/L-WD	\$294
2221/L-WD	\$224

**FINISH INFORMATION**

**ADDITIONAL LAMINATE OFFERING**

KI offers laminates beyond those offered in the standard offering. Laminates that are currently available in the program can be viewed in KI product specification tools. Requests to add laminates to the program can be submitted via the product modification request process. Please note, requests to add laminates to the program must include the laminate manufacturers name, color/pattern number, and finish code. Edge options are limited to standard edge colors. If a matching edge is required, this will need to be requested thru the product modification request process and may be subject to additional costs. Due to varying manufacturing processes and quality issues with some laminates, some requests may be denied. Extended lead times and minimum order quantities may apply on orders containing special laminates. Contact the product modification team for questions or additional information regarding special laminates and pricing.

**SPECIAL SERVICES**





**Special Carton Marking**

With specially marked information N/C

**Shipping**  
Ships **assembled, FOB High Point, NC 27263, freight prepaid.** Freight class 175

Specifications and prices are subject to change without prior notice.



MODEL	W x D	MODEL NUMBER						Approx. Packaged Weight	Wood Edge (WD)	74P Edge (74P)	Laminate Grade 2 add to list price	Laminate Grade 3 add to list price	
		Basic Model	Base Finish	Laminate Color	Edge Style	Edge Color	Glide Color						
 SMFT	Square Lamp Table (Laminate Top) - 16" High	24" x 24"	2207/L	<input type="checkbox"/>	<input type="checkbox"/>	<input type="checkbox"/>	<input type="checkbox"/>	<input type="checkbox"/>	40.0#	\$ 1252	\$ 1007	\$ 19	\$ 120
 SMFT	Square Lamp Table (Laminate Top) - 22" High	24" x 24"	2209/L	<input type="checkbox"/>	<input type="checkbox"/>	<input type="checkbox"/>	<input type="checkbox"/>	<input type="checkbox"/>	40.0#	\$ 1277	\$ 982	\$ 19	\$ 120
 SMFT	Round Lamp Table (Laminate Top) - 16" High	24" Diameter	2202/L	<input type="checkbox"/>	<input type="checkbox"/>	<input type="checkbox"/>	<input type="checkbox"/>	<input type="checkbox"/>	35.0#	\$ 1166	\$ 945	\$ 19	\$ 120
 SMFT	Round Lamp Table (Laminate Top) - 22" High	24" Diameter	2204/L	<input type="checkbox"/>	<input type="checkbox"/>	<input type="checkbox"/>	<input type="checkbox"/>	<input type="checkbox"/>	50.0#	\$ 1193	\$ 973	\$ 19	\$ 120

**A** **B** **C** **D** **E** **F**

**HOW TO ORDER**

- Indicate the following information on order form:
- Quantity of each item.
  - Model number, including options. See "How To Build a Model Number".
  - Any special service required.

Note:

- The  indicates that a choice is required.
- The absence of the  indicates that no choice is required.
- Alpha-numeric characters in place of  indicate that no other alternatives are available.

**HOW TO BUILD A MODEL NUMBER**

- A** Select basic model.
- B** Select base finish. Refer to the **Product Color Options** page in this price list.
- C** Select laminate color. Refer to the **Product Color Options** page in this price list.
- D** Select edge style.
 

<b>WD</b>	- WD edge
<b>74P</b>	- 74P edge
- E** Select edge color. Refer to the **Product Color Options** page in this price list. Edge color offerings are based on edge style selections.
- F** Select nylon glide color.
 

<b>NGFN</b>	- Flannel (Dark Grey)
<b>NGNT</b>	- Natural (Cream)

**KENSINGTON MAPLE UPCHARGE**

Kensington Maple requires extended leadtimes.

Model	Price
2201/L-WD	\$113
2202/L-WD	\$149
2203/L-WD	\$113
2204/L-WD	\$149
2205/L-WD	\$224
2206/L-WD	\$113
2207/L-WD	\$149
2208/L-WD	\$113
2209/L-WD	\$149
2210/L-WD	\$294
2221/L-WD	\$224

**FINISH INFORMATION**

**ADDITIONAL LAMINATE OFFERING**

KI offers laminates beyond those offered in the standard offering. Laminates that are currently available in the program can be viewed in KI product specification tools. Requests to add laminates to the program can be submitted via the product modification request process. Please note, requests to add laminates to the program must include the laminate manufacturers name, color/pattern number, and finish code. Edge options are limited to standard edge colors. If a matching edge is required, this will need to be requested thru the product modification request process and may be subject to additional costs. Due to varying manufacturing processes and quality issues with some laminates, some requests may be denied. Extended lead times and minimum order quantities may apply on orders containing special laminates. Contact the product modification team for questions or additional information regarding special laminates and pricing.

**SPECIAL SERVICES**



**Special Carton Marking**

With specially marked information N/C

**Shipping**  
Ships **assembled, FOB High Point, NC 27263, freight prepaid.** Freight class 175

Specifications and prices are subject to change without prior notice.

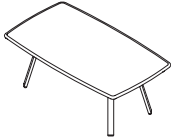

MODEL	W x D	MODEL NUMBER							Approx. Packaged Weight	Wood Edge (WD)	74P Edge (74P)	Laminate Grade 2 add to list price	Laminate Grade 3 add to list price
		Basic Model	Base Finish	Laminate Color	Edge Style	Edge Color	Shelf Edge Color	Glide Color					
 Rectangle Coffee Table (Laminate Top) - 16" High SMFT	42" x 24"	2221/L	<input type="checkbox"/>	<input type="checkbox"/>	<input type="checkbox"/>	<input type="checkbox"/>	<input type="checkbox"/>	<input type="checkbox"/>	60.0#	\$ 1721	\$ 1299	\$ 19	\$ 120
 Round Coffee Table (Laminate Top) - 16" High SMFT	36" Diameter	2205/L	<input type="checkbox"/>	<input type="checkbox"/>	<input type="checkbox"/>	<input type="checkbox"/>	<input type="checkbox"/>	<input type="checkbox"/>	65.0#	\$ 1728	\$ 1281	\$ 19	\$ 120
 Console Table (Laminate Top) - 30" High SMFT	47" x 15"	2210/L	<input type="checkbox"/>	<input type="checkbox"/>	<input type="checkbox"/>	<input type="checkbox"/>	<input type="checkbox"/>	<input type="checkbox"/>	65.0#	\$ 2075	\$ 1797	\$ 19	\$ 120

**A** **B** **C** **D** **E** **F** **G**

**HOW TO ORDER**

- Indicate the following information on order form:
- Quantity of each item.
  - Model number, including options. See "How To Build a Model Number".
  - Any special service required.

Note:

- The  indicates that a choice is required.
- The absence of the  indicates that no choice is required.
- Alpha-numeric characters in place of  indicate that no other alternatives are available.

**HOW TO BUILD A MODEL NUMBER**

- A** Select basic model.
- B** Select base finish. Refer to the **Product Color Options** page in this price list.
- C** Select laminate color. Refer to the **Product Color Options** page in this price list.
- D** Select edge style.
 

<b>WD</b>	- WD edge
<b>74P</b>	- 74P edge
- E** Select edge color. Refer to the **Product Color Options** page in this price list. Edge color offerings are based on edge style selections.

- F** Select lower shelf edge color. Refer to the **Product Color Options** page in this price list. Lower shelf has 74P edge and requires color pick when on laminate top.

- G** Select nylon glide color.
 

<b>NGFN</b>	- Flannel (Dark Grey)
<b>NGNT</b>	- Natural (Cream)

**KENSINGTON MAPLE UPCHARGE**

Kensington Maple requires extended leadtimes. Model

2201/L-WD	\$113
2202/L-WD	\$149
2203/L-WD	\$113
2204/L-WD	\$149
2205/L-WD	\$224
2206/L-WD	\$113
2207/L-WD	\$149
2208/L-WD	\$113
2209/L-WD	\$149
2210/L-WD	\$294
2221/L-WD	\$224

**FINISH INFORMATION**

**ADDITIONAL LAMINATE OFFERING**

KI offers laminates beyond those offered in the standard offering. Laminates that are currently available in the program can be viewed in KI product specification tools. Requests to add laminates to the program can be submitted via the product modification request process. Please note, requests to add laminates to the program must include the laminate manufacturers name, color/pattern number, and finish code. Edge options are limited to standard edge colors. If a matching edge is required, this will need to be requested thru the product modification request process and may be subject to additional costs. Due to varying manufacturing processes and quality issues with some laminates, some requests may be denied. Extended lead times and minimum order quantities may apply on orders containing special laminates. Contact the product modification team for questions or additional information regarding special laminates and pricing.

**SPECIAL SERVICES**





**Special Carton Marking**

With specially marked information N/C

**Shipping**  
Ships **assembled, FOB High Point, NC 27263, freight prepaid.** Freight class 175

Specifications and prices are subject to change without prior notice.



	MODEL	W x D	MODEL NUMBER				Approx. Packaged Weight	Delivered Pricing
			Basic Model	Base Finish	Surface Finish	Glide Color		
	Square Club Table (Veneer Top) - 16" High	20" x 20"	2206/V	<input type="checkbox"/>	<input type="checkbox"/>	<input type="checkbox"/>	30.0#	\$ 1218
SMFT								
	Square Club Table (Veneer Top) - 22" High	20" x 20"	2208/V	<input type="checkbox"/>	<input type="checkbox"/>	<input type="checkbox"/>	35.0#	\$ 1244
SMFT								
	Round Club Table (Veneer Top) - 16" High	20" Diameter	2201/V	<input type="checkbox"/>	<input type="checkbox"/>	<input type="checkbox"/>	30.0#	\$ 1342
SMFT								
	Round Club Table (Veneer Top) - 22" High	20" Diameter	2203/V	<input type="checkbox"/>	<input type="checkbox"/>	<input type="checkbox"/>	32.0#	\$ 1369
SMFT								

**A** **B** **C** **D**

**HOW TO ORDER**

- Indicate the following information on order form:
- Quantity of each item.
  - Model number, including options. See "How To Build a Model Number".
  - Any special service required.

Note:

- The  indicates that a choice is required.
- The absence of the  indicates that no choice is required.
- Alpha-numeric characters in place of  indicate that no other alternatives are available.

**HOW TO BUILD A MODEL NUMBER**

- A** Select basic model.
- B** Select base finish. Refer to the **Product Color Options** page in this price list.
- C** Select surface finish. Refer to the **Product Color Options** page in this price list.
- D** Select nylon glide color.
 

<b>NGFN</b>	- Flannel (Dark Grey)
<b>NGNT</b>	- Natural (Cream)

**KENSINGTON MAPLE UPCHARGE**

Kensington Maple requires extended leadtimes.

Model	Price
2201/V	\$113
2202/V	\$149
2203/V	\$113
2204/V	\$149
2205/V	\$224
2206/V	\$113
2207/V	\$149
2208/V	\$113
2209/V	\$149
2210/V	\$294
2221/V	\$224

**SPECIAL SERVICES**



**Special Carton Marking**

With specially marked information N/C

**Shipping**  
Ships **assembled, FOB High Point, NC 27263, freight prepaid.** Freight class 175

Specifications and prices are subject to change without prior notice.

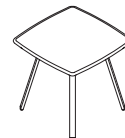

MODEL	W x D	MODEL NUMBER				Approx. Packaged Weight	Delivered Pricing
		Basic Model	Base Finish	Surface Finish	Glide Color		
 SMFT Square Lamp Table (Veneer Top) - 16" High	24" x 24"	2207/V	<input type="checkbox"/>	<input type="checkbox"/>	<input type="checkbox"/>	40.0#	\$ 1330
 SMFT Square Lamp Table (Veneer Top) - 22" High	24" x 24"	2209/V	<input type="checkbox"/>	<input type="checkbox"/>	<input type="checkbox"/>	40.0#	\$ 1357
 SMFT Round Lamp Table (Veneer Top) - 16" High	24" Diameter	2202/V	<input type="checkbox"/>	<input type="checkbox"/>	<input type="checkbox"/>	35.0#	\$ 1453
 SMFT Round Lamp Table (Veneer Top) - 22" High	24" Diameter	2204/V	<input type="checkbox"/>	<input type="checkbox"/>	<input type="checkbox"/>	50.0#	\$ 1477

**A** **B** **C** **D**

**HOW TO ORDER**

- Indicate the following information on order form:
- Quantity of each item.
  - Model number, including options. See "How To Build a Model Number".
  - Any special service required.

Note:

- The  indicates that a choice is required.
- The absence of the  indicates that no choice is required.
- Alpha-numeric characters in place of  indicate that no other alternatives are available.

**HOW TO BUILD A MODEL NUMBER**

- A** Select basic model.
- B** Select base finish. Refer to the **Product Color Options** page in this price list.
- C** Select surface finish. Refer to the **Product Color Options** page in this price list.
- D** Select nylon glide color.
 

<b>NGFN</b>	- Flannel (Dark Grey)
<b>NGNT</b>	- Natural (Cream)

**KENSINGTON MAPLE UPCHARGE**

Kensington Maple requires extended leadtimes.

Model	Price
2201/V	\$113
2202/V	\$149
2203/V	\$113
2204/V	\$149
2205/V	\$224
2206/V	\$113
2207/V	\$149
2208/V	\$113
2209/V	\$149
2210/V	\$294
2221/V	\$224

**SPECIAL SERVICES**



**Special Carton Marking**

With specially marked information N/C

**Shipping**  
Ships assembled, FOB High Point, NC 27263, freight prepaid. Freight class 175

Specifications and prices are subject to change without prior notice.

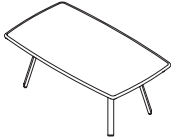

MODEL	W x D	MODEL NUMBER				Approx. Packaged Weight	Delivered Pricing
		Basic Model	Base Finish	Surface Finish	Glide Color		
 Rectangle Coffee Table (Veneer Top) - 16" High SMFT	42" x 24"	2221/V	<input type="checkbox"/>	<input type="checkbox"/>	<input type="checkbox"/>	60.0#	\$ 1563
 Round Coffee Table (Veneer Top) - 16" High SMFT	36" Diameter	2205/V	<input type="checkbox"/>	<input type="checkbox"/>	<input type="checkbox"/>	65.0#	\$ 1772
 Console Table (Veneer Top) - 30" High SMFT	47" x 15"	2210/V	<input type="checkbox"/>	<input type="checkbox"/>	<input type="checkbox"/>	65.0#	\$ 2380

**A**   **B**   **C**   **D**

**HOW TO ORDER**

- Indicate the following information on order form:
- Quantity of each item.
  - Model number, including options. See "How To Build a Model Number".
  - Any special service required.

Note:

- The  indicates that a choice is required.
- The absence of the  indicates that no choice is required.
- Alpha-numeric characters in place of  indicate that no other alternatives are available.

**HOW TO BUILD A MODEL NUMBER**

- A** Select basic model.
- B** Select base finish. Refer to the **Product Color Options** page in this price list.
- C** Select surface finish. Refer to the **Product Color Options** page in this price list.
- D** Select nylon glide color.
 

<b>NGFN</b>	- Flannel (Dark Grey)
<b>NGNT</b>	- Natural (Cream)

**KENSINGTON MAPLE UPCHARGE**

Kensington Maple requires extended leadtimes.

Model	Price
2201/V	\$113
2202/V	\$149
2203/V	\$113
2204/V	\$149
2205/V	\$224
2206/V	\$113
2207/V	\$149
2208/V	\$113
2209/V	\$149
2210/V	\$294
2221/V	\$224

**SPECIAL SERVICES**





**Special Carton Marking**

With specially marked information    N/C

**Shipping**  
Ships **assembled, FOB High Point, NC 27263, freight prepaid.** Freight class 175

Specifications and prices are subject to change without prior notice.



	MODEL	W x D	MODEL NUMBER			Approx. Packaged Weight	Delivered Pricing
			Basic Model	Base Finish	Glide Color		
	<b>Square Club Table (Solid Surface Top) - 16" High</b> • Solid surface color is always Corian™ glacier white.	20" x 20"	2206/S	<input type="checkbox"/>	<input type="checkbox"/>	30.0#	\$ 1772
SMFT							
	<b>Square Club Table (Solid Surface Top) - 22" High</b> • Solid surface color is always Corian™ glacier white.	20" x 20"	2208/S	<input type="checkbox"/>	<input type="checkbox"/>	35.0#	\$ 1808
SMFT							
	<b>Round Club Table (Solid Surface Top) - 16" High</b> • Solid surface color is always Corian™ glacier white.	20" Diameter	2201/S	<input type="checkbox"/>	<input type="checkbox"/>	30.0#	\$ 1772
SMFT							
	<b>Round Club Table (Solid Surface Top) - 22" High</b> • Solid surface color is always Corian™ glacier white.	20" Diameter	2203/S	<input type="checkbox"/>	<input type="checkbox"/>	32.0#	\$ 1808
SMFT							

**A** **B** **C**

**HOW TO ORDER**

- Indicate the following information on order form:
- Quantity of each item.
  - Model number, including options. See "How To Build a Model Number".
  - Any special service required.

Note: • The  indicates that a choice is required.  
• The absence of the  indicates that no choice is required.  
• Alpha-numeric characters in place of  indicate that no other alternatives are available.

**HOW TO BUILD A MODEL NUMBER**

- A** Select basic model.
- B** Select base finish.  
Refer to the **Product Color Options** page in this price list.
- C** Select nylon glide color.  
**NGFN** - Flannel (Dark Grey)  
**NGNT** - Natural (Cream)

**SPECIAL SERVICES**





**Special Carton Marking**

With specially marked information N/C

**Shipping**  
Ships **assembled, FOB High Point, NC 27263, freight prepaid.** Freight class 175

Specifications and prices are subject to change without prior notice.



MODEL	W x D	MODEL NUMBER			Approx. Packaged Weight	Delivered Pricing
		Basic Model	Base Finish	Glide Color		
 SMFT <b>Square Lamp Table (Solid Surface Top) - 16" High</b> • Solid surface color is always Corian™ glacier white.	24" x 24"	2207/S	<input type="checkbox"/>	<input type="checkbox"/>	40.0#	\$ 2301
 SMFT <b>Square Lamp Table (Solid Surface Top) - 22" High</b> • Solid surface color is always Corian™ glacier white.	24" x 24"	2209/S	<input type="checkbox"/>	<input type="checkbox"/>	40.0#	\$ 2339
 SMFT <b>Round Lamp Table (Solid Surface Top) - 16" High</b> • Solid surface color is always Corian™ glacier white.	24" Diameter	2202/S	<input type="checkbox"/>	<input type="checkbox"/>	35.0#	\$ 2010
 SMFT <b>Round Lamp Table (Solid Surface Top) - 22" High</b> • Solid surface color is always Corian™ glacier white.	24" Diameter	2204/S	<input type="checkbox"/>	<input type="checkbox"/>	50.0#	\$ 2046

**A**   **B**   **C**

**HOW TO ORDER**

- Indicate the following information on order form:
- Quantity of each item.
  - Model number, including options. See "How To Build a Model Number".
  - Any special service required.

Note: • The  indicates that a choice is required.  
 • The absence of the  indicates that no choice is required.  
 • Alpha-numeric characters in place of  indicate that no other alternatives are available.

**HOW TO BUILD A MODEL NUMBER**

- A** Select basic model.
- B** Select base finish.  
Refer to the **Product Color Options** page in this price list.
- C** Select nylon glide color.  

<b>NGFN</b>	- Flannel (Dark Grey)
<b>NGNT</b>	- Natural (Cream)

**SPECIAL SERVICES**



**Special Carton Marking**

With specially marked information    N/C

**Shipping**  
 Ships **assembled, FOB High Point, NC 27263, freight prepaid.** Freight class 175

Specifications and prices are subject to change without prior notice.



	MODEL	W x D	MODEL NUMBER			Approx. Packaged Weight	Delivered Pricing
			Basic Model	Base Finish	Glide Color		
 SMFT	<b>Rectangle Coffee Table (Solid Surface Top) - 16" High</b> • Solid surface color is always Corian™ glacier white.	42" x 24"	2221/S	<input type="checkbox"/>	<input type="checkbox"/>	60.0#	\$ 2898
 SMFT	<b>Round Coffee Table (Solid Surface Top) - 16" High</b> • Solid surface color is always Corian™ glacier white.	36" Diameter	2205/S	<input type="checkbox"/>	<input type="checkbox"/>	65.0#	\$ 3170

**A**   **B**   **C**

**HOW TO ORDER**

- Indicate the following information on order form:
- Quantity of each item.
  - Model number, including options. See "How To Build a Model Number".
  - Any special service required.

Note:

- The  indicates that a choice is required.
- The absence of the  indicates that no choice is required.
- Alpha-numeric characters in place of  indicate that no other alternatives are available.

**HOW TO BUILD A MODEL NUMBER**

- A** Select basic model.
- B** Select base finish.  
Refer to the **Product Color Options** page in this price list.
- C** Select nylon glide color.  

<b>NGFN</b>	- Flannel (Dark Grey)
<b>NGNT</b>	- Natural (Cream)

**SPECIAL SERVICES**

**Special Carton Marking**

With specially marked information    N/C

**Shipping**  
Ships **assembled, FOB High Point, NC 27263, freight prepaid.** Freight class 175

Specifications and prices are subject to change without prior notice.



1330 BELLEVUE STREET  
GREEN BAY, WI 54302  
800.424.2432 / KI.COM

KI is a trusted expert for furniture and wall systems around the globe.  
USA | CANADA | MEXICO | UK | EUROPE | ASIA | MIDDLE EAST  
© 2026 Krueger International, Inc. All Rights Reserved.