



ACCESSORIES

PRICE LIST

EFFECTIVE MARCH 25, 2026
800.424.2432



All Terrain® Screens	
General Information	3
Product Color Options	4
Full-Height Core with Four-Point Base	5
Full-Height Core with Three-Point Base	6
Accessories	7
Rails for Paper Management Tools	
General Information	8
Product Color Options	9
Wall Rail	10
Panel Rail	11
Worksurface Accessories	
Keyboard Tray with Trackless Arm	12
Corner Worksurface Keyboard Trays	13
Keyboard Trays with Standard Arms	17
Keyboard Drawer	20
CPU Sling	21
Adjustable/Securable CPU Holder	22
Compact CPU Holder	23
Mini CPU Holder	24
Pneumatic Monitor Arm	
Extended Arm	25
Monitor Arms	
26	
Power Module and Electrical Accessories	
Product Color Options	31
Accessory Power Modules	
Drop-in USB Charger	32
Ashley Duo™ Module General Information	33
Ashley Duo™ Module	34
Layer Power Tower	36
PowerUp®	37
Undermount R8 Module	38
Dean Clamp-on Module	39
Dean In-surface Module	40
Dean Undersurface Module	41
Dubbel Undersurface Module	42
Nacre Pop-up Module	43
Node In-surface Module	44
Thesis Battery Module	45
Thesis Electrical Accessories	47
Vesta Battery Power Tower	48
Electrical Accessories	
49	



SCREENS

standard with the same fabric on both sides of the cores.

Screen Frame

Screens shall be available in the following sizes: heights of 54" and 66"; widths of 24", 30", 36", 42" and 48".

The framework shall be constructed of extruded aluminum horizontal and vertical members. The framework shall have a powder-coat finish.

Foot and Peg Legs

The screen shall be available with four contact points with the floor, which is made up of two feet. 24" and 30" wide screens shall be available with three points of contact with the floor, which is made up of one foot and one peg leg.

The foot and peg leg shall be constructed of molded aluminum with a powder-coat finish. The foot and peg leg shall be fastened to the vertical and horizontal framework and will support the screen. The foot and peg leg will provide sufficient clearance to allow nesting of screens for storage purposes.

Casters

Casters shall be available for the screen. Four large twin-wheel casters shall be constructed with 70mm (2-3/4") diameter black tread and black hub. Casters shall have a swivel radius of 2-1/2". Casters shall be available in both locking and nonlocking swivel versions.

There shall be three caster options available to use with the feet and peg leg combinations: three casters are specified; two locking and one-swivel casters are used. When four casters are specified, two locking and two swivel casters are used. When two casters and one glide are specified, two locking casters are used with one glide.

Glides

Screens shall also be available with telescoping glides. Glides shall have a nominal mounting height (3-1/4") equal to the caster height, allowing casters and glides to be interchangeable without changing the screen height. Glides shall be adjustable by 1/2" from the nominal position. Each glide shall include a telescoping hood that maintains contact with the bottom of the foot or peg leg. Glide base shall be KI Glacier white molded nylon. Glide body and telescoping hood shall be black nylon. Glide base diameter shall be 2-3/4".

There shall be three glide options available to use with the feet and peg leg combinations: three glides, two casters and one glide, or four glides.

Fabric Core

The fabric screen core shall be constructed of mineral fiberboard, a fiberglass matting overlay with the fiber adhered to both sides. The finished thickness shall be 1/2". The core shall be trapped in the screen framework. The fabric core is

Markerboard Core

The markerboard core shall be constructed of 20-gauge painted steel adhered to both sides of a corrugate core to a finished thickness of 1/2". The paint shall be colormatched to the white porcelain paint finish of other KI markerboard products. The core shall be trapped in the screen framework.

Clear Plastic Core

The clear plastic core shall be constructed of fluted, extruded, clear polycarbonate. It shall be extruded to a 10mm thickness. The core shall be trapped in the screen framework.

Edge Trim

The vertical frame extrusion shall receive a powder coated aluminum edge trim.

Full-Height Core Screen

The full-height core screens shall extend from the top of the screen's framework to the bottom of the screen's framework. Core options of fabric, markerboard, and clear plastic shall be available.

Fabric

Fabric will be applied as swatched by the fabric manufacturer. Fabric that is required to be applied differently than is swatched will need a Product Modification Request written specifying the direction the fabric is to be applied.



Paint Color

Black	BL
Blue Grey	GR
Bronze Metallic	ZM
Cayenne	CY
Champagne Metallic	CM
Cool Grey	CG
Cottonwood	CO
Earthen Clay	EY
Espresso Metallic	EX
Everglade Shade	EV
Flannel	FN
Glitz Metallic	GZ
Hazy Jade	HJ
Honey Bee	HY
Light Tone	LG
Mardi Gras	MG
Misty Brown	MY
Nemo	NE
Nordic	ND
Poppy Red	PR
Purple Haze	PH
Rainforest	RQ
Raw Jasper	RJ
Rubber Ducky	RK
Sand	SA
Sky Blue	SK
Starlight Silver Metallic	SX
Surf's Up	SP
Tarragon	TQ
Twilight Shadow	TI
Ultra Blue	UB
Warm Grey	WG
Zesty Lime	ZL

Finish Cards

View color swatches for items listed within this document.

Paints

Plastics/Poly

Wood/Veneer

Laminates

Molded Edges

Edge Styles

Hard Plastics

Glass

Certain options referenced may not be available on GSA Schedule.



MODEL	W x D x H	MODEL NUMBER				Approx. Packaged Weight	Delivered Pricing Unupholstered	Delivered Pricing Fabric Grade 1 & C.O.M.	Delivered Pricing Fabric Grade 2	Delivered Pricing Fabric Grade 3 & Pallas Vertical Fabric Grade PV	Delivered Pricing Pallas Vertical Fabric Grade PV1	Delivered Pricing Pallas Vertical Fabric Grade PV2
		Basic Model	Base	Paint Color	Fabric Color							
<p>Fluted Plastic Core - Four-Point Base (CP)</p> <ul style="list-style-type: none"> Aluminum frame Cast aluminum legs Trim will match paint color Casters or glides Core material same on both sides 	24 x 16 x 54"	ATS42454FHC/CP	<input type="checkbox"/> <input type="checkbox"/> <input type="checkbox"/>	<input type="checkbox"/> <input type="checkbox"/>		18.0#	\$ 1167					
	24 x 16 x 66"	ATS42466FHC/CP	<input type="checkbox"/> <input type="checkbox"/> <input type="checkbox"/>	<input type="checkbox"/> <input type="checkbox"/>		20.0#	1177					
	30 x 16 x 54"	ATS43054FHC/CP	<input type="checkbox"/> <input type="checkbox"/> <input type="checkbox"/>	<input type="checkbox"/> <input type="checkbox"/>		18.0#	1248					
	30 x 16 x 66"	ATS43066FHC/CP	<input type="checkbox"/> <input type="checkbox"/> <input type="checkbox"/>	<input type="checkbox"/> <input type="checkbox"/>		21.0#	1252					
	36 x 16 x 54"	ATS43654FHC/CP	<input type="checkbox"/> <input type="checkbox"/> <input type="checkbox"/>	<input type="checkbox"/> <input type="checkbox"/>		19.0#	1305					
	36 x 16 x 66"	ATS43666FHC/CP	<input type="checkbox"/> <input type="checkbox"/> <input type="checkbox"/>	<input type="checkbox"/> <input type="checkbox"/>		22.0#	1338					
	42 x 16 x 54"	ATS44254FHC/CP	<input type="checkbox"/> <input type="checkbox"/> <input type="checkbox"/>	<input type="checkbox"/> <input type="checkbox"/>		20.0#	1362					
	42 x 16 x 66"	ATS44266FHC/CP	<input type="checkbox"/> <input type="checkbox"/> <input type="checkbox"/>	<input type="checkbox"/> <input type="checkbox"/>		23.0#	1391					
	48 x 16 x 54"	ATS44854FHC/CP	<input type="checkbox"/> <input type="checkbox"/> <input type="checkbox"/>	<input type="checkbox"/> <input type="checkbox"/>		21.0#	1402					
	48 x 16 x 66"	ATS44866FHC/CP	<input type="checkbox"/> <input type="checkbox"/> <input type="checkbox"/>	<input type="checkbox"/> <input type="checkbox"/>		24.0#	1417					
<p>Fabric-Covered Tackboard Core - Four-Point Base (FB)</p> <ul style="list-style-type: none"> Aluminum frame Cast aluminum legs Trim will match paint color Casters or glides Core material same on both sides 	24 x 16 x 54"	ATS42454FHC/FB	<input type="checkbox"/> <input type="checkbox"/> <input type="checkbox"/>	<input type="checkbox"/> <input type="checkbox"/>	<input type="checkbox"/> <input type="checkbox"/> <input type="checkbox"/> <input type="checkbox"/>	18.0#	N/A	\$ 1180	\$ 1199	\$ 1200	\$ 1207	\$ 1253
	24 x 16 x 66"	ATS42466FHC/FB	<input type="checkbox"/> <input type="checkbox"/> <input type="checkbox"/>	<input type="checkbox"/> <input type="checkbox"/>	<input type="checkbox"/> <input type="checkbox"/> <input type="checkbox"/> <input type="checkbox"/>	20.0#	N/A	1186	1205	1207	1217	1262
	30 x 16 x 54"	ATS43054FHC/FB	<input type="checkbox"/> <input type="checkbox"/> <input type="checkbox"/>	<input type="checkbox"/> <input type="checkbox"/>	<input type="checkbox"/> <input type="checkbox"/> <input type="checkbox"/> <input type="checkbox"/>	18.0#	N/A	1262	1279	1283	1293	1336
	30 x 16 x 66"	ATS43066FHC/FB	<input type="checkbox"/> <input type="checkbox"/> <input type="checkbox"/>	<input type="checkbox"/> <input type="checkbox"/>	<input type="checkbox"/> <input type="checkbox"/> <input type="checkbox"/> <input type="checkbox"/>	21.0#	N/A	1271	1290	1295	1305	1348
	36 x 16 x 54"	ATS43654FHC/FB	<input type="checkbox"/> <input type="checkbox"/> <input type="checkbox"/>	<input type="checkbox"/> <input type="checkbox"/>	<input type="checkbox"/> <input type="checkbox"/> <input type="checkbox"/> <input type="checkbox"/>	19.0#	N/A	1315	1353	1355	1372	1462
	36 x 16 x 66"	ATS43666FHC/FB	<input type="checkbox"/> <input type="checkbox"/> <input type="checkbox"/>	<input type="checkbox"/> <input type="checkbox"/>	<input type="checkbox"/> <input type="checkbox"/> <input type="checkbox"/> <input type="checkbox"/>	22.0#	N/A	1360	1391	1394	1410	1503
	42 x 16 x 54"	ATS44254FHC/FB	<input type="checkbox"/> <input type="checkbox"/> <input type="checkbox"/>	<input type="checkbox"/> <input type="checkbox"/>	<input type="checkbox"/> <input type="checkbox"/> <input type="checkbox"/> <input type="checkbox"/>	20.0#	N/A	1374	1405	1410	1430	1522
	42 x 16 x 66"	ATS44266FHC/FB	<input type="checkbox"/> <input type="checkbox"/> <input type="checkbox"/>	<input type="checkbox"/> <input type="checkbox"/>	<input type="checkbox"/> <input type="checkbox"/> <input type="checkbox"/> <input type="checkbox"/>	23.0#	N/A	1402	1437	1441	1459	1552
	48 x 16 x 54"	ATS44854FHC/FB	<input type="checkbox"/> <input type="checkbox"/> <input type="checkbox"/>	<input type="checkbox"/> <input type="checkbox"/>	<input type="checkbox"/> <input type="checkbox"/> <input type="checkbox"/> <input type="checkbox"/>	21.0#	N/A	1423	1453	1459	1477	1568
	48 x 16 x 66"	ATS44866FHC/FB	<input type="checkbox"/> <input type="checkbox"/> <input type="checkbox"/>	<input type="checkbox"/> <input type="checkbox"/>	<input type="checkbox"/> <input type="checkbox"/> <input type="checkbox"/> <input type="checkbox"/>	24.0#	N/A	1432	1463	1468	1489	1575
<p>Markerboard Core (Painted Steel) - Four-Point Base (MB)</p> <ul style="list-style-type: none"> Aluminum frame Cast aluminum legs Trim will match paint color Casters or glides Core material same on both sides 	24 x 16 x 54"	ATS42454FHC/MB	<input type="checkbox"/> <input type="checkbox"/> <input type="checkbox"/>	<input type="checkbox"/> <input type="checkbox"/>		31.0#	\$ 1178					
	24 x 16 x 66"	ATS42466FHC/MB	<input type="checkbox"/> <input type="checkbox"/> <input type="checkbox"/>	<input type="checkbox"/> <input type="checkbox"/>		37.0#	1181					
	30 x 16 x 54"	ATS43054FHC/MB	<input type="checkbox"/> <input type="checkbox"/> <input type="checkbox"/>	<input type="checkbox"/> <input type="checkbox"/>		36.0#	1258					
	30 x 16 x 66"	ATS43066FHC/MB	<input type="checkbox"/> <input type="checkbox"/> <input type="checkbox"/>	<input type="checkbox"/> <input type="checkbox"/>		43.0#	1264					
	36 x 16 x 54"	ATS43654FHC/MB	<input type="checkbox"/> <input type="checkbox"/> <input type="checkbox"/>	<input type="checkbox"/> <input type="checkbox"/>		41.0#	1311					
	36 x 16 x 66"	ATS43666FHC/MB	<input type="checkbox"/> <input type="checkbox"/> <input type="checkbox"/>	<input type="checkbox"/> <input type="checkbox"/>		49.0#	1353					
	42 x 16 x 54"	ATS44254FHC/MB	<input type="checkbox"/> <input type="checkbox"/> <input type="checkbox"/>	<input type="checkbox"/> <input type="checkbox"/>		45.0#	1367					
	42 x 16 x 66"	ATS44266FHC/MB	<input type="checkbox"/> <input type="checkbox"/> <input type="checkbox"/>	<input type="checkbox"/> <input type="checkbox"/>		56.0#	1399					
	48 x 16 x 54"	ATS44854FHC/MB	<input type="checkbox"/> <input type="checkbox"/> <input type="checkbox"/>	<input type="checkbox"/> <input type="checkbox"/>		50.0#	1417					
	48 x 16 x 66"	ATS44866FHC/MB	<input type="checkbox"/> <input type="checkbox"/> <input type="checkbox"/>	<input type="checkbox"/> <input type="checkbox"/>		62.0#	1428					

A **B** **C** **D**

HOW TO ORDER

- Indicate the following information on order form:
- Quantity of each item.
 - Model number, including options. See "How To Build a Model Number".
 - Any special service required.

Note:

- The indicates that a choice is required.
- The absence of the indicates that no choice is required.
- Alpha-numeric characters in place of indicate that no other alternatives are available.

HOW TO BUILD A MODEL NUMBER

- A** Select basic model.
- B** Select base style.

4CW	- 4 black casters (2 locking)
4GB	- 4 black glides
4MW	- 2 black casters, 2 black glides
- C** Select paint color. Refer to the **Product Color Options** page in this price list.
- D** Select fabric color. Refer to ki.com/fabrics

SPECIAL SERVICES

Special Carton Marking



With specially marked information N/C

Shipping

Ships **assembled, FOB Pembroke, ON K8A 0E1, freight prepaid.** Freight class 70.

Specifications and prices are subject to change without prior notice.

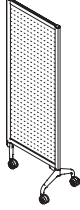

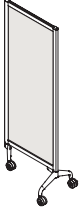
MODEL	W x D x H	MODEL NUMBER				Approx. Packaged Weight	Delivered Pricing Unupholstered	Delivered Pricing Fabric Grade 1 & C.O.M.	Delivered Pricing Fabric Grade 2	Delivered Pricing Fabric Grade 3 & Pallas Vertical Fabric Grade PV	Delivered Pricing Pallas Vertical Fabric Grade PV1	Delivered Pricing Pallas Vertical Fabric Grade PV2
		Basic Model	Base	Paint Color	Fabric Color							
 <p>Fluted Plastic Core - Three-point base (CP)</p> <ul style="list-style-type: none"> Aluminum frame Cast aluminum legs Trim will match paint color Casters or glides Core material same on both sides 	24 x 16 x 54"	ATS32454FHC/CP	<input type="checkbox"/> <input type="checkbox"/> <input type="checkbox"/>	<input type="checkbox"/> <input type="checkbox"/>		16.0#	\$ 1135					
	24 x 16 x 66"	ATS32466FHC/CP	<input type="checkbox"/> <input type="checkbox"/> <input type="checkbox"/>	<input type="checkbox"/> <input type="checkbox"/>		18.0#	1142					
	30 x 16 x 54"	ATS33054FHC/CP	<input type="checkbox"/> <input type="checkbox"/> <input type="checkbox"/>	<input type="checkbox"/> <input type="checkbox"/>		17.0#	1218					
	30 x 16 x 66"	ATS33066FHC/CP	<input type="checkbox"/> <input type="checkbox"/> <input type="checkbox"/>	<input type="checkbox"/> <input type="checkbox"/>		19.0#	1223					
 <p>Fabric-Covered Tackboard Core - Three-Point Base (FB)</p> <ul style="list-style-type: none"> Aluminum frame Cast aluminum legs Trim will match paint color Casters or glides Core material same on both sides 	24 x 16 x 54"	ATS32454FHC/FB	<input type="checkbox"/> <input type="checkbox"/> <input type="checkbox"/>	<input type="checkbox"/> <input type="checkbox"/>	<input type="checkbox"/> <input type="checkbox"/> <input type="checkbox"/> <input type="checkbox"/>	16.0#	N/A	\$ 1151	\$ 1170	\$ 1177	\$ 1181	\$ 1224
	24 x 16 x 66"	ATS32466FHC/FB	<input type="checkbox"/> <input type="checkbox"/> <input type="checkbox"/>	<input type="checkbox"/> <input type="checkbox"/>	<input type="checkbox"/> <input type="checkbox"/> <input type="checkbox"/> <input type="checkbox"/>	18.0#	N/A	1158	1178	1180	1186	1233
	30 x 16 x 54"	ATS33054FHC/FB	<input type="checkbox"/> <input type="checkbox"/> <input type="checkbox"/>	<input type="checkbox"/> <input type="checkbox"/>	<input type="checkbox"/> <input type="checkbox"/> <input type="checkbox"/> <input type="checkbox"/>	17.0#	N/A	1235	1253	1258	1266	1310
	30 x 16 x 66"	ATS33066FHC/FB	<input type="checkbox"/> <input type="checkbox"/> <input type="checkbox"/>	<input type="checkbox"/> <input type="checkbox"/>	<input type="checkbox"/> <input type="checkbox"/> <input type="checkbox"/> <input type="checkbox"/>	19.0#	N/A	1244	1260	1264	1271	1315
 <p>Markerboard Core (Painted Steel) - Three-Point Base (MB)</p> <ul style="list-style-type: none"> Aluminum frame Cast aluminum legs Trim will match paint color Casters or glides Core material same on both sides 	24 x 16 x 54"	ATS32454FHC/MB	<input type="checkbox"/> <input type="checkbox"/> <input type="checkbox"/>	<input type="checkbox"/> <input type="checkbox"/>		29.0#	\$ 1144					
	24 x 16 x 66"	ATS32466FHC/MB	<input type="checkbox"/> <input type="checkbox"/> <input type="checkbox"/>	<input type="checkbox"/> <input type="checkbox"/>		36.0#	1151					
	30 x 16 x 54"	ATS33054FHC/MB	<input type="checkbox"/> <input type="checkbox"/> <input type="checkbox"/>	<input type="checkbox"/> <input type="checkbox"/>		34.0#	1224					
	30 x 16 x 66"	ATS33066FHC/MB	<input type="checkbox"/> <input type="checkbox"/> <input type="checkbox"/>	<input type="checkbox"/> <input type="checkbox"/>		42.0#	1234					

A

B

C

D

HOW TO ORDER

Indicate the following information on order form:

- Quantity of each item.
- Model number, including options. See "How To Build a Model Number".
- Any special service required.

Note: • The indicates that a choice is required.

- The absence of the indicates that no choice is required.
- Alpha-numeric characters in place of indicate that no other alternatives are available.

HOW TO BUILD A MODEL NUMBER

A Select basic model.

B Select base style.

2C1 - 2 black locking casters, 1 glide

3CW - 3 black casters (2 locking)

3GB - 3 black glides

C Select paint color.

Refer to the **Product Color Options** page in this price list.

D Select fabric color.

Refer to ki.com/fabrics

SPECIAL SERVICES

Special Carton Marking





With specially marked information N/C

Shipping

Ships **assembled, FOB Pembroke, ON K8A 0E1, freight prepaid.** Freight class 70.

Specifications and prices are subject to change without prior notice.



		MODEL NUMBER			
MODEL	H	Basic Model	Approx. Packaged Weight	Delivered Pricing	
 ATA01	3" Caster Kit <ul style="list-style-type: none"> Kit includes two locking and two non-locking casters and stems Casters feature twin 2-15/16" diameter wheels Black hub, black caster 	3-3/8"H	2.KP80635	2.00#	\$ 47
 ATA01	Glides <ul style="list-style-type: none"> Same height as casters Provides 1/2" height adjustment 	3-3/8"H	2.KP103000BLWH	1.00#	\$ 46
 AC100	Magnetic Markerboard Tray2 <ul style="list-style-type: none"> One 16" magnetically mounted aluminum pen and eraser tray Clear aluminum anodized finish 	16 x 2-1/2"	MB.TRAY	1.00#	\$ 54
 AC100	Magnetic Markerboard Kit <ul style="list-style-type: none"> One 16" magnetically mounted aluminum pen and eraser tray with one eraser and four pens Clear aluminum anodized finish 		MB.MARKERKIT	1.00#	\$ 130

A

HOW TO ORDER

Indicate the following information on order form:

- Quantity of each item.
- Model number, including options. See "How To Build a Model Number".
- Any special service required.

Note:

- The indicates that a choice is required.
- The absence of the indicates that no choice is required.
- Alpha-numeric characters in place of indicate that no other alternatives are available.

HOW TO BUILD A MODEL NUMBER

A Select basic model.

SPECIAL SERVICES

Special Carton Marking

With specially marked information N/C

Shipping

Ships assembled, FOB Pembroke, ON K8A 0E1, freight prepaid, or Manitowoc, WI 54220 (MB-TRAY, MBMARKERKIT). Freight class 70.

Specifications and prices are subject to change without prior notice.

**Wall Rail**

The wall rail shall be constructed of two aluminum extrusions. One extrusion shall be fastened to the wall. The second extrusion shall be snapped onto the first extrusion. The second extrusion shall provide a means for displaying and storing KI paper management accessories.

The second extrusion shall have a machining operation performed on the end of it for aesthetic appeal and shall have a powder-coat finish. The extrusion shall be available in lengths of: 24", 36", 48", 72" and 96".

Panel Rail

The panel rail shall be constructed of one aluminum extrusion and two 16-gauge, cut and formed steel brackets. The extrusion shall mount to KI panel and wall systems.

The extrusion shall provide a means for displaying and storing KI paper management accessories. The extrusion shall have a machining operation performed on the end of it for aesthetic appeal and shall have a powder-coat finish. The extrusion shall be available in lengths of: 24", 36", 48", 72" and 96".

The extrusion shall slide along the brackets to allow for the extrusion to be "off-module" from the panel and wall system.



Paint Colors

Black	BL
Blue Grey	GR
Bronze Metallic	ZM
Cayenne	CY
Champagne Metallic	CM
Cool Grey	CG
Cottonwood	CO
Earthen Clay	EY
Espresso Metallic	EX
Everglade Shade	EV
Flannel	FN
Glitz Metallic	GZ
Hazy Jade	HJ
Honey Bee	HY
Light Tone	LG
Mardi Gras	MG
Misty Brown	MY
Nemo	NE
Nordic	ND
Poppy Red	PR
Purple Haze	PH
Rainforest	RQ
Raw Jasper	RJ
Rubber Ducky	RK
Sand	SA
Sky Blue	SK
Starlight Silver Metallic	SX
Surf's Up	SP
Tarragon	TQ
Twilight Shadow	TI
Ultra Blue	UB
Warm Grey	WG
Zesty Lime	ZL

Finish Cards

View color swatches for items listed within this document.

Paints

Plastics/Poly

Wood/Veneer

Laminates

Molded Edges

Edge Styles

Hard Plastics

Glass

Certain options referenced may not be available on GSA Schedule.



MODEL	W x D x H	MODEL NUMBER		Approx. Packaged Weight	Delivered Pricing
		Basic Model	Paint Color		
Wall Rail <ul style="list-style-type: none"> Accommodates KI paper management accessories Sent with a second extrusion that fastens to wall Wall rail attaches to second extrusion 	24 x 3/8 x 2-1/4"	ATWR24/WM	<input type="checkbox"/>	0.5#	\$ 129
	36 x 3/8 x 2-1/4"	ATWR36/WM	<input type="checkbox"/>	1.0#	167
	48 x 3/8 x 2-1/4"	ATWR48/WM	<input type="checkbox"/>	1.0#	180
	72 x 3/8 x 2-1/4"	ATWR72/WM	<input type="checkbox"/>	1.5#	255
	96 x 3/8 x 2-1/4"	ATWR96/WM	<input type="checkbox"/>	2.0#	264
			<input type="checkbox"/>		



ATAC

A

B

HOW TO ORDER

Indicate the following information on order form:

- Quantity of each item.
- Model number, including options. See "How To Build a Model Number".
- Any special service required.

Note: • The indicates that a choice is required.

- The absence of the indicates that no choice is required.
- Alpha-numeric characters in place of indicate that no other alternatives are available.

HOW TO BUILD A MODEL NUMBER

- A** Select basic model.
- B** Select paint color. Refer to the **Product Color Options** page in this price list.

FINISH INFORMATION

Additional Paint Colors

Other paint colors are available with additional lead time. Contact KI.

SPECIAL SERVICES

Special Carton Marking

With specially marked information N/C

Shipping

Ships **assembled, FOB Pembroke, ON K8A 0E1, freight prepaid.** Freight class 70.

Specifications and prices are subject to change without prior notice.

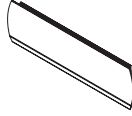
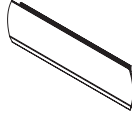
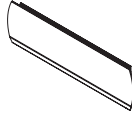

MODEL	W x D x H	MODEL NUMBER		Approx. Packaged Weight	Delivered Pricing
		Basic Model	Paint Color		
 <p>Panel Rail - WireWorks® panels bracketry (WW)</p> <ul style="list-style-type: none"> Accommodates KI paper management accessories Includes system furniture bracketry Can be hung off-module; rail must be wider than panel 	24 x 3/8 x 2-1/4"	ATWR24/WW	<input type="checkbox"/>	0.5#	\$ 119
	36 x 3/8 x 2-1/4"	ATWR36/WW	<input type="checkbox"/>	1.0#	154
	48 x 3/8 x 2-1/4"	ATWR48/WW	<input type="checkbox"/>	1.0#	159
	72 x 3/8 x 2-1/4"	ATWR72/WW	<input type="checkbox"/>	1.5#	220
	96 x 3/8 x 2-1/4"	ATWR96/WW	<input type="checkbox"/>	2.0#	234
ATAC					
 <p>Panel Rail - System 3000® panels bracketry (S3)</p> <ul style="list-style-type: none"> Accommodates KI paper management accessories Includes system furniture bracketry Can be hung off-module; rail must be wider than panel 	24 x 3/8 x 2-1/4"	ATWR24/S3	<input type="checkbox"/>	0.5#	\$ 119
	36 x 3/8 x 2-1/4"	ATWR36/S3	<input type="checkbox"/>	1.0#	154
	48 x 3/8 x 2-1/4"	ATWR48/S3	<input type="checkbox"/>	1.0#	159
	72 x 3/8 x 2-1/4"	ATWR72/S3	<input type="checkbox"/>	1.5#	220
	96 x 3/8 x 2-1/4"	ATWR96/S3	<input type="checkbox"/>	2.0#	234
ATAC					
 <p>Panel Rail - Genius® movable wall bracketry (GW)</p> <ul style="list-style-type: none"> Accommodates KI paper management accessories Includes system furniture bracketry Can be hung off-module; rail must be wider than panel 	24 x 3/8 x 2-1/4"	ATWR24/GW	<input type="checkbox"/>	0.5#	\$ 119
	36 x 3/8 x 2-1/4"	ATWR36/GW	<input type="checkbox"/>	1.0#	154
	48 x 3/8 x 2-1/4"	ATWR48/GW	<input type="checkbox"/>	1.0#	159
	72 x 3/8 x 2-1/4"	ATWR72/GW	<input type="checkbox"/>	1.5#	220
	96 x 3/8 x 2-1/4"	ATWR96/GW	<input type="checkbox"/>	2.0#	234
ATAC					

A

B

HOW TO ORDER

- Indicate the following information on order form:
- Quantity of each item.
 - Model number, including options. See "How To Build a Model Number".
 - Any special service required.

- Note:
- The indicates that a choice is required.
 - The absence of the indicates that no choice is required.
 - Alpha-numeric characters in place of indicate that no other alternatives are available.

HOW TO BUILD A MODEL NUMBER

- A** Select basic model.
- B** Select paint color.
Refer to the **Product Color Options** page in this price list.

FINISH INFORMATION

Additional Paint Colors

Other paint colors are available with additional lead time. Contact KI.

SPECIAL SERVICES

Special Carton Marking

With specially marked information N/C

Shipping

Ships **assembled, FOB Pembroke, ON K8A 0E1, freight prepaid.** Freight class 70.

Specifications and prices are subject to change without prior notice.

Worksurface Accessories

Keyboard Tray with Trackless Arm



Worksurface Accessories

Keyboard Tray with Trackless Arm

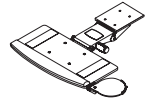
MODEL	MODEL NUMBER		Approx. Packaged Weight	Delivered Pricing	
	Basic Model				
 <p>AC204</p> <p>Keyboard Tray with Trackless Arm</p> <ul style="list-style-type: none"> Trackless arm requires only 9-3/8" mounting space under worksurface Articulating keyboard arm support Mini HDPE tray with swivel mouse tray Compliant with 5th Percentile Seated Height Range knee clearance outlined in ANSI/HFES 100-2007 Guidelines Effortless height range adjustment from -1.25 to -6.98 below the mounting surface Lift and lock height locking method Direct mounting Tilt angle of +10 to -15 degrees Dial tilt soft-touch knob with tilt and height indicator 360 degree swivel allows user to move keyboard freely from side to side Available in black 	KTTA		10.00#	\$ 480	

A

HOW TO ORDER

- Indicate the following information on order form:
- Quantity of each item.
 - Model number, including options. See "How To Build a Model Number".
 - Any special service required.

- Note:
- The indicates that a choice is required.
 - The absence of the indicates that no choice is required.
 - Alpha-numeric characters in place of indicate that no other alternatives are available.

HOW TO BUILD A MODEL NUMBER

- A** Select basic model.

SPECIAL SERVICES

Special Carton Marking

With specially marked information N/C

Shipping

Ships **knocked down, FOB Manitowoc, WI 54220, freight prepaid.** Freight class 70.

Specifications and prices are subject to change without prior notice.

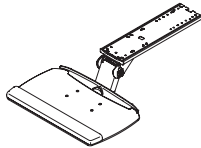

MODEL	W x D	MODEL NUMBER		Approx. Packaged Weight	Delivered Pricing		
		Basic Model					
 <p>AC203</p> <p>Keyboard Tray for Corner Worksurfaces without Mouse Tray</p> <ul style="list-style-type: none"> Ergonomically shaped, low-profile ABS plastic keyboard tray features anti-skid grip strips Snap in foam-gel wrist rest is easy to clean and wear resistant 23.0" glide track requires 24" deep clearance under worksurface Low profile arm design provides maximum leg room Patented lift-and-lock spring-assisted counterbalancing system allows for precise height adjustment (up 3.0" and down 7.75") without use of knobs or levers Fully adjustable 7.5" extended length neck accommodates corner mounts 360° swivel allows user to move keyboard freely from side to side Soft touch knob provides tilt control +/-15 degrees Available in black only 	23 x 12.3"	KOMG.23		17.00#	\$ 512		

A

HOW TO ORDER

- Indicate the following information on order form:
- Quantity of each item.
 - Model number, including options. See "How To Build a Model Number".
 - Any special service required.

Note:

- The indicates that a choice is required.
- The absence of the indicates that no choice is required.
- Alpha-numeric characters in place of indicate that no other alternatives are available.

HOW TO BUILD A MODEL NUMBER

A Select basic model.

SPECIAL SERVICES

Special Carton Marking

With specially marked information N/C

Shipping

Ships **knocked down, FOB Manitowoc, WI 54220, freight prepaid.** Freight class 70.

Specifications and prices are subject to change without prior notice.

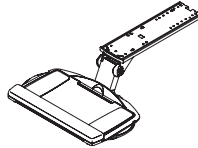

MODEL	W x D	MODEL NUMBER		Approx. Packaged Weight	Delivered Pricing	
		Basic Model				
 <p>AC203</p> <p>Keyboard Tray for Corner Worksurfaces with Mouse Tray</p> <ul style="list-style-type: none"> Sliding mouse surface has three forward index positions for optimal ergonomic posture Slide-through mousing surface adjusts easily from side to side for left or right hand usage; mouse tray does not tilt Ergonomically shaped, low-profile ABS plastic keyboard tray features anti-skid grip strips, built-in cable manager and fence Snap in foam-gel wrist rest is easy to clean and wear resistant 23.0" glide track requires 24" deep clearance under worksurface Low profile arm design provides maximum leg room Patented lift-and-lock spring-assisted counterbalancing system allows for precise height adjustment (up 3.0" and down 7.75") without use of knobs or levers Fully adjustable 7.5" extended length neck accommodates corner mounts 360° swivel allows user to move keyboard freely from side to side Soft touch knob provides tilt control +/-15 degrees Available in black only 	23 x 12.3"	KOMG.23.M		17.00#	\$ 601	

A

HOW TO ORDER

- Indicate the following information on order form:
- Quantity of each item.
 - Model number, including options. See "How To Build a Model Number".
 - Any special service required.

Note:

- The indicates that a choice is required.
- The absence of the indicates that no choice is required.
- Alpha-numeric characters in place of indicate that no other alternatives are available.

HOW TO BUILD A MODEL NUMBER

A Select basic model.

SPECIAL SERVICES

Special Carton Marking

With specially marked information N/C

Shipping

Ships **knocked down, FOB Manitowoc, WI 54220, freight prepaid.** Freight class 70.

Specifications and prices are subject to change without prior notice.

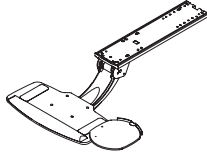

MODEL	W x D	MODEL NUMBER		Approx. Packaged Weight	Delivered Pricing	
		Basic Model				
 <p>AC203</p> <p>Keyboard Tray for Corner Worksurfaces with Tilt and Swivel Mouse Tray</p> <ul style="list-style-type: none"> Ergonomically shaped, rigid phenolic tray is sturdier than steel, and offers anti-skid grip strips Built-in mouse guard with cable management prevents mouse from slipping off tray Height adjustable mousing surface can be mounted via a simple clamp or direct mounted with a screw & nut Swivel and tilt mouse tray attaches right or left Snap in foam-gel wrist rest is easy to clean and wear resistant 23.0" glide track requires 24" deep clearance under worksurface Low profile arm design provides maximum leg room Patented lift-and-lock spring-assisted counterbalancing system allows for precise height adjustment (up 3.0" and down 7.75") without use of knobs or levers Fully adjustable 7.5" extended length neck accommodates corner mounts 360° swivel allows user to move keyboard freely from side to side Soft touch knob provides tilt control +/-15 degrees Available in graphite tray and black arm 	21 x 13"	KOMG.23.PM		18.00#	\$ 865	

A

HOW TO ORDER

- Indicate the following information on order form:
- Quantity of each item.
 - Model number, including options. See "How To Build a Model Number".
 - Any special service required.

- Note:
- The indicates that a choice is required.
 - The absence of the indicates that no choice is required.
 - Alpha-numeric characters in place of indicate that no other alternatives are available.

HOW TO BUILD A MODEL NUMBER

- A** Select basic model.

SPECIAL SERVICES

Special Carton Marking

With specially marked information N/C

Shipping

Ships **knocked down, FOB Manitowoc, WI 54220, freight prepaid.** Freight class 70.

Specifications and prices are subject to change without prior notice.

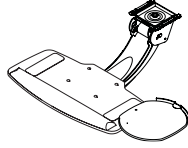

MODEL	W x D	MODEL NUMBER		Approx. Packaged Weight	Delivered Pricing	
		Basic Model				
 <p>AC203</p> <p>Keyboard Tray for Corner Surface-Sit-to-Stand Tilt & Swivel Mouse Tray</p> <ul style="list-style-type: none"> Ergonomically shaped, rigid phenolic tray is sturdier than steel, and offers anti-skid grip strips Built-in mouse guard with cable management prevents mouse from slipping off tray Adjustable and detachable swivel and tilt mouse tray attaches right or left Snap in foam-gel wrist rest is easy to clean and wear resistant 23.0" glide track requires 24" deep clearance under worksurface Low profile arm design provides maximum leg room Sit-to stand spring-assisted counterbalancing system allows for precise height adjustment (up 8.25" and down 6.0") without use of knobs or levers 360° swivel allows user to move keyboard freely from side to side Soft touch knob provides tilt control +/-15 degrees Available in graphite tray and black arm 	21 x 13"	KOMSG.23.PM		18.00#	\$ 1055	

A

HOW TO ORDER

- Indicate the following information on order form:
- Quantity of each item.
 - Model number, including options. See "How To Build a Model Number".
 - Any special service required.

Note:

- The indicates that a choice is required.
- The absence of the indicates that no choice is required.
- Alpha-numeric characters in place of indicate that no other alternatives are available.

HOW TO BUILD A MODEL NUMBER

A Select basic model.

SPECIAL SERVICES

Special Carton Marking

With specially marked information N/C

Shipping

Ships **knocked down, FOB Manitowoc, WI 54220, freight prepaid.** Freight class 70.

Specifications and prices are subject to change without prior notice.

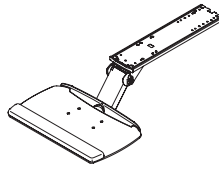

MODEL	W x D	MODEL NUMBER		Approx. Packaged Weight	Delivered Pricing		
		Basic Model					
 <p>AC203</p> <p>Keyboard Tray for Rectangular Worksurfaces without Mouse Tray</p> <ul style="list-style-type: none"> Ergonomically shaped, low-profile ABS plastic keyboard tray features anti-skid grip strips Snap in foam-gel wrist rest is easy to clean and wear resistant 20" glide track requires 21" deep clearance under worksurface Low profile arm design provides maximum leg room Patented lift-and-lock spring-assisted counterbalancing system allows for precise height adjustment (up 2.5" and down 5.8") without use of knobs or levers Fully adjustable 5.5" standard length neck accommodates straight desktops with limited space 360° swivel allows user to move keyboard freely from side to side Soft touch knob provides tilt control +/-15 degrees Available in black only 	23 x 12.3"	KOMG.20		15.00#	\$ 602		

A

HOW TO ORDER

- Indicate the following information on order form:
- Quantity of each item.
 - Model number, including options. See "How To Build a Model Number".
 - Any special service required.

Note:

- The indicates that a choice is required.
- The absence of the indicates that no choice is required.
- Alpha-numeric characters in place of indicate that no other alternatives are available.

HOW TO BUILD A MODEL NUMBER

A Select basic model.

SPECIAL SERVICES

Special Carton Marking

With specially marked information N/C

Shipping

Ships **assembled, FOB Pembroke, ON K8A 0E1, freight prepaid.** Freight class 70.

Specifications and prices are subject to change without prior notice.

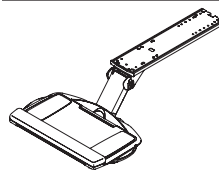

MODEL	W x D	MODEL NUMBER		Approx. Packaged Weight	Delivered Pricing		
		Basic Model					
 <p>AC203</p> <p>Keyboard Tray for Rectangular Worksurfaces with Mouse Tray</p> <ul style="list-style-type: none"> Sliding mouse surface has three forward index positions for optimal ergonomic posture Slide-through mousing surface adjusts easily from side to side for left or right hand usage Ergonomically shaped, stable, low-profile ABS plastic keyboard tray features antiskid grip strips, built-in cable manager and fence Snap in foam-gel wrist rest is easy to clean and wear resistant 20" glide track requires 21" deep clearance under worksurface Low profile arm design provides maximum leg room Patented lift-and-lock spring-assisted counterbalancing system allows for precise height adjustment (up 2.5" and down 5.8") without use of knobs or levers Fully adjustable 5.5" standard length neck accommodates straight desktops with limited space 360° swivel allows user to move keyboard freely from side to side Soft touch knob provides tilt control +/-15 degrees Available in black only 	23 x 12.3"	KOMG.20.M		15.00#	\$ 690		

A

HOW TO ORDER

- Indicate the following information on order form:
- Quantity of each item.
 - Model number, including options. See "How To Build a Model Number".
 - Any special service required.

Note:

- The indicates that a choice is required.
- The absence of the indicates that no choice is required.
- Alpha-numeric characters in place of indicate that no other alternatives are available.

HOW TO BUILD A MODEL NUMBER

A Select basic model.

SPECIAL SERVICES

Special Carton Marking

With specially marked information N/C

Shipping

Ships **assembled, FOB Pembroke, ON K8A 0E1, freight prepaid.** Freight class 70.

Specifications and prices are subject to change without prior notice.

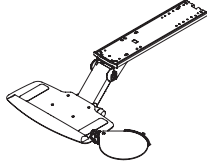

MODEL	W x D	MODEL NUMBER		Approx. Packaged Weight	Delivered Pricing	
		Basic Model				
 <p>AC203</p> <p>Keyboard Tray for Rectangular Worksurfaces with Tilt Mouse Tray</p> <ul style="list-style-type: none"> Ergonomically shaped, rigid phenolic tray is sturdier than steel, and offers anti-skid grip strips Built-in mouse guard with cable management prevents mouse from slipping off tray Height adjustable mousing surface can be mounted via a simple clamp or direct mounted with a screw & nut Swivel and tilt mouse tray attaches right or left Snap in foam-gel wrist rest is easy to clean and wear resistant 20" glide track requires 21" deep clearance under worksurface Low profile arm design provides maximum leg room Patented lift-and-lock spring-assisted counterbalancing system allows for precise height adjustment (up 2.5" and down 5.8") without use of knobs or levers Fully adjustable 5.5" standard length neck accommodates straight desktops with limited space 360° swivel allows user to move keyboard freely from side to side Soft touch knob provides tilt control +/-15 degrees Available in graphite tray and black arm 	21 x 13"	KOMG.20.PM		16.00#	\$ 930	

A

HOW TO ORDER

- Indicate the following information on order form:
- Quantity of each item.
 - Model number, including options. See "How To Build a Model Number".
 - Any special service required.

Note:

- The indicates that a choice is required.
- The absence of the indicates that no choice is required.
- Alpha-numeric characters in place of indicate that no other alternatives are available.

HOW TO BUILD A MODEL NUMBER

A Select basic model.

SPECIAL SERVICES

Special Carton Marking

With specially marked information N/C

Shipping

Ships **assembled, FOB Pembroke, ON K8A 0E1, freight prepaid.** Freight class 70.

Specifications and prices are subject to change without prior notice.

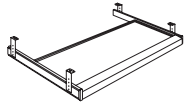
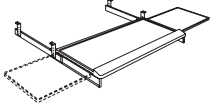

	MODEL	W x D	MODEL NUMBER		Approx. Packaged Weight	Delivered Pricing
			Basic Model			
 AC203	Sliding Keyboard Drawer <ul style="list-style-type: none"> Sliding drawer mounts under worksurface 12" telescoping slides Standard with molded palm rest Cannot be used on 24" deep corner units Available in black only 	20-7/8 x 10-1/2"	KBD.24.BL		9.00#	\$ 297
 AC203	Sliding Keyboard Drawer w/Mouse Tray <ul style="list-style-type: none"> Sliding keyboard drawer with non-handed sliding mousing surface Standard with molded palm rest 24" has 12" telescoping slides 30" has 16" telescoping slides Cannot be used on 24" deep corner units Available in black only 	20-7/8 x 10-1/2"	KBDM.30.BL		10.00#	\$ 372

A

HOW TO ORDER

Indicate the following information on order form:

- Quantity of each item.
- Model number, including options. See "How To Build a Model Number".
- Any special service required.

Note: • The indicates that a choice is required.

- The absence of the indicates that no choice is required.
- Alpha-numeric characters in place of indicate that no other alternatives are available.

HOW TO BUILD A MODEL NUMBER

- A** Select basic model.

SPECIAL SERVICES

Special Carton Marking

With specially marked information N/C

Shipping

Ships **assembled, FOB Pembroke, ON K8A 0E1, freight prepaid.** Freight class 70.

Specifications and prices are subject to change without prior notice.

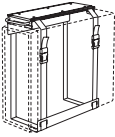

MODEL	W x D	MODEL NUMBER		Approx. Packaged Weight	Delivered Pricing
		Basic Model			
 <p>CPU Sling</p> <ul style="list-style-type: none"> Vertically supports and stores CPU below the worksurface Straps have positive locking clamps Provides 5-1/2" of travel and 359° swivel Maximum weight capacity is 75 lbs. Available in black only Recommended for 30" deep worksurfaces Accommodates CPU with maximum CPU perimeter of 65" 	5-3/8 x 18"	CPU.SLING		10.00#	\$ 265

AC202

A

HOW TO ORDER

- Indicate the following information on order form:
- Quantity of each item.
 - Model number, including options. See "How To Build a Model Number".
 - Any special service required.

- Note:
- The indicates that a choice is required.
 - The absence of the indicates that no choice is required.
 - Alpha-numeric characters in place of indicate that no other alternatives are available.

HOW TO BUILD A MODEL NUMBER

- A** Select basic model.

SPECIAL SERVICES

Special Carton Marking

With specially marked information N/C

Shipping

Ships **knocked down, FOB Bonduel, WI 54107, freight prepaid.** Freight class 70.

Specifications and prices are subject to change without prior notice.

Worksurface Accessories

Adjustable/Securable CPU Holder



Worksurface Accessories

Adjustable/Securable CPU Holder

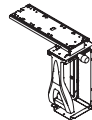
MODEL	MODEL NUMBER	Approx. Packaged Weight	Delivered Pricing	
	Basic Model			
 AC201 CPU Holder, No Lock <ul style="list-style-type: none"> Slide mechanism 17" forward slide Vertical 13-1/2" to 22-1/2" Horizontal (side-to-side) 3-1/2" to 9" No more than 85 lbs Black only Check under surface clearances before ordering 	KOCPUS	13.00#	\$ 376	
AC201	CPU Holder with Lock <ul style="list-style-type: none"> Integrated lock within the handle Black only 	KOCPUL	14.00#	\$ 509

A

HOW TO ORDER

Indicate the following information on order form:

- Quantity of each item.
- Model number, including options. See "How To Build a Model Number".
- Any special service required.

Note: • The indicates that a choice is required.

- The absence of the indicates that no choice is required.
- Alpha-numeric characters in place of indicate that no other alternatives are available.

HOW TO BUILD A MODEL NUMBER

A Select basic model.

SPECIAL SERVICES

Special Carton Marking

With specially marked information N/C

Shipping

Ships **knocked down, FOB Bonduel, WI 54107, freight prepaid**. Freight class 70.

Specifications and prices are subject to change without prior notice.

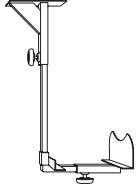

MODEL	MODEL NUMBER	Approx. Packaged Weight	Delivered Pricing
	Basic Model		
 <p>AC201</p> <p>Compact CPU Holder</p> <ul style="list-style-type: none"> Vertically or horizontally supports and stores CPU below the worksurface Available in black only Holder in the vertical position accommodates CPU's 5.5 to 9.8 inches wide and 15.5 to 20 inches tall Holder in the horizontal position accommodates CPU's 13.8 to 18.8 inches wide and 7.3 to 11.3 inches tall Can hold up to 70-80 lbs in the vertical position Can hold up to 30 lbs in the horizontal position Mounting plate overall dimensions 5.38" x 3.95" 	KOCPUE	7.00#	\$ 107

A

HOW TO ORDER

- Indicate the following information on order form:
- Quantity of each item.
 - Model number, including options. See "How To Build a Model Number".
 - Any special service required.

Note:

- The indicates that a choice is required.
- The absence of the indicates that no choice is required.
- Alpha-numeric characters in place of indicate that no other alternatives are available.

HOW TO BUILD A MODEL NUMBER

A Select basic model.

SPECIAL SERVICES

Special Carton Marking

With specially marked information N/C

Shipping

Ships **knocked down, FOB Bonduel, WI 54107, freight prepaid.** Freight class 70.

Specifications and prices are subject to change without prior notice.

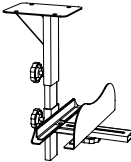

MODEL	MODEL NUMBER	Approx. Packaged Weight	Delivered Pricing
	Basic Model		
 <p>Mini CPU Holder</p> <ul style="list-style-type: none"> • Mounts under the work surface • Adjustable height and width • Vertical 7.2" to 16" • Horizontal (side-to-side) 1.2" to 6" • Black only 	KOCPUM	7.00#	\$ 83

AC201

A

HOW TO ORDER

- Indicate the following information on order form:
1. Quantity of each item.
 2. Model number, including options. See "How To Build a Model Number".
 3. Any special service required.

- Note:
- The indicates that a choice is required.
 - The absence of the indicates that no choice is required.
 - Alpha-numeric characters in place of indicate that no other alternatives are available.

HOW TO BUILD A MODEL NUMBER

- A** Select basic model.

SPECIAL SERVICES

Special Carton Marking

With specially marked information N/C

Shipping

Ships **knocked down, FOB Bonduel, WI 54107, freight prepaid.** Freight class 70.

Specifications and prices are subject to change without prior notice.

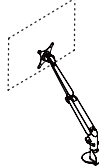

MODEL	Features	MODEL NUMBER		Approx. Packaged Weight	Delivered Pricing
		Basic Model			
 <p>AC200</p> <p>Extended Arm for 1-15 lb. Monitors</p> <ul style="list-style-type: none"> • Arm extends up to 19.6" from the base • Vertical range of motion is 9.2-19.6" high from the center of the bracket • Holds 1-15 lb monitors • Horizontal range of motion is 3.8-18.0" • After installation monitor can be rotated to either portrait or landscape • 75/100 VESA compliant • 180 degree rotation on the base • 90 degree monitor pivot • CM option comes with a standard clamp mount/grommet kit • Finish is silver • Clamp mount (CM) requires 2-3/4" of under worksurface clearance, consult the assembly instructions for alternative mounting options 	Clamp Mount	K.61092.SL.CM	9.00#	\$ 769	

A

HOW TO ORDER

- Indicate the following information on order form:
1. Quantity of each item.
 2. Model number, including options. See "How To Build a Model Number".
 3. Any special service required.

Note:

- The indicates that a choice is required.
- The absence of the indicates that no choice is required.
- Alpha-numeric characters in place of indicate that no other alternatives are available.

HOW TO BUILD A MODEL NUMBER

A Select basic model.

SPECIAL SERVICES

Special Carton Marking

With specially marked information N/C

Shipping

Ships **assembled, FOB Manitowoc, WI 54220, freight prepaid.** Freight class 70.

Specifications and prices are subject to change without prior notice.

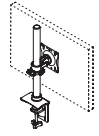
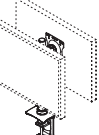

MODEL	Features	MODEL NUMBER		Approx. Packaged Weight	Delivered Pricing
		Basic Model			
 <p>AC200</p>	<p>12" Post, Single Screen</p> <ul style="list-style-type: none"> 12" post with table-edge mount or grommet mount Swivel/tilt adapter plate for 75 & 100mm hole patterns Plate attaches to monitor Supports one 14 lb. flat screen monitor Can be used on both freestanding tables and panel-mounted worksurfaces 360° swivel movement allows monitor to rotate from landscape to portrait orientation Pole allows manual height adjustment through a 9" range to accommodate user preference Includes parts for either clamp or grommet mount Monitor is not included 	Silver finish	CFS01.SL	6.00#	\$ 259
		White finish	CFS01.WH	6.00#	259
		Black finish	CFS01.BL	6.00#	259
 <p>AC200</p>	<p>12" Post, Dual Screen</p> <ul style="list-style-type: none"> 12" post with table-edge mount or grommet mount Swivel/tilt adapter plate for 75 & 100mm hole patterns Supports two 14 lb. flat screen monitors back-to-back Can be used on both freestanding tables and panel-mounted worksurfaces 360° swivel movement allows monitor to rotate from landscape to portrait orientation Pole allows manual height adjustment through a 9" range to accommodate user preference Includes parts for either clamp or grommet mount Monitors are not included 	Silver finish	CFS02.SL	8.00#	\$ 495
		White finish	CFS02.WH	8.00#	495
		Black finish	CFS02.BL	8.00#	495

A

HOW TO ORDER

- Indicate the following information on order form:
- Quantity of each item.
 - Model number, including options. See "How To Build a Model Number".
 - Any special service required.

Note:

- The indicates that a choice is required.
- The absence of the indicates that no choice is required.
- Alpha-numeric characters in place of indicate that no other alternatives are available.

HOW TO BUILD A MODEL NUMBER

A Select basic model.

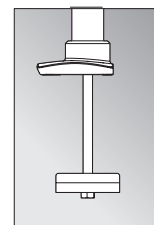

Grommet Mount

The grommet mount is required for use on the following products: DataLink®, InTandem®, WorkZone®, True® and 700 Series® Desk. Grommet Mount requires a 3/8" to 3-1/2" dia. hole for worksurfaces up to 2-1/2" thick drilled in surface on location or through a KI Product Modification Request (specify location).

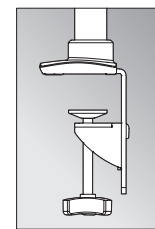

Table-edge Mount

The table edge mount CANNOT be used on the following products: DataLink®, InTandem®, WorkZone®, True® and 700 Series® Desk. The table edge mount attaches on worksurfaces up to 2-1/2" thick. The lower portion of the clamp can be removed allowing the bracket to be inserted between the worksurface and panel without removing the worksurface.

SPECIFICATIONS

- Tilt +1/-90°
- Swivel +1/-180
- Rotation +/-180
- Worksurface Range 0-3.5" for table edge mount
- Material - Steel and aluminum

Warranty - These products are warranted as follows: Lifetime
 Monitor - These products are not included.

SPECIAL SERVICES

Special Carton Marking

With specially marked information N/C

Shipping

Ships assembled, FOB Manitowoc, WI 54220, freight prepaid. Freight class 70.

Specifications and prices are subject to change without prior notice.

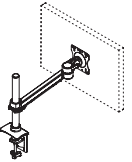
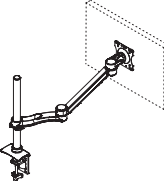
MODEL	Features	MODEL NUMBER		Approx. Packaged Weight	Delivered Pricing
		Basic Model			
 AC200	12" Post, Single Screen, 10" Arm <ul style="list-style-type: none"> 12" post with table-edge mount or grommet mount 10" arm with one wire management clip 10" arm has integrated wire management channel and cover Swivel/tilt adapter plate for 75 & 100mm hole patterns Supports one 14 lb. flat screen monitor Can be used on both freestanding tables and panel-mounted worksurfaces 360° swivel movement allows monitor to rotate from landscape to portrait orientation Pole allows manual height adjustment through a 9" range to accommodate user preference Includes parts for either clamp or grommet mount Monitor is not included 	Silver finish	CFS03.SL	7.00#	\$ 331
		White finish	CFS03.WH	7.00#	331
		Black finish	CFS03.BL	7.00#	331
 AC200	12" Post, Single Screen, Height-Adjustable Double Extension Arm <ul style="list-style-type: none"> 12" post with table-edge mount or grommet mount One 10" arm and one 9" arm with two wire management clips 10" arm has integrated wire management channel and cover Swivel/tilt adapter plate for 75 & 100mm hole patterns Supports one 14 lb. flat screen monitor Can be used on both freestanding tables and panel-mounted worksurfaces 360° swivel movement allows monitor to rotate from landscape to portrait orientation Pole allows manual height adjustment through a 9" range to accommodate user preference Includes parts for either clamp or grommet mount Monitor is not included 24" of forward/backward movement Arm folds back to post to maximize desk space 	Black finish	CFS04.BL	9.00#	\$ 403
		Silver finish	CFS04.SL	9.00#	403
		White finish	CFS04.WH	9.00#	403

HOW TO ORDER

- Indicate the following information on order form:
- Quantity of each item.
 - Model number, including options. See "How To Build a Model Number".
 - Any special service required.

- Note:
- The indicates that a choice is required.
 - The absence of the indicates that no choice is required.
 - Alpha-numeric characters in place of indicate that no other alternatives are available.

HOW TO BUILD A MODEL NUMBER

- A** Select basic model.

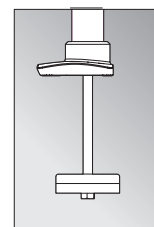

Grommet Mount

The grommet mount is required for use on the following products: DataLink®, InTandem®, WorkZone®, True® and 700 Series® Desk. Grommet Mount requires a 3/8" to 3-1/2" dia. hole for worksurfaces up to 2-1/2" thick drilled in surface on location or through a KI Product Modification Request (specify location).

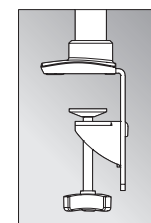

Table-edge Mount

The table edge mount CANNOT be used on the following products: DataLink®, InTandem®, WorkZone®, True® and 700 Series® Desk. The table edge mount attaches on worksurfaces up to 2-1/2" thick. The lower portion of the clamp can be removed allowing the bracket to be inserted between the worksurface and panel without removing the worksurface.

SPECIFICATIONS

Tilt +1/-90°
 Swivel +1/-180
 Rotation +/-180
 Worksurface Range 0-3.5" for table edge mount
 Material - Steel and aluminum

Warranty - These products are warranted as follows: Lifetime
 Monitor - These products are not included.

SPECIAL SERVICES

Special Carton Marking

With specially marked information N/C

Shipping

Ships assembled, FOB Manitowoc, WI 54220, freight prepaid. Freight class 70.

Specifications and prices are subject to change without prior notice.



MODEL	Features	MODEL NUMBER		Approx. Packaged Weight	Delivered Pricing
		Basic Model			
12" Post, Dual Screen, Two 10" Arms • 12" post with table-edge mount or grommet mount • Two 10" arms with two wire management clips • Arms have integrated wire management channel and cover • Two swivel/tilt adapter plates for 75 & 100mm hole patterns • Supports two 20 lb. flat screen monitors with a maximum width of 23.7" per screen • Can be used on both freestanding tables and panel-mounted worksurfaces • 360° swivel movement allows monitor to rotate from landscape to portrait orientation • Pole allows manual height adjustment through a 11" range to accommodate user preference • Includes parts for either clamp or grommet mount • Monitors are not included • Monitors adjust in unison to maintain a level plane and provide consistent vision line	Black finish	CFS05.BL	10.00#	\$ 633	
	Silver finish	CFS05.SL	10.00#	633	
	White finish	CFS05.WH	10.00#	633	

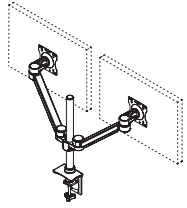

AC200

A

HOW TO ORDER

- Indicate the following information on order form:
- Quantity of each item.
 - Model number, including options. See "How To Build a Model Number".
 - Any special service required.

- Note:
- The indicates that a choice is required.
 - The absence of the indicates that no choice is required.
 - Alpha-numeric characters in place of indicate that no other alternatives are available.

HOW TO BUILD A MODEL NUMBER

- A** Select basic model.

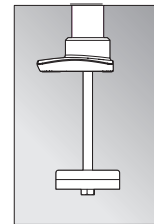

Grommet Mount

The grommet mount is required for use on the following products: DataLink®, InTandem®, WorkZone®, True® and 700 Series® Desk. Grommet Mount requires a 3/8" to 3-1/2" dia. hole for worksurfaces up to 2-1/2" thick drilled in surface on location or through a KI Product Modification Request (specify location).

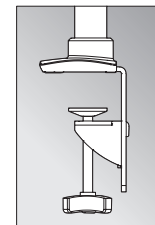

Table-edge Mount

The table edge mount CANNOT be used on the following products: DataLink®, InTandem®, WorkZone®, True® and 700 Series® Desk. The table edge mount attaches on worksurfaces up to 2-1/2" thick. The lower portion of the clamp can be removed allowing the bracket to be inserted between the worksurface and panel without removing the worksurface.

SPECIFICATIONS

- Tilt +1/-90°
- Swivel +1/-180
- Rotation +/-180
- Worksurface Range 0-3.5" for table edge mount
- Material - Steel and aluminum

Warranty - These products are warranted as follows: Lifetime
 Monitor - These products are not included.

SPECIAL SERVICES

Special Carton Marking

With specially marked information N/C

Shipping

Ships assembled, FOB Manitowoc, WI 54220, freight prepaid. Freight class 70.

Specifications and prices are subject to change without prior notice.



MODEL	Features	MODEL NUMBER		Approx. Packaged Weight	Delivered Pricing
		Basic Model			
12" Post, Dual Screen, Two Double Extension Arms • 12" post with table-edge mount or grommet mount • Two 10" arms and two 9" arms (one 10" and one 9" arm per monitor) with four wire management clips • 10" arms have integrated wire management channel and cover • Two swivel/tilt adapter plates for 75 & 100mm hole patterns • Each extended arm supports one 14 lb. flat screen monitor • Maximum monitor size is 36" • Can be used on both freestanding tables and panel-mounted worksurfaces • 360° swivel movement allows monitor to rotate from landscape to portrait orientation • Pole allows manual height adjustment through a 9" range to accommodate user preference • Includes parts for either clamp or grommet mount • Monitors are not included • 24" of forward/backward movement • Arm folds back to post to maximize desk space • Monitors adjust in unison to maintain a level plane and provide consistent vision line	Black finish	CFS06.BL		11.00#	\$ 787
	Silver finish	CFS06.SL		11.00#	787
	White finish	CFS06.WH		11.00#	787

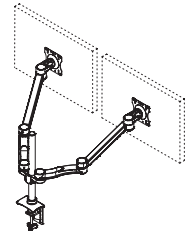

AC200

A

HOW TO ORDER

- Indicate the following information on order form:
- Quantity of each item.
 - Model number, including options. See "How To Build a Model Number".
 - Any special service required.

Note:

- The indicates that a choice is required.
- The absence of the indicates that no choice is required.
- Alpha-numeric characters in place of indicate that no other alternatives are available.

HOW TO BUILD A MODEL NUMBER

A Select basic model.

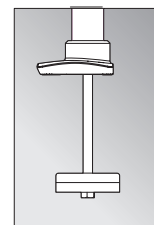

Grommet Mount

The grommet mount is required for use on the following products: DataLink®, InTandem®, WorkZone®, True® and 700 Series® Desk. Grommet Mount requires a 3/8" to 3-1/2" dia. hole for worksurfaces up to 2-1/2" thick drilled in surface on location or through a KI Product Modification Request (specify location).

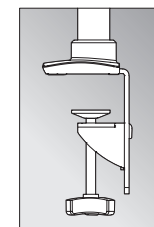

Table-edge Mount

The table edge mount CANNOT be used on the following products: DataLink®, InTandem®, WorkZone®, True® and 700 Series® Desk. The table edge mount attaches on worksurfaces up to 2-1/2" thick. The lower portion of the clamp can be removed allowing the bracket to be inserted between the worksurface and panel without removing the worksurface.

SPECIFICATIONS

- Tilt +1/-90°
- Swivel +1/-180
- Rotation +/-180
- Worksurface Range 0-3.5" for table edge mount
- Material - Steel and aluminum

Warranty - These products are warranted as follows: Lifetime
 Monitor - These products are not included.

SPECIAL SERVICES

Special Carton Marking

With specially marked information N/C

Shipping

Ships **assembled, FOB Manitowoc, WI 54220, freight prepaid.** Freight class 70.

Specifications and prices are subject to change without prior notice.



MODEL	Features	MODEL NUMBER		Approx. Packaged Weight	Delivered Pricing
		Basic Model			
16" Post, Triple Screen • 16" post with table-edge mount or grommet mount • Features two 8" arms outer arms attached to a 22" horizontal support beam • All monitors' heights adjust in unison • Supports monitors with a maximum horizontal dimension of 18" • Three swivel/tile adapter plates for 75 & 100mm hole patterns • Each adapter plate supports one 14 lb. flat screen monitor • Can be used on both freestanding tables and panel mounted work surfaces • 360° swivel movement allows monitors to rotate from landscape to portrait orientation • Pole allows manual height adjustment through 9" range to accommodate user preference • Includes parts for either clamp or grommet mount • Wire manager included • Monitors are not included	Silver finish	CFS07.SL		13.00#	\$ 919
	Black finish	CFS07.BL		13.00#	919

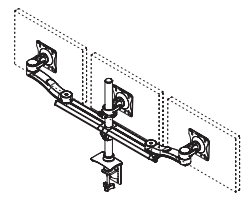

AC200

A

HOW TO ORDER

- Indicate the following information on order form:
- Quantity of each item.
 - Model number, including options. See "How To Build a Model Number".
 - Any special service required.

Note:

- The indicates that a choice is required.
- The absence of the indicates that no choice is required.
- Alpha-numeric characters in place of indicate that no other alternatives are available.

HOW TO BUILD A MODEL NUMBER

A Select basic model.

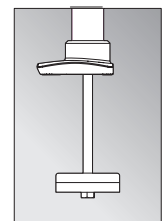

Grommet Mount

The grommet mount is required for use on the following products: DataLink®, InTandem®, WorkZone®, True® and 700 Series® Desk. Grommet Mount requires a 3/8" to 3-1/2" dia. hole for worksurfaces up to 2-1/2" thick drilled in surface on location or through a KI Product Modification Request (specify location).

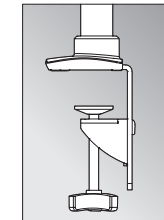

Table-edge Mount

The table edge mount CANNOT be used on the following products: DataLink®, InTandem®, WorkZone®, True® and 700 Series® Desk. The table edge mount attaches on worksurfaces up to 2-1/2" thick. The lower portion of the clamp can be removed allowing the bracket to be inserted between the worksurface and panel without removing the worksurface.

SPECIFICATIONS

- Tilt +1/-90°
- Swivel +1/-180
- Rotation +/-180
- Worksurface Range 0-3.5" for table edge mount
- Material - Steel and aluminum

Warranty - These products are warranted as follows: Lifetime
 Monitor - These products are not included.

SPECIAL SERVICES

Special Carton Marking

With specially marked information N/C

Shipping

Ships assembled, FOB Manitowoc, WI 54220, freight prepaid. Freight class 70.

Specifications and prices are subject to change without prior notice.

**Ashley Duo Module Colors**

Black	BL
Warm Grey	WG
Cottonwood	TT

HDMI Connector Color

Black	BL
Cottonwood	CO

Layer Module Colors

Carbon Grey	CB
Cottonwood	CO

PowerUp Module Poly Colors

Black	BL
Blue Grey	GR
Cool Grey	CG
Flannel	FN
Misty Brown	MY
Sand	SA
Warm Grey	WG

Dean, Dubbel, Nacre, Node Power Module Color (Corded, Pattern)

Black	BL
Cool Grey	CG
Cottonwood	CO
Warm Grey	WG

Thesis Battery Power Color

Black	BL
Cool Grey	CG
Cottonwood	CO

Thesis Bracket Color

Black	BL
Cottonwood	CO

Vesta Battery Power Color**Metal Grommet Colors**

Black	BL
Blue Grey	GR
Bronze Metallic	ZM
Champagne Metallic	CM
Cool Grey	CG
Cottonwood	CO
Flannel	FN
Misty Brown	MY
Starlight Silver Metallic	SX
Warm Grey	WG

Plastic Grommet Color

Black	BL
Blue Grey	GR
Cool Grey	CG
Flannel	FN
Misty Brown	MY
Sand	SA
Warm Grey	WG

Finish Cards

View color swatches for items listed within this document.

[Paints](#)[Plastics/Poly](#)[Wood/Veneer](#)[Laminates](#)[Molded Edges](#)[Edge Styles](#)[Hard Plastics](#)[Glass](#)

Certain options referenced may not be available on GSA Schedule.

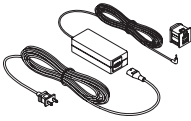

MODEL	L	MODEL NUMBER		Approx. Packaged Weight	Delivered Pricing
		Basic Model			
 <p>AC409</p> <p>Drop-in USB charger</p> <ul style="list-style-type: none"> • Available only in black • Snaps into the universal data tree ports (in place of the data) • Must be plugged into separate power source • Will work with any KI Power-Up already in the field • Cord length is 72" • 4 amps combined for both USB charging ports • Plug dimensions are 1-1/2" deep x 3-3/8" high x 1-7/8" wide 	72"	USB.CHARGE.BL	1.00#	\$ 141	

A

HOW TO ORDER

- Indicate the following information on order form:
1. Quantity of each item.
 2. Model number, including options. See "How To Build a Model Number".
 3. Any special service required.

Note:

- The indicates that a choice is required.
- The absence of the indicates that no choice is required.
- Alpha-numeric characters in place of indicate that no other alternatives are available.

HOW TO BUILD A MODEL NUMBER

A Select basic model.

SPECIAL SERVICES

Special Carton Marking

With specially marked information N/C

Shipping

Ships **assembled, FOB Bonduel, WI 54107, freight prepaid.** Freight class 85.

Specifications and prices are subject to change without prior notice.



Ashley Duo Module

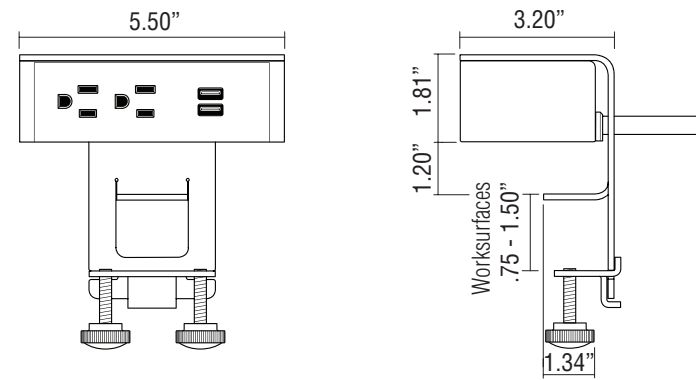

Ashley Duo Under Mount Module

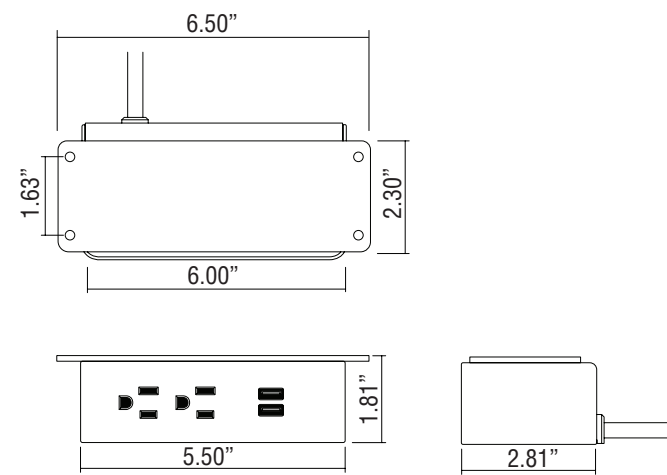

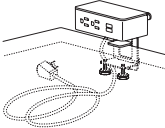

MODEL	Features	MODEL NUMBER		Approx. Packaged Weight	Delivered Pricing
		Basic Model	Module Color		
 <p>AC416</p> <p>Ashley Duo Module</p> <ul style="list-style-type: none"> Provides two 3-prong receptacles and two USB power outlets (2.1A each) Modules offer an 8' or 15' 3-prong plug power source Attach with a thin mounting bracket with thumb screws Wire management not included Fits work surfaces .75" to 1.5" in thickness 15A approved Dimensions are 5.5" x 3.2" x 4.5" 	8'	ASHDUO.8	<input type="checkbox"/>	3.00#	\$ 324
	15'	ASHDUO.15	<input type="checkbox"/>	3.70#	340

A

B

HOW TO ORDER

- Indicate the following information on order form:
- Quantity of each item.
 - Model number, including options. See "How To Build a Model Number".
 - Any special service required.

Note:

- The indicates that a choice is required.
- The absence of the indicates that no choice is required.
- Alpha-numeric characters in place of indicate that no other alternatives are available.

HOW TO BUILD A MODEL NUMBER

A Select basic model.

B Select module color.

- BL** - Black
- WG** - Warm Grey
- TT** - Cottonwood

SPECIAL SERVICES

Special Carton Marking

With specially marked information N/C

Shipping

Ships **assembled, FOB Bondue, WI 54107, freight prepaid.** Freight class 70.

Specifications and prices are subject to change without prior notice.

Accessory Power Modules

Ashley Duo™ Module



Accessory Power Modules

Ashley Duo™ Module

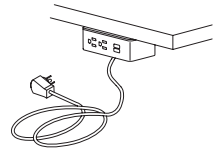
MODEL	Features	MODEL NUMBER		Approx. Packaged Weight	Delivered Pricing
		Basic Model	Module Color		
 <p>AC416</p> <p>Ashley Duo Under Module</p> <ul style="list-style-type: none"> Provides two 3-prong receptacles and two USB power outlets (2.1A each) Modules offer an 8' or 15' 3-prong plug power source Under table units attach with a thin flush mount bracket Installs in minutes Wire management not included 15A approved Dimensions are 5.5" x 2.8" x 1.8" 	8'	ASHDUO.U.8	<input type="checkbox"/>	2.00#	\$ 283
	15'	ASHDUO.U.15	<input type="checkbox"/>	2.70#	302

A

B

HOW TO ORDER

- Indicate the following information on order form:
- Quantity of each item.
 - Model number, including options. See "How To Build a Model Number".
 - Any special service required.

- Note:
- The indicates that a choice is required.
 - The absence of the indicates that no choice is required.
 - Alpha-numeric characters in place of indicate that no other alternatives are available.

HOW TO BUILD A MODEL NUMBER

A Select basic model.

B Select module color.

- BL** - Black
- TT** - Cottonwood
- WG** - Warm Grey

SPECIAL SERVICES

Special Carton Marking

With specially marked information N/C

Shipping

Ships **assembled, FOB Bonduei, WI 54107, freight prepaid.** Freight class 70.

Specifications and prices are subject to change without prior notice.

Accessory Power Modules

Layer Power Tower



Accessory Power Modules

Layer Power Tower

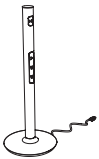
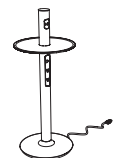
	MODEL	W x H	MODEL NUMBER		Approx. Packaged Weight	Delivered Pricing
			Basic Model	Module Color		
 LAYER	Layer Power Tower • (6) 15A, 120V tamper-resistant outlets (3 per side) • (2) USB-A charging ports • (2) USB-C 60-watt power delivery charging ports • 9 ft power cord • Includes tether and anchor slots for security (tether and anchor are customer provided) • Built-in cord management in the base	14.5 x 38"	LAYN	<input type="checkbox"/>	29.4#	\$ 2544
 LAYER	Layer Power Tower with Ledge • Includes 15.5" diameter felt-lined shelf that attaches to the Layer Tower • (6) 15A, 120V tamper-resistant outlets (3 per side) • (2) USB-A charging ports • (2) USB-C 60-watt power delivery charging ports • 9 ft power cord • Includes tether and anchor slots for security (tether and anchor are customer provided) • Built-in cord management in the base	15.5 x 38"	LAYL	<input type="checkbox"/>	34.0#	\$ 2756

A

B

HOW TO ORDER

- Indicate the following information on order form:
- Quantity of each item.
 - Model number, including options. See "How To Build a Model Number".
 - Any special service required.

- Note:
- The indicates that a choice is required.
 - The absence of the indicates that no choice is required.
 - Alpha-numeric characters in place of indicate that no other alternatives are available.

HOW TO BUILD A MODEL NUMBER

- A** Select basic model.
- B** Select module color.
- | | |
|-----------|---------------|
| CB | - Carbon Grey |
| CO | - Cottonwood |

SPECIAL SERVICES

Special Carton Marking

With specially marked information N/C

Shipping

Ships **assembled, FOB Bonduel, WI 54107, freight prepaid.** Freight class 70.

Specifications and prices are subject to change without prior notice.



MODEL	L	MODEL NUMBER		Approx. Packaged Weight	Delivered Pricing
		Basic Model	Poly Color		
PowerUp® • 108" and 180" cord length for use in non-powered tables • Module designed to fit rectangular KI cutout (3" x 6.25") • Data tree is provided to allow client provided data jacks to be inserted in the module • Cord terminates in a 3-prong plug	108"	14.2360.108	<input type="checkbox"/>	1.00#	\$ 161
	180"	14.2360.180	<input type="checkbox"/>	1.00#	161

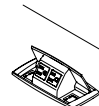

AC412

A **B**

HOW TO ORDER

- Indicate the following information on order form:
- Quantity of each item.
 - Model number, including options. See "How To Build a Model Number".
 - Any special service required.

Note:

- The indicates that a choice is required.
- The absence of the indicates that no choice is required.
- Alpha-numeric characters in place of indicate that no other alternatives are available.

HOW TO BUILD A MODEL NUMBER

- A** Select basic model.
- B** Select poly color
Refer to the **Product Color Options** page in this price list.
- C** Select paint color.
Refer to the **Product Color Options** page in this price list.

SPECIAL SERVICES

Special Carton Marking

With specially marked information N/C

Shipping

Ships **knocked down, FOB Bonduel, WI 54107, freight prepaid.** Freight class 85.

Specifications and prices are subject to change without prior notice.

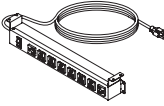

MODEL	MODEL NUMBER		Approx. Packaged Weight	Delivered Pricing
	Basic Model			
 <p>AC434</p> <p>Undermount R8 Module</p> <ul style="list-style-type: none"> • Silver in color • Includes 8-15A, 120 VAC receptacles, 2 outer most rotated 90 degrees to accommodate large plugs • 144" power cord • Under table mount attaches with 4 screws (included) • Module hangs down from surface 1" to allow easier access to plug in/unplug • Includes 4 wire management clips • ETL listed for US and Canada • Dimensions are 16.3" x 2.3" x 2.8" 	14.1450.SLVR		3.00#	\$ 319

A

HOW TO ORDER

- Indicate the following information on order form:
1. Quantity of each item.
 2. Model number, including options. See "How To Build a Model Number".
 3. Any special service required.

- Note:
- The indicates that a choice is required.
 - The absence of the indicates that no choice is required.
 - Alpha-numeric characters in place of indicate that no other alternatives are available.

HOW TO BUILD A MODEL NUMBER

- A** Select basic model.

SPECIAL SERVICES

Special Carton Marking

With specially marked information N/C

Shipping

Ships **knocked down, FOB Bonduel, WI 54107, freight prepaid.** Freight class 125.

Specifications and prices are subject to change without prior notice.

Accessory Power Modules

Dean Clamp-on Module



Accessory Power Modules

Dean Clamp-on Module

	MODEL	Features	MODEL NUMBER		Approx. Packaged Weight	Delivered Pricing
			Basic Model	Module Color		
 AC422	Dean Clamp-on Power Module (Corded)	108" Cord	MOD.MC1.108	<input type="checkbox"/>	1.00#	\$ 328
		180" Cord	MOD.MC1.180	<input type="checkbox"/>	1.00#	340
 AC423	Dean Clamp-on Power Module (Pattern)	40" Pattern Cord	MOD.PMC1.40	<input type="checkbox"/>	1.00#	\$ 386

A

B

HOW TO ORDER

Indicate the following information on order form:

- Quantity of each item.
- Model number, including options. See "How To Build a Model Number".
- Any special service required.

Note: • The indicates that a choice is required.

- The absence of the indicates that no choice is required.
- Alpha-numeric characters in place of indicate that no other alternatives are available.

HOW TO BUILD A MODEL NUMBER

- A** Select basic model.
- B** Select module color.
Refer to the **Product Color Options** page in this price list.

SPECIAL SERVICES

Special Carton Marking

With specially marked information N/C

Shipping

Ships **knocked down, FOB Bonduel, WI 54107, freight prepaid.** Freight class 125.

Specifications and prices are subject to change without prior notice.



Accessory Power Modules

Dean In-surface Module



Accessory Power Modules

Dean In-surface Module

	MODEL	Features	MODEL NUMBER		Approx. Packaged Weight	Delivered Pricing
			Basic Model	Module Color		
 AC424	Dean In-surface Power Module (Corded) • Provides two 3-prong receptacles, one USB-A, one USB-C charging port and data tree • Cord terminates in a 90 degree 3-prong plug • Two strain-relief clips included for wire management • 15A approved • UL listed • For use in Dean In-surface cutout (7.81"x1.93")	108" Cord	MOD.MD1.108	<input type="checkbox"/>	1.00#	\$ 337
		180" Cord	MOD.MD1.180	<input type="checkbox"/>	1.00#	347
 AC425	Dean In-surface Power Module (Pattern) • Provides two 3-prong receptacles, one USB-A, one USB-C charging port and data tree • Pattern Infeed, jumpers, and gangers ordered separately • Wire management not included • 15A approved • ETL listed	20" Cord	MOD.PMD1.20	<input type="checkbox"/>	1.00#	\$ 408
		40" Cord	MOD.PMD1.40	<input type="checkbox"/>	1.00#	419

A

B

HOW TO ORDER

- Indicate the following information on order form:
- Quantity of each item.
 - Model number, including options. See "How To Build a Model Number".
 - Any special service required.

Note:

- The indicates that a choice is required.
- The absence of the indicates that no choice is required.
- Alpha-numeric characters in place of indicate that no other alternatives are available.

HOW TO BUILD A MODEL NUMBER

- A** Select basic model.
- B** Select module color.
Refer to the **Product Color Options** page in this price list.

SPECIAL SERVICES

Special Carton Marking

With specially marked information N/C

Shipping

Ships **knocked down, FOB Bonduel, WI 54107, freight prepaid.** Freight class 125.

Specifications and prices are subject to change without prior notice.



Accessory Power Modules

Dean Undersurface Module



Accessory Power Modules

Dean Undersurface Module

	MODEL	Features	MODEL NUMBER		Approx. Packaged Weight	Delivered Pricing
			Basic Model	Module Color		
 AC426	Dean Undersurface Power Module (Corded) • Provides two 3-prong receptacles, one USB-A and one USB-C charging port • Cord terminates in a 90 degree 3-prong plug • Two strain-relief clips included for wire management • 15A approved • UL listed	108" Cord	MOD.MU1.108	<input type="checkbox"/>	1.00#	\$ 430
		180" Cord	MOD.MU1.180	<input type="checkbox"/>	1.00#	441
 AC427	Dean Undersurface Power Module (Pattern) • Provides two 3-prong receptacles, one USB-A and one USB-C charging port • Pattern Infeed, jumpers, and gangers ordered separately • Wire management not included • 15A approved • ETL listed	40" Cord	MOD.PMU1.40	<input type="checkbox"/>	1.00#	\$ 495

A

B

HOW TO ORDER

- Indicate the following information on order form:
- Quantity of each item.
 - Model number, including options. See "How To Build a Model Number".
 - Any special service required.

- Note:
- The indicates that a choice is required.
 - The absence of the indicates that no choice is required.
 - Alpha-numeric characters in place of indicate that no other alternatives are available.

HOW TO BUILD A MODEL NUMBER

- A** Select basic model.
- B** Select module color.
Refer to the **Product Color Options** page in this price list.

SPECIAL SERVICES

Special Carton Marking

With specially marked information N/C

Shipping

Ships **knocked down, FOB Bonduel, WI 54107, freight prepaid.** Freight class 125.

Specifications and prices are subject to change without prior notice.



Accessory Power Modules

Dubbel Undersurface Module



Accessory Power Modules

Dubbel Undersurface Module

	MODEL	Features	MODEL NUMBER		Approx. Packaged Weight	Delivered Pricing
			Basic Model	Module Color		
 AC420	Dubbel Undersurface Power Module (Corded) • Under table unit attaches with two screws into the worksurface • Provides two 3-prong receptacles and one USB-A and one USB-C charging port • Cord terminates in a 90 degree 3-prong plug • Includes two strain-relief clips included for wire management • 15A approved • UL listed	108" Cord	MOD.MB1.108	<input type="checkbox"/>	1.00#	\$ 257
		180" Cord	MOD.MB1.180	<input type="checkbox"/>	1.00#	269
 AC421	Dubbel Undersurface Power Module (Pattern) • Under table unit attaches with two screws into the worksurface • Provides two 3-prong receptacles and one USB-A and one USB-C charging port • Pattern Infeed, jumpers, and gangers ordered separately • Wire management not included • 15A approved • ETL listed	40" Pattern Cord	MOD.PMB1.40	<input type="checkbox"/>	1.00#	\$ 328

A

B

HOW TO ORDER

- Indicate the following information on order form:
- Quantity of each item.
 - Model number, including options. See "How To Build a Model Number".
 - Any special service required.

- Note:
- The indicates that a choice is required.
 - The absence of the indicates that no choice is required.
 - Alpha-numeric characters in place of indicate that no other alternatives are available.

HOW TO BUILD A MODEL NUMBER

- A** Select basic model.
- B** Select module color.
Refer to the **Product Color Options** page in this price list.

SPECIAL SERVICES

Special Carton Marking

With specially marked information N/C

Shipping

Ships **knocked down, FOB Bonduel, WI 54107, freight prepaid.** Freight class 125.

Specifications and prices are subject to change without prior notice.



Accessory Power Modules

Nacre Pop-up Module



Accessory Power Modules

Nacre Pop-up Module

	MODEL	Features	MODEL NUMBER		Approx. Packaged Weight	Delivered Pricing
			Basic Model	Module Color		
 AC418	Nacre Pop-up Power Module (Cord)	108" Cord	MOD.MA1.108	<input type="checkbox"/>	1.00#	\$ 406
	<ul style="list-style-type: none"> Provides two 3-prong receptacles, one USB-A, one USB-C charging port and data tree Cord terminates in a 90 degree 3-prong plug Two strain-relief clips included for wire management 15A approved UL listed For use in Nacre Pop-up cutout (6.94"x3") 	180" Cord	MOD.MA1.180	<input type="checkbox"/>	1.00#	417
 AC419	Nacre Pop-up Power Module (Pattern)	20" Cord	MOD.PMA1.20	<input type="checkbox"/>	1.00#	\$ 586
	<ul style="list-style-type: none"> Provides two 3-prong receptacles, one USB-A, one USB-C charging port and data tree Pattern Infeed, jumpers, and gangers ordered separately Wire management not included 15A approved ETL listed 	40" Cord	MOD.PMA1.40	<input type="checkbox"/>	1.00#	596

A

B

HOW TO ORDER

- Indicate the following information on order form:
- Quantity of each item.
 - Model number, including options. See "How To Build a Model Number".
 - Any special service required.

- Note:
- The indicates that a choice is required.
 - The absence of the indicates that no choice is required.
 - Alpha-numeric characters in place of indicate that no other alternatives are available.

HOW TO BUILD A MODEL NUMBER

- A** Select basic model.
- B** Select module color.
Refer to the **Product Color Options** page in this price list.

SPECIAL SERVICES



Special Carton Marking

With specially marked information N/C

Shipping
Ships **knocked down, FOB Bonduel, WI 54107, freight prepaid.** Freight class 125.

Specifications and prices are subject to change without prior notice.



	MODEL	Features	MODEL NUMBER		Approx. Packaged Weight	Delivered Pricing
			Basic Model	Module Color		
 AC428	Node In-surface Power Module (Corded)	108" Cord	MOD.MO1.108	<input type="checkbox"/>	1.00#	\$ 246
		180" Cord	MOD.MO1.180	<input type="checkbox"/>	1.00#	257
 AC429	Node In-surface Power Module (Pattern)	20" Pattern Cord	MOD.PM01.20	<input type="checkbox"/>	1.00#	\$ 328
		40" Pattern Cord	MOD.PM01.40	<input type="checkbox"/>	1.00#	340

A

B

HOW TO ORDER

- Indicate the following information on order form:
- Quantity of each item.
 - Model number, including options. See "How To Build a Model Number".
 - Any special service required.

- Note:
- The indicates that a choice is required.
 - The absence of the indicates that no choice is required.
 - Alpha-numeric characters in place of indicate that no other alternatives are available.

HOW TO BUILD A MODEL NUMBER

- A** Select basic model.
- B** Select module color. Refer to the **Product Color Options** page in this price list.

SPECIAL SERVICES

Special Carton Marking

With specially marked information N/C

Shipping

Ships **knocked down, FOB Bonduel, WI 54107, freight prepaid.** Freight class 125.

Specifications and prices are subject to change without prior notice.

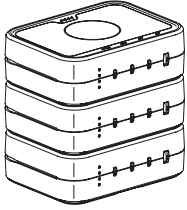

MODEL	Features	W x H x D	MODEL NUMBER		Approx. Packaged Weight	Delivered Pricing	
			Basic Model	Module Color			
 <p>AC400</p> <p>Thesis Battery Power Module - 3 Pack</p> <ul style="list-style-type: none"> • Contains 3 battery modules and 1 charging cord • Each battery contains two 100W USB-C, one 20W USB-C, one 10W USB-A ports and one 15W wireless charging pad • LED lights on front indicate charge level of battery • Includes handle for portability • Space efficient charging stack up to 3 batteries to charge with one USB-C charging cord • Built-in hidden Wayfinder pocket compatible with customer-supplied Apple AirTag, Eufy SmartTrack or Tile by Life360 • Fully charged 216Wh battery is capable of charging 3-4 laptops from 20% to 80%. The time to charge typical laptop is about 1-2 hours (estimated) • Can charge (from 1-100%) about 18-21 average smart phones, 12-15 larger smart phones/small tablets or 6 larger tablets. Time to charge typical smart phone (20W) is 1-2 hours (estimated) • Optional above and below surface mounting brackets available • 3 batteries stacked to charge is 7.25"H 	3 Pack	7.1 x 2.4 x 5.3"	AC400TH3	□□	12.0#	\$ 5545	

A

B

HOW TO ORDER

- Indicate the following information on order form:
1. Quantity of each item.
 2. Model number, including options. See "How To Build a Model Number".
 3. Any special service required.

- Note:
- The □ indicates that a choice is required.
 - The absence of the □ indicates that no choice is required.
 - Alpha-numeric characters in place of □ indicate that no other alternatives are available.

HOW TO BUILD A MODEL NUMBER

- A** Select basic model.
- B** Select module color.
Refer to the **Product Color Options** page in this price list.

SPECIAL SERVICES

Special Carton Marking

With specially marked information N/C

Shipping

Ships **knocked down, FOB Bonduel, WI 54107, freight prepaid.** Freight class 125.

Specifications and prices are subject to change without prior notice.

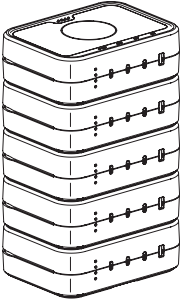

MODEL	Features	W x H x D	MODEL NUMBER		Approx. Packaged Weight	Delivered Pricing
			Basic Model	Module Color		
 <p>AC400</p> <p>Thesis Battery Power Module - 5 Pack</p> <ul style="list-style-type: none"> • Contains 5 battery modules and 1 charging cord • Each battery contains two 100W USB-C, one 20W USB-C, one 10W USB-A ports and one 15W wireless charging pad • LED lights on front indicate charge level of battery • Includes handle for portability • Space efficient charging stack up to 5 batteries to charge with one USB-C charging cord • Built-in hidden Wayfinder pocket compatible with customer-supplied Apple AirTag, Eufy SmartTrack or Tile by Life360 • Fully charged 216Wh battery is capable of charging 3-4 laptops from 20% to 80%. The time to charge typical laptop is about 1-2 hours (estimated) • Can charge (from 1-100%) about 18-21 average smart phones, 12-15 larger smart phones/small tablets or 6 larger tablets. Time to charge typical smart phone (20W) is 1-2 hours (estimated) • Optional above and below surface mounting brackets available • 5 batteries stacked to charge is 12.125"H 	5 Pack	7.1 x 2.4 x 5.3"	AC400TH5	<input type="checkbox"/>	18.0#	\$ 8800

A

B

HOW TO ORDER

- Indicate the following information on order form:
1. Quantity of each item.
 2. Model number, including options. See "How To Build a Model Number".
 3. Any special service required.

- Note:
- The indicates that a choice is required.
 - The absence of the indicates that no choice is required.
 - Alpha-numeric characters in place of indicate that no other alternatives are available.

HOW TO BUILD A MODEL NUMBER

- A** Select basic model.
- B** Select module color.
Refer to the **Product Color Options** page in this price list.

SPECIAL SERVICES

Special Carton Marking

With specially marked information N/C

Shipping

Ships **knocked down, FOB Bonduel, WI 54107, freight prepaid.** Freight class 125.

Specifications and prices are subject to change without prior notice.

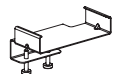
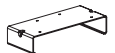

	MODEL	Features	MODEL NUMBER		Approx. Packaged Weight	Delivered Pricing
			Basic Model	Bracket Color		
 AC400	Edgemount Thesis Battery Module Bracket	1 Pack	AC400BE1	<input type="checkbox"/>	0.0#	\$ 91
		3 Pack	AC400BE3	<input type="checkbox"/>	0.0#	239
		5 Pack	AC400BE5	<input type="checkbox"/>	0.0#	371
		<ul style="list-style-type: none"> Bracket clamps onto edge of a work-surface 3/4" to 1-1/2" thick with thumb screws Thesis Battery Module slides in and out of the bracket within it's integrated rail without the use of tools for ease of charging Wireless charging still accessible when using this bracket 				
 AC400	Undermount Thesis Battery Module Bracket	1 Pack	AC400BU1	<input type="checkbox"/>	0.0#	\$ 91
		3 Pack	AC400BU3	<input type="checkbox"/>	0.0#	239
		5 Pack	AC400BU5	<input type="checkbox"/>	0.0#	371
		<ul style="list-style-type: none"> Attaches to underside of a worksurface using screws Thesis Battery Module slides in and out of the bracket within it's integrated rail without the use of tools for ease of charging Due to placement of bracket, wireless charging built into top of Thesis module will be inaccessible 				

A

B

HOW TO ORDER

- Indicate the following information on order form:
- Quantity of each item.
 - Model number, including options. See "How To Build a Model Number".
 - Any special service required.

- Note:
- The indicates that a choice is required.
 - The absence of the indicates that no choice is required.
 - Alpha-numeric characters in place of indicate that no other alternatives are available.

HOW TO BUILD A MODEL NUMBER

- A** Select basic model.
- B** Select bracket paint color. Refer to the **Product Color Options** page in this price list.

SPECIAL SERVICES

Special Carton Marking

With specially marked information N/C

Shipping

Ships **knocked down, FOB Bonduel, WI 54107, freight prepaid.** Freight class 125.

Specifications and prices are subject to change without prior notice.

Accessory Power Modules

Vesta Battery Power Tower



Accessory Power Modules

Vesta Battery Power Tower

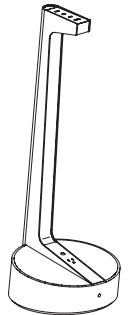
MODEL	W x H x D	MODEL NUMBER		Approx. Packaged Weight	Delivered Pricing
		Basic Model	Module Color		
 <p>Vesta Battery Power Tower</p> <ul style="list-style-type: none"> • Contains 1 Power Tower and 1 charging cord • Each battery powered tower has two 100W USB-C, one 20W USB-C, one 10W USB-A ports and one 110W three-prong outlet in base • On/off switch allows for battery conservation • LED lights on top indicate charge level of battery • Fully charged 432Wh battery is capable of charging 7-8 laptops from 20% to 80%. The time to charge typical laptop is about 1-2 hours (estimated) • Can charge (from 1-100%) about 36-42 average smart phones, 24-30 larger smart phones or 12 larger tablets. Time to charge typical smart phone (20W) is 1-2 hours (estimated) 	12 x 28.25 x 12"	AC401VB	<input type="checkbox"/>	16.00#	\$ 3999

AC401

A

B

HOW TO ORDER

- Indicate the following information on order form:
1. Quantity of each item.
 2. Model number, including options. See "How To Build a Model Number".
 3. Any special service required.

- Note:
- The indicates that a choice is required.
 - The absence of the indicates that no choice is required.
 - Alpha-numeric characters in place of indicate that no other alternatives are available.

HOW TO BUILD A MODEL NUMBER

- A** Select basic model.
- B** Select module color. Refer to the **Product Color Options** page in this price list.

SPECIAL SERVICES

Special Carton Marking

With specially marked information N/C

Shipping

Ships **knocked down, FOB Bonduel, WI 54107, freight prepaid**. Freight class 125.

Specifications and prices are subject to change without prior notice.

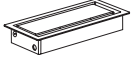
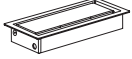
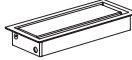

MODEL	MODEL NUMBER		Approx. Packaged Weight	Delivered Pricing
	Basic Model	Paint Color		
 Metal Grommet Kit for Villa • Metal grommet design fits within 6.25" x 3" Villa cutout AC411	GRM.VG1	<input type="checkbox"/>	1.00#	\$ 92
 Metal Grommet Kit for Nacre • Fits within 6.94" x 3" Nacre cutout AC411	GRM.GA1	<input type="checkbox"/>	1.00#	\$ 84
 Metal Grommet Kit for Dean • Fits within 7.81" x 1.93" Dean cutout AC411	GRM.GD1	<input type="checkbox"/>	1.00#	\$ 84
Plastic Grommet • Fits within 6.25" x 3" Villa cutout AC410	46.0881	<input type="checkbox"/>	1.00#	\$ 7

A

B

HOW TO ORDER

- Indicate the following information on order form:
1. Quantity of each item.
 2. Model number, including options. See "How To Build a Model Number".
 3. Any special service required.

- Note:
- The indicates that a choice is required.
 - The absence of the indicates that no choice is required.
 - Alpha-numeric characters in place of indicate that no other alternatives are available.

HOW TO BUILD A MODEL NUMBER

- A** Select basic model.
- B** Select paint color. Refer to the **Product Color Options** page in this price list.

SPECIAL SERVICES



Special Carton Marking

With specially marked information N/C

Shipping
 Ships **knocked down, FOB Bonduel, WI 54107, freight prepaid.** Freight class 125.

Specifications and prices are subject to change without prior notice.

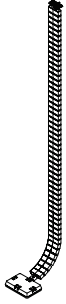

		MODEL NUMBER			
MODEL	Features	Basic Model	Approx. Packaged Weight	Delivered Pricing	
 HDMI	HDMI Connector <ul style="list-style-type: none"> • Add HDMI connection to Dean In-surface or Nacre Pop-up modules with open data ports • 18" black connector cord • Female/female connection • Fits into open data port with standard cover included with modules 	HDMI	0.00#	\$	74
 AC403	Vertical Cable Manager <ul style="list-style-type: none"> • Silver in color • Multi-directional manager holds wires in static and adjustable tables • Weighted base keeps manager in position • Includes magnetic link to easily attach to table leg • Attaches to underside of table with or without wire management trough • Includes 63 links, 1-3 link magnetic piece, 1 top connector, 2 screws, 1 base plate 	47.2320.SLVR	1.00#	\$	118
 AC402	Velcro Wire Manager Kit <ul style="list-style-type: none"> • Attaches wires to underside of table • Kit includes 1 velcro manager, 2 mounting tabs, 4 mounting screws. 	87.9323	0.00#	\$	16

A

HOW TO ORDER

- Indicate the following information on order form:
1. Quantity of each item.
 2. Model number, including options. See "How To Build a Model Number".
 3. Any special service required.

- Note:
- The indicates that a choice is required.
 - The absence of the indicates that no choice is required.
 - Alpha-numeric characters in place of indicate that no other alternatives are available.

HOW TO BUILD A MODEL NUMBER

- A** Select basic model.

SPECIAL SERVICES

Special Carton Marking

With specially marked information N/C

Shipping

Ships **knocked down, FOB Bonduel, WI 54107, freight prepaid.** Freight class 125.

Specifications and prices are subject to change without prior notice.

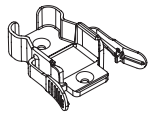

MODEL	Features	MODEL NUMBER		Approx. Packaged Weight	Delivered Pricing
		Basic Model			
AC432	Pattern Jumper • Each jumper kit includes jumper and grey power distribution block • Review product Planning Guide for table-to-table jumper length guidance.	12"	JPPAT.12	1.00#	\$ 74
		29"	JPPAT.29	1.00#	111
		53"	JPPAT.53	1.00#	115
		75"	JPPAT.75	1.00#	121
		101"	JPPAT.101	1.00#	147
AC431	Pattern Infeed • 108" cord plugs into standard 15 amp outlet • Kit includes Pattern infeed, grey power distribution block, 12" Pattern jumper and white power distribution block • Can be installed anywhere in the run (middle or end) • Jumper length cannot exceed 600" or 50' per infeed • 90 degree angled plug; plug dimensions 2"x1-1/2"x1-7/8" • Includes one Pattern quick release tool • Does not include vertical wire management • ETL listed		IFPAT	0.00#	\$ 322
	Pattern Quick Release Tool • Snaps onto Pattern plugs to make disconnecting Pattern connections easier • Can be moved to multiple connections • Stores snapped onto one connection for easy access		BE04878.BL	0.00#	\$ 3

A

HOW TO ORDER

- Indicate the following information on order form:
- Quantity of each item.
 - Model number, including options. See "How To Build a Model Number".
 - Any special service required.

Note:

- The indicates that a choice is required.
- The absence of the indicates that no choice is required.
- Alpha-numeric characters in place of indicate that no other alternatives are available.

HOW TO BUILD A MODEL NUMBER

- A** Select basic model.
- B** Select paint color. Refer to the **Product Color Options** page in this price list.

SPECIAL SERVICES

Special Carton Marking

With specially marked information N/C

Shipping

Ships **knocked down, FOB Bonduel, WI 54107, freight prepaid.** Freight class 125.

Specifications and prices are subject to change without prior notice.



1330 BELLEVUE STREET
GREEN BAY, WI 54302
800.424.2432 / KI.COM

KI is a trusted expert for furniture and wall systems around the globe.
USA | CANADA | MEXICO | UK | EUROPE | ASIA | MIDDLE EAST
© 2026 Krueger International, Inc. All Rights Reserved.