

Finale Casegoods Product Information:

Exterior Wood Materials: Exterior surfaces are made from the finest selected veneers to achieve clarity and consistency in the Finale product line. To attain a pleasing, symmetrical pattern, all veneers in Finale are book-matched. All exterior solid lumber is matched to coordinate with the veneer.

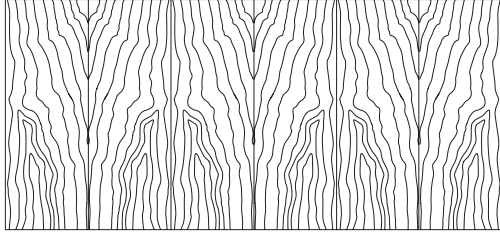

Book Matched Example

Alternating pieces of veneer are flipped over so they face each other like the pages within a book

Finale is available in flat cut cherry, maple and walnut veneer. A wide range of wood stains have been formulated to enhance the beauty of the veneer.

Work Surface Construction: Tops are 5-ply balanced construction, 1 3/8" thick with solid matching hardwood edges. Surfaces are available in wood veneer or high pressure laminate. No additional charge for using our coordinating high pressure laminate with a veneer grain pattern.

Case Construction: Outside panels are 1 3/8" and joined together by mortise and tenon construction. In addition to mortise and tenon joint construction, pedestal joints are reinforced with screws, cleats, brackets and glue. Leveling glides are set into solid hardwood blocks with t-nut inserts, which helps to prevent the leveling glide from tear out. Tops are secured to the chassis with top fastening cleats screwed to the inside of the panels.

Cabinet doors have 110° swing hinges to allow adequate access into the interior of the cabinet.

Drawers: The 9ply unidirectional hardwood sides of the drawer box are 7/16" thick assembled with English dovetail construction at each corner of the box. The drawer bottom panel is 1/4" thick fitting into a groove machined the into side of the box. Interiors are sanded and coated with clear U.V. finish to protect against shrinking, swelling or warping, and to provide a clean, smooth feel and appearance.

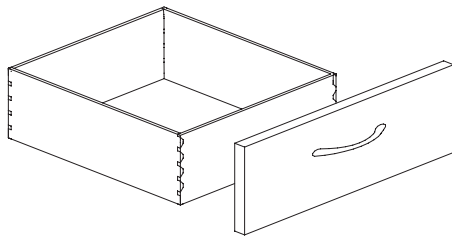

Drawer Suspension: The high quality black drawer suspensions carry a lifetime warranty. Slides feature steel ball bearings for longer life with cushioned in/out stops. File and box drawers have 100% full extension with over travel.

Filing Hardware: All file drawers are constructed with a custom designed filing system in place to allow for hanging folders.

Locking: All desks, credenzas and returns feature pedestal locking and lateral files feature central locking to provide maximum security and flexibility.

Units are shipped randomly keyed as standard (units in the grouping are keyed alike). Keyed alike units available if requested at no upcharge. Removable cores for in-field re-keying are standard.

Finish - Stain/Colors: We offer a variety of wood stains and paint colors on Finale. Please see the chart below. Samples are available upon request.

ESS Essentials Veneer Collection

BRK	Brickdust	OBK	Outback
CSK	Cask	PIL	Pilsner
CLY	Clay	SIE	Sienna
FLX	Flax	TRF	Truffle
MES	Mesa	UMB	Umber
MCH	Mocha		

Protective Top Coat: DuraTex™ offers exceptional hardness along with abrasion and impact resistance, it has been formulated to eliminate hazardous and harmful gases that are normally associated with wood finish.

DuraTex™ Features:

Safety - Significantly reduces hazardous formaldehyde emissions which help improve the quality of the of the indoor air we breathe.
Quality - Developed to be tough and durable with special attention to appearance. The DuraTex™ finish preserves the natural beauty of wood.
Durability - Designed to meet a wide range of demanding performance and environmental standards to withstand even the highest wear and tear.



CORPORATE OFFICE
 225 CLAY STREET
 JASPER, INDIANA 47546



800.457.4511 **TOLL FREE**
 812.482.3204 **OFFICE**
 812.482.1548 **FAX**



JSIFURNITURE.COM



CONTACT JSI

Finale Casegoods Product Information:

Laminate Tops: Worksurface only, no additional upcharge if coordinating wood grain laminate is specified. Contact Customer Service for any other laminate request. Listed below are finishes that have coordinating wood grain HPL laminates.

ESS Essentials Veneer with Laminate Top

BRK	Brickdust	MCH	Mocha
CSK	Cask	OBK	Outback
CLY	Clay	PIL	Pilsner
MES	Mesa	UMB	Umber

Finish Sheen: All casegood veneer finishes are standard in 35-sheen. All other finishes are available in 15-sheen, with a 5% upcharge, per model.

Custom/Special Finishes: JSI, upon request, will accommodate special finishes. A written request is required to proceed with custom finish orders. A sample reference is required for first-time matches and must be included with the written request.

There is a one-time upcharge per order for any non-standard wood finish.

Orders will be entered noting the special finish. A sample match will be provided to the customer. Written approval is needed before the finish process can be started. Delays in approval may have an impact on lead times.

Every effort will be made to create the requested match; however, an acceptable match may not be possible because of natural variations of wood. These natural variations can also cause minor differences in the final finish product.

Use standard pricing and option pricing for each line item with a special finish, unless additional modifications have been specified. For items available in both Essential and Artisan veneers, apply the Essentials pricing.

Pedestal Configuration Change: Box-box-file configuration is standard on all desks and file-file configuration is standard on all return units.

Finale drawer configuration on pedestals 27" to 30" high can be switched out either to a box-box-file or file-file configuration, but must be specified at the time of order with an additional upcharge per pedestal.

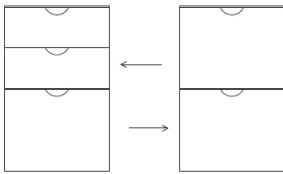

Writing Shelf - Pullout (Arm Slide): Desk Pedestals in Finale can have an optional pullout shelf above the top drawer for additional writing surface. Add upcharge to the list for each pedestal.

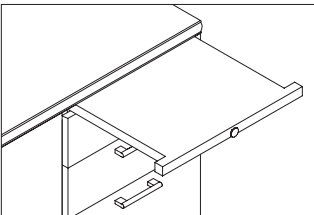

Finale Casegoods Product Information:

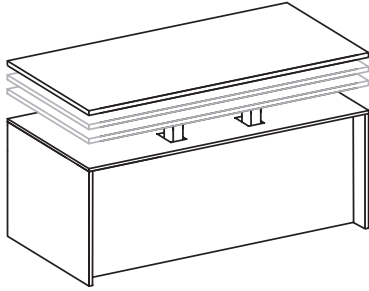

ERGO Adjustable Work Height Mechanism

Our proprietary adjustable work height mechanism can be specified on many of the models in Finale.

ERGO mechanism allows height adjustability to be added to the worksurface. Our solution uses a standardized design that minimizes the modifications required to standard desk, bridge or credenza models. The mechanism and control box are neatly concealed to maintain the appearance of the original elegance of the product. A push button activates the electric powered lifting columns for adjustability from sitting height to a standing height. A 3/4" thick finished sub top is added to the top of the desk chassis for a clean appearance when the surface is in the raised position. In the lowered position, please note that ERGO adds 3/4" to the standard height of the desk and the installation will decrease kneespace depth by 8".

Automatic Collision Control is built in to each mechanism as a standard feature. When the system senses an obstacle obstructing the movement, the mechanism will reverse direction and retreat by 1".

When ERGO is added to a worksurface in an "L" or "U" group, all units in the configuration need to have a sub top added. These units are considered to be ERGO ADJACENT units. ERGO ADJACENT units must have a fixed height worksurface that matches the lowest position of the ERGO mechanism and the top. This is accomplished by adding a 3/4" sub top between the chassis and the worksurface. This feature can also be specified for cabinets which may sit next to a unit with the ERGO mechanism.

Height adjustment starts at 30 1/4", to a standing height of 49 3/4", a range of 19 1/2".

To specify the unit that has the mechanism, add **ERGO** to the end of the model number.
To specify the connecting or adjacent units add, **ERGO ADJACENT** to the end of the model number.

Note: The kneespace depth is decreased when the ERGO mechanism is specified. Contact Customer Service for dimension information.

Availability of Finale Units with the Mechanism:

Freestanding Units: Units do not require adjacent products; select **ERGO** and add an upcharge.

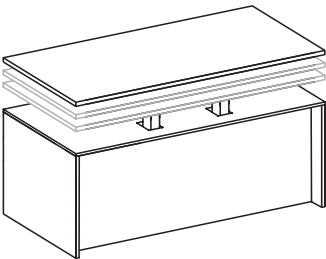

ERGO Adjacent Connecting Units: To include height adjustment, select the **ERGO** option for the desired model with an upcharge.

For any units that connect to an ERGO model, you must select the ERGO Adjacent option for each of the connecting units.

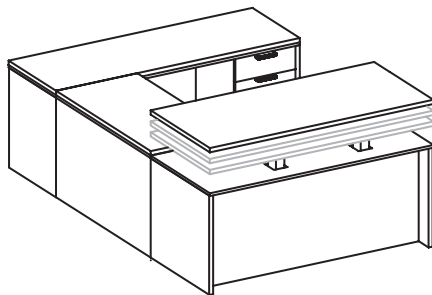

Adjustable Single Pedestal Desk

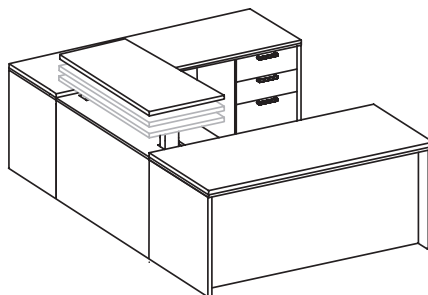

Adjustable Height Bridge

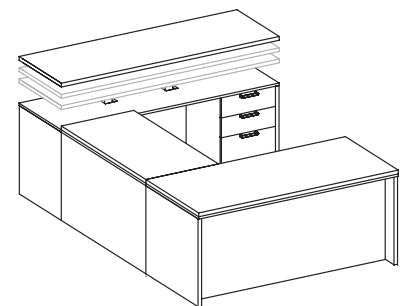

Adjustable Height Credenza



Finale Casegoods Product Information:

Layouts

Two heights of storage overheads are available in Finale.

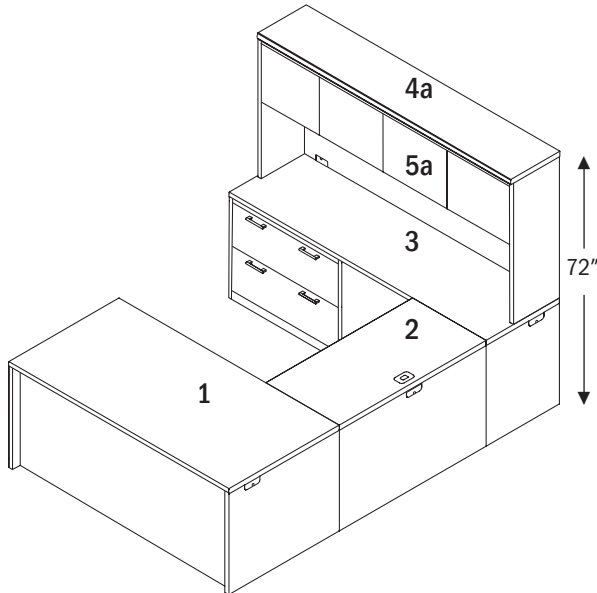

Finale is an easily specified contemporary product line, with standard office furniture sizes.

Easily specified and setup while providing well established layouts in the office environment.

- 1 Single Pedestal Desk**, with the standard box, box, file pedestal configuration and side locking. Standard side grommet keeps the desk top clean from wires, while still having convenient wire management.
- 2 Bridge** standard with top and back panel grommet and mounting hardware.
- 3 Lateral File Credenza** available with fixed back panel.
- 4a Cabinet Top** is a standard feature on 42" high overhead cabinets.
- 4b Modular Cabinet Top** (not shown in diagram) is an option on 54" high overhead cabinet. These tops are ordered separately.
- 5a Overhead Cabinet** height is 42" for an overall height 72" Standard with left and right grommets on the back panel. Models are available with frameless glass doors in white back painted. (Locks and pulls are not available with glass doors). Models with installed cubbies are also available.
- 5b Overhead Cabinet** height is 54" for an overall height 84" (add 1 3/16" if specifying modular cabinet tops). Standard with left and right grommets on the back panel. Shown with frameless white back painted glass doors. (Locks and pulls are not available with glass doors) Models are also available in wood doors.

Note: Tackboard or panels can be ordered for the inside back of the overhead cabinet, along with the accessory rails.

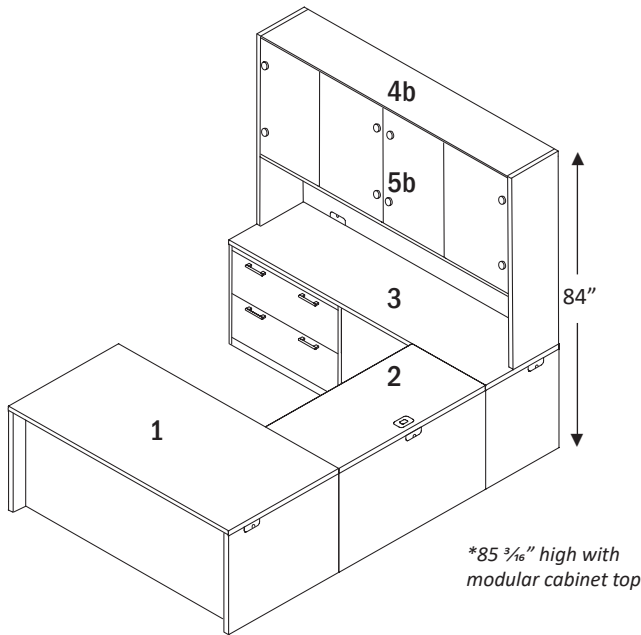

Modular Cabinet Tops
Overhead Cabinets 54" tall do not come with modular cabinet tops. Tops can be specified and ordered separately. To maintain the same finish height on all units, specify tops for **ALL** adjacent units.

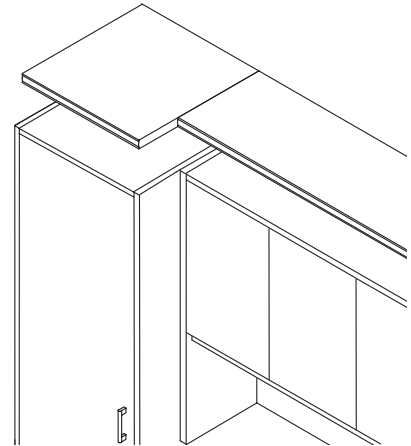

Frameless opaque glass doors in white back painted brings a nice aesthetic to the Finale product line.

Finale Casegoods Product Information:

Pull Style and Color Options

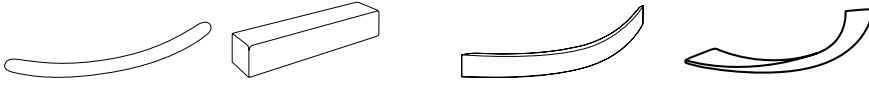

Arch
Matte Black (MBK)
Matte Silver (MSL)

Block
Matte Nickel (MNK)

Curve
Matte Nickel (MNK)

Twist
Matte Nickel (MNK)

Top Edge Details

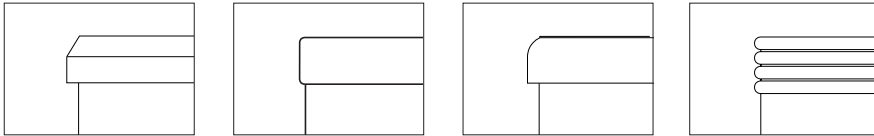

Bevel (B)

Eased (R4)

Gael (G)

Reeded (H)

Top Edge Detail Location

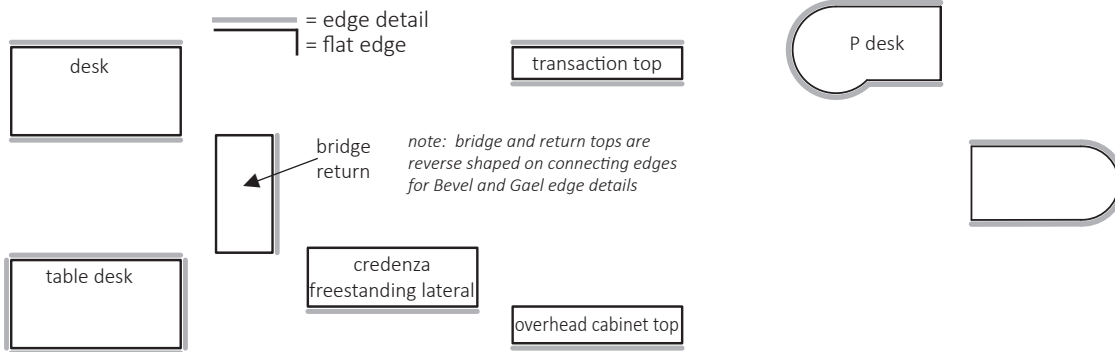

Standard Grain Direction

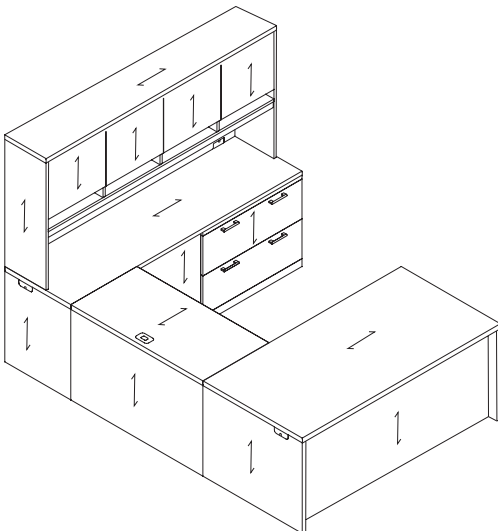

Note:
Grain direction on Return and Bridge units run short grain.

Grain on valance rails on overhead cabinet run vertical.

Finale Casegoods Product Information:

Grommet and Color Options

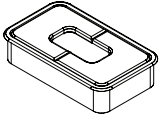

Work Surface Grommet
Matte Black (MBK)
Stardust Silver (STS)

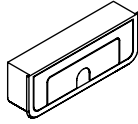

End Panel Grommet
Matte Black (MBK)
Stardust Silver (STS)

Work Surface Grommet Locations

Additional work surface grommets can be specified on desk, bridges, returns and credenzas. Grommet locations are indicated below with an (A) for left, (B) for center, (C) for right and (D) for center end.

Add an upcharge to the list for each additional grommet.

Grommet color must be specified, select Matte Black or Stardust Silver choose one color for all grommets. If no color is selected, grommet color will coordinate with the pull color. Lock cores will coordinate with grommet color Matte Black (MBK) or Stardust Silver (STS)

36" d Pedestal Desk

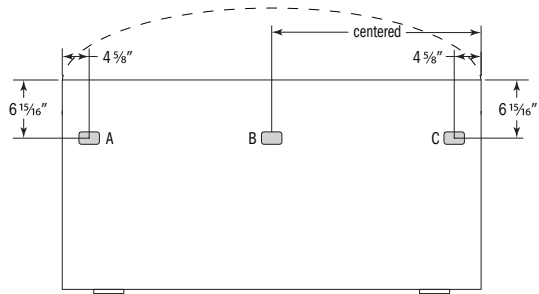

Support End and Run-Off Desk

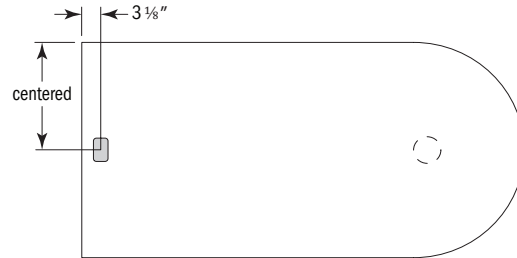

30" d Pedestal Desk

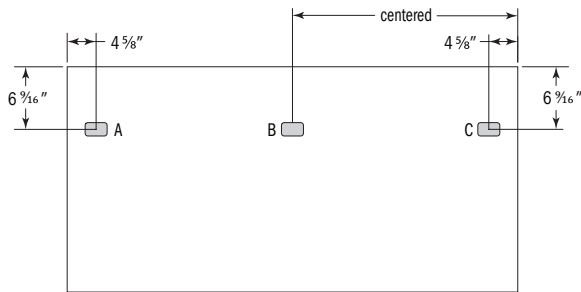

Bridges, Returns and Credenzas

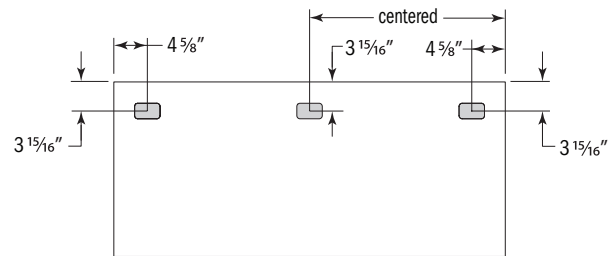

End/Back Panel Grommet

Finale features grommets and wire pass thru on all of the cabinets. This allows wiring to move from unit to unit or from unit to the data or power source. The end/back panel grommets are standard, for any special consideration contact Customer Service.

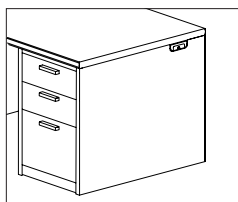

Desks - Credenza
End Panel Grommet

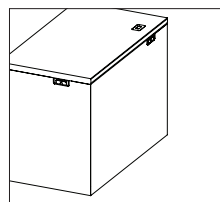

Returns
Work Surface Grommet
End Panel Grommet
Back Panel Grommet

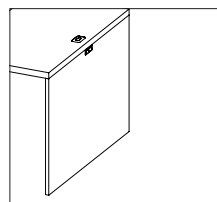

Bridge
Work Surface Grommet
Back Panel Grommet

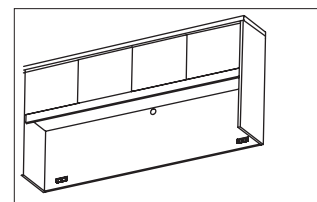

Overhead Cabinet
Back Panel Grommet
Back Center Pass Thru

Note: See the accessory section in this price list for additional wiring and power/data options.

Finale Casegoods Product Information:

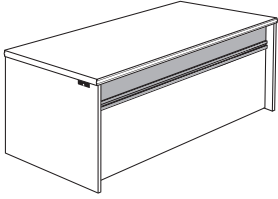

Trim Modesty Panel

- Decorative metal in 3 finishes
 - Black Sandtex (BSX)
 - Soft Nickel (SNK)
 - Stardust Silver (STS)
- Top panel in Veneer
 - White Back Painted Glass (not low iron)
- Available on
 - Recess Modesty Desks
 - Table Desks
 - Bullet Desk
 - P Style Desk

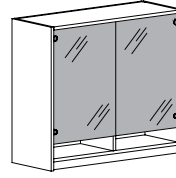

Glass Doors

- Frameless Tempered Glass
 - Puck Style Hinges
 - Aluminum Color
- Back Painted Glass
 - White (not low iron)
- Available on
 - Overhead Cabinets
 - Storage Towers

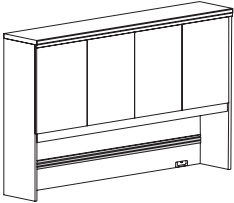

Aluminum Accessory Rail

- Anodized Aluminum Finish
- Accessory Tools
 - Upright Tray
 - Small Tray
 - Pencil Tray
 - Paper Tray
 - File Hanger

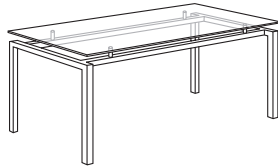
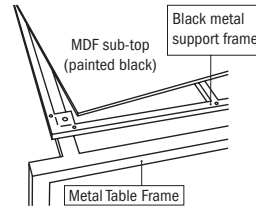

Table Desk

- Top Surface
 - Clear Glass
 - White Back Painted Glass (not low iron)
 - Veneer
 - COM (*right diagram*)
- Frame Finishes
 - Black Sandtex (BSX)
 - Soft Nickel (SNK)
 - Stardust Silver (STS)



Customer Supplies Top (COM)

- Table Frame with Support
- Allows for Unique Materials
- Frame Finishes
 - Black Sandtex (BSX)
 - Soft Nickel (SNK)
 - Stardust Silver (STS)

Finale Conference Product Information:

Exterior Wood Materials: Exterior surfaces are made from the finest selected veneers to achieve clarity and consistency in the Finale product line. To attain a pleasing, symmetrical pattern, all veneers in Finale are book-matched. All exterior solid lumber is matched to coordinate with the veneer.

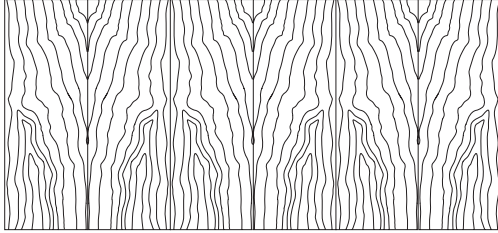

Book Matched Example

Alternating pieces of veneer are flipped over so they face each other like the pages within a book.

Finale is available in flat cut cherry, maple and walnut veneer. A wide range of wood stains have been formulated to enhance the beauty of the veneer.

Solid painted finishes on the veneer are also offered to provide an accent to the Finale product.

Work Surface Construction: Tops are 5-ply balanced construction, 1 3/16" thick with solid matching hardwood edges. Tops are available in six edge profile.

Matching or coordinating high pressure laminate in a veneer grain can be applied to the top surface and is available at no additional charge.

Base Construction: Panels are joined together by mortise and tenon construction. In addition to mortise and tenon joint construction. Leveling glides are set into solid hardwood with t-nut inserts, which helps to prevent the leveling glide from tear out. Tops are secured to the bases with top fastening cleats screwed to the inside of the panels.

Drawers: The 9ply unidirectional hardwood sides of the drawer box are 7/16" thick assembled with English dovetail construction at each corner of the box. The drawer bottom panel is 1/4" thick fitting into a groove machined into the side of the box. Interiors are sanded and coated with clear U.V. finish to protect against shrinking, swelling or warping, and to provide a clean, smooth feel and appearance.

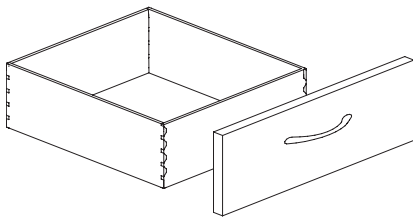

Drawer Suspension: The high quality black drawer suspensions carry a lifetime warranty. Slides feature steel ball bearings for longer life with cushioned in/out stops. File and box drawers have 100% full extension with over travel.

Finish - Stain/Colors: We offer a variety of wood stains and paint colors on Finale. Please see the chart below. Samples are available upon request.

ESS Essentials Veneer Collection

BRK	Brickdust	OBK	Outback
CSK	Cask	PIL	Pilsner
CLY	Clay	SIE	Sienna
FLX	Flax	TRF	Truffle
MES	Mesa	UMB	Umber
MCH	Mocha		

Protective Top Coat: DuraTex™ offers exceptional hardness along with abrasion and impact resistance, it has been formulated to eliminate hazardous and harmful gases that are normally associated with wood finish.

DuraTex™ Features

Safety - Significantly reduces hazardous formaldehyde emissions, which help improve the quality of the of the indoor air we breathe.

Quality - Developed to be tough and durable with special attention to appearance. The DuraTex™ finish preserves the natural beauty of wood.

Durability - Designed to meet a wide range of demanding performance and environmental standards to withstand even the highest wear and tear.



Finale Conference Product Information:

Laminate Tops: Worksurface only, no additional upcharge if coordinating wood grain laminate is specified. Contact Customer Service for any other laminate request. Listed below are finishes that have coordinating wood grain HPL laminates.

ESS Essentials Veneer with Laminate Top

- | | |
|---------------|-------------|
| BRK Brickdust | MCH Mocha |
| CSK Cask | OBK Outback |
| CLY Clay | UMB Umber |
| MES Mesa | |

Custom/Special Finishes: JSI, upon request, will accommodate special finishes. A written request is required to proceed with custom finish orders. A sample reference is required for first-time matches and must be included with the written request.

There is a one-time charge per order for any non-standard wood finish.

Orders will be entered noting the special finish. A sample match will be provided to the customer. Written approval is needed before the finish process can be started. Delays in approval may have an impact on lead times.

Every effort will be made to create the requested match; however, an acceptable match may not be possible because of natural variations of wood. These natural variations can also cause minor differences in the final finish product.

Use standard pricing and option pricing for each line item with a special finish, unless additional modifications have been specified. For items available in both Essential and Artisan veneers, apply the Essentials pricing.

Finish Sheen: All veneer finishes, for Finale are standard in 35-sheen. All other finishes can have their sheen modified with a 15% upcharge added to the list price of each item.

Finale Conference Product Information:

Top Edge Details

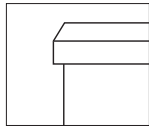

Bevel (B)

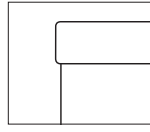

Eased (R4)

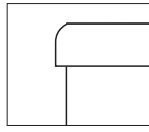

Gael (G)

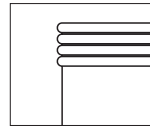

Reeded (H)

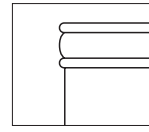

Transitional (C)

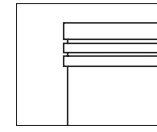

Triad (F)

Drawer Style Color Options



Arch (MBK) (MSL)

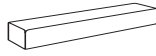

Block (MNK)



Curve (MNK)



Twist (MNK)

Top Shapes - size - base requirement - seating capacity

top sizes 108" through 192" are 2 pieces top sizes above 192" are 3 pieces

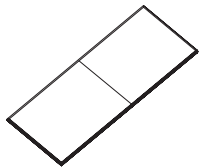

rectangular

264" x 60"	4 bases	seats 24
240" x 60"	4 bases	seats 22
216" x 60"	4 bases	seats 20
192" x 60"	3 bases	seats 18
264" x 54"	4 bases	seats 22
240" x 54"	4 bases	seats 20
216" x 54"	4 bases	seats 18
192" x 54"	3 bases	seats 16
264" x 48"	4 bases	seats 22
240" x 48"	4 bases	seats 20
216" x 48"	4 bases	seats 18
192" x 48"	3 bases	seats 16
168" x 48"	3 bases	seats 14
144" x 48"	3 bases	seats 12
120" x 48"	2-3* bases	seats 8
120" x 42"	2-3* bases	seats 8
108" x 42"	2 bases	seats 8
96" x 48"	2 bases	seats 8
96" x 42"	2 bases	seats 8
84" x 42"	2 bases	seats 8
72" x 36"	2 bases	seats 6



racetrack

264" x 60"	4 bases	seats 24
240" x 60"	4 bases	seats 22
216" x 60"	4 bases	seats 20
192" x 60"	3 bases	seats 18
264" x 54"	4 bases	seats 22
240" x 54"	4 bases	seats 20
216" x 54"	4 bases	seats 18
192" x 54"	3 bases	seats 16
264" x 48"	4 bases	seats 22
240" x 48"	4 bases	seats 20
216" x 48"	4 bases	seats 18
192" x 48"	3 bases	seats 16
168" x 48"	3 bases	seats 14
144" x 48"	3 bases	seats 12
120" x 48"	2-3* bases	seats 8
120" x 42"	2-3* bases	seats 8
108" x 42"	2 bases	seats 8
96" x 48"	2 bases	seats 8
96" x 42"	2 bases	seats 8
84" x 42"	2 bases	seats 8
72" x 36"	2 bases	seats 6

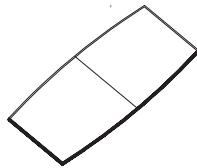

boat

264" x 60"	4 bases	seats 24
240" x 60"	4 bases	seats 22
216" x 60"	4 bases	seats 20
192" x 60"	3 bases	seats 18
264" x 54"	4 bases	seats 22
240" x 54"	4 bases	seats 20
216" x 54"	4 bases	seats 18
192" x 54"	3 bases	seats 16
264" x 48"	4 bases	seats 22
240" x 48"	4 bases	seats 20
216" x 48"	4 bases	seats 18
192" x 48"	3 bases	seats 16
168" x 48"	3 bases	seats 14
144" x 48"	3 bases	seats 12
120" x 48"	2-3* bases	seats 8
120" x 42"	2-3* bases	seats 8
108" x 42"	2 bases	seats 8
96" x 48"	2 bases	seats 8
96" x 42"	2 bases	seats 8
84" x 42"	2 bases	seats 8
72" x 36"	2 bases	seats 6



round*

60" dia.	Seats 6
54" dia.	Seats 6
48" dia.	Seats 4
42" dia.	Seats 4
36" dia.	Seats 4

*requires 1 base

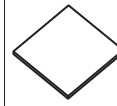

square*

60" sq.	seats 8
54" sq.	seats 6
48" sq.	seats 4
42" sq.	seats 4
36" sq.	seats 4
30" sq.	seats 4

*requires 1 base

* When ordering bases for 120" x 48" and 120" x 42" size tops, three (3) bases are required for Panel and Rectangle bases, two (2) bases are required for all other.

Base (units with access panel in the base for wire management are available, order this feature with the appropriate model number.)

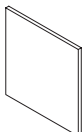

panel base
30" and 24" w

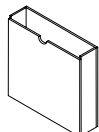

rectangle base
30" and 24" w

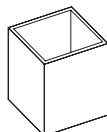

square base
24" and 18" w

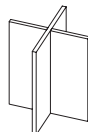

cross base
24" and 18" w

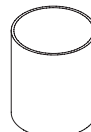

round base
24", 20" and 18" dia.



half-round base
24", 20" and 18" dia.

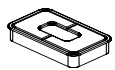

Worksurface Grommet: Additional worksurface grommets can be specified on veneer/laminate worksurfaces. The grommet location must be approved by JSI manufacturing, contact Customer Service. Add upcharge to the list for each additional grommet.

Grommet color must be specified, select Matte Black or Stardust Silver. Lock cores will match grommet color Matte Black (MBK) or Stardust Silver (STS).



End/Back Panel Grommet: The end/back panel grommets are standard, for any special consideration contact Customer Service.



Finale Conference Product Information:

Finish and Reference Codes - Summary

Select	Code
Essentials Veneer Collection	
Brickdust	BRK
Cask	CSK
Clay	CLY
Flax	FLX
Mesa	MES
Mocha	MCH
Outback	OBK
Pilsner	PIL
Sienna	SIE
Truffle	TRF
Umber	UMB

Essentials Veneer with Laminate Top

Brickdust	BRK
Cask	CSK
Clay	CLY
Mesa	MES
Mocha	MCH
Outback	OBK
Pilsner	PIL
Umber	UMB

Select	Code
Edge Profile	
Bevel	B
Eased	R4
Gael	G
Reeded	H
Transitional	C
Triad	F

Pull Style and Color

Arc - Matte Black	MBK
Arc - Matte Silver	MSL
Block - Matte Nickel	MNK
Curve - Matte Nickel	MNK
Twist - Matte Nickel	MNK

Grommet Color

Matte Black	MBK
Stardust Silver	STS

Metal Color

Black Sandtex	BSX
Soft Nickel	SNK
Stardust Silver	STS

Glass Color

Clear Glass
White Back Painted