

BeSPACE Lounge Order Check List:

1 Model Number

2 Wood Species

Rift Cut White Oak (WK4) or Flat Cut Walnut (WA1)

3 Wood Finish Options

CLK Clear on Rift Cut White Oak
 CLW Clear on Flat Cut Walnut

4 Door or Drawer Front Optional Paint Color

Paint Color

BKD Backdrop	CHT Chatroom	NWH Nonchalant White	STM Storm
BFX Black Fox	GAL Gale Force	SVP Silverplate	TRC Tricorn Black
BWH Bright White	GRV Greek Villa	SKS Skyline Steel	UKH Universal Khaki

5 Metal Leg Color

Color Options

ASL Arctic Silver	GLD Gold	PEW Pewter	SNK Soft Nickel
ABZ Aged Bronze	MBK Matte Black	SBZ Soft Bronze	

6 Fabric Selection

Please supply the following:

- Fabric vendor/Pattern name/Pattern color
[View all JSI Standard and Graded-In Textiles](#)
- Indicate direction of fabric - Railroaded or Up the Roll
 - Please provide illustration, if available

All COM orders must include the following:

- Vendor's name, pattern name and color
- Sample of the fabric attached to the order
- Model numbers of items for fabric application
- Special application instructions
- Customer and purchase order number

Ship prepaid COM material to:

JSI
 Attn: COM Department
 201 East Martin Street
 Receiving B, Dock 71
 Orleans, IN 47452

Application of fabric:

Railroaded Up the Roll

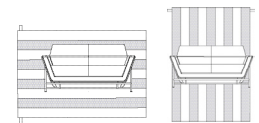

All COM orders will ship at standard lead time from receipt of COM except for orders requiring special custom matched finishes.

7 Glass Door

GTC01 Clear
 GTC04 Silver

8 Optional Power Center

Specify color and location

9 Optional Black Grommet

BeSPACE Specifications

Glass Tables

Glass Tops are 1/2" thick tempered and are available in Clear (low iron) or Smoke. Pliable polyurethane bumpers, along with the weight of the top, keeps the glass in place.

Clear GTC01
Smoke GTC04

Optional Data/Electrical Components

EC22 Power Center- Flush Mount

EC22 unit provides electric for two 110 devices and one USB 2-Port Simplex for charging. This factory installed unit is mounted in the front or back panel(s) of modular closed tables. When ordering specify color and location, see below. Power is connected to the building supply with 10' standard three prong cord. Access and storage of excess power cord is provided in the cavity of the tables.

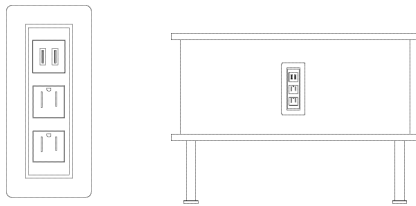

Note: Power Center color, Black (B) or White (W) must be specified.

EC21 Power Center - Under Mount

This accessory item features one 110 device and one USB 2-Port Simplex for charging. The EC21 unit is ordered separately and can be mounted on the bottom platform of casegoods and lounge seating, see "Power Center Under Mount".

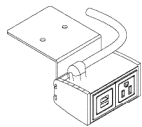

Credenza with Optional Cushions

Bench Height and Transitional Height credenza units can be ordered with an optional factory installed cushion. (Select appropriate fabric grade when pricing the unit). Cushion should not be removed due to permanent attachment.

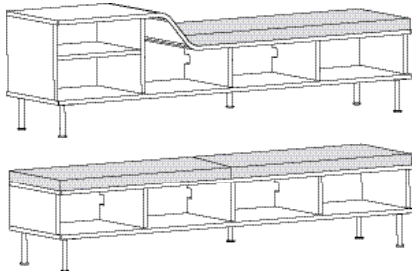

How to determine Left and Right

Left and right is determined by facing the unit; the transitional height unit determines the left or right orientation.

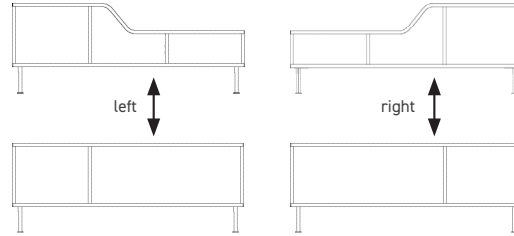

Bookcase Back Heights

Bookcases are available in two heights, 48 and 68 inches tall. When ordering, please specify one of the three back height options; Full Back, Mid Back or Low Back.

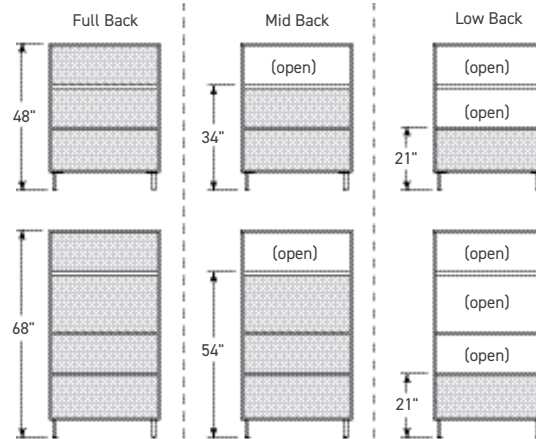

Bookcase Shelving

All bookcase shelves are offered straight as standard. The lowest shelf is always fixed and straight. Upper shelves are adjustable and available with optional bent plywood. The bent plywood shelves are reversible, they can slope in either direction. When ordering bookcases with bent plywood shelves, please specify and add \$890 for one shelf, and \$1,779 for two shelves, to list price.

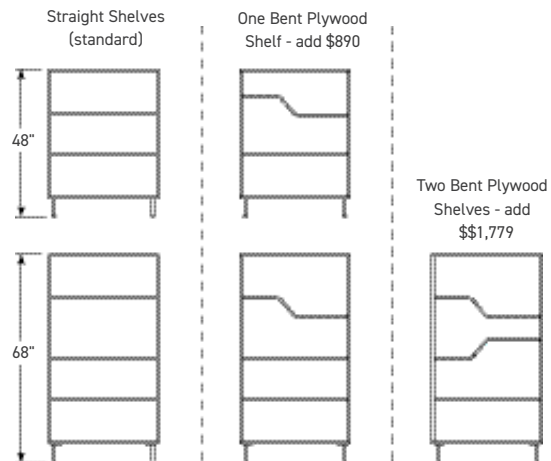

CORPORATE OFFICE
225 CLAY STREET
JASPER, INDIANA 47546



800.457.4511 **TOLL FREE**
812.482.3204 **OFFICE**
812.482.1548 **FAX**



JSIFURNITURE.COM



CONTACT JSI

BeSPACE Specifications

Modular Tables and Modular Lounge - Connecting

1. To create turns with in a product run, connect 120° units with other 120° units or 90° (square end) units with other 90° (square end) units to create turns.

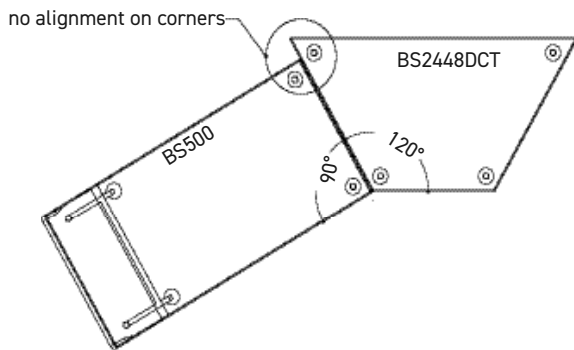
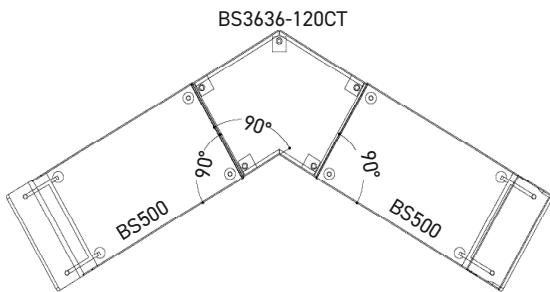
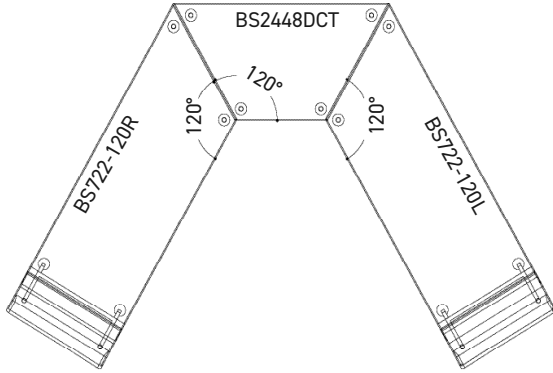

2. For a flat tailored surface corner units will have a seam on the linking side.

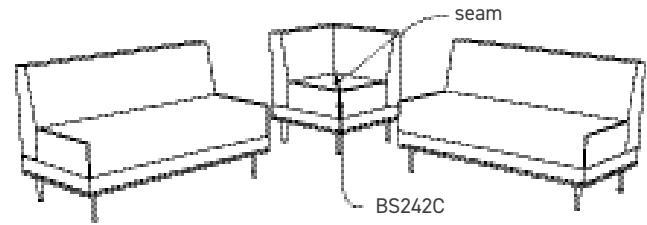
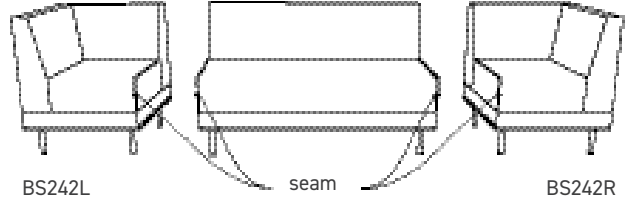

Note: 120° and 90°(square end) units cannot be connected to one another



BeSPACE Specifications

3. When using textiles with a pattern or large repeats we recommend specifying the corner units with "C" at the end of the model number. Note there will be a diagonal seam allowing for a textile match. If the upholstery cover is non-directional the diagonal seam will be eliminate

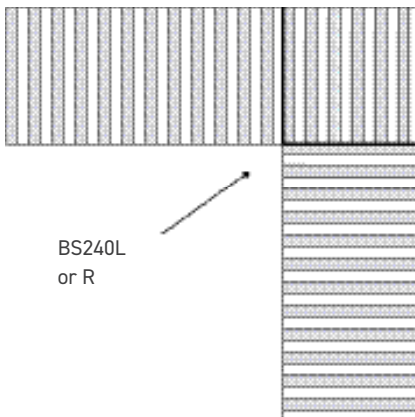
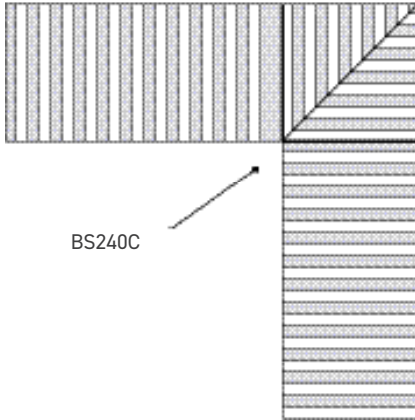

4. Modular tables are shipped with connecting hardware to secure units together. The draw catch style hardware makes connection easy. Pre-bore holes are standard.

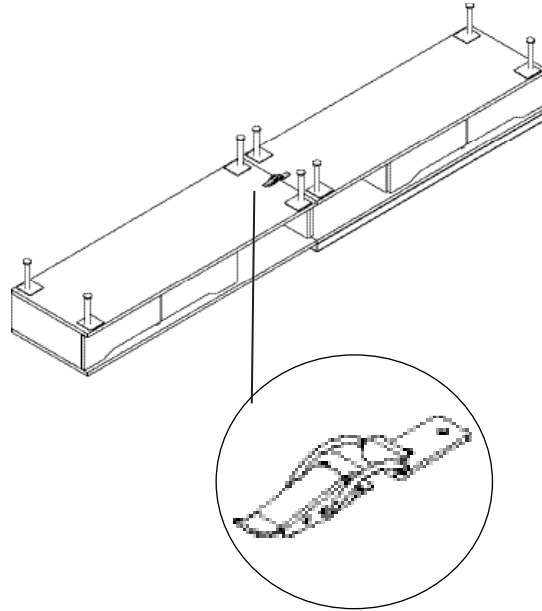

5. Modular lounge units are shipped with two sets of connecting hardware to secure them together. The draw catch style hardware makes connection easy. Pre-bore holes are standard.

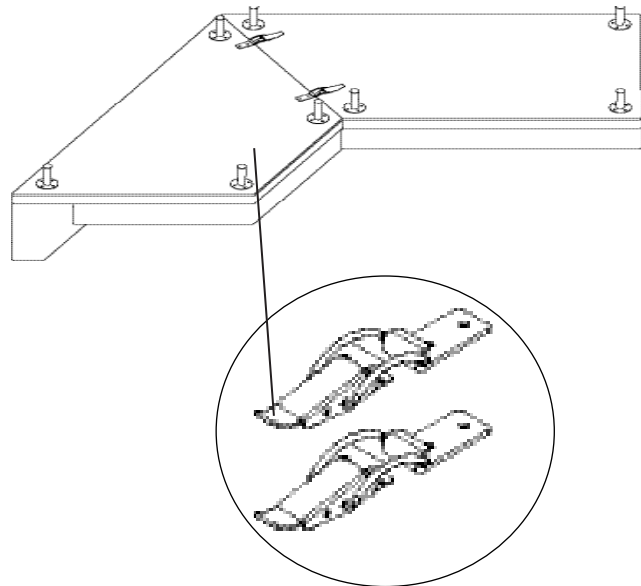

BeSPACE Specifications

Upholstery Application

Unless the customer specifies the fabric to be "railroaded", the fabric will be "cut up the roll". Additional seaming may be needed pending fabric width and textile repeat match, contact Customer Service with questions.

"Nap" or "Up the Roll" (standard)

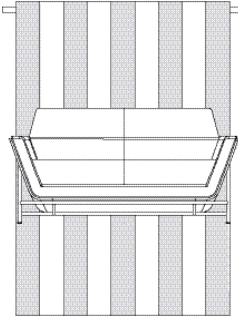

Railroaded (upon request)

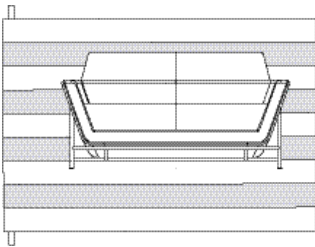

Contrasting Upholstery

BeSPACE offers the ability to be specified with multiply upholsteries to create a unique look. Both upholstery styles are presented in the price list and eTools. Models not ending in a _M will be upholstered in the single upholstery for the complete unit. Models ending with a _M designate multiple upholstery zones will be specified (ex: BS482_M). To calculate pricing, add Base Price + Zone 1 upcharge + Zone 2 Upcharge. When specifying multiple upholstery, make sure to identify specific yardage per zone. This can be found at the top of each product page.

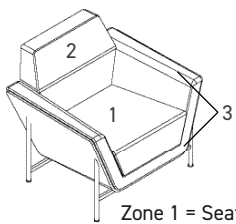

Zone 1 = Seat
Zone 2 = Back
Zone 3 = Deck and Arms

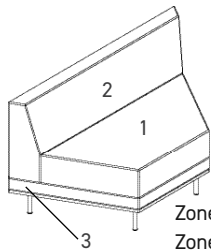

Zone 1 = Seat
Zone 2 = Back
Zone 3 = Deck

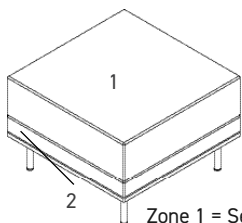

Zone 1 = Seat
Zone 2 = Back

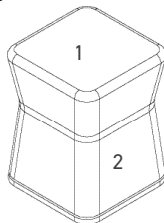

Zone 1 = Seat
Zone 2 = Deck

How to Determine Left and Rights

Left and right is determined as you are seated in the chair.

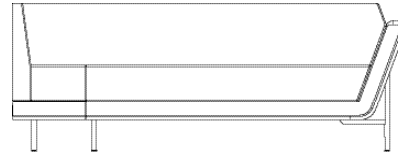

left shown

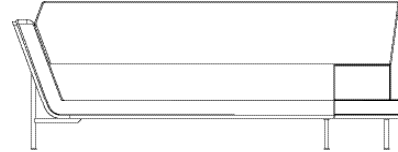

right shown

BS2424DCT Table

This corner table is designed to create a 90° (square end) turn with two modular components as shown in the example below. The "A" or "B" back panels are identified to help specify the location of the EC22 power data unit. When ordering an EC22 specify "A" and/or "B" location. The two back panels are slightly recessed. The grain runs diagonal on the table top.

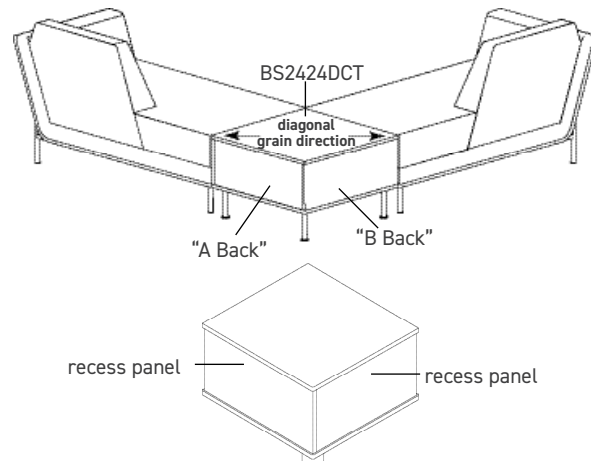

BS2424SCT Table

This table is designed to create a straight run of modular components as shown in the example below. The EC22 can be installed in the front or back panel. The front and back panel are slight recessed. The grain on this top runs side to side.

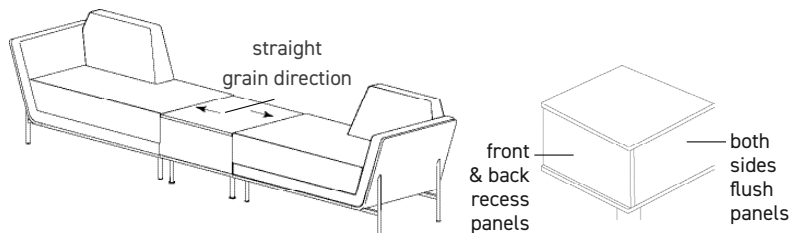

CORPORATE OFFICE
225 CLAY STREET
JASPER, INDIANA 47546



800.457.4511 **TOLL FREE**
812.482.3204 **OFFICE**
812.482.1548 **FAX**



JSIFURNITURE.COM



CONTACT JSI