

Vision Product Information

Veneer

Exterior Wood Materials

Exterior surfaces are made from the finest selected veneers to achieve clarity and consistency in the Vision product line. To attain a pleasing, symmetrical pattern, all cherry, maple, walnut and black oak veneers in Vision are book-matched. All exterior solid lumber is matched to coordinate with the veneer.

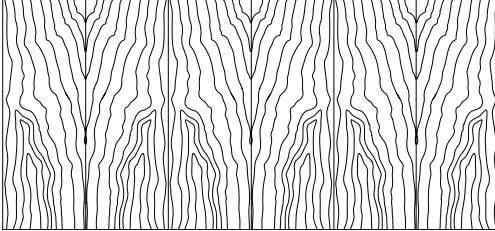

Book-Matched Example

Alternating pieces of veneer are flipped over so they face each other like the pages within a book. Vision is available in flat cut cherry, maple, walnut and black oak veneer. A wide range of wood stains have been formulated to enhance the beauty of the veneer.

Double Cut veneer is another choice on Vision product. This veneer is a processed product that has at least two cuttings to create the final veneers. These cuts of veneer strands are dyed and layered into a block to create variation of patterns from a very tight grain pattern to an exotic figure grain pattern. The diagram below show the tight pattern used on Vision.

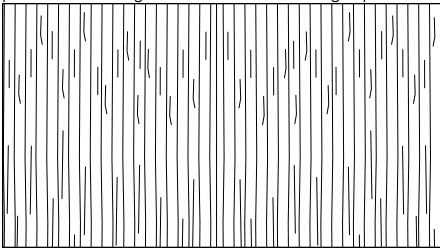

WorkSurface Construction

Flat Cut veneer worksurfaces have a 3-ply balanced construction, Double Cut veneer and Coordinating HPL are 3-ply. The tops are 1 3/16" thick with solid matching hardwood edges. Surfaces are available in wood veneer or high pressure laminate. No additional charge for using our coordinating high pressure laminate with a veneer grain pattern with finish wood edges, see page [V13](#) for available laminate options.

Case Construction

Outside panels are 3/4" and joined together with dowels reinforced with screws, and metal fasteners for increased stability. Tops are secured to the chassis screws through pre-bored stretcher rails and pocket holes.

Cabinet doors have 110° swing hinges to allow adequate access into the interior of the cabinet.

Overhead Construction

Veneer models are unfinished on the back side and fasteners are visible on the back of unit. Laminate models have visible fasteners on the back of unit.

Finish - Stain/Colors

We offer a variety of wood stains on Vision. Please see the chart below. Samples are available upon request.

ESS Essentials Veneer Collection			
BRK	Brickdust	MIN	Mineral
CSK	Cask	MCH	Mocha
CLY	Clay	OBK	Outback
FAW	Fawn	PIL	Pilsner
FLX	Flax	SIE	Sienna
FLN	Flint	TRF	Truffle
LOF	Loft	UMB	Umber
MES	Mesa	VAL	Valley

ART Artisan Veneer Collection			
BAR	Barrel	RAV	Raven
BUF	Buff	RYE	Rye
CND	Cinder	SAB	Sable
EGR	Egret	SAD	Saddle

Protective Top Coat

DuraTex™ offers exceptional hardness along with abrasion and impact resistance, it has been formulated to eliminate hazardous and harmful gases that are normally associated with wood finish.

DuraTex™ Features

Safety - Significantly reduces hazardous formaldehyde emissions which help improve the quality of the of the indoor air we breathe.

Quality - Developed to be tough and durable with special attention to appearance. The DuraTex™ finish preserves the natural beauty of wood. **Durability** - Designed to meet a wide range of demanding performance and environmental standards to withstand even the highest wear and tear.

Finish Sheen

All veneer finishes are standard in 35-sheen, with the exception of Raven. Raven is only offered in 15-sheen. All other finishes are available in 15-sheen, see standard modifications.

Custom/Special Finishes

JSI, upon request, will accommodate special finishes. A written request is required to proceed with custom finish orders. A sample reference is required for first-time matches and must be included with the written request.

There is a one-time charge of \$412 list per order for any non-standard wood finish. Orders will be entered noting the special finish. A sample match will be provided to the customer. Written approval is needed before the finish process can be started. Delays in approval may have an impact on lead times. Every effort will be made to create the requested match; however, an acceptable match may not be possible because of natural variations of wood. These natural variations can also cause minor differences in the final finish product. Use standard pricing and option pricing for each line item with a special finish, unless additional modifications have been specified. For items available in both Essential and Artisan veneers, apply the Essentials pricing.

Wood Species Change

For species changes contact customer service for a quote.



Vision Product Information

Laminate Tops on Veneer Units

Laminate worksurface with wood edge, no additional upcharge if Vision's coordinating wood grain laminate with finished wood edges is specified. Contact Customer Service for any other laminate request. Listed below are finishes that have coordinating wood grain HPL laminates.

ESS	Essentials Veneer		
BRK	Brickdust	MIN	Mineral
CSK	Cask	MCH	Mocha
CLY	Clay	OBK	Outback
FAW	Fawn	PIL	Pilsner
FLN	Flint	UMB	Umber
LOF	Loft	VAL	Valley
MES	Mesa		
ART	Artisan Veneer		
EGR	Egret		

Wood Drawers

Four corner dovetailed wood drawers must be specified at the time of order placement. There is a 10% upcharge added to the list of each item.

Laminates

Vision Laminate features TFL (thermally fused laminate) chassis and components. Main Worksurfaces* are available in a HPL (high pressure laminate) or in the TFL surface.

Edges of the worksurface are impact resistant (PVC) on TFL and HPL tops. The laminate is offered in 19 wood grain patterns and 7 solid colors. The wood grain laminate features an embossed grain to hide finger prints and light scratches. The solid laminate is smooth to the touch with a semi-matte finish. All Vision Laminate products are indoor-air certified by GreenGuard.

The chart below lists the laminates available on the Vision product.

TFL - HPL Wood Grain Pattern Laminates

BEL	Belair	MIN	Mineral
BRK	Brickdust	MCH	Mocha
CSK	Cask	OBK	Outback
CLY	Clay	PIL	Pilsner
EGR	Egret	PIN	Pinnacle Walnut
FAW	Fawn	UMB	Umber
FLN	Flint	VAL	Valley
FLO	Florence Walnut	WLH	Walnut Heights
LOF	Loft	WEA	Weathered Ash
MES	Mesa		

TFL - HPL Solid Laminates

ALB	Alabaster	SHD	Shadow
BLK	Black	SLG	Slate Grey
BBL	Bridal Blanco	ZEN	Zen Grey
DWH	Designer White		

WorkSurfaces

Laminate worksurfaces have a 3-ply balanced construction. Tops are 13/16" thick with coordinating PVC edges. Primary worksurfaces feature 3mm PVC edges on the approach and user sides. Some laminates have a choice of 3 edge profiles, see page VI4. Main Worksurfaces* are offered in TFL or HPL.

Bridge, return, credenza worksurfaces are profiled with a 3mm PVC edge on the user side only. Remaining edges are banded with 1mm PVC which creates a seamless appearance when units are mated end-to-end or back-to-back.

TFL features on Main Worksurfaces*

- fused to the 45 pound density substrate of the top for a durable wear resistant surface
- tops are laminated on both sides
- available in all the wood grain and solid patterns

HPL features on Main Worksurfaces*

- bonded layers create a durable wear resistant surface
- tops are 3-ply balanced construction
- matched to the TFL wood grain and solid patterns

*Main Worksurfaces include tops on desks, standard height credenzas, returns, bridges and transaction tops. Refer to pricing pages to confirm availability.

Case Construction

Panels for chassis consist of a 3/4" thick substrate with TFL surfaces and PVC bands on exposed edges. Pedestals and cabinets are constructed with dowels reinforced with screws, and metal fasteners for increased stability. Tops are secured to the chassis with screws through pre-bored stretcher rails and pocket holes.

Drawers

The unidirectional V- Fold drawer box is a durable miter-fold drawer structure which is glued and doweled. The 1/2" thick drawer sides are wrapped in a high grade maple vinyl, with an attached front. The drawer front is attached to the four sided box. Optional four corner dovetailed wood drawers are available on veneer units. Specify and add 10% per unit.

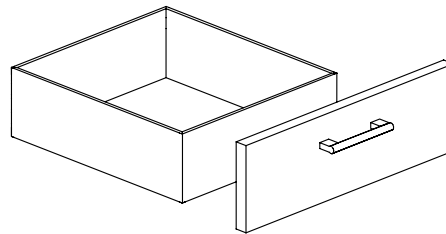

Drawer Suspension

High quality black drawer suspension carries a lifetime warranty. File and box drawers have 100% full extension with over travel. Slides feature steel ball bearings for longer wear and positive, cushioned in/out stops.

Filing Hardware

All file drawers are constructed with a custom designed filing system for hanging folders.



Vision Product Information

Locking

All desks, returns, credenzas, lateral files and storage towers offer optional pedestal front locking to provide maximum security and flexibility in configuration. Up-charge applies.

When locks are ordered, units are shipped randomly keyed. Key alike units are available upon request for no additional charges. Removable cores for in-field re-keying are standard.

Lock face color is controlled by the metal color of the unit.
Pewter and Matte Black - Black Lock Face
Soft Nickel and Arctic Silver - Silver Lock Face

Pedestal Configuration Change

Single pedestal desks have one box/box/file pedestal. Double pedestal desks have a box/box/file pedestal on the left side and file/file pedestal on the right side. Returns are configured with either file/file or box/box/file pedestals. Credenzas are configured with file/file pedestals.

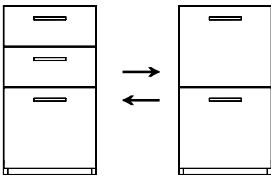

Drawer configurations on fixed height units can be changed from either a box/box/file or a file/file configuration, on units 30”h, but must be specified at the time of order. An additional \$206 upcharge per pedestal needs to be added to the list price of the unit. (Must keep the same pedestal depth.)

Special Construction

Vision offers large offering to create many types of configuration. Contact Customer Service if you are having trouble with finding the right units to complete the desired configuration. Requests need to be approved by JSI engineering.



CORPORATE OFFICE
225 CLAY STREET
JASPER, INDIANA 47546



800.457.4511 **TOLL FREE**
812.482.3204 **OFFICE**
812.482.1548 **FAX**



JSIFURNITURE.COM



CONTACT JSI

Vision Product Information

Top Edge Profile

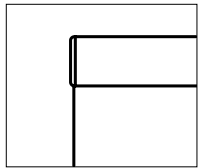

Eased (R3)

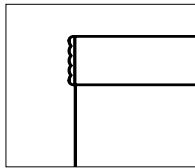

Reeded (H3)

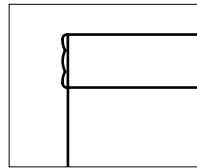

Transitional (C3)

These veneer finishes are available in all three edges:
Brickdust, Cask, Clay, Flax, Flint, Loft, Mesa, Mocha, Outback, Pilsner, Raven, Sienna, Truffle and Umber

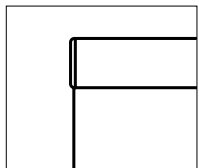

Eased (R3)

All laminates and select veneer finish units are only available with the Eased edge:
Fawn, Mineral, Valley, Barrel, Buff, Cinder, Egret, Rye, Sable and Saddle.

Top Edge Detail Location



desk



bow cockpit desk

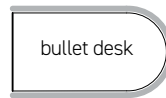

bullet desk



bridge return



P desk



sweeping desk

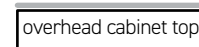

overhead cabinet top



transaction top

— = edge detail
— = flat edge



credenza freestanding lateral

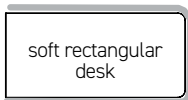

soft rectangular desk

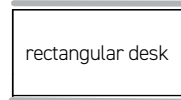

rectangular desk

Approach View of Pedestal Desk

Vision offers two distinct approach views for desks. Specify a model with either a break front modesty or a recessed modesty. Desk model numbers ending in "F" have the full recessed modesty panel.

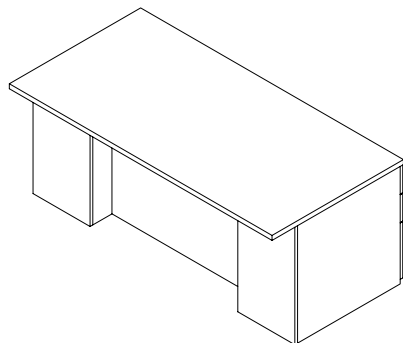

Break Front (model # VST3672DD)

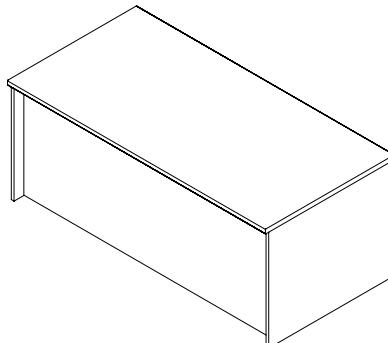

Recessed Front Modesty (model # VST3672DDF)



CORPORATE OFFICE
225 CLAY STREET
JASPER, INDIANA 47546



800.457.4511 **TOLL FREE**
812.482.3204 **OFFICE**
812.482.1548 **FAX**



JSIFURNITURE.COM



CONTACT JSI

Vision Product Information

Pull and Color Options

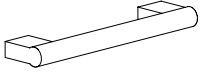

Bar
 Matte Black MBK
 Polished Nickel PNK



Sweep
 Matte Black MBK
 Matte Nickel MNK

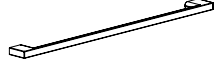

Delve
Standard
 ABZ Aged Bronze
 ASL Arctic Silver
 BWH Bright White
 CHR Chrome
 GLD Gold
 MBK Matte Black
 PEW Pewter
 SBZ Soft Bronze
 SNK Soft Nickel



Prospect
Upcharge

ANL	Antique Linen	EMC	Emerald City	SPP	Sparkling Peach
BLG	Blue Jean	EVP	Evergreen Pine	SPR	Spiced Raisin
CAP	Candy Apple	GOH	Golden Honey	SMK	Stormy Sky
CAB	Cashmere Beige	MWH	Midnight Whisper	TFB	Toffee Brown
CDU	Copper Dust	MUS	Mustard Seed	VMA	Vintage Mahogany
DST	Desert Stone	OLV	Olive Fog		
DUP	Dusty Petal	POW	Porcelain White		
EBL	Electric Blue	SPA	Space Cadet		

Pull Alignment

Bar, Sweep and Delve pulls are mounted on the front of drawer/door. Prospect pull overlays the top of the drawer and door front.

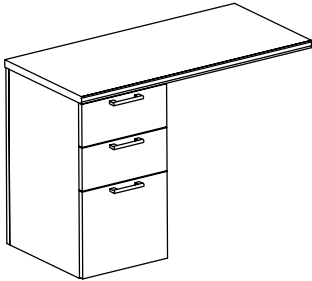

Standard Pull Placement
Bar

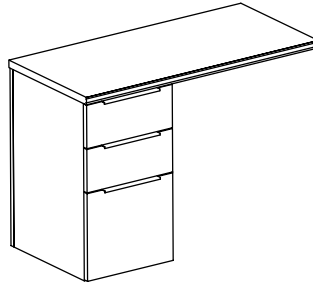

Prospect

Pull Alignment

Bar and Sweep pulls are standard in one length for every application. Delve and Prospect pulls offer an enhanced aesthetic on lateral files and vertical storage, replacing one or two standard pulls with an elongated version. In these cases, the longer pull is used in appropriate application - user need not specify.

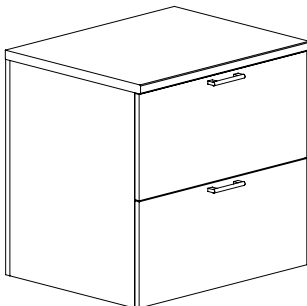

Bar and Sweep Pull
(Bar shown)

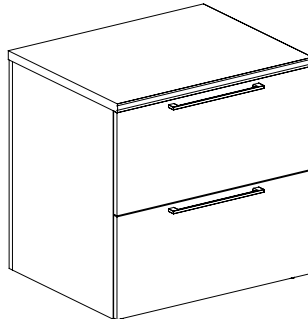

Delve

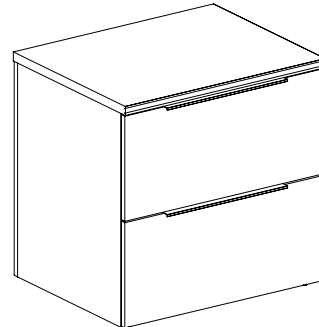

Prospect



Vision Product Information

Chassis End/Back Panel Grommet

Chassis grommets, consisting of back and end panels, are available in Matte Black (MBK) or Arctic Silver (ASL). Due to the nature of wire management, grommets are selected for the complete chassis. Upcharge varies per model and is indicated on pricing pages.

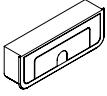

Arctic Silver (ASL)
Matte Black (MBK)

Chassis Grommet Locations

Vision offers optional grommets for wiring to pass thru the unit.

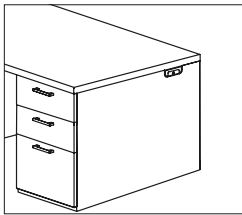

Desks - Credenza
End Panel Grommet

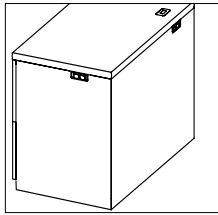

Returns
Work Surface Grommet
End Panel Grommet
Back Panel Grommet

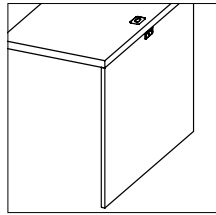

Bridge
Work Surface Grommet
Back Panel Grommet

Worksurface Grommet

Standard worksurface grommet are indicated on specific model add \$58 list per location. For custom locations, contact customer service for approval of location and add \$127 list per location.

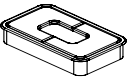

Arctic Silver (ASL)
Matte Black (MBK)

Standard Worksurface Grommet Locations

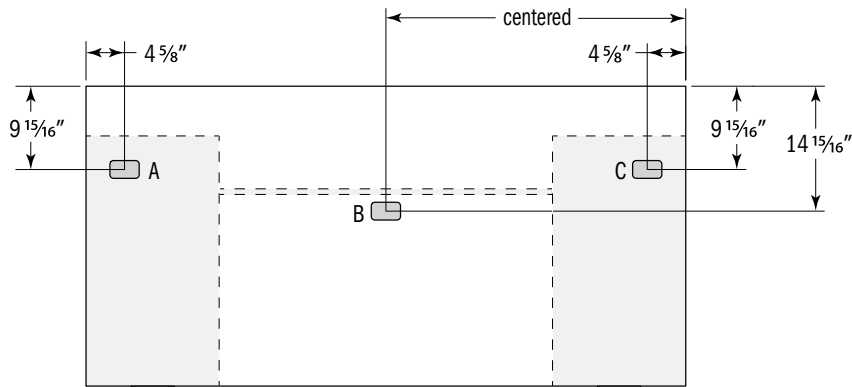

Desks with Overhangs



CORPORATE OFFICE
225 CLAY STREET
JASPER, INDIANA 47546



800.457.4511 **TOLL FREE**
812.482.3204 **OFFICE**
812.482.1548 **FAX**



JSIFURNITURE.COM



CONTACT JSI

Vision Product Information

Worksurface Grommet Locations (continued)

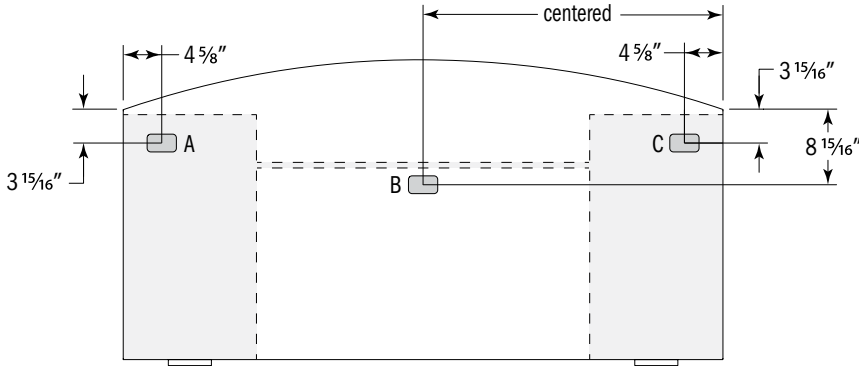

Desks without Overhangs (Bow Front Shown)

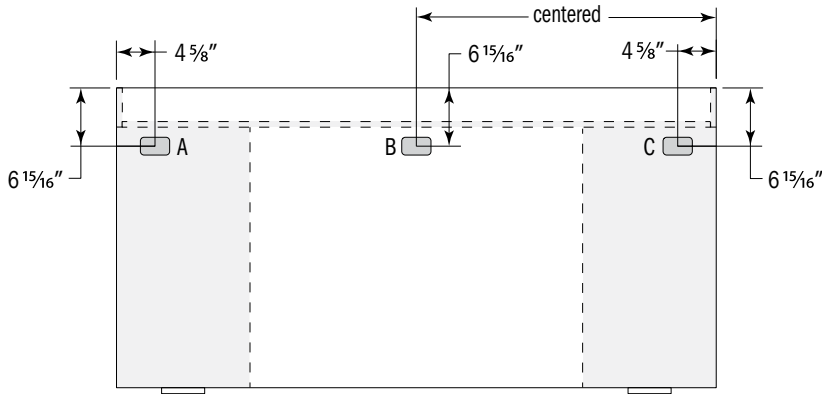

Desks with Recessed Modesty

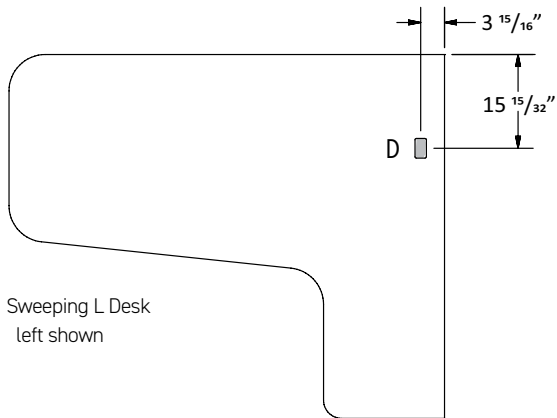

Sweeping L Desk
left shown

Vision Product Information

Worksurface Grommet Locations (continued)

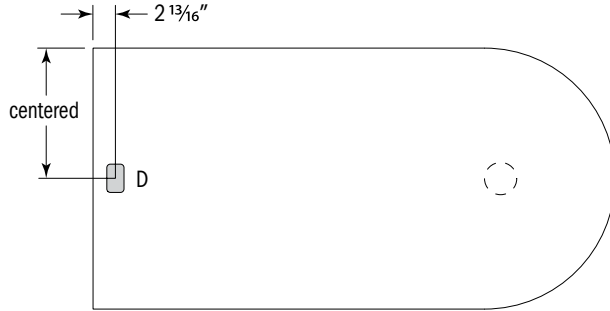

Support End and Run-Off Desks

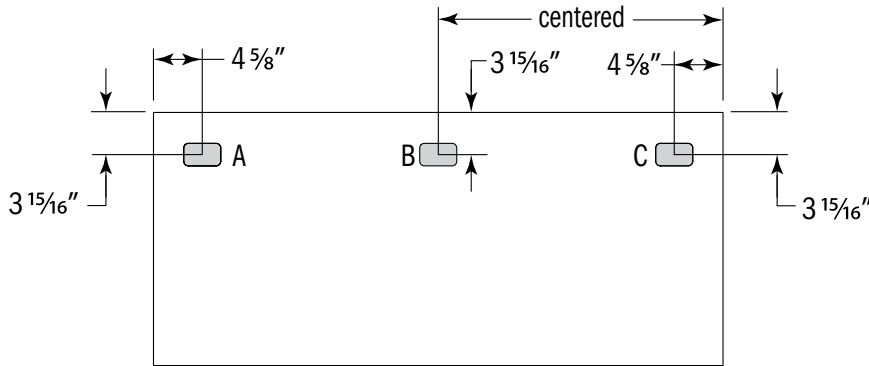

Bridges and Returns

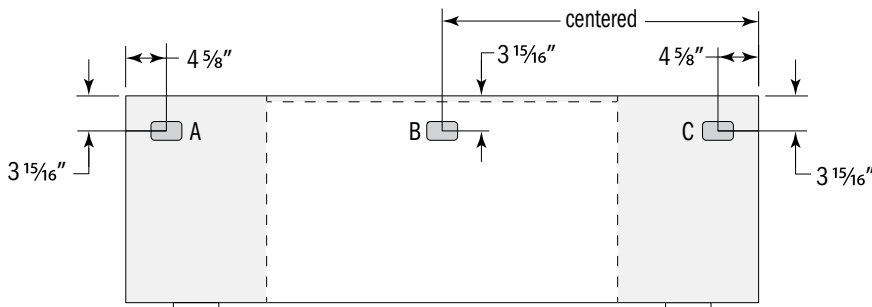

Credenzas

Vision Product Information

Wire Management

Wiring can move freely from unit to unit and out to the building power/data through numerous grommet options.

Optional top grommets are offered in key locations on desks, bridges, returns, credenzas and corner units.

Pedestal desks, credenzas, corners units, bridge panels, return modesty panels and end panels offer optional chassis grommets.

The end panel grommet opening is 4" wide by 1 7/16" high with a bezel trim secured to the panel with a friction side cap.

Refer to the accessory section for additional technology and accessory items. (see page VS322)

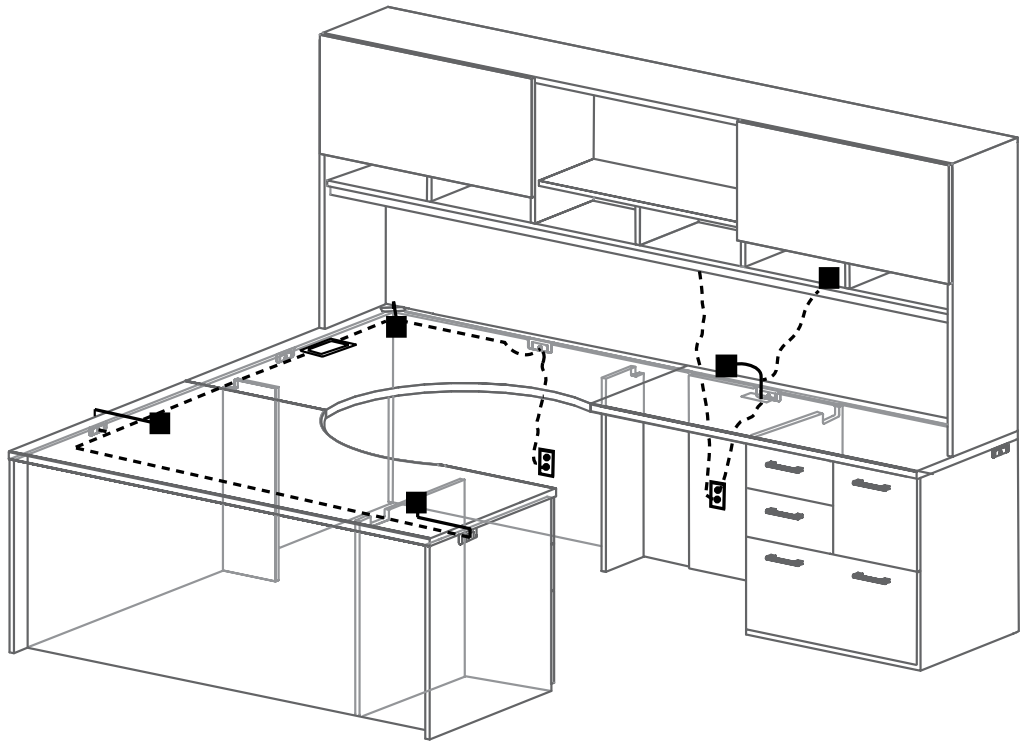

Vision Product Information

Overhead Cabinets, Storage Towers and Wall Mounted Cabinet Door Style

Vision overhead cabinets, storage towers and wall mounted cabinet doors can be specified in laminate door, laminate with aluminum frame glass door, veneer door, veneer aluminum frame glass door, and veneer wood frame glass door.

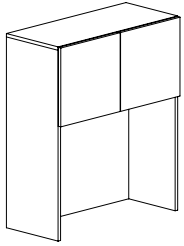

Laminate Cabinet with Laminate Door

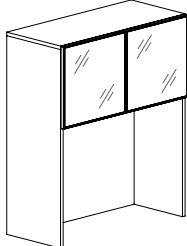

Laminate Cabinet with Aluminum Frame Glass Door

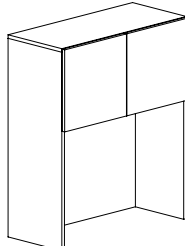

Veneer Cabinet with Veneer or Laminate Door

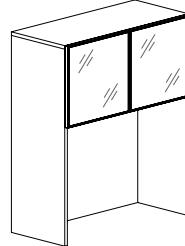

Veneer Cabinet with Aluminum Frame Glass Door

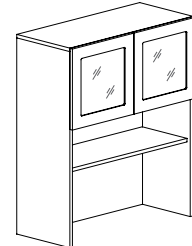

Veneer Cabinet with Wood Frame Glass Door

Door Options for Overhead Cabinets, Storage Towers and Wall Mounted Cabinets

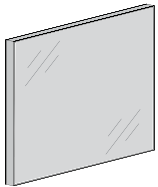

Frosted Aluminum Frame
(Frosted glass with acid etched back)
locking not available

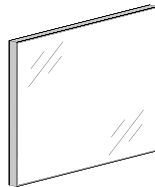

White Back Painted Aluminum Frame
(Glossy low iron white back painted glass)
locking not available

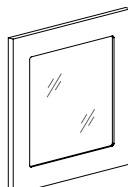

Wood Frame Clear Glass
locking not available

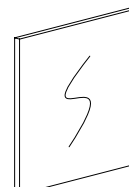

Markerboard

Product Features and Options

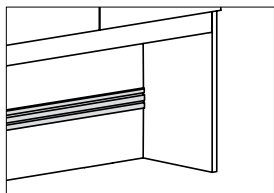

- Aluminum Accessory Rail**
- Anodized Aluminum finish
 - Accessory Tools
 - Upright Tray
 - Small Tray
 - Pencil Tray
 - Paper Tray
 - File Hanger

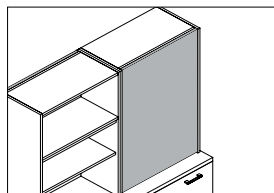

- Fabric Back Panel**
- excellent solution for open plan or room dividers
 - tackable surface
 - COM or JSI fabric program available

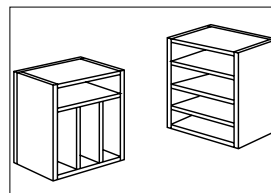

- Paper Sorters**
- Can provide support for transaction worksurfaces
 - Use under overhead cabinet storage overhead cabinets without cubbies
 - Field configured - horizontal shelf and vertical shelves or all horizontal shelves

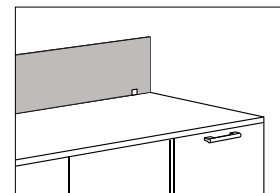

- Privacy Screens**
- Mounts to the top of the worksurface
 - Acrylic Panel - Frosted
 - Attachment hardware is included
 - Field installed



Vision Product Information

Overhead Cabinets + Wall Mount Overheads

Product Overview

Vision overhead cabinets, wall mount overheads and wall panels, when combined with lower storage, create an overall height of 72" or 84". Overhead cabinets are available in two heights: 42 ½" or 54 ½". Wall mount overheads are available in two heights: 17 ½" or 29 ½".

Overhead Cabinets (side view)

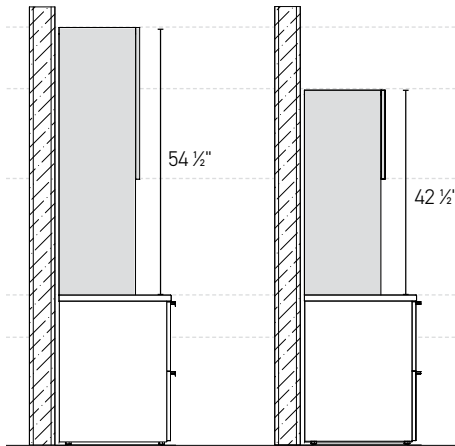

54 ½" overhead cabinet with standard height credenza

42 ½" overhead cabinet with standard height credenza

Wall Mount Overheads (side view)

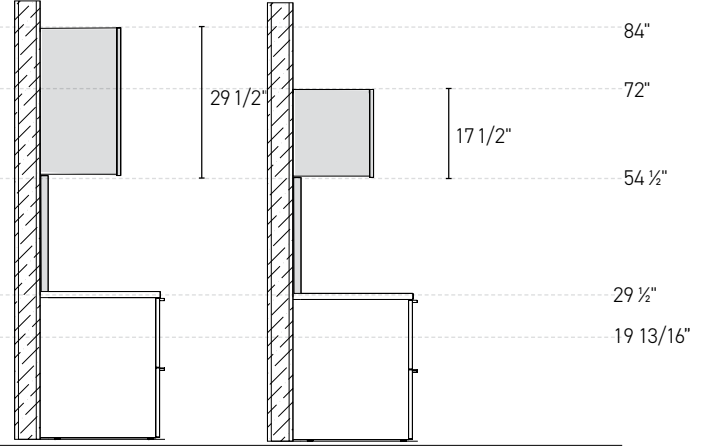

Vision Product Information

Wall Panel Stack-ups

Product Overview

Vision overhead cabinets, wall mount overhangs and wall panels, when combined with lower storage, create an overall height of 72" or 84". Wall panels are available in seven heights to accommodate various combinations of use to create the overall height of 72" or 84". Wall panels are offered in laminate, veneer, tackboard, markerboard, and magnetic glass materials.

Wall Panels with Standard Height Credenza (side view)

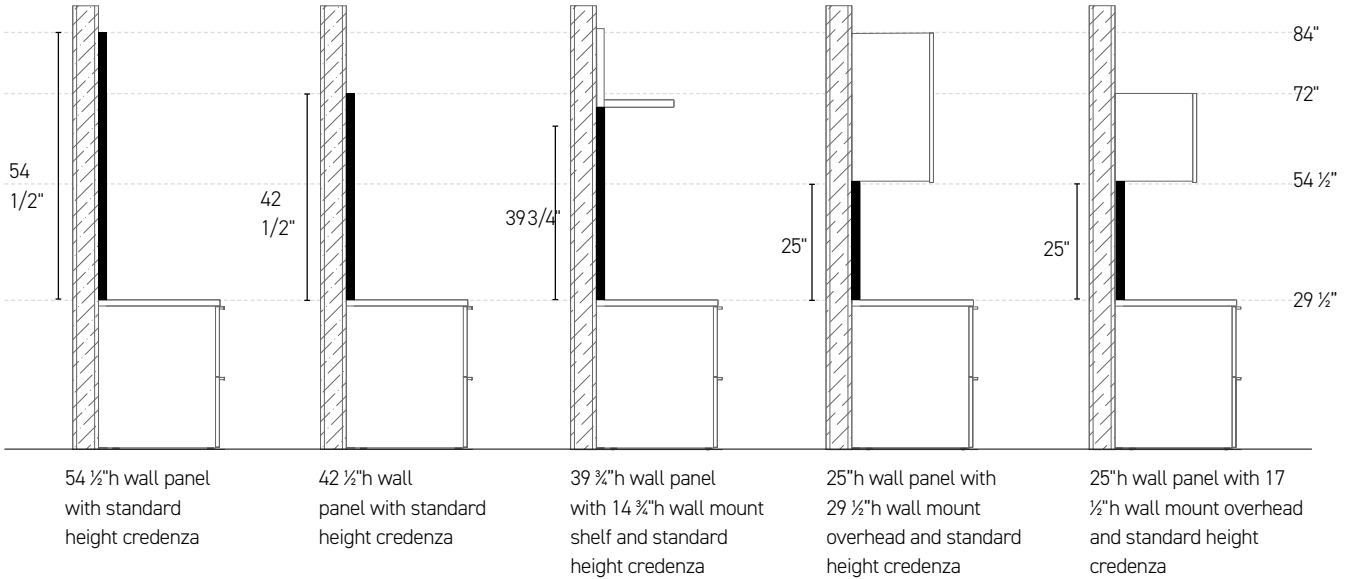

Wall Panels with Bench Height Credenza (side view)

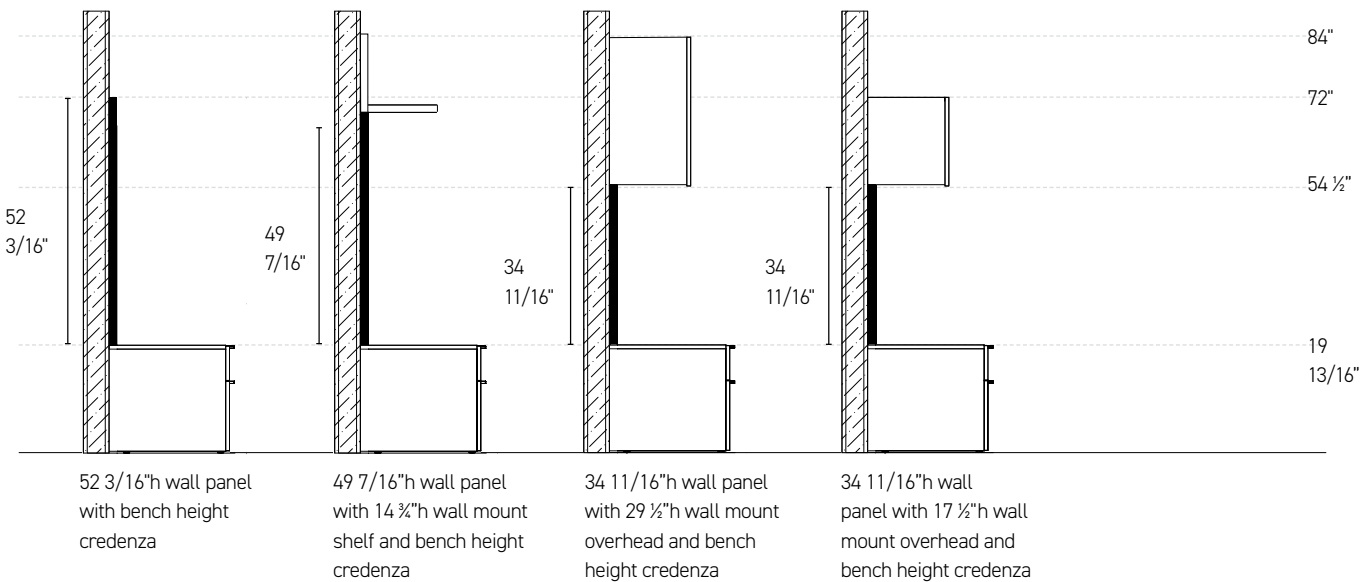

Vision Product Information

Wall Panel Shelf Options - Veneer, Laminate or Glass

54 1/2"h

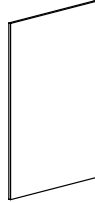
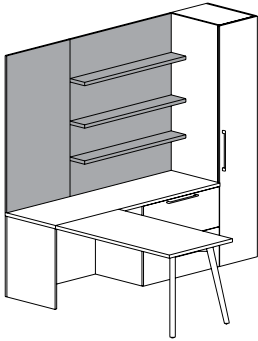

A
No Shelf

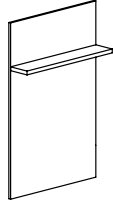

B
Shelf at 69 1/2"

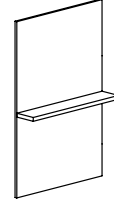

F
Shelf at 54 1/2"

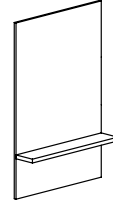

C
Shelf at 42"

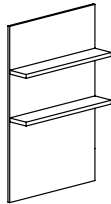

G
Shelf at 69 1/2"
Shelf at 54 1/2"

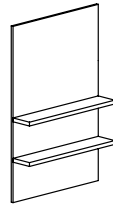

H
Shelf at 54 1/2"
Shelf at 42"

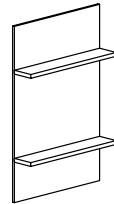

D
Shelf at 69 1/2"
Shelf at 42"

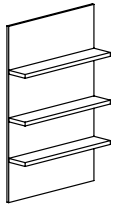

E
Shelf at 69 1/2"
Shelf at 54 1/2"
Shelf at 42"

shelf dimensions are from the floor

52 3/16"h, 49 11/16"h, 42 1/2"h and 39 3/4"h

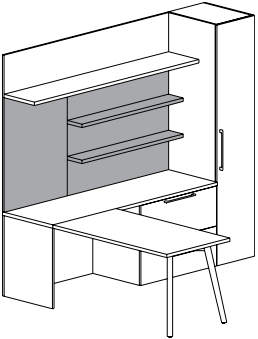

A
No Shelf

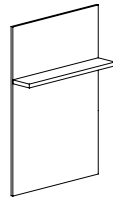

B
Shelf at 54 1/2"

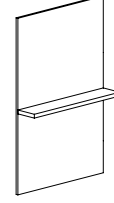

C
Shelf at 42"

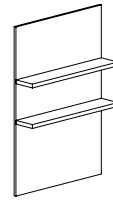

D
Shelf at 54 1/2"
Shelf at 42"

shelf dimensions are from the floor

34 11/16"h and 25"h

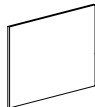
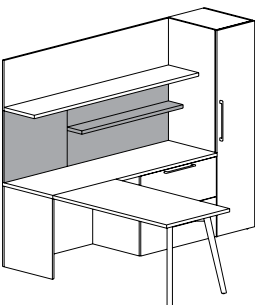

A
No Shelf

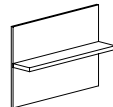

B
Shelf at 42"





Vision Product Information

Wall Panel Ship Weights

Ship weight listed on product pages VS264- VS279 calls out the maximum weight for the most that could be used per model. Listed below are the exact weight per shelf configuration.

Model	Ship Weights for Wall Panels			
	No Shelves	1 Shelf	2 Shelves	3 Shelves
54" Wall Panels with Veneer/Laminate Shelves				
VSV1854WP / VST1854WP	25	29	33	37
VSV2454WP / VST2454WP	32	38	44	50
VSV3054WP / VST3054WP	39	46	53	60
VSV3354WP / VST3354WP	42	50	58	66
VSV3654WP / VST3654WP	45	54	63	72
VSV3954WP / VST3954WP	48	58	68	78
VSV4254WP / VST4254WP	51	62	73	84
VSV4854WP / VST4854WP	58	70	82	94
VSV5454WP / VST5454WP	65	79	93	107
VSV6054WP / VST6054WP	72	87	102	117
53" Wall Panels with Veneer/Laminate Shelves				
VSV1853WP / VST1853WP	23	27	31	
VSV2453WP / VST2453WP	30	36	42	
VSV3053WP / VST3053WP	37	44	51	
VSV3353WP / VST3353WP	40	48	56	
VSV3653WP / VST3653WP	43	52	61	
VSV3953WP / VST3953WP	46	56	66	
VSV4253WP / VST4253WP	49	60	71	
VSV4853WP / VST4853WP	56	68	80	
VSV5453WP / VST5453WP	63	77	91	
VSV6053WP / VST6053WP	70	85	100	
50" Wall Panels with Veneer/Laminate Shelves				
VSV1850WP / VST1850WP	21	25	29	
VSV2450WP / VST2450WP	28	34	40	
VSV3050WP / VST3050WP	35	42	49	
VSV3350WP / VST3350WP	38	46	54	
VSV3650WP / VST3650WP	41	50	59	
VSV3950WP / VST3950WP	44	54	64	
VSV4250WP / VST4250WP	47	58	69	
VSV4850WP / VST4850WP	54	66	78	
VSV5450WP / VST5450WP	61	75	89	
VSV6050WP / VST6050WP	68	83	98	
42" Wall Panels with Veneer/Laminate Shelves				
VSV1842WP / VST1842WP	19	24	29	
VSV2442WP / VST2442WP	25	31	37	
VSV3042WP / VST3042WP	30	38	46	
VSV3342WP / VST3342WP	33	41	49	
VSV3642WP / VST3642WP	36	45	54	
VSV3942WP / VST3942WP	39	48	56	
VSV4242WP / VST4242WP	42	51	60	
VSV4842WP / VST4842WP	47	59	70	
VSV5442WP / VST5442WP	53	64	78	
VSV6042WP / VST6042WP	59	73	87	

Model	Ship Weights for Wall Panels		
	No Shelves	1 Shelf	2 Shelves
40" Wall Panels with Veneer/Laminate Shelves			
VSV1840WP / VST1840WP	18	23	28
VSV2440WP / VST2440WP	23	29	35
VSV3040WP / VST3040WP	29	36	43
VSV3340WP / VST3340WP	31	39	47
VSV3640WP / VST3640WP	34	43	52
VSV3940WP / VST3940WP	37	46	55
VSV4240WP / VST4240WP	39	49	59
VSV4840WP / VST4840WP	44	56	68
VSV5440WP / VST5440WP	50	62	74
VSV6040WP / VST6040WP	55	67	79
35" Wall Panels with Veneer/Laminate Shelves			
VSV1835WP / VST1835WP	16	21	
VSV2435WP / VST2435WP	21	27	
VSV3035WP / VST3035WP	25	33	
VSV3335WP / VST3335WP	28	36	
VSV3635WP / VST3635WP	30	38	
VSV3935WP / VST3935WP	32	42	
VSV4235WP / VST4235WP	35	45	
VSV4835WP / VST4835WP	40	50	
VSV5435WP / VST5435WP	44	56	
VSV6035WP / VST6035WP	48	62	
25" Wall Panels with Veneer/Laminate Shelves			
VSV1825WP / VST1825WP	13	17	
VSV2425WP / VST2425WP	16	22	
VSV3025WP / VST3025WP	19	27	
VSV3325WP / VST3325WP	21	29	
VSV3625WP / VST3625WP	23	31	
VSV3925WP / VST3925WP	25	33	
VSV4225WP / VST4225WP	27	35	
VSV4825WP / VST4825WP	29	40	
VSV5425WP / VST5425WP	33	45	
VSV6025WP / VST6025WP	37	50	



Vision Product Information

Wall Panel Ship Weights

Ship weight listed on product pages VS264- VS279 calls out the maximum weight for the most that could be used per model. Listed below are the exact weight per shelf configuration.

Ship Weights for Wall Panels			
Model	1 Shelf	2 Shelves	3 Shelves
54" h Wall Panels with Glass Shelves			
VSV1854WPGS / VST1854WPGS	28	31	34
VSV2454WPGS / VST2454WPGS	36	40	44
VSV3054WPGS / VST3054WPGS	44	49	54
VSV3354WPGS / VST3354WPGS	47	52	57
VSV3654WPGS / VST3654WPGS	51	57	63
VSV3954WPGS / VST3954WPGS	54	60	66
VSV4254WPGS / VST4254WPGS	58	65	72
VSV4854WPGS / VST4854WPGS	66	74	82
VSV5454WPGS / VST5454WPGS	74	83	92
VSV6054WPGS / VST6054WPGS	82	92	102
53" h Wall Panels with Glass Shelves			
VSV1853WPGS / VST1853WPGS	26	29	
VSV2453WPGS / VST2453WPGS	34	38	
VSV3053WPGS / VST3053WPGS	42	47	
VSV3353WPGS / VST3353WPGS	45	50	
VSV3653WPGS / VST3653WPGS	49	55	
VSV3953WPGS / VST3953WPGS	52	58	
VSV4253WPGS / VST4253WPGS	56	63	
VSV4853WPGS / VST4853WPGS	64	72	
VSV5453WPGS / VST5453WPGS	72	81	
VSV6053WPGS / VST6053WPGS	80	90	
50" h Wall Panels with Glass Shelves			
VSV1850WPGS / VST1850WPGS	24	27	
VSV2450WPGS / VST2450WPGS	32	36	
VSV3050WPGS / VST3050WPGS	40	45	
VSV3350WPGS / VST3350WPGS	43	48	
VSV3650WPGS / VST3650WPGS	47	53	
VSV3950WPGS / VST3950WPGS	50	56	
VSV4250WPGS / VST4250WPGS	54	61	
VSV4850WPGS / VST4850WPGS	62	70	
VSV5450WPGS / VST5450WPGS	70	79	
VSV6050WPGS / VST6050WPGS	78	88	
42" h Wall Panels with Glass Shelves			
VSV1842WPGS / VST1842WPGS	22	25	
VSV2442WPGS / VST2442WPGS	29	33	
VSV3042WPGS / VST3042WPGS	35	40	
VSV3342WPGS / VST3342WPGS	38	43	
VSV3642WPGS / VST3642WPGS	42	48	
VSV3942WPGS / VST3942WPGS	45	51	
VSV4242WPGS / VST4242WPGS	49	56	
VSV4842WPGS / VST4842WPGS	55	63	
VSV5442WPGS / VST5442WPGS	62	71	
VSV6042WPGS / VST6042WPGS	69	79	

Ship Weights for Wall Panels		
Model	1 Shelf	2 Shelves
40" h Wall Panels with Glass Shelves		
VSV1840WPGS / VST1840WPGS	21	24
VSV2440WPGS / VST2440WPGS	27	31
VSV3040WPGS / VST3040WPGS	34	39
VSV3340WPGS / VST3340WPGS	36	41
VSV3640WPGS / VST3640WPGS	40	46
VSV3940WPGS / VST3940WPGS	43	49
VSV4240WPGS / VST4240WPGS	46	53
VSV4840WPGS / VST4840WPGS	52	60
VSV5440WPGS / VST5440WPGS	59	68
VSV6040WPGS / VST6040WPGS	65	75
35" h Wall Panels with Glass Shelf		
VSV1835WPGS / VST1835WPGS	19	
VSV2435WPGS / VST2435WPGS	25	
VSV3035WPGS / VST3035WPGS	30	
VSV3335WPGS / VST3335WPGS	33	
VSV3635WPGS / VST3635WPGS	36	
VSV3935WPGS / VST3935WPGS	38	
VSV4235WPGS / VST4235WPGS	42	
VSV4835WPGS / VST4835WPGS	48	
VSV5435WPGS / VST5435WPGS	53	
VSV6035WPGS / VST6035WPGS	58	
25" h Wall Panels with Glass Shelf		
VSV1825WPGS / VST1825WPGS	16	
VSV2425WPGS / VST2425WPGS	20	
VSV3025WPGS / VST3025WPGS	24	
VSV3325WPGS / VST3325WPGS	26	
VSV3625WPGS / VST3625WPGS	29	
VSV3925WPGS / VST3925WPGS	31	
VSV4225WPGS / VST4225WPGS	34	
VSV4825WPGS / VST4825WPGS	37	
VSV5425WPGS / VST5425WPGS	42	
VSV6025WPGS / VST6025WPGS	47	



Vision Product Information

Vision integrates height adjustability into the workplace environment in multiple ways to meet the unique needs of the customer. Here is an overview of the most popular ways.

Adjustable Height T-Base Table Desks

Tables with exposed telescoping legs is offered in Standard and Extended Range with electrical units. Select units also offer Pneumatic.

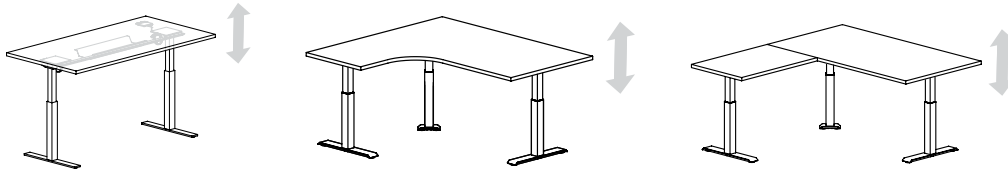

Adjustable Height Cantilever

Creates a statement piece when using the Cantilevered Table and Support Credenza together.

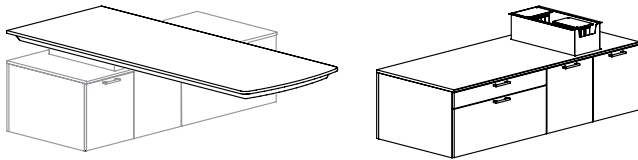

Use with Cantilever Support Credenza

Adjustable Height Single Pedestal Desk

Single pedestal adjustable desks can be used with companion fixed bridge or return to eliminate pinch points.

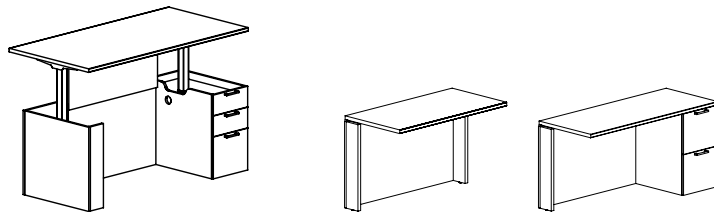

Use with Fixed Bridge or Return

Adjustable Height Bridge and Return

For applications when desk is stationary and height adjustability is needed on the bridge or return. Units created to eliminate pinch points.

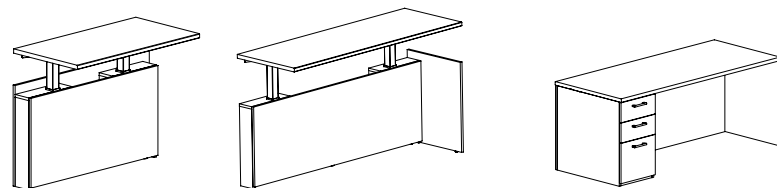

Use with Fixed Height Desk

Vision Product Information

Adjustable Height Desk

Stand alone height adjustable table encapsulates mechanism within end panels.

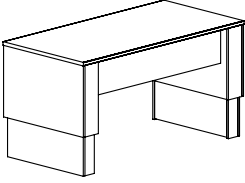

With Telescoping End Panels

Adjustable Height Peninsula Desk

Use with bench height configurations for smaller footprints when adjustability needed at desk.

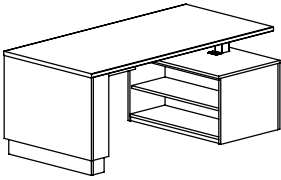

With Telescoping End Panel and Credenza

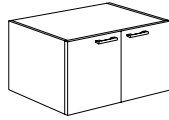

Use with Bench Height Configurations

Use with workwall peninsula desk for height adjustability on bridge or return.

Adjustable Height Workwall Bridge

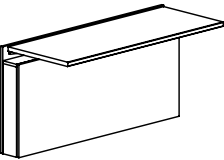

Adjustable Height Workwall Return

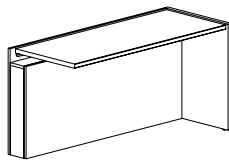

Adjustable Height Workwall Credenza

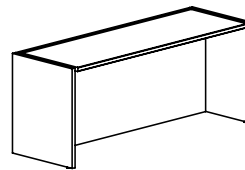

Vision Product Information

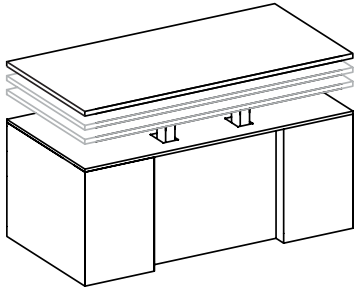

ERGO Adjustable Work Height Mechanism

Our proprietary adjustable work height mechanism can be specified on many of the models in Vision. ERGO can only be specified in a HPL (high pressured laminate) or Veneer.

ERGO mechanism allows height adjustability to be added to the worksurface. Our solution uses a standardized design that minimizes the modifications required to standard desk, bridge, or credenza models. The mechanism and control box are neatly concealed to maintain the appearance of the original elegance of the product. A push button activates the electric powered lifting columns for adjustability from sitting height to a standing height. A3/4" thick finished sub top is added to the top of the desk chassis for a clean appearance when the surface is in the raised position. In the lowered position, please note that ERGO adds 3/4" to the standard height of the desk and the installation will decrease knee space depth by 8".

Automatic Collision Control is built in to each mechanism as a standard feature. When the system senses an obstacle obstructing the movement, the mechanism will reverse direction and retreat by 1".

When ERGO is added to a worksurface in an "L" or "U" group, all units in the configuration need to have a sub top added. These units are considered to be ERGO ADJACENT units. ERGO ADJACENT units must have a fixed height worksurface that matches the lowest position of the ERGO mechanism and the top. This is accomplished by adding a 3/4" sub top between the chassis and the worksurface. This feature can also be specified for cabinets which may sit next to a unit with the ERGO mechanism. Height adjustment starts at 30 3/4", to a standing height of 49 3/4", a range of 19 1/2". NOTE: The kneespace depth is decreased when the ERGO mechanism is specified. Contact Customer Service for dimension information.

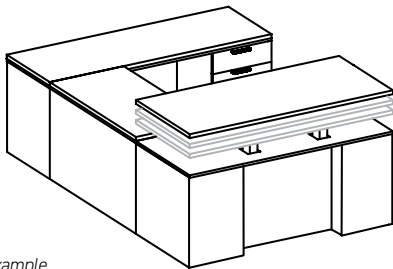

Example

VST3672LD (with ERGO option)
VST2448EB (with ERGO ADJACENT option)
VST2472RC (with ERGO ADJACENT option)

add \$4,777 to list
add \$514 to list
add \$630 to list

VSV3672LD (with ERGO option)
VSV2448EB (with ERGO ADJACENT option)
VSV2472RC (with ERGO ADJACENT option)

add \$5,337 to list
add \$650 to list
add \$786 to list

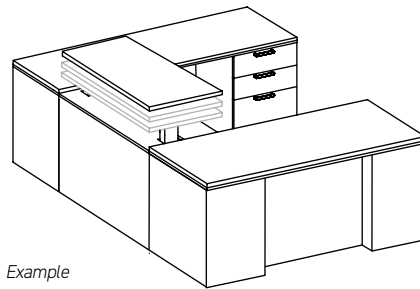

Example

VST3672LD (with ERGO ADJACENT option)
VST2448EB (with ERGO option)
VST2472RC (with ERGO ADJACENT option)

add \$630 to list
add \$4,777 to list
add \$630 to list

VSV3672LD (with ERGO ADJACENT option)
VSV2448E (with ERGO option)
VSV2472RC (with ERGO ADJACENT option)

add \$786 to list
add \$5,337 to list
add \$786 to list

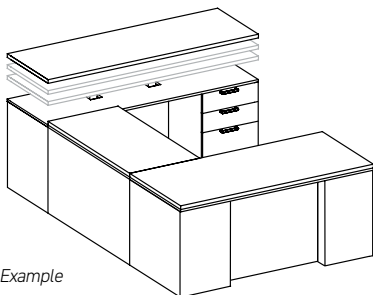

Example

VST3672LD (with ERGO ADJACENT option)
VST2448EB (with ERGO ADJACENT option)
VST2472RC (with ERGO option)

add \$630 to list
add \$514 to list
add \$4,777 to list

VSV3672LD (with ERGO ADJACENT option)
VSV2448EB (with ERGO ADJACENT option)
VSV2472RC (with ERGO option)

add \$786 to list
add \$670 to list
add \$5,337 to list

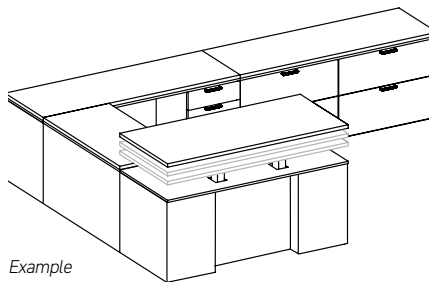

Example

VST3672LD (with ERGO option)
VST2448EB (with ERGO ADJACENT option)
VST2472RC (with ERGO ADJACENT option)
VST2472LFC (with ERGO ADJACENT option)

add \$4,777 to list
add \$514 to list
add \$630 to list
add \$630 to list

VSV3672LD (with ERGO option)
VSV2448EB (with ERGO ADJACENT option)
VSV2472RC (with ERGO ADJACENT option)
VSV2472LFC (with ERGO ADJACENT option)

add \$5,337 to list
add \$670 to list
add \$786 to list
add \$786 to list



Vision Product Information

Availability of Vision HPL Laminate or Veneer Units with the ERGO Mechanism

The following models are available, in HPL or Veneer, with the ERGO Adjustable Work Height Mechanism.

Freestanding Units

Units below do not require adjacent products; select ERGO option for HPL Laminate add \$4,777 or Veneer add \$5,337 to the list price.

Double Pedestal Desks		Credenzas		Shell Desks
VST3060DD	VST3672DDF	VST2060KC	VST2460KC	VST3060SHDF
VSV3060DD	VSV3672DDF	VSV2060KC	VSV2460KC	VSV3060SHDF
VST3060DDF	VST3678DD	VST2066KC	VST2466KC	VST3066SHDF
VSV3060DDF	VSV3678DD	VSV2066KC	VSV2466KC	VSV3066SHDF
VST3066DD	VST3678DDF	VST2072KC	VST2472KC	VST3072SHDF
VSV3066DD	VSV3678DDF	VSV2072KC	VSV2472KC	VSV3072SHDF
VST3066DDF	VST3684BD	VST2078KC	VST2478KC	VST3672SHDF
VSV3066DDF	VSV3684BD	VSV2078KC	VSV2478KC	VSV3672SHDF
VST3072DD	VST3684BDF	VST2084KC	VST2484KC	
VSV3072DD	VSV3684BDF	VSV2084KC	VSV2484KC	
VST3072DDF	VST3684DD			
VSV3072DDF	VSV3684DD			
VST3672BD	VST3684DDF			
VSV3672BD	VSV3684DDF			
VST3672BDF	VST4272BD			
VSV3672BDF	VSV4272BD			
VST3672DD	VST4272BDF			
VSV3672DD	VSV4272BDF			

ERGO Adjacent Connecting

Units Select ERGO option for the model you wish to have height adjustment for HPL Laminate add \$4,777 or Veneer add \$5,337 to the list price. For units, from this list, that are connecting to the ERGO model, you must select ERGO ADJACENT on each of these connecting laminate models add \$630 and veneer add \$786 list price. *If the connecting model is 24" x 48" or less for laminate add \$514 list or veneer add \$670.

Single Pedestal Desks		Returns		Credenzas		Bridges	Corner Units	
VST3066LD	VST3684LD	VST2042ELR*	VST2442ERCR*	VST2460LRR	VST2060LC*	VST2460LC	VST2036EB*	VST4242-20ECU
VSV3066LD	VSV3684LD	VSV2042ELR*	VSV2442ERCR*	VSV2460LRR	VSV2060LC*	VSV2460LC	VSV2036EB*	VSV4242-20ECU
VST3066LDF	VST3684LDF	VST2042ELY*	VST2442ERCY*	VST2460LLR	VST2060RC*	VST2460RC	VST2042EB*	VST4242-24ECU
VSV3066LDF	VSV3684LDF	VSV2042ELY*	VSV2442ERCY*	VSV2460LLR	VSV2060RC*	VSV2460RC	VSV2042EB*	VSV4242-24ECU
VST3066RD	VST3684RBD	VST2042ELR*	VST2442ERR*	VST2454LRR	VST2066LC*	VST2466LC	VST2048EB*	VST4852ERCU
VSV3066RD	VSV3684RBD	VSV2042ELR*	VSV2442ERR*	VSV2454LRR	VSV2066LC*	VSV2466LC	VSV2048EB*	VSV4852ERCU
VST3066RDF	VST3684RBD	VST2042ERY*	VST2442ERY*	VST2454LLR	VST2066RC*	VST2466RC	VST2436EB*	VST4852ELCU
VSV3066RDF	VSV3684RBD	VSV2042ERY*	VSV2442ERY*	VSV2454LLR	VSV2066RC*	VSV2466RC	VSV2436EB*	VSV4852ELCU
VST3072LD	VST3684RD	VST2048ELR*	VST2448ELCR*	VST2448LRR	VST2072LC*	VST2472LC	VST2442EB*	
VSV3072LD	VSV3684RD	VSV2048ELR*	VSV2448ELCR*	VSV2448LRR	VSV2072LC*	VSV2472LC	VSV2442EB*	
VST3072LDF	VST3684RDF	VST2048ELY*	VST2448ELCY*	VST2448LLR	VST2072RC*	VST2472RC	VST2448EB*	
VSV3072LDF	VSV3684RDF	VSV2048ELY*	VSV2448ELCY*	VSV2448LLR	VSV2072RC*	VSV2472RC	VSV2448EB*	
VST3072RD	VST4272CLD	VST2048ERR*	VST2448ELR*	VST2060LRR*	VST2078LC*	VST2478LC		
VSV3072RD	VSV4272CLD	VSV2048ERR*	VSV2448ELR*	VSV2060LRR*	VST2078LC*	VST2478LC		
VST3072RDF	VST4272CLDF	VST2048ERY*	VST2448ELY*	VST2060LLR*	VST2078RC*	VST2478RC		
VSV3072RDF	VSV4272CLDF	VSV2048ERY*	VSV2448ELY*	VSV2060LLR*	VST2078RC*	VST2478RC		
VST3672LBD	VST4272CRD	VST2054ELR*	VST2448ERCR*	VST2054LRR*	VST2084LC*	VST2484LC		
VSV3672LBD	VSV4272CRD	VSV2054ELR*	VSV2448ERCR*	VSV2054LRR*	VST2084LC*	VST2484LC		
VST3672LBDF	VST4272CRDF	VST2054ELY*	VST2448ERCY*	VST2054LLR*	VST2084RC*	VST2484RC		
VSV3672LBDF	VSV4272CRDF	VSV2054ELY*	VSV2448ERCY*	VSV2054LLR*	VST2084RC*	VST2484RC		
VST3672LD	VST4272LBD	VST2054ERR*	VST2448ERR*	VST2048LRR*	VST2084LRC	VST2484LRC		
VSV3672LD	VSV4272LBD	VSV2054ERR*	VSV2448ERR*	VST2048LRR*	VST2084LRC	VST2484LRC		
VST3672LDF	VST4272LBDF	VST2054ERY*	VST2448ERY*	VST2048LLR*	VST2084LRC	VST2484LRC		
VSV3672LDF	VSV4272LBDF	VSV2054ERY*	VSV2448ERY*	VST2048LLR*	VST2084LRC	VST2484LRC		
VST3672RBD	VST4272RBD	VST2060ELY*	VST2454ELR	VST2048LLR*	VST2078LRC	VST2478LRC		
VSV3672RBD	VSV4272RBD	VSV2060ELY*	VSV2454ELR	VST2048LLR*	VST2078LRC	VST2478LRC		
VST3672RBD	VST4272RBD	VST2060ERR*	VST2454ELY		VST2078LLC	VST2478LLC		
VSV3672RBD	VSV4272RBD	VSV2060ERR*	VSV2454ELY		VST2078LLC	VST2478LLC		
VST3672RDF	VST4872CBDF	VST2060ELR*	VST2454ERR		VST2072LRC	VST2472LRC		
VSV3672RDF	VSV4872CBDF	VSV2060ELR*	VSV2454ERR		VST2072LRC	VST2472LRC		
VST3672RDF	VST4872CBDF	VST2060ERY*	VST2454ERY		VST2072LRC	VST2472LRC		
VSV3672RDF	VSV4872CBDF	VSV2060ERY*	VSV2454ERY		VST2072LRC	VST2472LRC		
VST3684LBD	VST4872CBDR	VST2442ELCR*	VST2460ELR		VST2072LLC	VST2472LLC		
VSV3684LBD	VSV4872CBDR	VSV2442ELCR*	VSV2460ELR					
VST3684LBD	VST4872CBDR	VST2442ELCY*	VST2460ELY					
VSV3684LBD	VSV4872CBDR	VSV2442ELCY*	VSV2460ELY					
VST3684LBD	VST4872CBDR	VST2442ELR*	VST2460ERR					
VSV3684LBD	VSV4872CBDR	VSV2442ELR*	VSV2460ERR					
VST3684LBD	VST4872CBDR	VST2442ELY*	VST2460ERY					
VSV3684LBD	VSV4872CBDR	VSV2442ELY*	VSV2460ERY					



Vision Product Information

Peninsula and Modular Top Shapes

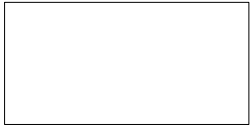

Rectangular/Soft Rectangular peninsula/modular

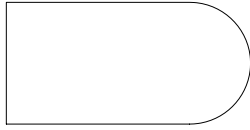

Bullet peninsula/modular

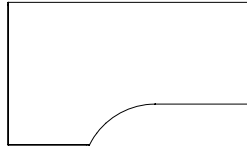

Extended Corner modular

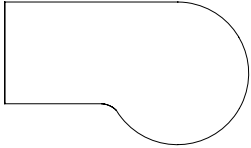

"P" Top peninsula

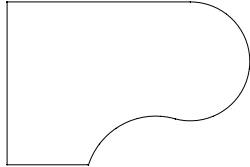

Extended Corner Bullet peninsula/modular

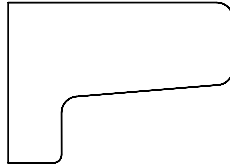

Sweeping L peninsula/modular

Base for Worksurface Tops and Finish/Metal Colors Options

These base styles can be used with Peninsula Desks and Modular Desk Tops.

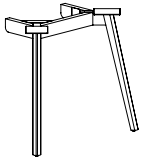

Taper Base solid wood finishes



Truss Base solid wood finishes



Column Base metal finishes

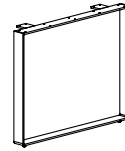

Perimeter Base chrome finish only

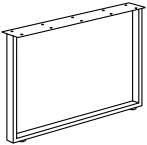

Rectangular Base metal finishes



Dowel Base Metal (upper section) metal finishes



Executive Base Vision laminate finishes Metal metal finishes

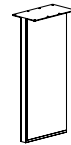

Executive Base Vision wood finishes, Metal metal finishes

Modular Top End Supports for Peninsula and Modular Tops

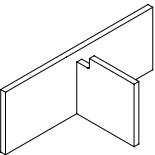

Bench Height "T" Support use with bench height configurations

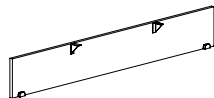

Bench Height Support with Metal Braces use with modular tops or bench height configurations

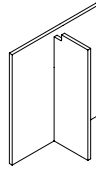

Full Height "T" Support use with peninsula or modular tops

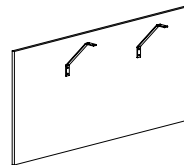

Full Height End Support with Metal Braces use with peninsula or modular tops

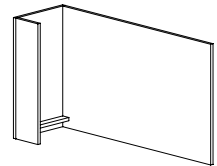

Wing End Support use to create a modular open corner credenza or desk



Vision Product Information

Electric Adjustable Height Table Desk - Standard/Extended/Pneumatic

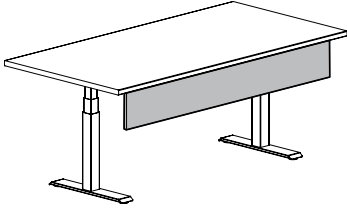

Height Adjustable Modesty Panel Recommendations

Top Depth	Top Width	Model Number
36/30/24	72	VST0964TDM / VSV0964TDM
30/24	84	VST0976TDM / VSV0976TDM
30/24	78	VST0970TDM / VSV0970TDM
30/24	66	VST0958TDM / VSV0958TDM
30/24	60	VST0952TDM / VSV0952TDM
30/24	54	VST0946TDM / VSV0946TDM
30/24	48	VST0940TDM / VSV0940TDM

Electric Adjustable Height Bridge - Standard/Extended/Pneumatic

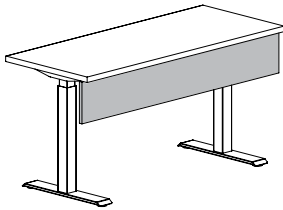

Top Depth	Top Width	Model Number
24	58	VST0958TDM / VSV0958TDM
24	52	VST0952TDM / VSV0952TDM
24	46	VST0940TDM / VSV0940TDM
24	40	VST0940TDM / VSV0940TDM

Adjustable Height Corner Table - One Piece Top - Standard/Extended

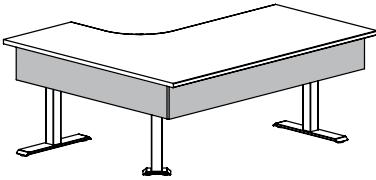

Top Depth	Top Width	Model Number
36/30	72	VST7203TDM / VSV7203TDM
36/30	66	VST6603TDM / VSV6603TDM
36/30	60	VST6003TDM / VSV6003TDM
24	72	VST7204TDM / VSV7204TDM
24	66	VST6604TDM / VSV6604TDM
24	60	VST6004TDM / VSV6004TDM

Adjustable Height Corner Table - Two Piece Top - Standard/Extended

Adjustable Height Table & Return - Two Piece Top - Standard/Extended

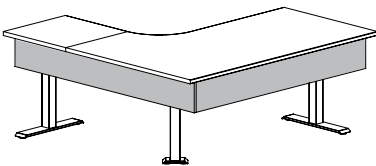

Top Depth	Top Width	Model Number
36/30	72	VST7201TDM / VSV7201TDM
36/30	66	VST6601TDM / VSV6601TDM
36/30	60	VST6001TDM / VSV6001TDM
24	72	VST7202TDM / VSV7202TDM
24	66	VST6602TDM / VSV6602TDM
24	60	VST6002TDM / VSV6002TDM



Vision Product Information

Rectangular Table & Run-Off Top (for use with Adj. Height T-Base)

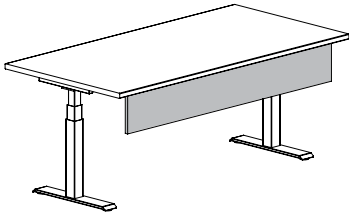

Height Adjustable Modesty Panel Recommendations

Top Depth	Top Width	Model Number
36	72	VST0964TDM / VSV0964TDM
30	84	VST0976TDM / VSV0976TDM
30	78	VST0970TDM / VSV0970TDM
30	72	VST0964TDM / VSV0964TDM
30	66	VST0958TDM / VSV0958TDM
30	60	VST0952TDM / VSV0952TDM
30	54	VST0946TDM / VSV0946TDM
30	48	VST0940TDM / VSV0940TDM
24	84	VST0976TDM / VSV0976TDM
24	78	VST0970TDM / VSV0970TDM
24	72	VST0964TDM / VSV0964TDM
24	66	VST0958TDM / VSV0958TDM
24	60	VST0952TDM / VSV0952TDM
24	54	VST0946TDM / VSV0946TDM
24	48	VST0940TDM / VSV0940TDM

Bridge Top (for use with Adj. Height T-Base)

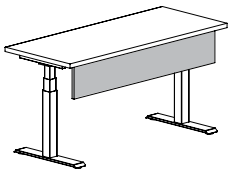

Top Depth	Top Width	Model Number
24	58	VST0952TDM / VSV0952TDM
24	52	VST0946TDM / VSV0946TDM
24	46	VST0940TDM / VSV0940TDM

Corner Desk Top (for use with Adj. Height T-Base)

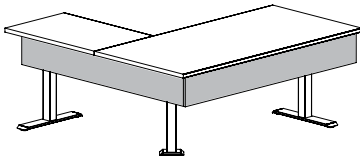

Top Depth	Top Width	Model Number
36/30	72	VST7201TDM / VSV7201TDM
36/30	66	VST6601TDM / VSV6601TDM
36/30	60	VST6001TDM / VSV6001TDM
24	72	VST7202TDM / VSV7202TDM
24	66	VST6602TDM / VSV6602TDM
24	60	VST6002TDM / VSV6002TDM

Cockpit Corner Desk Top (for use with Adj. Height T-Base)

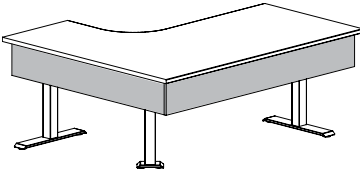

Top Depth	Top Width	Model Number
36/30	72	VST7203TDM / VSV7203TDM
36/30	66	VST6603TDM / VSV6603TDM
36/30	60	VST6003TDM / VSV6003TDM
24	72	VST7204TDM / VSV7204TDM
24	66	VST6604TDM / VSV6604TDM
24	60	VST6004TDM / VSV6004TDM

Cockpit Corner Desk Top - Two Piece (for use with Adj. Height T-Base)

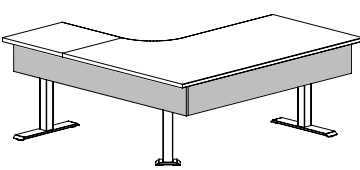

Top Depth	Top Width	Model Number
36/30	72	VST7201TDM / VSV7201TDM
36/30	66	VST6601TDM / VSV6601TDM
36/30	60	VST6001TDM / VSV6001TDM
24	72	VST7202TDM / VSV7202TDM
24	66	VST6602TDM / VSV6602TDM
24	60	VST6002TDM / VSV6002TDM

Vision Product Information

Table Desk

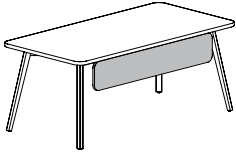

Modesty Panel Recommendations

Top Depth	Top Width	Model Number
36/30	72	VST5410HMMPR / VSV5410HMMPR
36/30	66	VST4810HMMPR / VST4810HMMPR

Bullet Peninsula Desk

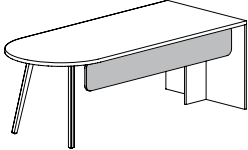

Top Depth	Top Width	Model Number
36/30	84	VST6610HMPS / VST6610HMMPR
		VSV6610HMPS / VSV6610HMMPR
36/30	78	VST6010HMPS / VST6010HMMPR
		VSV6010HMPS / VSV6010HMMPR
36/30	72	VST5410HMPS / VST5410HMMPR
		VSV5410HMPS / VSV5410HMMPR
30	66	VST4810HMPS / VST4810HMMPR
		VSV4810HMPS / VSV4810HMMPR

Cockpit Bullet Peninsula Desk

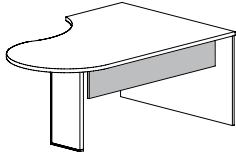

Top Depth	Top Width	Model Number
48	72	VST5410HMPS / VST5410HMMPR
		VSV5410HMPS / VSV5410HMMPR

Rectangular Peninsula Desk/Soft Rectangular Desk

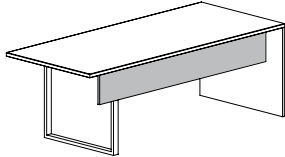

Top Depth	Top Width	Model Number
36/30	84	VST7210HMPS / VST7210HMMPR
		VSV7210HMPS / VSV7210HMMPR
36/30	78	VST6610HMPS / VST6610HMMPR
		VSV6610HMPS / VSV6610HMMPR
36/30	72	VST6010HMPS / VST6010HMMPR
		VSV6010HMPS / VSV6010HMMPR
36/30	66	VST5410HMPS / VST5410HMMPR
		VSV5410HMPS / VSV5410HMMPR
36/30	60	VST4810HMPS / VST4810HMMPR
		VSV4810HMPS / VSV4810HMMPR

P-Top Peninsula Desk

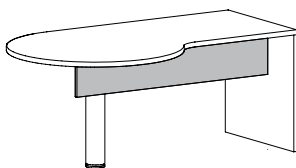

Top Depth	Top Width	Model Number
42	84	VST6610HMPS / VST6610HMMPR
		VSV6610HMPS / VSV6610HMMPR
42	78	VST6010HMPS / VST6010HMMPR
		VSV6010HMPS / VSV6010HMMPR
42	72	VST5410HMPS / VST5410HMMPR
		VSV5410HMPS / VSV5410HMMPR



Vision Product Information

Sweeping L Peninsula Desk

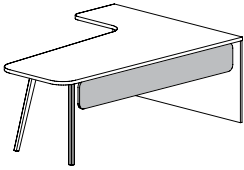

Modesty Panel Recommendations

Top Depth	Top Width	Model Number
60	84	VST7210HMPS / VST7210HMPCR
		VSV7210HMPS / VSV7210HMPCR
60	78	VST6610HMPS / VST6610HMPCR
		VSV6610HMPS / VSV6610HMPCR
60	72	VST6010HMPS / VST6010HMPCR
		VSV6010HMPS / VSV6010HMPCR
60	66	VST5410HMPS / VST5410HMPCR
		VSV5410HMPS / VSV5410HMPCR
60	66	VST4810HMPS / VST4810HMPCR
		VSV4810HMPS / VSV4810HMPCR

Rectangular Workwall Peninsula Desk/Soft Rectangular Workwall Peninsula Desk

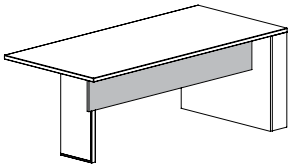

Top Depth	Top Width	Model Number
36/30	84	VST6610HMPS / VST6610HMPCR
		VSV6610HMPS / VSV6610HMPCR
36/30	78	VST6010HMPS / VST6010HMPCR
		VSV6010HMPS / VSV6010HMPCR
36/30	72	VST5410HMPS / VST5410HMPCR
		VSV5410HMPS / VSV5410HMPCR
36/30	66	VST4810HMPS / VST4810HMPCR
		VSV4810HMPS / VSV4810HMPCR
36/30	60	VST4210HMPS / VST4210HMPCR
		VSV4210HMPS / VSV4210HMPCR

Rectangular Run-Off Desk Top/Soft Rectangular Run-Off Desk Top

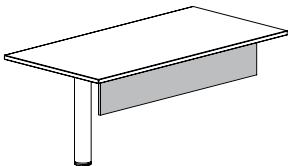

Top Depth	Top Width	Model Number
36/30	72	VST6010HMPS / VST6010HMPCR
		VSV6010HMPS / VSV6010HMPCR
36/30	66	VST5410HMPS / VST5410HMPCR
		VSV5410HMPS / VSV5410HMPCR
36/30	60	VST4810HMPS / VST4810HMPCR
		VSV4810HMPS / VSV4810HMPCR
36/30	54	VST4210HMPS / VST4210HMPCR
		VSV4210HMPS / VSV4210HMPCR
36/30	48	VST3610HMPS / VST3610HMPCR
		VSV3610HMPS / VSV3610HMPCR

Bullet Run-Off Desk

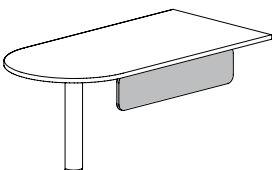

Top Depth	Top Width	Model Number
36	72	VST4210HMPS / VST4210HMPCR
		VSV4210HMPS / VSV4210HMPCR
36	66	VST3610HMPS / VST3610HMPCR
		VSV3610HMPS / VSV3610HMPCR
36	60	VST3010HMPS / VST3010HMPCR
		VSV3010HMPS / VSV3010HMPCR

Vision Product Information

Bench Height Supported Bullet Peninsula Desk

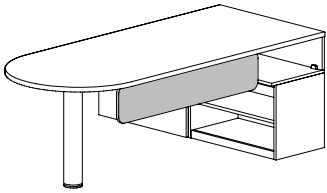

Modesty Panel Recommendations

Top Depth	Top Width	Model Number
36/30	84	VST4210HMPS / VST4210HMPR
		VSV4210HMPS / VSV4210HMPR
36/30	78	VST3610HMPS / VST3610HMPR
		VSV3610HMPS / VSV3610HMPR
36/30	72	VST3010HMPS / VST3010HMPR
		VSV3010HMPS / VSV3010HMPR

Bench Height Supported Rectangular Peninsula Desk /Bench Height Supported Soft Rectangular

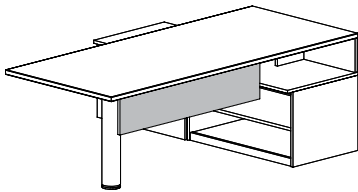

Top Depth	Top Width	Model Number
36/30	84	VST4810HMPS / VST4810HMPR
		VSV4810HMPS / VSV4810HMPR
36/30	78	VST4210HMPS / VST4210HMPR
		VSV4210HMPS / VSV4210HMPR
36/30	72	VST3610HMPS / VST3610HMPR
		VSV3610HMPS / VSV3610HMPR
36/30	66	VST3010HMPS / VST3010HMPR
		VSV3010HMPS / VSV3010HMPR
36/30	60	VST2410HMPS / VST2410HMPR
		VSV2410HMPS / VSV2410HMPR

Bench Height Supported P-Top Peninsula Desk

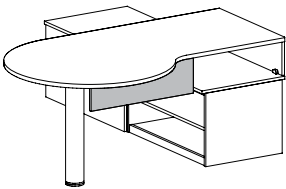

Top Depth	Top Width	Model Number
42	84	VST4210HMPS / VST4210HMPR
		VSV4210HMPS / VSV4210HMPR
42	78	VST3610HMPS / VST3610HMPR
		VSV3610HMPS / VSV3610HMPR
42	72	VST3010HMPS / VST3010HMPR
		VSV3010HMPS / VSV3010HMPR

Bench Height Sweeping L Desk

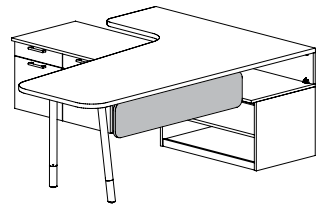

Top Depth	Top Width	Model Number
60	84	VST4810HMPS / VST4810HMPR
		VSV4810HMPS / VSV4810HMPR
60	78	VST4210HMPS / VST4210HMPR
		VSV4210HMPS / VSV4210HMPR
60	72	VST3610HMPS / VST3610HMPR
		VSV3610HMPS / VSV3610HMPR
60	66	VST3010HMPS / VST3010HMPR
		VSV3010HMPS / VSV3010HMPR



Vision Product Information

Bullet Return Top

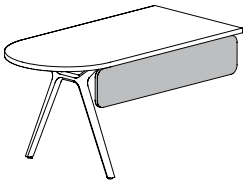

Modesty Panel Recommendations

Top Depth	Top Width	Model Number
30/24	60	VST4810HMPS / VST4810HMPCR
		VSV4810HMPS / VSV4810HMPCR
30/24	48	VST3610HMPS / VST3610HMPCR
		VSV3610HMPS / VSV3610HMPCR

Modular Bullet Desk Top

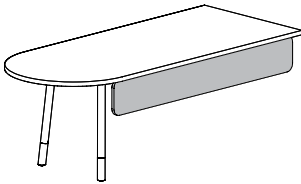

Top Depth	Top Width	Model Number
36	84	VST6610HMPS / VST6610HMPCR
		VSV6610HMPS / VSV6610HMPCR
36	78	VST6010HMPS / VST6010HMPCR
		VSV6010HMPS / VSV6010HMPCR
36/30	72	VST5410HMPS / VST5410HMPCR
		VSV5410HMPS / VSV5410HMPCR
36/30	66	VST4810HMPS / VST4810HMPCR
		VSV4810HMPS / VSV4810HMPCR
24	60	VST4210HMPS / VST4210HMPCR
		VSV4210HMPS / VSV4210HMPCR
24	48	VST3010HMPS / VST3010HMPCR
		VSV3010HMPS / VSV3010HMPCR

Modular Sweeping L Desk Top

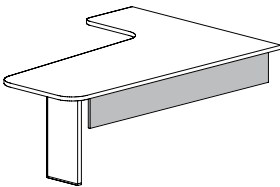

Top Depth	Top Width	Model Number
60	84	VST7210HMPS / VST7210HMPCR
		VSV7210HMPS / VSV7210HMPCR
60	78	VST6610HMPS / VST6610HMPCR
		VSV6610HMPS / VSV6610HMPCR
60	72	VST6010HMPS / VST6010HMPCR
		VSV6010HMPS / VSV6010HMPCR
60	66	VST5410HMPS / VST5410HMPCR
		VSV5410HMPS / VSV5410HMPCR
60	60	VST4810HMPS / VST4810HMPCR
		VSV4810HMPS / VSV4810HMPCR

Modular Extended Corner Bullet Desk Top

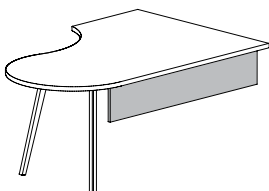

Top Depth	Top Width	Model Number
48/42	72	VST5410HMPS / VST5410HMPCR
		VSV5410HMPS / VSV5410HMPCR
42	66	VST4810HMPS / VST4810HMPCR
		VSV4810HMPS / VSV4810HMPCR



Vision Product Information

Returns with Breakfront

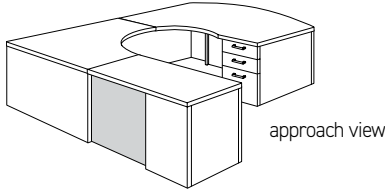

Consists of:
 VST2442MCT - top
 VST1624MFF - pedestal
 VST2728MDRA - breakfront modesty panel
 VST1628MPBK - back panel

Modesty Panel Sizes for Returns with Pedestal

Top Width	Pedestal Width	Modesty Width	Modesty Height	Model Number
36	15 7/8	21 3/16	28	VST2128MDRA
42	15 7/8	27 3/16	28	VST2728MDRA
48	15 7/8	33 3/16	28	VST3328MDRA
54	15 7/8	39 3/16	28	VST3928MDRA
60	15 7/8	45 3/16	28	VST4528MDRA

Returns with Breakfront

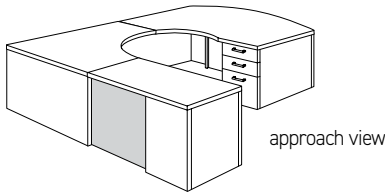

Consists of:
 VST2448MCT - top
 VST3624MLF - pedestal
 VST1328MDRB - modesty panel
 VST3628MPBK - back panel

Modesty Panel Sizes for Returns with Lateral File Pedestal

Top Width	Pedestal 36" Wide	Modesty Width	Modesty Height	Model Number
42	35 7/8	6 15/16	28	VST0728MDRB
48	35 7/8	12 15/16	28	VST1328MDRB
54	35 7/8	18 15/16	28	VST1828MDRB
60	35 7/8	24 15/16	28	VST2528MDRB

Top Width	Pedestal 30" Wide	Modesty Width	Modesty Height	Model Number
36	29 7/8	6 15/16	28	VST0728MDRB
42	29 7/8	12 15/16	28	VST1328MDRB
48	29 7/8	18 15/16	28	VST1828MDRB
54	29 7/8	24 15/16	28	VST2528MDRB
60	29 7/8	30 15/16	28	VST3128MDRB



Vision Product Information

Return Shells with Breakfront

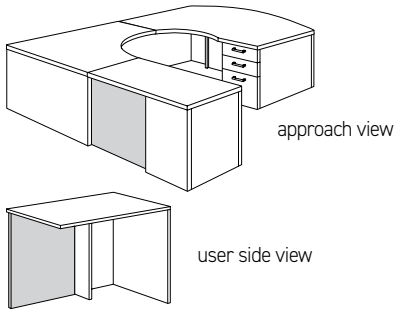

Consists of:
 VST2442MCT - top
 VST1624WEAR - wing end panel
 VST2728MDRA - breakfront modesty panel

Modesty Panel Sizes for Return Shells using VST1624WEAL or VST1624WEAR wing end panel

Top Width	Wing Assembly Width	Modesty Width	Modesty Height	Model Number
36	15 5/8	21 3/16	28	VST2128MDRA
42	15 5/8	27 3/16	28	VST2728MDRA
48	15 5/8	33 3/16	28	VST3328MDRA
54	15 5/8	39 3/16	28	VST3928MDRA
60	15 5/8	45 3/16	28	VST4528MDRA

Return Shells

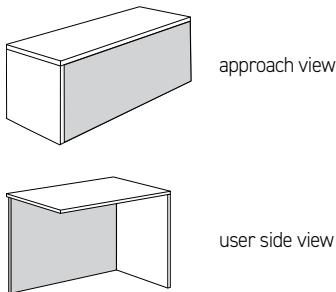

Consists of:
 VST2442MCT - top
 VST24EP - end panel
 VST4328MDRS - modesty panel

Modesty Panel Sizes for Return Shells using VST24EP end panel

Top Width	End Panel Thickness VST24EP	Modesty Width	Modesty Height	Model Number
36	3/4	36 1/16	28	VST3728MDRS
42	3/4	42 1/16	28	VST4328MDRS
48	3/4	48 1/16	28	VST4928MDRS
54	3/4	54 1/16	28	VST5528MDRS

Desk Shells

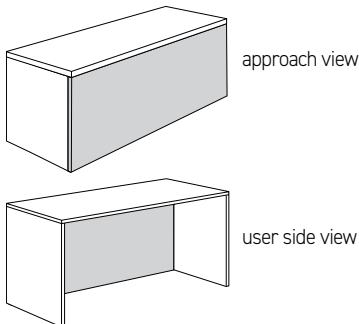

Consists of:
 VST2442MCT - top
 VST23EP - (2) end panels
 VST4228MBK - modesty panel

Modesty Panel Sizes for Desk Shells with both left and right ends using VST23EP end panel

Top Width	End Panel Thickness VST23EP	Modesty Width	Modesty Height	Model Number
30	3/4	29 5/8	28	VST3028MBK
36	3/4	35 5/8	28	VST3628MBK
42	3/4	41 5/8	28	VST4228MBK
48	3/4	47 5/8	28	VST4828MBK
54	3/4	53 5/8	28	VST5428MBK
60	3/4	59 5/8	28	VST6028MBK



Vision Product Information

Desk Shells with Breakfront

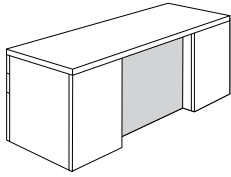

approach view of unit using wing end panels

Consists of:

- VST1630WEAL - left wing end panel
- VST1630WEAR - right wing end panel
- VST4128MDDE - breakfront modesty panel
- VST3072MCT - top

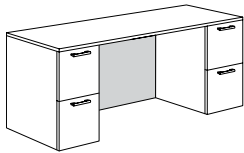

user side view of double ped desk

Consists of:

- VST1630MFF - (2) 30" deep modular pedestals
- VST4128MDDE - breakfront modesty panel
- VST3072MCT - top
- VST1628MPBK - (2) back panel

Modular Breakfront Modesty Panel Sizes for double pedestal desks and credenzas -OR- Single pedestal desks and credenzas with the VST1630WEAL or VST1630WEAR wing end assembly or with the VST1624WEAL or VST1624WEAR wing end assembly

Top Width	Right or Left Pedestal or Wing End Assembly Width	Modesty Width	Modesty Height	Model Number
60	15 3/8"	28 3/8"	28"	VST2928MDDE
66	15 3/8"	34 3/8"	28"	VST3528MDDE
72	15 3/8"	40 3/8"	28"	VST4128MDDE
78	15 3/8"	46 3/8"	28"	VST4728MDDE
84	15 3/8"	52 3/8"	28"	VST5328MDDE
90	15 3/8"	58 3/8"	28"	VST5928MDDE

Credenza with Breakfront

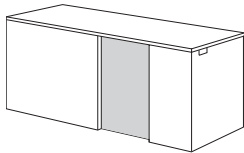

approach view

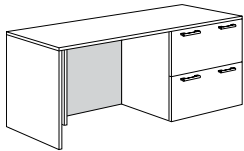

user side view

Consists of:

- VST3624MLF - pedestal
- VST1624WEAL - wing end support
- VST2128MDCG - breakfront modesty panel
- VST2472MCT - top
- VST3628MPBK - back panel

Modular Breakfront Modesty Panel Sizes for Single Pedestal Credenzas with 30" or 36" wide pedestal -OR- using the VST1624WEAL OR VST1624WEAR wing end assembly.

Top Width	36" Pedestal Width	Wing End Assembly Width	Modesty Width	Modesty Height	Model Number
66	35 3/8"	15 3/8"	14 3/8"	28"	VST1528MDCG
72	35 3/8"	15 3/8"	20 3/8"	28"	VST2128MDCG
78	35 3/8"	15 3/8"	26 3/8"	28"	VST2628MDCG
84	35 3/8"	15 3/8"	32 3/8"	28"	VST3328MDCG
90	35 3/8"	15 3/8"	38 3/8"	28"	VST3928MDCG
96	35 3/8"	15 3/8"	44 3/8"	28"	VST4528MDCG

Top Width	30" Pedestal Width	Wing End Assembly Width	Modesty Width	Modesty Height	Model Number
60	29 3/8"	15 3/8"	14 3/8"	28"	VST1528MDCG
66	29 3/8"	15 3/8"	20 3/8"	28"	VST2128MDCG
72	29 3/8"	15 3/8"	26 3/8"	28"	VST2728MDCG
78	29 3/8"	15 3/8"	32 3/8"	28"	VST3328MDCG
84	29 3/8"	15 3/8"	38 3/8"	28"	VST3928MDCG
90	29 3/8"	15 3/8"	44 3/8"	28"	VST4528MDCG
96	29 3/8"	15 3/8"	50 3/8"	28"	VST5128MDCG



Vision Product Information

Desks Model	Description	Drawer Configuration (User Side)	
		Left Pedestal	Right Pedestal
VST4272BD	Double Pedestal Bow Desk	Box/Box/File	File/File
VST4272BDF	Double Pedestal Bow Desk	Box/Box/File	File/File
VST3684BD	Double Pedestal Bow Desk	Box/Box/File	File/File
VST3684BDF	Double Pedestal Bow Desk	Box/Box/File	File/File
VST3672BD	Double Pedestal Bow Desk	Box/Box/File	File/File
VST3672BDF	Double Pedestal Bow Desk	Box/Box/File	File/File
VST3684DD	Double Pedestal Desk	Box/Box/File	File/File
VST3684DDF	Double Pedestal Desk	Box/Box/File	File/File
VST3678DD	Double Pedestal Desk	Box/Box/File	File/File
VST3678DDF	Double Pedestal Desk	Box/Box/File	File/File
VST3672DD	Double Pedestal Desk	Box/Box/File	File/File
VST3672DDF	Double Pedestal Desk	Box/Box/File	File/File
VST3072DD	Double Pedestal Desk	Box/Box/File	File/File
VST3072DDF	Double Pedestal Desk	Box/Box/File	File/File
VST3066DD	Double Pedestal Desk	Box/Box/File	File/File
VST3066DDF	Double Pedestal Desk	Box/Box/File	File/File
VST3060DD	Double Pedestal Desk	Box/Box/File	File/File
VST3060DDF	Double Pedestal Desk	Box/Box/File	File/File
VST4872CBDR	Right Ped. Bow Cockpit Desk		Box/Box/File
VST4872CBDRF	Right Ped. Bow Cockpit Desk		Box/Box/File
VST4872CBDL	Left Ped. Bow Cockpit Desk	Box/Box/File	
VST4872CBDLF	Left Ped. Bow Cockpit Desk	Box/Box/File	
VST4272CRD	Right Ped. Cockpit Desk		Box/Box/File
VST4272CRDF	Right Ped. Cockpit Desk		Box/Box/File
VST4272CLD	Left Pedestal Cockpit Desk	Box/Box/File	
VST4272CLDF	Left Pedestal Cockpit Desk	Box/Box/File	
VST4272RBD	Right Pedestal Bow Desk		Box/Box/File
VST4272RBDF	Right Pedestal Bow Desk		Box/Box/File
VST4272LBD	Left Pedestal Bow Desk	Box/Box/File	
VST4272LBDF	Left Pedestal Bow Desk	Box/Box/File	
VST3684RBD	Right Pedestal Bow Desk		Box/Box/File
VST3684RBDF	Right Pedestal Bow Desk		Box/Box/File
VST3684LBD	Left Pedestal Bow Desk	Box/Box/File	
VST3684LBDF	Left Pedestal Bow Desk	Box/Box/File	
VST3672RBD	Right Pedestal Bow Desk		Box/Box/File
VST3672RBDF	Right Pedestal Bow Desk		Box/Box/File
VST3672LBD	Left Pedestal Bow Desk	Box/Box/File	
VST3672LBDF	Left Pedestal Bow Desk	Box/Box/File	
VST3684RD	Right Pedestal Desk		Box/Box/File
VST3684RDF	Right Pedestal Desk		Box/Box/File
VST3684LD	Left Pedestal Desk	Box/Box/File	
VST3684LDF	Left Pedestal Desk	Box/Box/File	
VST3672RD	Right Pedestal Desk		Box/Box/File
VST3672RDF	Right Pedestal Desk		Box/Box/File
VST3672LD	Left Pedestal Desk	Box/Box/File	
VST3672LDF	Left Pedestal Desk	Box/Box/File	

Desks Model	Description	Drawer Configuration (User Side)	
		Left Pedestal	Right Pedestal
VST3072RD	Right Pedestal Desk		Box/Box/File
VST3072RDF	Right Pedestal Desk		Box/Box/File
VST3072LD	Left Pedestal Desk	Box/Box/File	
VST3072LDF	Left Pedestal Desk	Box/Box/File	
VST3066RD	Right Pedestal Desk		Box/Box/File
VST3066RDF	Right Pedestal Desk		Box/Box/File
VST3066LD	Left Pedestal Desk	Box/Box/File	
VST3066LDF	Left Pedestal Desk	Box/Box/File	

Interior Drawer Dimensions	Depth	Width	Height
Box	21"	12"	3 1/4"
File	21"	12"	9 1/8"

Filing Options (Diagram 1)

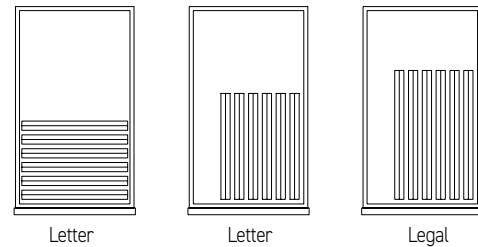

Vision Product Information

Executive Returns		Drawer Configuration (User Side)	
Model	Description	Left Pedestal	Right Pedestal
VST2460ERR	Right Executive Return		File/File
VST2460ELR	Left Executive Return	File/File	
VST2454ERR	Right Executive Return		File/File
VST2454ELR	Left Executive Return	File/File	
VST2448ERR	Right Executive Return		File/File
VST2448ELR	Left Executive Return	File/File	
VST2442ERR	Right Executive Return		File/File
VST2442ELR	Left Executive Return	File/File	
VST2060ERR	Right Executive Return		File/File
VST2060ELR	Left Executive Return	File/File	
VST2054ERR	Right Executive Return		File/File
VST2054ELR	Left Executive Return	File/File	
VST2048ERR	Right Executive Return		File/File
VST2048ELR	Left Executive Return	File/File	
VST2042ERR	Right Executive Return		File/File
VST2042ELR	Left Executive Return	File/File	
VST2460ERY	Right Executive Return		Box/Box/File
VST2460ELY	Left Executive Return	Box/Box/File	
VST2454ERY	Right Executive Return		Box/Box/File
VST2454ELY	Left Executive Return	Box/Box/File	
VST2448ERY	Right Executive Return		Box/Box/File
VST2448ELY	Left Executive Return	Box/Box/File	
VST2442ERY	Right Executive Return		Box/Box/File
VST2442ELY	Left Executive Return	Box/Box/File	
VST2060ERY	Right Executive Return		Box/Box/File
VST2060ELY	Left Executive Return	Box/Box/File	
VST2054ERY	Right Executive Return		Box/Box/File
VST2054ELY	Left Executive Return	Box/Box/File	
VST2048ERY	Right Executive Return		Box/Box/File
VST2048ELY	Left Executive Return	Box/Box/File	
VST2042ERY	Right Executive Return		Box/Box/File
VST2042ELY	Left Executive Return	Box/Box/File	
VST2460ERCR	Right Corner Return		File/File
VST2460ELCR	Left Corner Return	File/File	
VST2454ERCR	Right Corner Return		File/File
VST2454ELCR	Left Corner Return	File/File	
VST2448ERCR	Right Corner Return		File/File
VST2448ELCR	Left Corner Return	File/File	
VST2442ERCR	Right Corner Return		File/File
VST2442ELCR	Left Corner Return	File/File	
VST2460ERCY	Right Corner Return		Box/Box/File
VST2460ELCY	Left Corner Return	Box/Box/File	
VST2454ERCY	Right Corner Return		Box/Box/File
VST2454ELCY	Left Corner Return	Box/Box/File	
VST2448ERCY	Right Corner Return		Box/Box/File
VST2448ELCY	Left Corner Return	Box/Box/File	
VST2442ERCY	Right Corner Return		Box/Box/File
VST2442ELCY	Left Corner Return	Box/Box/File	
VST2060ERCR	Right Corner Return		File/File
VST2060ELCR	Left Corner Return	File/File	
VST2054ERCR	Right Corner Return		File/File
VST2054ELCR	Left Corner Return	File/File	
VST2048ERCR	Right Corner Return		File/File
VST2048ELCR	Left Corner Return	File/File	
VST2042ERCR	Right Corner Return		File/File
VST2042ELCR	Left Corner Return	File/File	
VST2060ERCY	Right Corner Return		Box/Box/File
VST2060ELCY	Left Corner Return	Box/Box/File	

Executive Returns (continued)		Drawer Configuration (User Side)	
Model	Description	Left Pedestal	Right Pedestal
VST2054ERCY	Right Corner Return		Box/Box/File
VST2054ELCY	Left Corner Return	Box/Box/File	
VST2048ERCY	Right Corner Return		Box/Box/File
VST2048ELCY	Left Corner Return	Box/Box/File	
VST2042ERCY	Right Corner Return		Box/Box/File
VST2042ELCY	Left Corner Return	Box/Box/File	
VST2460LRR	Right Lateral Return		Lat. File/Lat. File
VST2460LLR	Left Lateral Return	Lat. File/Lat. File	
VST2454LRR	Right Lateral Return		Lat. File/Lat. File
VST2454LLR	Left Lateral Return	Lat. File/Lat. File	
VST2448LRR	Right Lateral Return		Lat. File/Lat. File
VST2448LLR	Left Lateral Return	Lat. File/Lat. File	
VST2060LRR	Right Lateral Return		Lat. File/Lat. File
VST2060LLR	Left Lateral Return	Lat. File/Lat. File	
VST2054LRR	Right Lateral Return		Lat. File/Lat. File
VST2054LLR	Left Lateral Return	Lat. File/Lat. File	
VST2048LRR	Right Lateral Return		Lat. File/Lat. File
VST2048LLR	Left Lateral Return	Lat. File/Lat. File	
VST2460LRCR	Right Lateral Corner Return		Lat. File/Lat. File
VST2460LLCR	Left Lateral Corner Return	Lat. File/Lat. File	
VST2454LRCR	Right Lateral Corner Return		Lat. File/Lat. File
VST2454LLCR	Left Lateral Corner Return	Lat. File/Lat. File	
VST2448LRCR	Right Lateral Corner Return		Lat. File/Lat. File
VST2448LLCR	Left Lateral Corner Return	Lat. File/Lat. File	
VST2060LRCR	Right Lateral Corner Return		Lat. File/Lat. File
VST2060LLCR	Left Lateral Corner Return	Lat. File/Lat. File	
VST2054LRCR	Right Lateral Corner Return		Lat. File/Lat. File
VST2054LLCR	Left Lateral Corner Return	Lat. File/Lat. File	
VST2048LRCR	Right Lateral Corner Return		Lat. File/Lat. File
VST2048LLCR	Left Lateral Corner Return	Lat. File/Lat. File	

Interior Drawer Dimensions	Depth	Width	Height
Box	15"	12"	3 1/4"
File	15"	12"	9 1/8"
Lateral File	15"	32 5/16"	9 1/8"

Filing Options (Diagram 4)

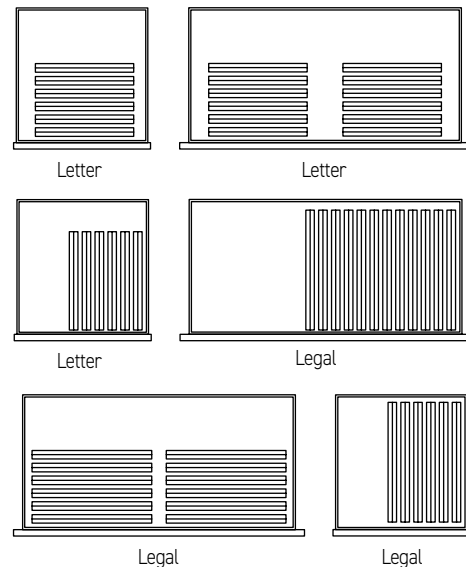

Vision Product Information

Executive Returns		Drawer Configuration (User Side)	
Model	Description	Left Pedestal	Right Pedestal
VST2460MLR	Right Multi-File Return		2 Box/File/Lateral File
VST2460MLL	Left Multi-File Return	2 Box/File/Lateral File	
VST2454MLR	Right Multi-File Return		2 Box/File/Lateral File
VST2454MLL	Left Multi-File Return	2 Box/File/Lateral File	
VST2448MLR	Right Multi-File Return		2 Box/File/Lateral File
VST2448MLL	Left Multi-File Return	2 Box/File/Lateral File	
VST2060MLR	Right Multi-File Return		2 Box/File/Lateral File
VST2060MLL	Left Multi-File Return	2 Box/File/Lateral File	
VST2054MLR	Right Multi-File Return		2 Box/File/Lateral File
VST2054MLL	Left Multi-File Return	2 Box/File/Lateral File	
VST2048MLR	Right Multi-File Return		2 Box/File/Lateral File
VST2048MLL	Left Multi-File Return	2 Box/File/Lateral File	
VST2460MRCR	Rt. Multi-File Corner Return		2 Box/File/Lateral File
VST2460MLCR	Lt. Multi-File Corner Return	2 Box/File/Lateral File	
VST2454MRCR	Rt. Multi-File Corner Return		2 Box/File/Lateral File
VST2454MLCR	Lt. Multi-File Corner Return	2 Box/File/Lateral File	
VST2448MRCR	Rt. Multi-File Corner Return		2 Box/File/Lateral File
VST2448MLCR	Lt. Multi-File Corner Return	2 Box/File/Lateral File	
VST2060MRCR	Rt. Multi-File Corner Return		2 Box/File/Lateral File
VST2060MLCR	Lt. Multi-File Corner Return	2 Box/File/Lateral File	
VST2054MRCR	Rt. Multi-File Corner Return		2 Box/File/Lateral File
VST2054MLCR	Lt. Multi-File Corner Return	2 Box/File/Lateral File	
VST2048MRCR	Rt. Multi-File Corner Return		2 Box/File/Lateral File
VST2048MLCR	Lt. Multi-File Corner Return	2 Box/File/Lateral File	

Interior Drawer Dimensions	Depth	Width	Height
Box	15"	12"	3 1/4"
File	15"	12"	9 1/8"
Lateral File	15"	26 5/16"	9 1/8"

Filing Options (Diagram 3)

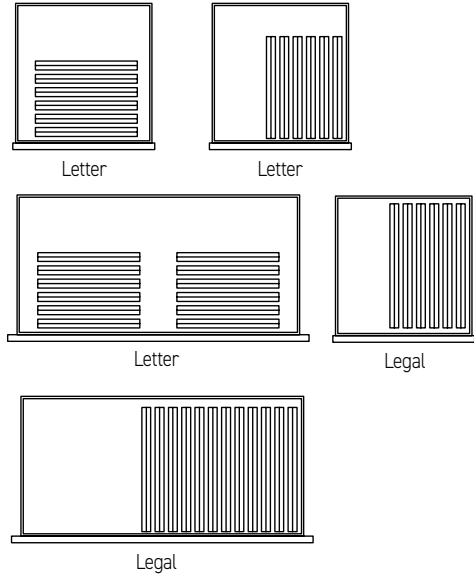

Mobile Pedestal		Drawer Configuration
Model	Description	Single Pedestal Width
VST1620MP	Mobile Pedestal	Box/Box/File

Interior Drawer Dimensions	Depth	Width	Height
Box	15"	12"	3 1/4"
File	15"	12"	9 1/8"

Filing Options (Diagram 2)

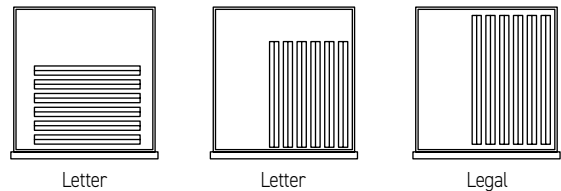

Credenzas		Drawer Configuration (User Side)	
Model	Description	Left Pedestal	Right Pedestal
VST2460LFC	Lateral File Credenza	Lat. File/Lat. File	Lat. File/Lat. File
VST2060LFC	Lateral File Credenza	Lat. File/Lat. File	Lat. File/Lat. File

Interior Drawer Dimensions	Depth	Width	Height
Lateral File	15"	26 5/16"	9 1/8"

Filing Options (Diagram 6)

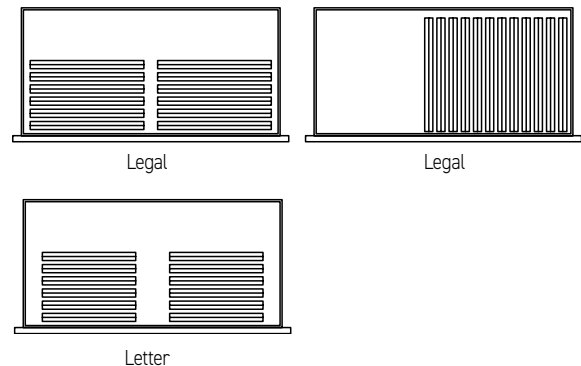

Vision Product Information

Credenzas	Model	Description	Drawer Configuration (User Side)	
			Left Pedestal	Right Pedestal
VST2472SC	Storage Credenza ¹		File/File	File/File
VST2466SC	Storage Credenza ¹		File/File	File/File
VST2072SC	Storage Credenza ¹		File/File	File/File
VST2066SC	Storage Credenza ¹		File/File	File/File
VST2484KC	Kneespace Credenza		File/File	File/File
VST2478KC	Kneespace Credenza		File/File	File/File
VST2472KC	Kneespace Credenza		File/File	File/File
VST2466KC	Kneespace Credenza		File/File	File/File
VST2460KC	Kneespace Credenza		File/File	File/File
VST2084KC	Kneespace Credenza		File/File	File/File
VST2078KC	Kneespace Credenza		File/File	File/File
VST2072KC	Kneespace Credenza		File/File	File/File
VST2066KC	Kneespace Credenza		File/File	File/File
VST2060KC	Kneespace Credenza		File/File	File/File

Interior Drawer Dimensions	Depth	Width	Height
File	15"	12"	9 1/8"

Filing Options (Diagram 2)

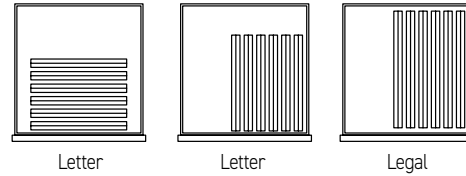

¹Center Section - Hinge Door Storage

Credenzas	Model	Description	Drawer Configuration (User Side)	
			Left Pedestal	Right Pedestal
VST2484RC	Right Pedestal Credenza			File/File
VST2484LC	Left Pedestal Credenza		File/File	
VST2478RC	Right Pedestal Credenza			File/File
VST2478LC	Left Pedestal Credenza		File/File	
VST2472RC	Right Pedestal Credenza			File/File
VST2472LC	Left Pedestal Credenza		File/File	
VST2466RC	Right Pedestal Credenza			File/File
VST2466LC	Left Pedestal Credenza		File/File	
VST2460RC	Right Pedestal Credenza			File/File
VST2460LC	Left Pedestal Credenza		File/File	
VST2084RC	Right Pedestal Credenza			File/File
VST2084LC	Left Pedestal Credenza		File/File	
VST2078RC	Right Pedestal Credenza			File/File
VST2078LC	Left Pedestal Credenza		File/File	
VST2072RC	Right Pedestal Credenza			File/File
VST2072LC	Left Pedestal Credenza		File/File	
VST2066RC	Right Pedestal Credenza			File/File
VST2066LC	Left Pedestal Credenza		File/File	
VST2060RC	Right Pedestal Credenza			File/File
VST2060LC	Left Pedestal Credenza		File/File	
VST2484LRC	Right Lat File Credenza			Lat. File/Lat. File
VST2484LLC	Left Lat File Credenza		Lat. File/Lat. File	
VST2478LRC	Right Lateral File Credenza			Lat. File/Lat. File
VST2478LLC	Left Lat File Credenza		Lat. File/Lat. File	
VST2472LRC	Right Lat File Credenza			Lat. File/Lat. File
VST2472LLC	Left Lat File Credenza		Lat. File/Lat. File	
VST2472LFC	Late File Credenza		Lat. File/Lat. File	Lat. File/Lat. File

Credenzas (continued)	Model	Description	Drawer Configuration (User Side)	
			Left Pedestal	Right Pedestal
VST2084LRC	Right Lateral File Credenza			Lat. File/Lat. File
VST2084LLC	Left Lateral File Credenza		Lat. File/Lat. File	
VST2078LRC	Right Lateral File Credenza			Lat. File/Lat. File
VST2078LLC	Left Lateral File Credenza		Lat. File/Lat. File	
VST2072LRC	Right Lateral File Credenza			Lat. File/Lat. File
VST2072LLC	Left Lateral File Credenza		Lat. File/Lat. File	
VST2072LFC	Lateral File Credenza		Lat. File/Lat. File	Lat. File/Lat. File

Interior Drawer Dimensions	Depth	Width	Height
File	15"	12"	9 1/8"
Lateral File	15"	32 5/16"	9 1/8"

Filing Options (Diagram 4)

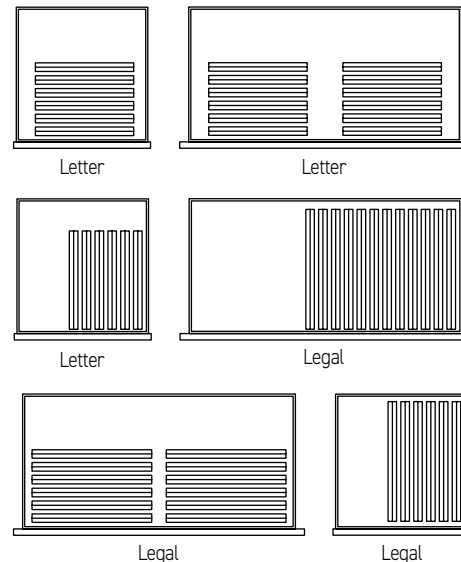

Vision Product Information

Credenzas		Drawer Configuration (User Side)	
Model	Description	Left Pedestal	Right Pedestal
VST2484MRC	Right Multi-File Credenza		2 Box/File/Lateral File
VST2484MLC	Left Multi-File Return	2 Box/File/Lateral File	
VST2478MRC	Right Multi-File Credenza		2 Box/File/Lateral File
VST2478MLC	Left Multi-File Return	2 Box/File/Lateral File	
VST2472MRC	Right Multi-File Credenza		2 Box/File/Lateral File
VST2472MLC	Left Multi-File Return	2 Box/File/Lateral File	
VST2084MRC	Right Multi-File Credenza		2 Box/File/Lateral File
VST2084MLC	Left Multi-File Return	2 Box/File/Lateral File	
VST2078MRC	Right Multi-File Credenza		2 Box/File/Lateral File
VST2078MLC	Left Multi-File Return	2 Box/File/Lateral File	
VST2072MRC	Right Multi-File Credenza		2 Box/File/Lateral File
VST2072MLC	Left Multi-File Return	2 Box/File/Lateral File	

Interior Drawer Dimensions	Depth	Width	Height
Box	15"	12"	3 1/4"
File	15"	12"	9 1/8"
Lateral File	15"	26 5/16"	9 1/8"

Filing Options (Diagram 3)

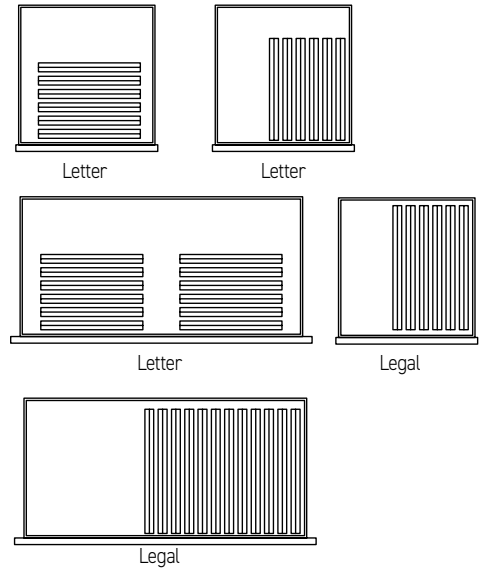

Buffet Credenzas		Drawer Configuration
Model	Description	Along the Top ²
VST2472BSC	Buffet Credenza ²	4 Box Drawers
VST2436BSC	Buffet Credenza ²	2 Box Drawers

Interior Drawer Dimensions	Depth	Width	Height
Box	15"	14 3/4"	3 1/4"

²Bottom Section - Hinge Door Storage

Lateral File Cabinets		Drawer Configuration
Model	Description	Single Lateral Pedestal Width
VST2036-57LF	4 Drawer Lateral File Cabinet	4 Lateral Drawers
VST2036-42LF	3 Drawer Lateral File Cabinet	3 Lateral Drawers
VST2036-30LF	2 Drawer Lateral File Cabinet	2 Lateral Drawers
VST2436-57LF	4 Drawer Lateral File Cabinet	4 Lateral Drawers
VST2436-42LF	3 Drawer Lateral File Cabinet	3 Lateral Drawers
VST2436-30LF	2 Drawer Lateral File Cabinet	2 Lateral Drawers

Interior Drawer Dimensions	Depth	Width	Height
Lateral File	15"	32 5/16"	9 1/8"

Filing Options (Diagram 5)

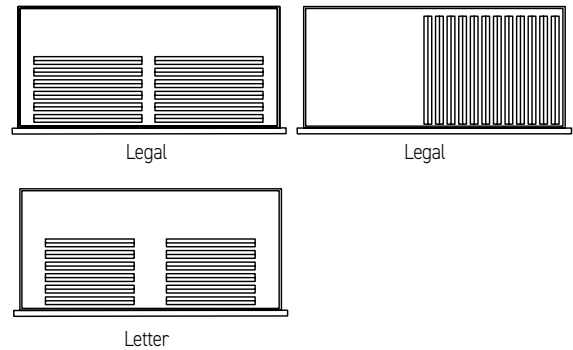

Lateral File Cabinets		Drawer Configuration
Model	Description	Single Lateral Pedestal Width
VST2030-57LF	4 Drawer Lateral File Cabinet	4 Lateral Drawers
VST2030-42LF	3 Drawer Lateral File Cabinet	3 Lateral Drawers
VST2030-30LF	2 Drawer Lateral File Cabinet	2 Lateral Drawers
VST2430-57LF	4 Drawer Lateral File Cabinet	4 Lateral Drawers
VST2430-42LF	3 Drawer Lateral File Cabinet	3 Lateral Drawers
VST2430-30LF	2 Drawer Lateral File Cabinet	2 Lateral Drawers

Interior Drawer Dimensions	Depth	Width	Height
Lateral File	15"	26 5/16"	9 1/8"

Filing Options (Diagram 6)

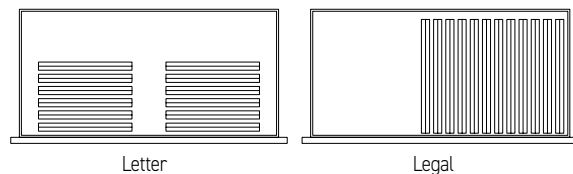

Vision Product Information

Tall Storage Cabinets		Drawer Configuration
Model	Description	Single Lateral Pedestal Width
VST2436-84BBFT	Storage Cabinet	Box/Box/Lateral File
VST2436-72BBFT	Storage Cabinet	Box/Box/Lateral File
VST2436-57BBFT	Storage Cabinet	Box/Box/Lateral File
VST2436-84FFT	Storage Cabinet	Lateral File/Lateral File
VST2436-72FFT	Storage Cabinet	Lateral File/Lateral File
VST2436-57FFT	Storage Cabinet	Lateral File/Lateral File
VST2036-84BBFT	Storage Cabinet	Box/Box/Lateral File
VST2036-72BBFT	Storage Cabinet	Box/Box/Lateral File
VST2036-57BBFT	Storage Cabinet	Box/Box/Lateral File
VST2036-84FFT	Storage Cabinet	Lateral File/Lateral File
VST2036-72FFT	Storage Cabinet	Lateral File/Lateral File
VST2036-57FFT	Storage Cabinet	Lateral File/Lateral File

Interior Drawer Dimensions	Depth	Width	Height
Box	15"	325/16"	31/4"
Lateral File	15"	325/16"	91/8"

Filing Options (Diagram 5)

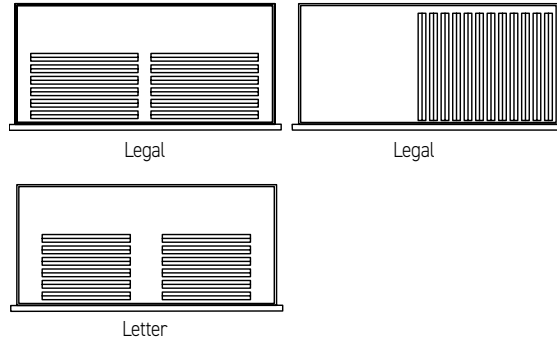

Tall Storage Cabinets		Drawer Configuration
Model	Description	Single Lateral Pedestal Width
VST2430-84BBFT	Storage Cabinet	Box/Box/Lateral File
VST2430-72BBFT	Storage Cabinet	Box/Box/Lateral File
VST2430-57BBFT	Storage Cabinet	Box/Box/Lateral File
VST2430-84FFT	Storage Cabinet	Lateral File/Lateral File
VST2430-72FFT	Storage Cabinet	Lateral File/Lateral File
VST2430-57FFT	Storage Cabinet	Lateral File/Lateral File
VST2030-84BBFT	Storage Cabinet	Box/Box/Lateral File
VST2030-72BBFT	Storage Cabinet	Box/Box/Lateral File
VST2030-57BBFT	Storage Cabinet	Box/Box/Lateral File
VST2030-84FFT	Storage Cabinet	Lateral File/Lateral File
VST2030-72FFT	Storage Cabinet	Lateral File/Lateral File
VST2030-57FFT	Storage Cabinet	Lateral File/Lateral File

Interior Drawer Dimensions	Depth	Width	Height
Box	15"	265/16"	31/4"
Lateral File	15"	265/16"	91/8"

Filing Options (Diagram 6)

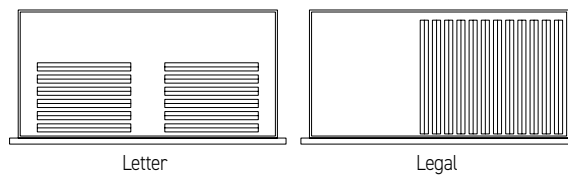

Tall Storage Cabinets		Drawer Configuration
Model	Description	Single Pedestal Width
VST2430-84MFR	Storage Cabinet	(Right) Box/Box-File/Lat. File
VST2430-84MFL	Storage Cabinet	(Left) Box/Box-File/Lat. File
VST2430-72MFR	Storage Cabinet	(Right) Box/Box-File/Lat. File
VST2430-72MFL	Storage Cabinet	(Left) Box/Box-File/Lat. File
VST2430-57MFR	Storage Cabinet	(Right) Box/Box-File/Lat. File
VST2430-57MFL	Storage Cabinet	(Left) Box/Box-File/Lat. File
VST2030-84MFR	Storage Cabinet	(Right) Box/Box-File/Lat. File
VST2030-84MFL	Storage Cabinet	(Left) Box/Box-File/Lat. File
VST2030-72MFR	Storage Cabinet	(Right) Box/Box-File/Lat. File
VST2030-72MFL	Storage Cabinet	(Left) Box/Box-File/Lat. File
VST2030-57MFR	Storage Cabinet	(Right) Box/Box-File/Lat. File
VST2030-57MFL	Storage Cabinet	(Left) Box/Box-File/Lat. File

Interior Drawer Dimensions	Depth	Width	Height
Box	15"	12"	31/4"
File	15"	12"	91/8"
Lateral File	15"	265/16"	91/8"

Filing Options (Diagram 3)

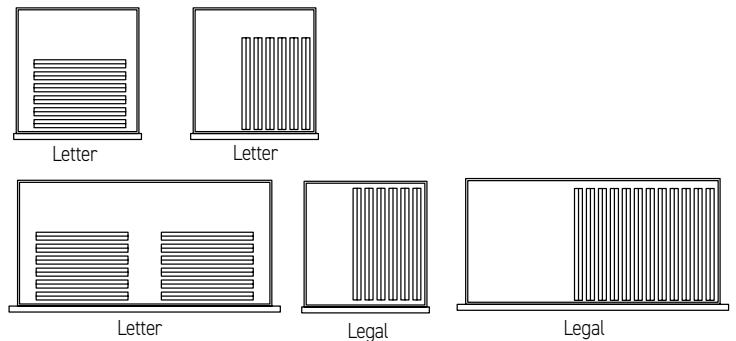

Vision Product Information

Tall Storage Cabinets		Drawer Configuration
Model	Description	Single Pedestal Width
VST2418-84BBFSSTR	Storage Cabinet	Box/Box/File
VST2418-84BBFSSTL	Storage Cabinet	Box/Box/File
VST2418-72BBFSSTR	Storage Cabinet	Box/Box/File
VST2418-72BBFSSTL	Storage Cabinet	Box/Box/File
VST2418-57BBFSSTR	Storage Cabinet	Box/Box/File
VST2418-57BBFSSTL	Storage Cabinet	Box/Box/File
VST2418-84FFSSTR	Storage Cabinet	File/File
VST2418-84FFSSTL	Storage Cabinet	File/File
VST2418-72FFSSTR	Storage Cabinet	File/File
VST2418-72FFSSTL	Storage Cabinet	File/File
VST2418-57FFSSTR	Storage Cabinet	File/File
VST2418-57FFSSTL	Storage Cabinet	File/File
VST2418-84BBFO	Storage Cabinet	Box/Box/File
VST2418-84FFO	Storage Cabinet	File/File
VST2418-84BBFTR	Storage Cabinet	Box/Box/File
VST2418-84BBFTL	Storage Cabinet	Box/Box/File
VST2418-72BBFO	Storage Cabinet	Box/Box/File
VST2418-72FFO	Storage Cabinet	File/File
VST2418-72BBFTR	Storage Cabinet	Box/Box/File
VST2418-72BBFTL	Storage Cabinet	Box/Box/File
VST2418-57BBFO	Storage Cabinet	Box/Box/File
VST2418-57FFO	Storage Cabinet	File/File
VST2418-57BBFTR	Storage Cabinet	Box/Box/File
VST2418-57BBFTL	Storage Cabinet	Box/Box/File
VST2418-84FFTR	Storage Cabinet	File/File
VST2418-84FFTL	Storage Cabinet	File/File
VST2418-72FFTR	Storage Cabinet	File/File
VST2418-72FFTL	Storage Cabinet	File/File
VST2418-57FFTR	Storage Cabinet	File/File
VST2418-57FFTL	Storage Cabinet	File/File
VST2430-84WR	Wardrobe	(Right) Box/Box/File
VST2430-84WL	Wardrobe	(Left) Box/Box/File
VST2430-72WR	Wardrobe	(Right) Box/Box/File
VST2430-72WL	Wardrobe	(Left) Box/Box/File
VST2430-57WR	Wardrobe	(Right) Box/Box/File
VST2430-57WL	Wardrobe	(Left) Box/Box/File
VST2018-84BBFSSTR	Storage Cabinet	Box/Box/File
VST2018-84BBFSSTL	Storage Cabinet	Box/Box/File
VST2018-72BBFSSTR	Storage Cabinet	Box/Box/File
VST2018-72BBFSSTL	Storage Cabinet	Box/Box/File
VST2018-57BBFSSTR	Storage Cabinet	Box/Box/File
VST2018-57BBFSSTL	Storage Cabinet	Box/Box/File
VST2018-84FFSSTR	Storage Cabinet	File/File
VST2018-84FFSSTL	Storage Cabinet	File/File
VST2018-72FFSSTR	Storage Cabinet	File/File
VST2018-72FFSSTL	Storage Cabinet	File/File
VST2018-57FFSSTR	Storage Cabinet	File/File
VST2018-57FFSSTL	Storage Cabinet	File/File

Tall Storage Cabinets (continued):		Drawer Configuration
Model	Description	Single Pedestal Width
VST2018-84BBFO	Storage Cabinet	Box/Box/File
VST2018-84FFO	Storage Cabinet	File/File
VST2018-84BBFTR	Storage Cabinet	Box/Box/File
VST2018-84BBFTL	Storage Cabinet	Box/Box/File
VST2018-72BBFO	Storage Cabinet	Box/Box/File
VST2018-72FFO	Storage Cabinet	File/File
VST2018-72BBFTR	Storage Cabinet	Box/Box/File
VST2018-72BBFTL	Storage Cabinet	Box/Box/File
VST2018-57BBFO	Storage Cabinet	Box/Box/File
VST2018-57FFO	Storage Cabinet	File/File
VST2018-57BBFTR	Storage Cabinet	Box/Box/File
VST2018-57BBFTL	Storage Cabinet	Box/Box/File
VST2018-84FFTR	Storage Cabinet	File/File
VST2018-84FFTL	Storage Cabinet	File/File
VST2018-72FFTR	Storage Cabinet	File/File
VST2018-72FFTL	Storage Cabinet	File/File
VST2018-57FFTR	Storage Cabinet	File/File
VST20418-57FFTL	Storage Cabinet	File/File
VST2030-84WR	Wardrobe	(Right) Box/Box/File
VST2030-84WL	Wardrobe	(Left) Box/Box/File
VST2030-72WR	Wardrobe	(Right) Box/Box/File
VST2030-72WL	Wardrobe	(Left) Box/Box/File
VST2030-57WR	Wardrobe	(Right) Box/Box/File
VST2030-57WL	Wardrobe	(Left) Box/Box/File

Interior Drawer Dimensions	Depth	Width	Height
Box	15"	145/16"	31/4"
File	15"	145/16"	91/8"
Lateral File	15"	265/16"	91/8"

Filing Options (Diagram 3)

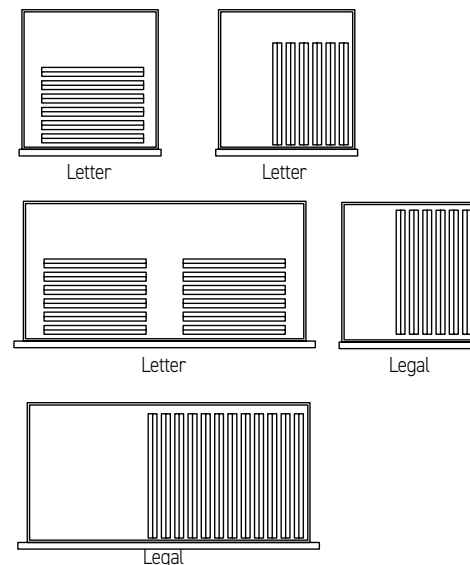



Vision Product Information

Modular Pedestals			Interior Drawer Dimensions									File Option
Model	Description	Drawer Configuration	Box			File			Lateral File			Diagram Reference #
			d	w	h	d	w	h	d	w	h	
VST1630MBBF	Desk Pedestal	Box/Box/File	21"	12"	3 1/4"	21"	12"	9 1/8"				1
VST1630MFF	Desk Pedestal	File/File		n/a		21"	12"	9 1/8"				1
VST1624MBBF	Credenza Pedestal	Box/Box/File	15"	12"	3 1/4"	15"	12"	9 1/8"				2
VST1624MFF	Credenza Pedestal	File/File		n/a		15"	12"	9 1/8"				2
VST3624MLF	Lateral File - 36" Wide	Lat. File/Lat. File		n/a			n/a		15"	32 5/16"	9 1/8"	5
VST3024MLF	Lateral File - 30" Wide	Lat. File/Lat. File		n/a			n/a		15"	26 5/16"	9 1/8"	6
VST3624MBSC	Buffet Credenza	2 Top Box Drawers	15"	14 3/4"	3 1/4"		n/a			n/a		n/a
VST1636MBBF	Desk Pedestal	Box/Box/File	21"	12"	3 1/4"	21"	12"	9 1/8"				1
VST1636MFF	Desk Pedestal	File/File		n/a		21"	12"	9 1/8"				1
VST1620MBBF	Credenza Pedestal	Box/Box/File	15"	12"	3 1/4"	15"	12"	9 1/8"				2
VST1620MFF	Credenza Pedestal	File/File		n/a		15"	12"	9 1/8"				2
VST3620MBSC	Buffet Credenza	2 Top Box Drawers	15"	14 3/4"	3 1/4"		n/a			n/a		n/a
VST3620MLF	Lateral File - 36" Wide	Lat. File/Lat. File		n/a			n/a		15"	32 5/16"	9 1/8"	5
VST3020MLF	Lateral File - 30" Wide	Lat. File/Lat. File		n/a			n/a		15"	26 5/16"	9 1/8"	6
VST3020MRM	Multi-File Pedestal	(right) Box/Box/File/Lat. File	15"	12"	3 1/4"	15"	12"	9 1/8"	15"	26 5/16"	9 1/8"	3
VST3020MLM	Multi-File Pedestal	(left) Box/Box/File/Lat. File	15"	12"	3 1/4"	15"	12"	9 1/8"	15"	26 5/16"	9 1/8"	3



**Vision Product Information****Finish and Reference Codes - Summary**

Select	Code	Select	Code	Select	Code
Essentials Veneer Collection		Wood Grain Laminates		Solid Wood Finishes	
Brickdust	BRK	Belair	BEL	Barrel	BAR
Cask	CSK	Brickdust	BRK	Brickdust	BRK
Clay	CLY	Cask	CSK	Buff	BUF
Fawn	FAW	Clay	CLY	Cask	CSK
Flax	FLX	Egret	EGR	Cinder	CND
Flint	FLN	Fawn	FAW	Clay	CLY
Loft	LOF	Flint	FLN	Egret	EGR
Mesa	MES	Florence Walnut	FLO	Fawn	FAW
Mineral	MIN	Loft	LOF	Flax	FLX
Mocha	MCH	Mesa	MES	Flint	FLN
Outback	OBK	Mineral	MIN	Florence Walnut	FLO
Pilsner	PIL	Mocha	MCH	Loft	LOF
Sienna	SIE	Outback	OBK	Mesa	MES
Truffle	TRF	Pilsner	PIL	Mineral	MIN
Umber	UMB	Pinnacle Walnut	PIN	Mocha	MCH
Valley	VAL	Umber	UMB	Outback	OBK
		Valley	VAL	Pilsner	PIL
		Walnut Heights	WLH	Pinnacle Walnut	PIN
Artisan Veneer Collection		Weathered Ash	WEA	Raven	RAV
Barrel	BAR			Rye	RYE
Buff	BUF			Sable	SAB
Cinder	CND	Solid Laminates		Saddle	SAD
Egret	EGR	Alabaster	ALB	Sienna	SIE
Raven	RAV	Black	BLK	Truffle	TRF
Rye	RYE	Bridal Blanco	BBL	Umber	UMB
Sable	SAB	Designer White	DWH	Valley	VAL
Saddle	SAD	Shadow	SHD	Walnut Heights	WLH
		Slate Grey	SLG		
		Zen Grey	ZEN	Neutral Paint Colors	
				Backdrop	BKD
				Black Fox	BFX
				Bright White	BWH
				Chatroom	CHT
				Gale Force	GAL
				Greek Villa	GRV
				Nonchalant White	NWH
				Silverplate	SVP
				Skyline Steel	SKS
				Storm	STM
				Tricorn Black	TRC
				Universal Khaki	UKH



**Vision Product Information****Finish and Reference Codes - Summary**

Select	Code
Pull (Delve & Prospect)	
Metal Finish Standard	
Aged Bronze	ABZ
Arctic Silver	ASL
Bright White	BWH
Gold	GLD
Matte Black	MBK
Pewter	PEW
Soft Bronze	SBZ
Soft Nickel	SNK

Pull (Delve & Prospect)
Metal Finish Upcharge - add \$50

Antique Linen	ANL
Blue Jean	BLJ
Candy Apple	CAP
Cashmere Beige	CAB
Copper Dust	CDU
Desert Stone	DST
Dusty Petal	DUP
Electric Blue	EBL
Emerald City	EMC
Evergreen Pine	EVP
Golden Honey	GOH
Midnight Whipser	MWH
Mustard Seed	MUS
Olive Fog	OLV
Porcelain White	POW
Space Cadet	SPA
Sparkling Peach	SPP
Spiced Raisin	SPR
Stormy Sky	SMK
Toffee Brown	TFB
Vintage Mahogany	VMA

Grommet Finish

Matte Black	MBK
Arctic Silver	ASL

Drawer Box

Wood Drawers	DRM001
Vinyl Wrapped Drawers	DRM002

Select	Code
Cantilever & Support	
Metal Finish Standard	
Aged Bronze	ABZ
Arctic Silver	ASL
Bright White	BWH
Gold	GLD
Matte Black	MBK
Pewter	PEW
Soft Bronze	SBZ
Soft Nickel	SNK

Cantilever & Support
Metal Finish Upcharge - add \$100

Antique Linen	ANL
Blue Jean	BLJ
Candy Apple	CAP
Cashmere Beige	CAB
Copper Dust	CDU
Desert Stone	DST
Dusty Petal	DUP
Electric Blue	EBL
Emerald City	EMC
Evergreen Pine	EVP
Golden Honey	GOH
Midnight Whipser	MWH
Mustard Seed	MUS
Olive Fog	OLV
Porcelain White	POW
Space Cadet	SPA
Sparkling Peach	SPP
Spiced Raisin	SPR
Stormy Sky	SMK
Toffee Brown	TFB
Vintage Mahogany	VMA

Select	Code
Overhead Cabinet Doors - Glass Options	
Frosted - Aluminum Frame	
White Back Painted - Aluminum	
Frm	
Clear - Wood Frame	

Adjustable Height Table Base Finish

Electric	
Matte Black	MBK
Arctic Silver	ASL
White	WH

Pneumatic

Alloy	ALY
Matte Black	MBK



Vision Product Information

Commonly Requested Modifications:	Price
Material/Finish	
Low sheen finish on veneer models5% Upcharge
Upgrade HPL worksurface to Black Matte HPL - Wilsonart Traceless 15505-31	Add \$28/SQ FT Top width (inches) x top length (inches)/144 = sq ft per top
JSI solid color powdercoat	
Fixed height metal leg (per model #)	Add \$65 list for any of the JSI extended powdercoat bright colors
Drawer pull (per pull)	Add \$65 list for any of the JSI extended powdercoat bright colors
Top grommet cap (per grommet)	Add \$65 list for any of the JSI extended powdercoat bright colors
Size or Configuration	
Size change - increase or decrease width 6" or less	Add 20% list
Units not to exceed 96" wide	
TFL, HPL, veneer width only; must not affect drawer size, Glass or metal components	
Change modular lateral file pedestal to BBF drawer config.	Add \$206 list
Soft close hinges	Add \$44 list per door
Soft close drawers (not available for lateral file)	Add \$97 list per Drawer
Additional Access Cutouts	
Worksurface grommet in non-standard location (contact customer service for approval of location)	Add \$123 list per location
10" x 10" wall access cut out in modesty panel	Add \$218 list
Door cabinet back panel ventilation	
For 1 or 2 door cabinet (single cavity cabinet)	Add \$370 list
For 3 or 4 door cabinet (two cavity cabinet)	Add \$496 list



CORPORATE OFFICE
225 CLAY STREET
JASPER, INDIANA 47546



800.457.4511 **TOLL FREE**
812.482.3204 **OFFICE**
812.482.1548 **FAX**



JSIFURNITURE.COM



CONTACT JSI