

Cāav Seating Order Check List:

1 Model Number

2 Wood Species

Standard Maple (M); Premium - Walnut (W) or White Oak (O); upcharge applies

3 Wood Finish/Paint Color Options:

Maple Frame		Walnut Frame		White Oak Frame		Paint Color					
BAR	Barrel	MCH	Mocha	BRK	Brickdust	BAR	Barrel	BKD	Backdrop	NVL	Novel Lilac
BRK	Brickdust	OBK	Outback	CSK	Cask	BUF	Buff	BFX	Black Fox	PPL	Patchwork Plum
BUF	Buff	PIL	Pilsner	MES	Mesa	CSK	Cask	BRV	Bravado Red	PGR	Pewter Green
CSK	Cask	PIN	Pinnacle Walnut	MCH	Mocha	CND	Cinder	BWH	Bright White	QAL	Queen Anne Lilac
CND	Cinder	RAV	Raven	PIN	Pinnacle Walnut	EGR	Egret	BRF	Broccoflower	RPT	Redend Point
CLY	Clay	RYE	Rye	SIE	Sienna	FAW	Fawn	BTT	Butternut	ROS	Rose Tan
EGR	Egret	SAB	Sable	TRF	Truffle	FLN	Flint	CCY	Canyon Clay	SAU	Saucy Gold
FAW	Fawn	SAD	Saddle	UMB	Umber	LOF	Loft	CHT	Chatroom	SVP	Silverplate
FLX	Flax	SIE	Sienna			MIN	Mineral	DEN	Denim	SKS	Skyline Steel
FLN	Flint	TRF	Truffle			RAV	Raven	GAL	Gale Force	STM	Storm
FLO	Florence Walnut	UMB	Umber			RYE	Rye	GRV	Greek Villa	TRC	Tricorn Black
LOF	Loft	VAL	Valley			SAB	Sable	KGR	Kendal Green	UKH	Universal Khaki
MES	Mesa	WLH	Walnut Heights			SAD	Saddle	NWH	Nonchalant White	WBL	Windy Blue
MIN	Mineral					UMB	Umber				

4 Fabric Selection

Please supply the following:

- Fabric vendor/Pattern name/Pattern color
- [View all JSI Standard and Graded-In Textiles](#)
- Indicate direction of fabric - Railroaded or Up the Roll
- Please provide illustration, if available

All COM orders must include the following:

- Vendor's name, pattern name and color
- Sample of the fabric attached to the order
- Model numbers of items for fabric application
- Special application instructions
- Customer and purchase order number

Ship prepaid COM material to:

JSI
Attn: COM Department
201 East Martin Street
Receiving B, Dock 71
Orleans, IN 47452

All COM orders will ship at standard lead time from receipt of COM except for orders requiring special custom matched finishes.

Application of fabric:



Seating:
Up the Roll



Privacy Screens: Railroad
*Leather unavailable



Corner Units:
Seat surfaces run diagonal

Cāav Seating Order Check List (continued):

5 Metal Color:

JSI's extended powdercoat program of bright colors is available, upon request. Contact Customer Service for a specific quote based on qty of units.

CLA Classic				DSG Designer							
ABZ	Aged Bronze	PEW	Pewter	TBF	Toffee Brown	SPR	Spiced Raisin	EMC	Emerald City	CDU	Copper Dust
ASL	Arctic Silver	PAM	Polished Aluminum	CAB	Cashmere Beige	CAP	Candy Apple	MWH	Midnight Whisper	SPP	Sparkling Peach
GLD	Gold	SBZ	Soft Bronze	SMK	Stormy Sky	GOH	Golden Honey	BLJ	Blue Jean	EBL	Electric Blue
MBK	Matte Black	SNK	Soft Nickel	DST	Desert Stone	MUS	Mustard Seed	SPA	Space Cadet		
				ANL	Antique Linen	OLV	Olive Fog	DUP	Dusty Petal		
				POW	Porcelain White	EVP	Evergreen Pine	VMA	Vintage Mahogany		

6 Optional Tablet Arm:

All arms on Freestanding, Modular and Sectional units are available with an optional tablet arm. The double-pivot mechanism allows the surface to be placed closer to the user. The recommended weight limit for the tablet is 75lbs.

Specify Tablet Arm Left (TBL), Right (TBR), or (TBB)
Veneer tablet arm matches wood finish selected

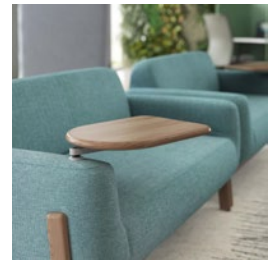

HPL Wood Grain Pattern Laminates

BEL	Belair	MES	Mesa
BAR	Barrel	MIN	Mineral
BRK	Brickdust	MCH	Mocha
CSK	Cask	OBK	Outback
CLY	Clay	PIL	Pilsner
EGR	Egret	PIN	Pinnacle Walnut
FAW	Fawn	UMB	Umber
FLN	Flint	VAL	Valley
FLO	Florence Walnut	WLH	Walnut Heights
LOF	Loft	WEA	Weathered Ash

HPL Solid Laminates

ALB	Alabaster
BLK	Black
BBL	Bridal Blanco
DWH	Designer White
SHD	Shadow
SLG	Slate Grey
ZEN	Zen Grey

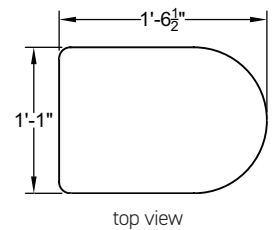

7 Optional Power:

Specify location as seated in right (PUR) or left (PUL), and select color choice of Black (B) or White (W).
In ottomans, specify Back (PUBK), Front (PUFR) or Both (PUB).

Cāav Desk Pod Order Check List:

1 Model Number

2 Fabric Selection:

Please supply the following:

- Fabric vendor/Pattern name/Pattern color
[View all JSI Standard and Graded-In Textiles](#)
- Indicate direction of fabric - Railroaded or Up the Roll
 - Please provide illustration, if available

All COM orders must include the following:

- Vendor's name, pattern name and color
- Sample of the fabric attached to the order
- Model numbers of items for fabric application
- Special application instructions
- Customer and purchase order number

Ship prepaid COM material to:

JSI
 Attn: COM Department
 201 East Martin Street
 Receiving B, Dock 71
 Orleans, IN 47452

All COM orders will ship at standard lead time from receipt of COM except for orders requiring special custom matched finishes.

3 Desk Material:

Laminate (L) or Veneer (V) Laminate with PVC Edge

HPL Wood Grain Pattern Laminates

BEL	Belair	MIN	Mineral
BRK	Brickdust	MCH	Mocha
CSK	Cask	OBK	Outback
CLY	Clay	PIL	Pilsner
EGR	Egret	PIN	Pinnacle Walnut
FAW	Fawn	UMB	Umber
FLN	Flint	VAL	Valley
FLO	Florence Walnut	WLH	Walnut Heights
LOF	Loft	WEA	Weathered Ash
MES	Mesa		

HPL Solid Laminates

ALB	Alabaster
BLK	Black
BBL	Bridal Blanco
DWH	Designer White
SHD	Shadow
SLG	Slate Grey
ZEN	Zen Grey

ESS Essentials Veneer Collection with Bullnose Edge

BRK	Brickdust	MIN	Mineral
CSK	Cask	MCH	Mocha
CLY	Clay	OBK	Outback
FAW	Fawn	PIL	Pilsner
FLX	Flax	SIE	Sienna
FLN	Flint	TRF	Truffle
LOF	Loft	UMB	Umber
MES	Mesa	VAL	Valley

ART Artisan Veneer Collection with Bullnose Edge

BAR	Barrel
BUF	Buff
CND	Cinder
EGR	Egret
RAV	Raven
RYE	Rye
SAD	Sable
SAD	Saddle

3a Leg Selection:

Solid Wood Finishes

BAR	Barrel	FLN	Flint	RYE	Rye
BRK	Brickdust	FLO	Florence Walnut	SAB	Sable
BUF	Buff	LOF	Loft	SAD	Saddle
CSK	Cask	MES	Mesa	SIE	Sienna
CND	Cinder	MIN	Mineral	TRF	Truffle
CLY	Clay	MCH	Mocha	UMB	Umber
EGR	Egret	OBK	Outback	VAL	Valley
FAW	Fawn	PIL	Pilsner	WLH	Walnut Heights
FLX	Flax	PIN	Pinnacle Walnut		
		RAV	Raven		

Paint Color

BKD	Backdrop	GAL	Gale Force	SAU	Saucy Gold
BFX	Black Fox	GRV	Greek Villa	SVP	Silverplate
BRV	Bravado Red	KGR	Kendal Green	SKS	Skyline Steel
BWH	Bright White	NWH	Nonchalant White	STM	Storm
BRF	Broccoflower	NVL	Novel Lilac	TRC	Tricorn Black
BTT	Butternut	PPL	Patchwork Plum	UKH	Universal Khaki
CCY	Canyon Clay	PGR	Pewter Green	WBL	Windy Blue
CHT	Chatroom	QAL	Queen Anne Lilac		
DEN	Denim	RPT	Redend Point		
		ROS	Rose Tan		

Cāav Desk Pod Order Check List (continued):

4 Metal Color:

JSI's extended powdercoat program of bright colors is available, upon request. Contact Customer Service for a specific quote based on qty of units.

CLA Classic			DSG Designer								
ABZ	Aged Bronze	PEW	Pewter	TBF	Toffee Brown	SPR	Spiced Raisin	EMC	Emerald City	CDU	Copper Dust
ASL	Arctic Silver	PAM	Polished Aluminum	CAB	Cashmere Beige	CAP	Candy Apple	MWH	Midnight Whisper	SPP	Sparkling Peach
GLD	Gold	SBZ	Soft Bronze	SMK	Stormy Sky	GOH	Golden Honey	BLJ	Blue Jean	EBL	Electric Blue
MBK	Matte Black	SNK	Soft Nickel	DST	Desert Stone	MUS	Mustard Seed	SPA	Space Cadet		
				ANL	Antique Linen	OLV	Olive Fog	DUP	Dusty Petal		
				POW	Porcelain White	EVP	Evergreen Pine	VMA	Vintage Mahogany		

5 Optional Power:

Specify color choice of Black (B) or White (W)

Cāav Lounge Specifications

Edge Profile

All veneer desks, tables, stand-up surfaces and tablet arms have a bullnose edge detail. The edge is solid lumber. All laminate desks, tables, stand-up surfaces and tablet arms have a matching PVC eased edge.

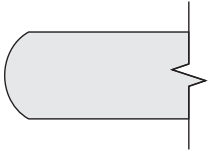

Bullnose Edge

Standard on veneer worksurface tops



Eased Edge (R3)

Standard on laminate worksurface tops

Lounge Scale

Freestanding, single seat lounge units are available in two sizes. Grand scale units offer generous comfort and accommodate a variety of lounge postures. Standard scale units offer the same comfort level in a smaller footprint and are more manageable to handle & install.

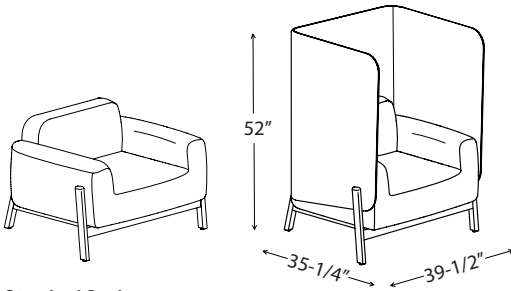

Standard Scale

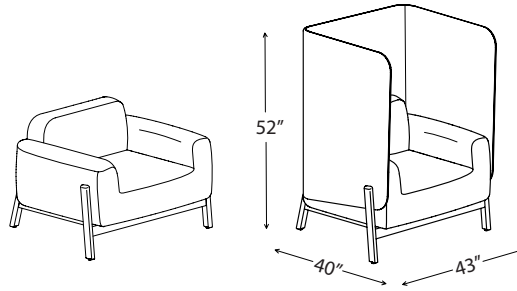

Grand Scale

Note: Units with Privacy Surrounds may not fit through standard building doorways.

H-brackets

Privacy Hoods and Privacy Wings attach in the field with H-Brackets. The metal color selected on each seating unit will apply to these brackets.



Aged Bronze, Matte Black & Pewter
 Brackets will have black bolts
 Arctic Silver, Soft Bronze, Gold & Soft
 Nickel Brackets will have nickel bolts



CORPORATE OFFICE
 225 CLAY STREET
 JASPER, INDIANA 47546



800.457.4511 **TOLL FREE**
 812.482.3204 **OFFICE**
 812.482.1548 **FAX**



JSIFURNITURE.COM



CONTACT JSI

Cāav Lounge Specifications

Modular linking bracket

Linking brackets are installed on Modular and Sectional seating units. These brackets are gravity-engaged and are intended to help link and align adjacent units. Brackets can be removed on exposed ends.

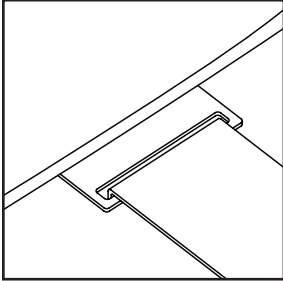

Leg-based Modular units connect with other Leg-based Modular units on ends without arms.



Sectional units connect with other Sectional units on ends without arms.

Lighting

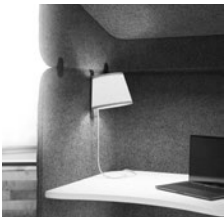

Sconce Lamp

- Accessory sconce
- Cord-mounted rocker switch
- 15' - three prong Graphite fabric power cord
- Field installed
- Maximum 60 watt light bulb, NOT included/LED bulb recommended

Power



EC46 - FlushMount

- Integrated simplex receptacle and two USB-A/9' - three prong Graphite fabric power cord/factory installed.
- Order as option, specify Black (B) or White (W).



EC47 - Under/Side Mount

- Simplex receptacle and two USB-A/9' - three prong Graphite fabric power cord/field installed.
- Mounts under table surface or to side of armless modular seat.
- Order separately, specify Black (B) or White (W).

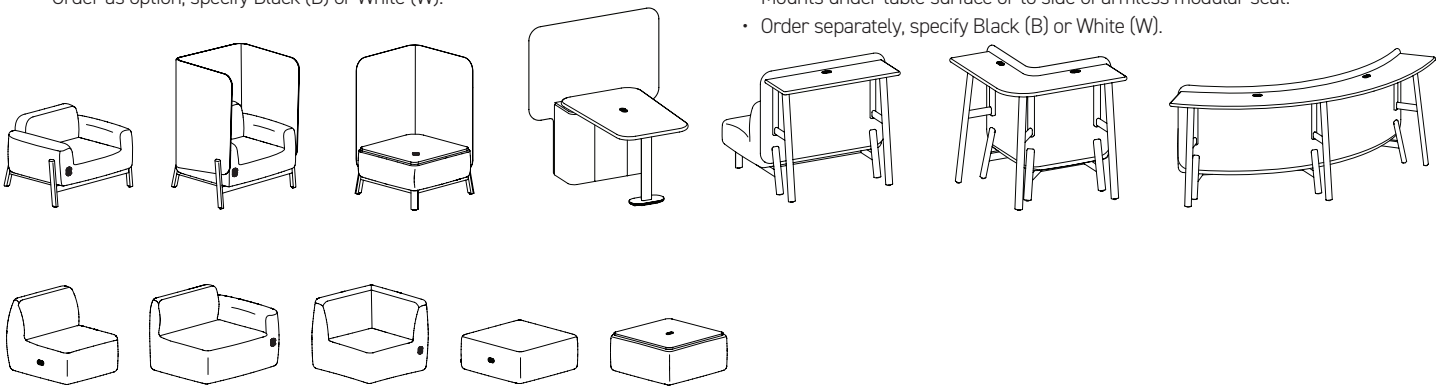

CORPORATE OFFICE
225 CLAY STREET
JASPER, INDIANA 47546



800.457.4511 **TOLL FREE**
812.482.3204 **OFFICE**
812.482.1548 **FAX**



JSIFURNITURE.COM



CONTACT JSI

Cāav Lounge Specifications

Contrasting Upholstery

Units with privacy elements can be specified with contrasting upholstery. When specified, the unit will be priced based on the highest grade fabric selected. Specify the (A) chair fabric and (B) privacy fabric on your order.

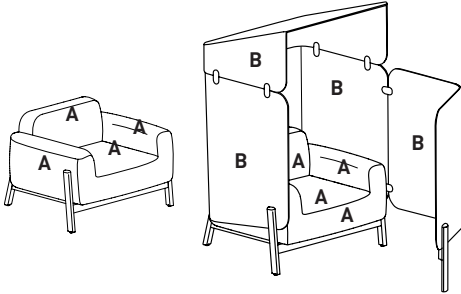

Upholstery Detail - False Welt

False Welt - Double fold upholstery seam detail is present on Caav privacy screens. An integral part of the upholstery application, the false welt creates a defined line while maintaining flexibility for ultimate casual comfort.

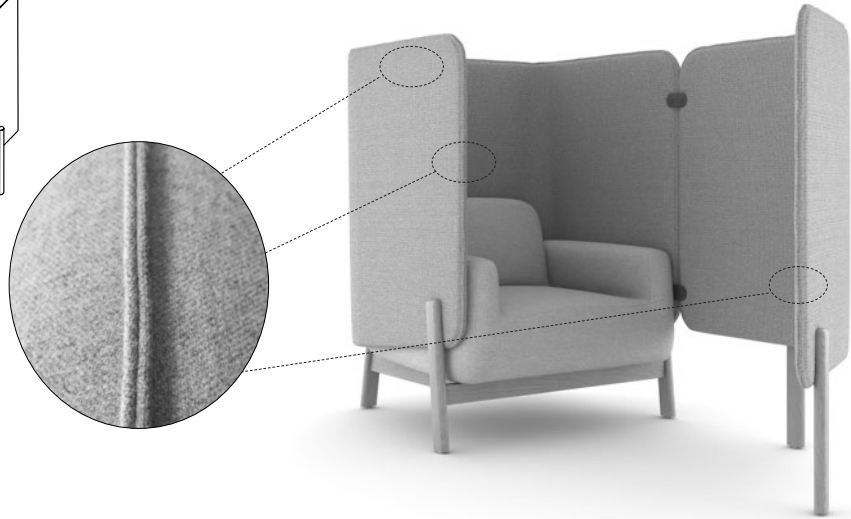

Note: Large scale and geometric patterns applied over Caav's soft contours and false welt details will impact the pattern visual. Solid colors are recommended, particularly on the seating.



CORPORATE OFFICE
225 CLAY STREET
JASPER, INDIANA 47546



800.457.4511 **TOLL FREE**
812.482.3204 **OFFICE**
812.482.1548 **FAX**



JSIFURNITURE.COM



CONTACT JSI