

ANTHOLOGY

planning guide + pricelist

effective January 19, 2026



Table of Contents

| | |
|------------------------------------|-----|
| Statement of Line | 3 |
| Product and Finish Information | 5 |
| Power and Cutout Information | 13 |
| Planning Guide | |
| Specification Overview | 14 |
| Table Top Specification | 15 |
| Base Specification | 16 |
| Seating Capacity | 26 |
| Base Placement Dimensions | 27 |
| Table Top Power Overview | 29 |
| Power Types & Top Cutout Locations | 30 |
| Cutout Location Guide | 31 |
| Table Top Power Options | 36 |
| Wiremanagement Accessories | 49 |
| Credenza Model Types & Features | 50 |
| Credenza Specification Overview | 53 |
| Credenza Exterior Components | 55 |
| Credenza Interior Dimensions | 56 |
| How to Order Tops | 59 |
| Price List | |
| Table Tops | 60 |
| Table Base Kits | 85 |
| Single Table Bases | 99 |
| Power & Data | 106 |
| Credenzas | 119 |
| Power Credenzas | 125 |



Statement of Line

Table Tops

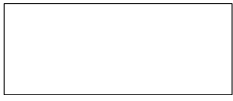

Rectangular

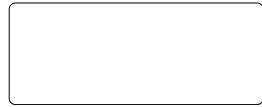

Soft Rectangular



Arc Rectangular



Boat

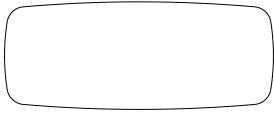

Arc Boat



Racetrack

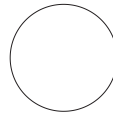

Round

Table Base Kits

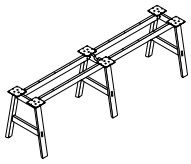

Bridge

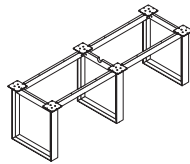

Bevel

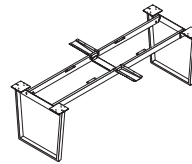

Frame BridgeLine

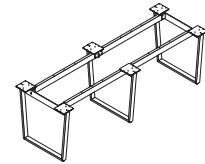

Frame

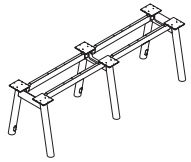

Oblique

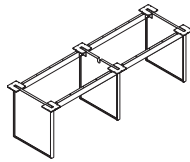

Outline

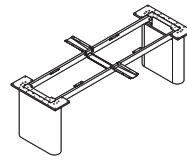

Racetrack BridgeLine

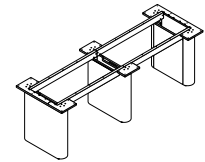

Racetrack

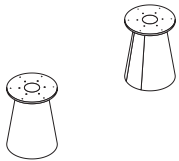

Conical

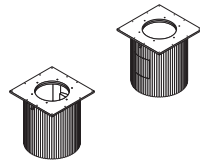

Fluted

Single Table Bases



Conical

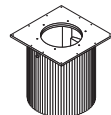

Fluted

Power Table Bases

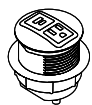

Node

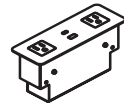

Electrolite



Ellora

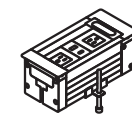

Vault Z23



M2X

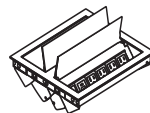

Ellora Double

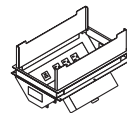

Oasis

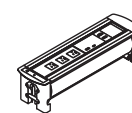

Vault BTC

Statement of Line

Credenzas

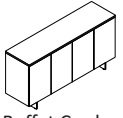

Buffet Credenza with Base

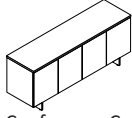

Conference Credenza with Base

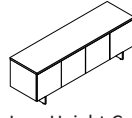

Low Height Credenza with Base

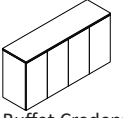

Buffet Credenza

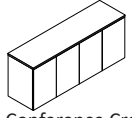

Conference Credenza

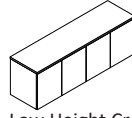

Low Height Credenza

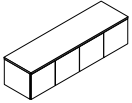

Wall Mount Credenza

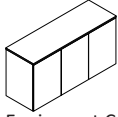

Equipment Credenza

Power Credenzas

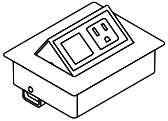

Glenbeigh

Product and Finish Information

Exterior Wood Materials

Exterior surfaces are made from the finest selected veneers to achieve clarity and consistency in the Anthology Veneer product line. To attain a pleasing, symmetrical pattern, all cherry, maple, walnut veneers in Anthology Veneer are book-matched. All exterior solid lumber is matched to coordinate with the veneer.

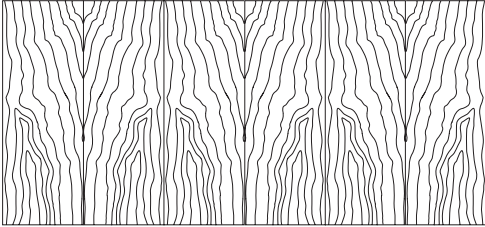

Book-Matched Example

Alternating pieces of veneer are flipped over so they face each other like the pages within a book

Anthology Veneer is available in flat cut cherry, maple, walnut and black oak veneer. A wide range of wood stains have been formulated to enhance the beauty of the veneer.

Double Cut veneer is another choice on Anthology Veneer product. This veneer is a processed product that has at least two cuttings to create the final veneers. These cuts of veneer strands are dyed and layered into a block to create variation of patterns from a very tight grain pattern to an exotic figure grain pattern. The diagram below show the tight pattern used on Anthology Veneer. Use the appropriate pricing column when specifying Double Cut veneer.

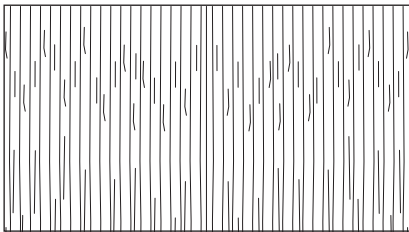

Protective Top Coat

DuraTex™ offers exceptional hardness along with abrasion and impact resistance, it has been formulated to eliminate hazardous and harmful gases that are normally associated with wood finish.

DuraTex™ Features

Safety- Significantly reduces hazardous formaldehyde emissions which help improve the quality of the of the indoor air we breathe. Quality- Developed to be tough and durable with special attention to appearance. The DuraTex™ finish preserves the natural beauty of wood. Durability- Designed to meet a wide range of demanding performance and environmental standards to withstand even the highest wear and tear.

Finish Sheen

All veneer finishes are standard in 35-sheen, with the exception of Raven. Raven is only offered in 15-sheen. All other finishes are available in 15-sheen.

Custom/Special Finishes

JSI, upon request, will accommodate special finishes. A written request is required to proceed with custom finish orders. A sample reference is required for first-time matches and must be included with the written request.

There is a one-time charge of **\$412 list per order** for any non-standard wood finish.

Orders will be entered noting the special finish. A sample match will be provided to the customer. Written approval is needed before the finish process can be started. Delays in approval may have an impact on lead times.

Every effort will be made to create the requested match; however, an acceptable match may not be possible because of natural variations of wood. These natural variations can also cause minor differences in the final finish product.

Use standard pricing and option pricing for each line item with a special finish, unless additional modifications have been specified. For items available in both Essential and Artisan veneers, apply the Essentials pricing.

Product and Finish Information

Laminates

Anthology Laminate features TFL (thermally fused laminate) chassis and components.

Edges of the worksurface are impact resistant (PVC) on TFL tops. The laminate is offered in 19 wood grain patterns and 7 solid colors. The wood grain laminate features an embossed grain to hide finger prints and light scratches. The solid laminate is smooth to the touch with a semi-matte finish.

Credenza Top Surfaces

Tops have a $\frac{3}{4}$ " top panel thickness and a .5mm edgeband.

TFL features on Surfaces*

- fused to the 45 pound density substrate of the top for a durable wear resistance surface
- tops are laminated on both sides
- available in all the wood grain and solid patterns

Credenza Case Construction

Outside panels are $\frac{3}{4}$ " and joined together with dowels reinforced with screws, and metal fasteners for increased stability. Tops are secured to the chassis with screws through pre-bored stretcher rails and pocket holes.

Cabinet doors have 110° swing hinges to allow adequate access into the interior of the cabinet.

Unfinished back, includes cutout in back side for wire management pass through.

Locking

Locks are available per door set for \$53.

When locks are ordered, units are shipped randomly keyed as standard. Key alike units are available upon request for no additional charges. Removable cores for in-field re-keying are standard.

Product and Finish Information

Credenzas

TFL Laminates

| | |
|-----|-----------------|
| ALB | Alabaster |
| BEL | Belair |
| BLK | Black |
| BRK | Brickdust |
| BBL | Bridal Blanco |
| CSK | Cask |
| CLY | Clay |
| DWH | Designer White |
| EGR | Egret |
| FAW | Fawn |
| FLN | Flint |
| FLO | Florence Walnut |
| LOF | Loft |
| MES | Mesa |
| MIN | Mineral |
| MCH | Mocha |
| OBK | Outback |
| PIL | Pilsner |
| PIN | Pinnacle Walnut |
| SHD | Shadow |
| SLG | Slate Grey |
| UMB | Umber |
| VAL | Valley |
| WLH | Walnut Heights |
| WEA | Weathered Ash |
| ZEN | Zen Grey |

Veneer

ESS Essentials Veneer

| | |
|-----|-----------|
| BRK | Brickdust |
| CSK | Cask |
| CLY | Clay |
| FAW | Fawn |
| FLX | Flax |
| FLN | Flint |
| LOF | Loft |
| MES | Mesa |
| MIN | Mineral |
| MCH | Mocha |
| OBK | Outback |
| PIL | Pilsner |
| SIE | Sienna |
| TRF | Truffle |
| UMB | Umber |
| VAL | Valley |

ART Artisan Veneer

| | |
|-----|--------|
| BAR | Barrel |
| BUF | Buff |
| CND | Cinder |
| EGR | Egret |
| RAV | Raven |
| RYE | Rye |
| SAB | Sable |
| SAD | Saddle |

Paint - Door Fronts ONLY-

| | |
|-----|------------------|
| BKD | Backdrop |
| BFX | Black Fox |
| BRV | Bravado Red |
| BWH | Bright White |
| BRF | Broccoflower |
| BTT | Butternut |
| CCY | Canyon Clay |
| CHT | Chatroom |
| DEN | Denim |
| GAL | Gale Force |
| GRV | Greek Villa |
| KGR | Kendal Green |
| NWH | Nonchalant White |
| NVL | Novel Lilac |
| PPL | Patchwork Plum |
| PGR | Pewter Green |
| QAL | Queen Anne Lilac |
| RPT | Redend Point |
| ROS | Rose Tan |
| SAU | Saucy Gold |
| SVP | Silverplate |
| SKS | Skyline Steel |
| STM | Storm |
| TRC | Tricorn Black |
| UKH | Universal Khaki |
| WBL | Windy Blue |

Solid Wood

| | |
|-----|-----------------|
| BAR | Barrel |
| BRK | Brickdust |
| BUF | Buff |
| CSK | Cask |
| CND | Cinder |
| CLY | Clay |
| EGR | Egret |
| FAW | Fawn |
| FLX | Flax |
| FLN | Flint |
| FLO | Florence Walnut |
| LOF | Loft |
| MES | Mesa |
| MIN | Mineral |
| MCH | Mocha |
| OBK | Outback |
| PIL | Pilsner |
| PIN | Pinnacle Walnut |
| RAV | Raven |
| RYE | Rye |
| SAB | Sable |
| SAD | Saddle |
| SIE | Sienna |
| TRF | Truffle |
| UMB | Umber |
| VAL | Valley |
| WLH | Walnut Heights |

Metal Inset Base

Metal Finish Standard

| | |
|-----|---|
| ABZ | Aged Bronze |
| ASL | Arctic Silver |
| BWH | Bright White |
| CHR | Chrome- upcharge applies- see pricing pages |
| GLD | Gold |
| MBK | Matte Black |
| PEW | Pewter |
| SBZ | Soft Bronze |
| SNK | Soft Nickel |

Metal Finish Upcharge - add \$52

| | |
|-----|------------------|
| ANL | Antique Linen |
| BLJ | Blue Jean |
| CAP | Candy Apple |
| CAB | Cashmere Beige |
| CDU | Copper Dust |
| DST | Desert Stone |
| DUP | Dusty Petal |
| EBL | Electric Blue |
| EMC | Emerald City |
| EVP | Evergreen Pine |
| GOH | Golden Honey |
| MWH | Midnight Whisper |
| MUS | Mustard Seed |
| OLV | Olive Fog |
| POW | Porcelain White |
| SPA | Space Cadet |
| SPP | Sparkling Peach |
| SPR | Spiced Raisin |
| SMK | Stormy Sky |
| TFB | Toffee Brown |
| VMA | Vintage Mahogany |

Product and Finish Information

Laminate

Table Top Models

The Anthology suffix T, H or KH is used to designate laminate material.

Laminate Tops

Anthology features 1 1/8" thick TFL (thermally fused laminate) and 1 3/8" thick HPL (high pressure laminate) table top surfaces with PVC rim; see table top specification [page 15](#).

Top Profile

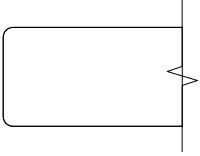

Eased (R3)
suffix **T**

TFL Laminates

- ALB Alabaster
- BBL Bridal Blanco
- BEL Belair
- BLK Black
- BRK Brickdust
- CSK Cask
- CLY Clay
- DWH Designer White
- EGR Egret
- FAW Fawn
- FLN Flint
- FLO Florence Walnut
- LOF Loft
- MES Mesa
- MIN Mineral
- MCH Mocha
- OBK Outback
- PIL Pilsner
- PIN Pinnacle Walnut
- SHD Shadow
- SLG Slate Grey
- UMB Umber
- VAL Valley
- WLH Walnut Heights
- WEA Weathered Ash
- ZEN Zen Grey



Eased (R3)
suffix **H**

Tier 1 - HPL Laminates

- ALB Alabaster
- BBL Bridal Blanco
- BEL Belair
- BLK Black
- BRK Brickdust
- CSK Cask
- CLY Clay
- DWH Designer White
- EGR Egret
- FAW Fawn
- FLN Flint
- FLO Florence Walnut
- LOF Loft
- MES Mesa
- MIN Mineral
- MCH Mocha
- OBK Outback
- PIL Pilsner
- PIN Pinnacle Walnut
- SHD Shadow
- SLG Slate Grey
- UMB Umber
- VAL Valley
- WLH Walnut Heights
- WEA Weathered Ash
- ZEN Zen Grey

Tier 2 Formica

[see page 9](#)

Tier 2 Wilsonart

[see page 10](#)

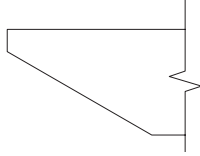

Reverse Bevel (K9)
suffix **KH**

Tier 1 - HPL Laminates

- ALB Alabaster
- BBL Bridal Blanco
- BEL Belair
- BLK Black
- BRK Brickdust
- CSK Cask
- CLY Clay
- DWH Designer White
- EGR Egret
- FAW Fawn
- FLN Flint
- FLO Florence Walnut
- LOF Loft
- MES Mesa
- MIN Mineral
- MCH Mocha
- OBK Outback
- PIL Pilsner
- PIN Pinnacle Walnut
- SHD Shadow
- SLG Slate Grey
- UMB Umber
- VAL Valley
- WLH Walnut Heights
- WEA Weathered Ash
- ZEN Zen Grey

Tier 2 Formica

[see page 9](#)

Tier 2 Wilsonart

[see page 10](#)

Tier 2 Laminates require the additional specification of a PVC edge band. Choose from one of the following JSI standard options, [see page 10](#).



Formica Laminate

Anthology Table Tops offer an extensive program for laminates beyond our Standard Program. Always reference below the most current listing and tier pricing when using a Graded-In Laminate; on [page 10](#) select the color of the PVC edge color.

| Laminate | Pattern-Sheen | Tier | Laminate | Pattern-Sheen | Tier | Laminate | Pattern-Sheen | Tier | Laminate | Pattern-Sheen | Tier |
|-------------------------|---------------|------|--------------------|---------------|------|------------------------|---------------|------|-----------------------|---------------|------|
| Acajou Mahogany | 7008-58 | 2 | Dark Chocolate | 2200-58 | 2 | Mineral Spa | 6920-58 | 2 | Slate Noir | 3711-58 | 2 |
| Aged Ash | 8844-58 | 2 | Denim | 8822-58 | 2 | Mission White | 933-58 | 2 | Smoke | 3245-58 | 2 |
| Algae | 8796-58 | 2 | Desert Beige | 899-58 | 2 | Mocha Travertine | 3456-58 | 2 | Smoke Onyx | 3710-58 | 2 |
| Almond | 920-58 | 2 | Dover White | 7197-58 | 2 | Mojave | 8751-58 | 2 | Smoke Quarstone | 6220-58 | 2 |
| Aluminum | 9318-58 | 2 | Earth | 5342-58 | 2 | Moonstone | 7872-58 | 2 | Smokey Brown Pear | 5488-58 | 2 |
| Amber Kashmir | 6227-58 | 2 | Earth Wash | 7213-58 | 2 | Mouse | 928-58 | 2 | Solar Orange | 8235-58 | 2 |
| Amber Maple | 7012-58 | 2 | Earthen Twill | 8828-58 | 2 | Muslin Fabric | 6127-58 | 2 | Sorrel Cherry | 5886-58 | 2 |
| Antique White | 932-58 | 2 | Earthen Warp | 5880-58 | 2 | Natural Ash | 8843-58 | 2 | Spectrum Blue | 851-58 | 2 |
| Argento Romano | 6697-58 | 2 | Earthenware | 8241-58 | 2 | Natural Birch | 7481-58 | 2 | Spectrum Green | 7897-58 | 2 |
| Artichoke | 800-58 | 2 | Earthenware | 6999-58 | 2 | Natural Canvas | 7022-58 | 2 | Spectrum Red | 845-58 | 2 |
| Ashwood Beige | 5785-58 | 2 | Brushstroke | | 2 | Natural Gray Felt | 4971-58 | 2 | Stainless | 9319-58 | 2 |
| Ashwood Bone | 5784-58 | 2 | Ebony | 9012-58 | 2 | Natural Maple | 756-58 | 2 | Star Dune | 9309-58 | 2 |
| Ashwood Oak | 5786-58 | 2 | Ebony Oxide | 299-58 | 2 | Natural Oak | 346-58 | 2 | Starched Paperfold | 8678-58 | 2 |
| Basalt Slate | 3690-58 | 2 | Elemental Concrete | 8830-58 | 2 | Natural Recycled Kraft | 9684-58 | 2 | Stone Grafix | 503-58 | 2 |
| Beige Elm | 5794-58 | 2 | Elemental Stone | 8831-58 | 2 | Natural Riftwood | 9282-58 | 2 | Stop Red | 839-58 | 2 |
| Belmonte Granite | 3496-58 | 2 | Espresso Pear | 5489-58 | 2 | Natural Teak | 8849-58 | 2 | Storm | 912-58 | 2 |
| Birchbark | 8684-58 | 2 | Finnish Oak | 118-58 | 2 | Navy Blue | 969-58 | 2 | Storm Solidz | 3505-58 | 2 |
| Black | 909-58 | 2 | Flax Gauze | 7708-58 | 2 | Navy Grafix | 7018-58 | 2 | Storm Teakwood | 8908-58 | 2 |
| Black Bardiglio | 5019-58 | 2 | Flint Crystal | 3518-58 | 2 | Neo Cloud | 6314-58 | 2 | Sugar Glass | 3705-58 | 2 |
| Black Birchply | 8552-58 | 2 | Fog | 961-58 | 2 | Neutral Twill | 8826-58 | 2 | Surf | 923-58 | 2 |
| Black Recycled Kraft | 9685-58 | 2 | Folkstone | 927-58 | 2 | Neutral Weft | 5875-58 | 2 | Swede Rift Oak | 8676-58 | 2 |
| Black Riftwood | 6414-58 | 2 | Folkstone Celesta | 692-58 | 2 | Neutral White | 918-58 | 2 | Taupe Walnut | 5787-58 | 2 |
| Black Shalestone | 9527-58 | 2 | Folkstone Grafix | 507-58 | 2 | New Burgundy | 7966-58 | 2 | Terril | 2297-58 | 2 |
| Black Walnut | 3485-58 | 2 | Formal Walnut | 5782-58 | 2 | Night Forest | 8244-58 | 2 | Thermo Walnut | 6402-58 | 2 |
| Blackened Fiberwood | 8916-58 | 2 | Fossil | 5349-58 | 2 | Night Shade | 8243-58 | 2 | Travertine | 3526-58 | 2 |
| Blackened Legno | 8848-58 | 2 | Fox Teakwood | 8907-58 | 2 | Noble Mahogany | 9236-58 | 2 | Tula Oak | 8589-58 | 2 |
| Blackened Steel | 8918-58 | 2 | Geriba Gray | 9308-58 | 2 | Nocturne | 5323-58 | 2 | Venetian Gold Granite | 6223-58 | 2 |
| Blackstone | 271-58 | 2 | Ginger Root Maple | 7288-58 | 2 | Noir Cedar | 1547-58 | 2 | Vibrant Green | 6901-58 | 2 |
| Bleached Legno | 8845-58 | 2 | Glamour Cherry | 6208-58 | 2 | Noir Envision | 7500-58 | 2 | Walnut Butcherblock | 3712-58 | 2 |
| Blond Cedar | 8576-58 | 2 | Glass Cloth | 8683-58 | 2 | Nut Brown Cherry | 5790-58 | 2 | Walnut Fiberwood | 8915-58 | 2 |
| Blossom Cherrywood | 758-58 | 2 | Gold Braze | 1193-58 | 2 | Oiled Legno | 8846-58 | 2 | Walnut Riftwood | 9283-58 | 2 |
| Blue Felt | 9320-58 | 2 | Graphite | 837-58 | 2 | Oiled Walnut | 5487-58 | 2 | Walnut Softwood | 4925-58 | 2 |
| Blush | 8238-58 | 2 | Graphite Elm | 5796-58 | 2 | Orange Felt | 4973-58 | 2 | Washi Paperfold | 8680-58 | 2 |
| Brazilian Brown Granite | 6222-58 | 2 | Graphite Grafix | 515-58 | 2 | Origami Paperfold | 8679-58 | 2 | Waxed Maple | 8905-58 | 2 |
| Brite White | 459-58 | 2 | Graphite Twill | 8829-58 | 2 | Otter | 3202-58 | 2 | Weathered Ash | 8842-58 | 2 |
| Bronzed Steel | 8919-58 | 2 | Gray Fabric | 6129-58 | 2 | Oxidized Beamwood | 9484-58 | 2 | Weathered Fiberwood | 8914-58 | 2 |
| Bubble Art | 8958-58 | 2 | Gray Grafix | 9300-58 | 2 | Oyster Grey | 929-58 | 2 | Wenge Strand | 6306-58 | 2 |
| Buff Elm | 5793-58 | 2 | Gray Onyx | 7409-58 | 2 | Pale Brushstroke | 6997-58 | 2 | Wheat Strand | 6212-58 | 2 |
| Burnished Coin | 3708-58 | 2 | Grayed Oak | 5791-58 | 2 | Paloma Polar | 6698-58 | 2 | White | 949-58 | 2 |
| Burnished Iron | 3709-58 | 2 | Graystone | 464-58 | 2 | Patine Bronze | 3707-58 | 2 | White Ash | 8841-58 | 2 |
| Burnt Strand | 6307-58 | 2 | Green Felt | 4974-58 | 2 | Patine Concrete | 3706-58 | 2 | White Bardiglio | 9306-58 | 2 |
| Butterum Granite | 7732-58 | 2 | Green Slate | 8793-58 | 2 | Pearl | 934-58 | 2 | White Drops | 8824-58 | 2 |
| Camel Elm | 5795-58 | 2 | Greige Softwood | 4924-58 | 2 | Pecan Walnut | 6996-58 | 2 | White Ice Granite | 9476-58 | 2 |
| Cardboard Solidz | 7813-58 | 2 | Gull Grey | 9242-58 | 2 | Pecan Woodline | 5883-58 | 2 | White Marble | 9310-58 | 2 |
| Carrara Bianco | 6696-58 | 2 | Hard Rock Maple | 86992-58 | 2 | Pencil Wood | 7747-58 | 2 | Herringbone | | 2 |
| Carrara Envision | 7494-58 | 2 | Hazel Walnut | 5788-58 | 2 | Perlato Granite | 3522-58 | 2 | White Onyx | 827-58 | 2 |
| Cascara Teakwood | 8909-58 | 2 | Ice Onyx | 7408-58 | 2 | Planked Coffee Oak | 7413-58 | 2 | White Painted Wood | 8902-58 | 2 |
| Cassia | 6903-58 | 2 | Inked Oak | 5792-58 | 2 | Planked Deluxe Pear | 6206-58 | 2 | White Pearl Cascade | 3720-58 | 2 |
| Ceruse Gray Walnut | 6994-58 | 2 | Ivory Kashmir | 6226-58 | 2 | Planked Raw Oak | 7412-58 | 2 | White Shalestone | 9525-58 | 2 |
| Chambray Fabric | 6130-58 | 2 | Jadeite | 1198-58 | 2 | Planked Urban Oak | 9312-58 | 2 | White Twill | 9285-58 | 2 |
| Charcoal Boomerang | 6942-58 | 2 | Jamocho Granite | 7734-58 | 2 | Platinum | 902-58 | 2 | White Washed Birchply | 6372-58 | 2 |
| Chelsea Maple | 9238-58 | 2 | Just Rose | 8858-58 | 2 | Portico Marble | 7735-58 | 2 | Wild Cherry | 5904-58 | 2 |
| Cherry Heartwood | 9240-58 | 2 | Labrador Granite | 3692-58 | 2 | Prestige Walnut | 6209-58 | 2 | Winter Sky | 8792-58 | 2 |
| Cherry Walnut | 6995-58 | 2 | Layered Black Sand | 9510-58 | 2 | Pumice | 858-58 | 2 | Wood Brushstroke | 6998-58 | 2 |
| Chestnut Woodline | 5884-58 | 2 | Layered Sand | 9511-58 | 2 | Purple Dye | 1196-58 | 2 | Woolen Cloth | 8682-58 | 2 |
| Chrome Yellow | 1485-58 | 2 | Layered White Sand | 9512-58 | 2 | Raw Birchply | 8910-58 | 2 | Yellow Felt | 4972-58 | 2 |
| Cinnamon Cherry | 8955-58 | 2 | Lime Stone | 7264-58 | 2 | Raw Cedar | 1545-58 | 2 | | | |
| Citadel | 1097-58 | 2 | Liquid Glass | 8240-58 | 2 | Sail White | 463-58 | 2 | | | |
| Citadel Warp | 5882-58 | 2 | Luxe Mango | 8685-58 | 2 | Sand Crystal | 3517-58 | 2 | | | |
| Classic White | 9244-58 | 2 | Macchiato Walnut | 6932-58 | 2 | Sand Maple | 9237-58 | 2 | | | |
| Clementine | 2962-58 | 2 | Maple Woodline | 6925-58 | 2 | Sarum Grey | 2770-58 | 2 | | | |
| Clove Spice Cherry | 5789-58 | 2 | Marine Blue | 914-58 | 2 | Sarum Twill | 8827-58 | 2 | | | |
| Cocoa Maple | 7739-58 | 2 | Marmara Beige | 7406-58 | 2 | Scandi Rift Oak | 8677-58 | 2 | | | |
| Cocoa Oak | 9374-58 | 2 | Marmara Gray | 7407-58 | 2 | Sea Salt | 9529-58 | 2 | | | |
| Cognac Maple | 7738-58 | 2 | Matrix Blue | 8795-58 | 2 | Seasoned Planked Elm | 6477-58 | 2 | | | |
| Concrete Formwood | 6362-58 | 2 | Mdf Solidz | 7812-58 | 2 | Select Cherry | 7759-58 | 2 | | | |
| Concrete Stone | 7267-58 | 2 | Midnight Stone | 6280-58 | 2 | Sheer Fabric | 6126-58 | 2 | | | |
| Cotton Cloth | 8681-58 | 2 | Milk | 9634-58 | 2 | Silver Quartzite | 9497-58 | 2 | | | |
| Cream Softwood | 4923-58 | 2 | Millennium Oak | 5887-58 | 2 | Silver Riftwood | 6413-58 | 2 | | | |
| Danish Maple | 8906-58 | 2 | Mineral Jet | 3450-58 | 2 | Silver Shalestone | 9307-58 | 2 | | | |

Wilsonart Laminate

Anthology Table Tops offer an extensive program for laminates beyond our Standard Program. Always reference below the most current listing and tier pricing when using a Graded-In Laminate; see below on the PVC edge color selection.

| Laminate | Pattern-Sheen | Tier | Laminate | Pattern-Sheen | Tier | Laminate | Pattern-Sheen | Tier | Laminate | Pattern-Sheen | Tier |
|--------------------|---------------|------|-------------------|---------------|------|------------------|---------------|------|------------------|---------------|------|
| Almond Leather | 2932-60 | 2 | Florence Walnut | 7993-38 | 2 | Lowell Ash | 7994-38 | 2 | Port | D14-60 | 2 |
| Anitique White | 1572-60 | 2 | Fonthill Pear | 10745-60 | 2 | Mangalore Mango | 7984-38 | 2 | Pressed Linen | 4991-38 | 2 |
| Anzio Marble | 5037-38 | 2 | Forged Steel | 4995-60 | 2 | Manitoba Maple | 7911-60 | 2 | Raw Cotton | 4947-38 | 2 |
| Atlantis | D25-60 | 2 | Fossil Shale | D504-60 | 2 | Midnight | D505-60 | 2 | River Cherry | 7937-38 | 2 |
| Bannister Oak | 7806-60 | 2 | French Linen | 5016-38 | 2 | Mission Maple | 7990-38 | 2 | Rustic Slate | 4888-38 | 2 |
| Beige | 1530-60 | 2 | French Pear | 8220-38 | 2 | Misted Zephyr | 4843-60 | 2 | Sable Soapstone | 4883-38 | 2 |
| Beigewood | 7850-60 | 2 | Frosty White | 1573-60 | 2 | Monticello Maple | 7925-38 | 2 | Sap Walnut | 8221-38 | 2 |
| Boardwalk Oak | 7983-38 | 2 | Fusion Maple | 7909-60 | 2 | Morelia Maple | 7985-38 | 2 | Shadow Zephyr | 4857-60 | 2 |
| Brazilwood | 7946-38 | 2 | Graphite | 10657-60 | 2 | Morro Zephyr | 4846-60 | 2 | Sheer Mesh | 4876-38 | 2 |
| Brittany Blue | D321-60 | 2 | Graphite Nebula | 4623-60 | 2 | Natural Almond | D30-60 | 2 | Sierra Cascade | 5005-38 | 2 |
| Bronze Legacy | 4656-60 | 2 | Green Tigris | 4667-60 | 2 | Natural Cotton | 4946-38 | 2 | Silicon Ev | 4811-60 | 2 |
| Buka Bark | 7982-38 | 2 | Grey | 1500-60 | 2 | Natural Recon | 7996-38 | 2 | Solar Oak | 7816-60 | 2 |
| Burnished Chestnut | 4796-60 | 2 | Grey Glace | 4142-60 | 2 | Natural Rift | 7954-38 | 2 | Steel Mesh | 4879-38 | 2 |
| Candy Apple | 13096-60 | 2 | Grey Mesh | 4877-38 | 2 | Natural Tigris | 4669-60 | 2 | Sterling Ash | 7995-38 | 2 |
| Canyon Zephyr | 4842-60 | 2 | Grey Nebula | 4622-60 | 2 | Navy Legacy | 4651-60 | 2 | Sunny Side Up | 13089-60 | 2 |
| Carbon Ev | 4820-60 | 2 | Grey Pampas | 4168-60 | 2 | Neo Walnut | 7991-38 | 2 | Tailored Linen | 4992-38 | 2 |
| Carbon Mesh | 4880-60 | 2 | Gumball | 13102-60 | 2 | Neutral Glace | 4143-60 | 2 | Titanium EV | 4810-60 | 2 |
| Castle Oak | 7928-38 | 2 | Handspun Chestnut | 5036-38 | 2 | New Age Oak | 7938-38 | 2 | Tungsten EV | 4814-60 | 2 |
| Casual Linen | 4944-38 | 2 | Handspun Dove | 5034-38 | 2 | Nordic Linen | 5015-38 | 2 | Tuscan Walnut | 7921-38 | 2 |
| Catalina | 13092-60 | 2 | Handspun Pearl | 5033-38 | 2 | Nori | 13091-60 | 2 | Twilight Zephyr | 4845-60 | 2 |
| Cement | D503-60 | 2 | Hanspun Slate | 5035-38 | 2 | North Sea | D90-60 | 2 | Wallaby | D439-60 | 2 |
| Centizo Cherry | 8239-38 | 2 | Harvest Maple | 7953-38 | 2 | Norwegian Ash | 8241-38 | 2 | Washi Crystal | 5017-38 | 2 |
| Classic Linen | 4843-38 | 2 | high Rise | 4996-38 | 2 | Oiled Soapstone | 4882-38 | 2 | Washi Pewter | 5018-38 | 2 |
| Cloud Nebula | 4830-60 | 2 | Hollyberry | D307-60 | 2 | Orange Grove | D501-60 | 2 | White | 1570-60 | 2 |
| Cloud Zephyr | 4856-60 | 2 | Huntington Mplae | 7929-38 | 2 | Organic Cotton | 4945-38 | 2 | White Carrara | 4924-38 | 2 |
| Coffee Bean | D495-60 | 2 | Indigo | D379-60 | 2 | Palisades Oak | 7987-38 | 2 | White Cascade | 5003-38 | 2 |
| Crisp Linen | 4942-38 | 2 | Invroy Birch | 8219-38 | 2 | Pampas | 4170-60 | 2 | White Nebula | 4621-60 | 2 |
| Crystal | D388-60 | 2 | Jubilee Oak | 8242-38 | 2 | Pasadena Oak | 7966-38 | 2 | White Sand | D403-60 | 2 |
| Desert Zephyr | 4841-60 | 2 | Kensington Maple | 10776-60 | 2 | Pearl Soapstone | 4886-38 | 2 | White Tigris | 4783-60 | 2 |
| Dove Grey | D92-60 | 2 | Khaki Brown | D50-60 | 2 | Pepperdust | D327-60 | 2 | Wild Cherry | 7054-60 | 2 |
| Dragon Fly | 13088-60 | 2 | Kingswood Walnut | 8218-38 | 2 | Pewter | D73-60 | 2 | Windswept Pewter | 4795-60 | 2 |
| Ebony Recon | 7997-38 | 2 | Lapis Blue | D417-60 | 2 | Pewter Brush | 4779-60 | 2 | Woolamai Brush | 4746-60 | 2 |
| Evening Tigris | 4674-60 | 2 | Limber Maple | 10734-60 | 2 | Pewter Mesh | 4878-38 | 2 | | | |
| Fashion Grey | D381-60 | 2 | Linen | D427-60 | 2 | Pinnacle Walnut | 7992-38 | 2 | | | |
| Flax Linen | 4930-38 | 2 | Loden Zephyr | 4844-60 | 2 | Platinum | D315-60 | 2 | | | |

PVC Edge Selection

Tier 2 Laminates require the additional specification of a PVC edge band. Choose from one of the following JSI standard options.

| | | | |
|-----|-----------------|-----|-----------------|
| ALB | Alabaster | MES | Mesa |
| BEL | Belair | MIN | Mineral |
| BLK | Black | MCH | Mocha |
| BRK | Brickdust | OBK | Outback |
| BBL | Bridal Blanco | PIL | Pilsner |
| CSK | Cask | PIN | Pinnacle Walnut |
| CLY | Clay | SHD | Shadow |
| DWH | Designer White | SLG | Slate Grey |
| EGR | Egret | UMB | Umber |
| FAW | Fawn | VAL | Valley |
| FLN | Flint | WLH | Walnut Heights |
| FLO | Florence Walnut | WEA | Weathered Ash |
| LOF | Loft | ZEN | Zen Grey |

Product and Finish Information

Veneer

Table Models

The Anthology suffix V or KV is used to designate veneer material.

Veneer Tops

Anthology features 1 3/8" thick veneer table top surfaces in several rim and finish options; see table top specification [page 15](#).

Top Profile

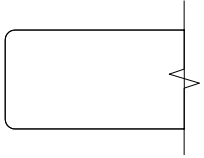

Eased (R3)

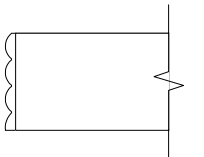

Reeded (H3)

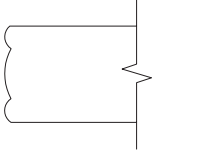

Transitional (C3)
suffix V

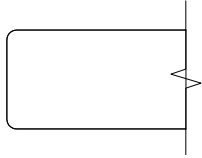

Eased (R3)

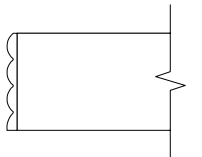

Reeded (H3)

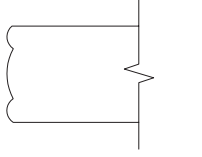

Transitional (C3)
suffix V

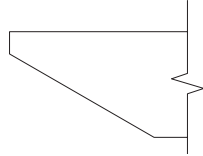

Reverse Bevel (K9)
suffix KV

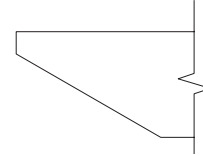

Reverse Bevel (K9)
suffix KV

ESS Essentials Veneer

| | |
|-----|-----------|
| BRK | Brickdust |
| CSK | Cask |
| CLY | Clay |
| FAW | Fawn |
| FLX | Flax |
| FLN | Flint |
| LOF | Loft |
| MES | Mesa |
| MIN | Mineral |
| MCH | Mocha |
| OBK | Outback |
| PIL | Pilsner |
| SIE | Sienna |
| TRF | Truffle |
| UMB | Umber |
| VAL | Valley |

ART Artisan Veneer

| | |
|-----|--------|
| BAR | Barrel |
| BUF | Buff |
| CND | Cinder |
| EGR | Egret |
| RAV | Raven |
| RYE | Rye |
| SAB | Sable |
| SAD | Saddle |

ESS Essentials Veneer

| | |
|-----|-----------|
| BRK | Brickdust |
| CSK | Cask |
| CLY | Clay |
| FAW | Fawn |
| FLX | Flax |
| FLN | Flint |
| LOF | Loft |
| MES | Mesa |
| MIN | Mineral |
| MCH | Mocha |
| OBK | Outback |
| PIL | Pilsner |
| SIE | Sienna |
| TRF | Truffle |
| UMB | Umber |
| VAL | Valley |

ART Artisan Veneer

| | |
|-----|--------|
| BAR | Barrel |
| BUF | Buff |
| CND | Cinder |
| EGR | Egret |
| RAV | Raven |
| RYE | Rye |
| SAB | Sable |
| SAD | Saddle |

Product and Finish Information

Bases

TFL/HPL Laminates

| | |
|-----|-----------------|
| ALB | Alabaster |
| BEL | Belair |
| BLK | Black |
| BRK | Brickdust |
| BBL | Bridal Blanco |
| CSK | Cask |
| CLY | Clay |
| DWH | Designer White |
| EGR | Egret |
| FAW | Fawn |
| FLN | Flint |
| FLO | Florence Walnut |
| LOF | Loft |
| MES | Mesa |
| MIN | Mineral |
| MCH | Mocha |
| OBK | Outback |
| PIL | Pilsner |
| PIN | Pinnacle Walnut |
| SHD | Shadow |
| SLG | Slate Grey |
| UMB | Umber |
| VAL | Valley |
| WLH | Walnut Heights |
| WEA | Weathered Ash |
| ZEN | Zen Grey |

Veneer

ESS Essentials Veneer

| | |
|-----|-----------|
| BRK | Brickdust |
| CSK | Cask |
| CLY | Clay |
| FAW | Fawn |
| FLX | Flax |
| FLN | Flint |
| LOF | Loft |
| MES | Mesa |
| MIN | Mineral |
| MCH | Mocha |
| OBK | Outback |
| PIL | Pilsner |
| SIE | Sienna |
| TRF | Truffle |
| UMB | Umber |
| VAL | Valley |

ART Artisan Veneer

| | |
|-----|--------|
| BAR | Barrel |
| BUF | Buff |
| CND | Cinder |
| EGR | Egret |
| RAV | Raven |
| RYE | Rye |
| SAB | Sable |
| SAD | Saddle |

Solid Wood

| | |
|-----|-----------------|
| BAR | Barrel |
| BRK | Brickdust |
| BUF | Buff |
| CSK | Cask |
| CND | Cinder |
| CLY | Clay |
| EGR | Egret |
| FAW | Fawn |
| FLX | Flax |
| FLN | Flint |
| FLO | Florence Walnut |
| LOF | Loft |
| MES | Mesa |
| MIN | Mineral |
| MCH | Mocha |
| OBK | Outback |
| PIL | Pilsner |
| PIN | Pinnacle Walnut |
| RAV | Raven |
| RYE | Rye |
| SAB | Sable |
| SAD | Saddle |
| SIE | Sienna |
| TRF | Truffle |
| UMB | Umber |
| VAL | Valley |
| WLH | Walnut Heights |

Product and Finish Information

Bases (continued)

Oblique Metal Bases

Metal Finish Standard

| | |
|-----|---------------|
| ABZ | Aged Bronze |
| ASL | Arctic Silver |
| BWH | Bright White |
| GLD | Gold |
| MBK | Matte Black |
| PEW | Pewter |
| SBZ | Soft Bronze |
| SNK | Soft Nickel |

Metal Finish Upcharge - add \$155

| | |
|-----|------------------|
| ANL | Antique Linen |
| BLJ | Blue Jean |
| CAP | Candy Apple |
| CAB | Cashmere Beige |
| CDU | Copper Dust |
| DST | Desert Stone |
| DUP | Dusty Petal |
| EBL | Electric Blue |
| EMC | Emerald City |
| EVP | Evergreen Pine |
| GOH | Golden Honey |
| MWH | Midnight Whisper |
| MUS | Mustard Seed |
| OLV | Olive Fog |
| POW | Porcelain White |
| SPA | Space Cadet |
| SPP | Sparkling Peach |
| SPR | Spiced Raisin |
| SMK | Stormy Sky |
| TFB | Toffee Brown |
| VMA | Vintage Mahogany |

Frame and Outline Metal Bases

Metal Finish Standard

| | |
|-----|---|
| ABZ | Aged Bronze |
| ASL | Arctic Silver |
| BWH | Bright White |
| CHR | Chrome- upcharge applies- see pricing pages |
| GLD | Gold |
| MBK | Matte Black |
| PEW | Pewter |
| SBZ | Soft Bronze |
| SNK | Soft Nickel |

Metal Finish Upcharge - add \$155

| | |
|-----|------------------|
| ANL | Antique Linen |
| BLJ | Blue Jean |
| CAP | Candy Apple |
| CAB | Cashmere Beige |
| CDU | Copper Dust |
| DST | Desert Stone |
| DUP | Dusty Petal |
| EBL | Electric Blue |
| EMC | Emerald City |
| EVP | Evergreen Pine |
| GOH | Golden Honey |
| MWH | Midnight Whisper |
| MUS | Mustard Seed |
| OLV | Olive Fog |
| POW | Porcelain White |
| SPA | Space Cadet |
| SPP | Sparkling Peach |
| SPR | Spiced Raisin |
| SMK | Stormy Sky |
| TFB | Toffee Brown |
| VMA | Vintage Mahogany |

Power and Cutout Information

Power Types



Cutout CA Node

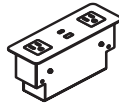

Cutout CB Electrolite

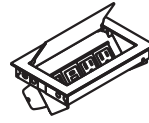

Cutout CD Ellora

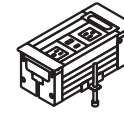

Cutout CE Vault Retractable



Cutout CF M2X Two Sided

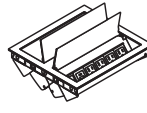

Cutout CG Ellora Double

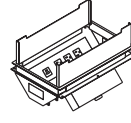

Cutout CH Oasis Two Sided

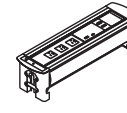

Cutout CJ Vault BTC Rotating

Anthology Power Modules offer a broad selection of performance features to support small to large power requirements including USB A+C. Models are available as single specified units, with selected models available in kits linked together with a single plug. Price list [pages 60 - 69](#) for power unit specifications.

Pre-determined cutout locations are available based on top size and base style. Cutouts are \$34 per cutout.

| | |
|---------------|-------|
| Two cutouts | \$68 |
| Three cutouts | \$102 |
| Four cutouts | \$136 |

To order: specify code associated with power module and location.
CD2M = Ellora- 2 cutouts- Mid Location

Planning location codes [see page 30](#).

Specification Overview

TABLE TOPS, BASES, AND POWER COMPONENTS ARE ORDERED SEPARATELY

SELECT TOP MATERIAL

Choose between TFL with eased pvc rim, HPL with eased or reverse bevel pvc rim, and Veneer with eased, reeded, transitional, or reverse bevel veneer edge band.

SELECT TOP SIZE AND SHAPE

Options include, rectangular, soft rectangular, arc rectangular, boat, arc boat, racetrack, and round. Sizes range from 36" –60" depth and 72" –240" width in 6" increments to accommodate various room sizes.

SELECT BASE STYLE AND FINISH

- Bevel, Bridge, and Fluted Cylinder solid wood bases.
- Conical and Racetrack HPL and Veneer bases.
- Outline TFL and Veneer bases.
- Oblique Metal powdercoat bases.
- Frame and Frame BridgeLine metal powdercoat and chrome bases.
- Racetrack and Racetrack BridgeLine HPL and Veneer bases.

For ease of specification bases are sold in kits aligned to specific top sizes. The base kit is a complete set of bases, mounting brackets, screws, along with stretcher rails and undersurface metal support as required for applicable top sizes.

SELECT THE POWER MODULES

Options for power include:

Electrolite, Ellora, Ellora Double, M2X, Node, Oasis, Vault Z23 Retractable, and Vault BTC Rotating. A broad selection of performance features support small to large power requirements including USB A+C.

Selected models are available with corded plug, hardwire, or one-, two-, three-, and four-unit kits linked together with a single plug. Kits include power units, jumpers, power infeed, and all applicable parts to simplify specification. Kits are specific to table width.

Anthology tops and bases are designed to be specified together as per the application guidelines listed in the pricing section. They are not to be used with tops and bases from other series.

Table Top Specification

PRODUCT SPECIFICATIONS

Top shapes are available in rectangular, soft rectangular, arc rectangular, boat, arc boat, racetrack, and round. Sizes range from 36" – 60" depth and 72" – 240" width in 6" increments.

TOPS ARE BALANCED CONSTRUCTION AVAILABLE IN

- TFL (thermally fused laminate) 1 1/8" thick particle board core with 3mm PVC Eased (R3) rim.
- HPL (high pressure laminate) 1 3/16" thick particle board core with 3mm PVC Eased (R3) rim.
- HPL (high pressure laminate) 1 3/16" thick MDF core with 1mm PVC Reverse Bevel (K9) rim. Underside of bevel is painted to match PVC rim.
- Veneer 1 3/16" thick particle board core with 3mm veneer edge band in Eased (R3), Reeded (H3), or Transitional (C3) rims.
- Veneer 1 3/16" thick MDF with 1mm edge band Reverse Bevel (K9). Underside of bevel is finished to match surface and edge band.
- Tops are rimmed on all sides.
- TFL and HPL tops are standard with PVC rim to match the top color.
- Veneer tops are standard with edge band stained to match top.
- HPL tops are available with an extended laminate offering (Tier 2) from Formica and Wilsonart. Customer will select the PVC edge color.
- Grain direction for TFL, HPL, and Veneer runs with the width of the top (left to right).
- Great care is taken to align multi-piece laminate woodgrain tops as closely as possible at the seams. However; due to the natural pattern variations and manufacturing tolerances, a perfect grain match cannot be guaranteed.
- See pricing pages for top sections by model.
 - 72" – 96" widths – one piece top
 - 102" – 120" widths – one- and two-piece tops
 - 126" – 192" – two-piece tops
 - 198 – 240" – 3 equal piece tops
- Multiple piece tops ship with joint connectors and biscuits to align and draw table sections together at the seams. Hardware to attach tops to bases, ship with the base or base kits.

Base Specification

BEVEL BASE KIT

Available in maple, oak, and walnut solid wood. Wood species aligns with respective finish.

1. Base is 27 7/8" high, 29" with 1 1/8" top.
2. Base kits are specific to top depth and width, and come in two-, three-, and four-base configurations. Supports top sizes 36"-60" depth and 72"-240" width.
3. Base depths are 18", 24", and 30". Individual base dimensions are 4" wide x 1 3/8" thick.
4. Metal mounting plates, with hardwood end and center rails.
5. Center bases have a 2" diameter cord pass through for routing cords base to base under the table top.
6. Veneer side stretcher rails, 3" high x 1 1/8" deep will match base finish.
7. Base includes levelers.
8. Attachment hardware for top ships with base.
9. Order cord management to floor separately.

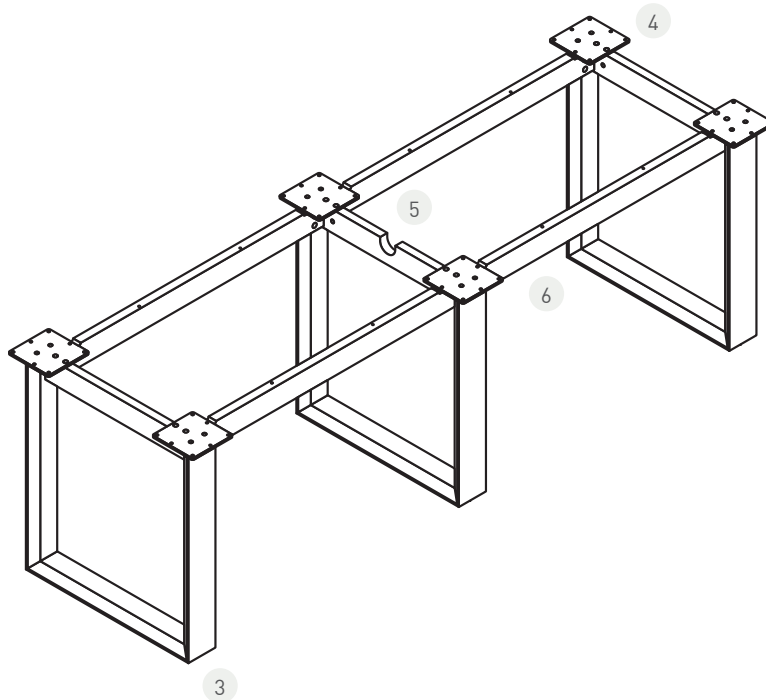

Base Specification

BRIDGE BASE KIT

Available in maple, oak, and walnut solid wood. Wood species aligns with respective finish.

1. Base is 27 7/8" high, 29" with 1 1/8" top.
2. Base kits are specific to top depth and width, and come in two-, three-, and four-base configurations. Supports top sizes 36"-60" depth and 72"-240" width.
3. Base depths are:
 - 24" at bottom, 14 3/8" at top
 - 30" at bottom, 20 3/8" at top
 - 36" at bottom, 26 3/8" at top
4. Individual base dimensions are 3" wide, 3/8" thick. Horizontal rail is 3" high x 1" thick.
5. Center bases have a 2" diameter cord pass through for routing cords base to base under the table top.
6. Veneer side stretcher rails, 3" high x 1 1/8" deep will match base finish.
7. Metal mounting plates, with hardwood end and center rails.
8. Attachment hardware for top ships with base.
9. Base includes levelers.
10. Order cord management to floor separately.

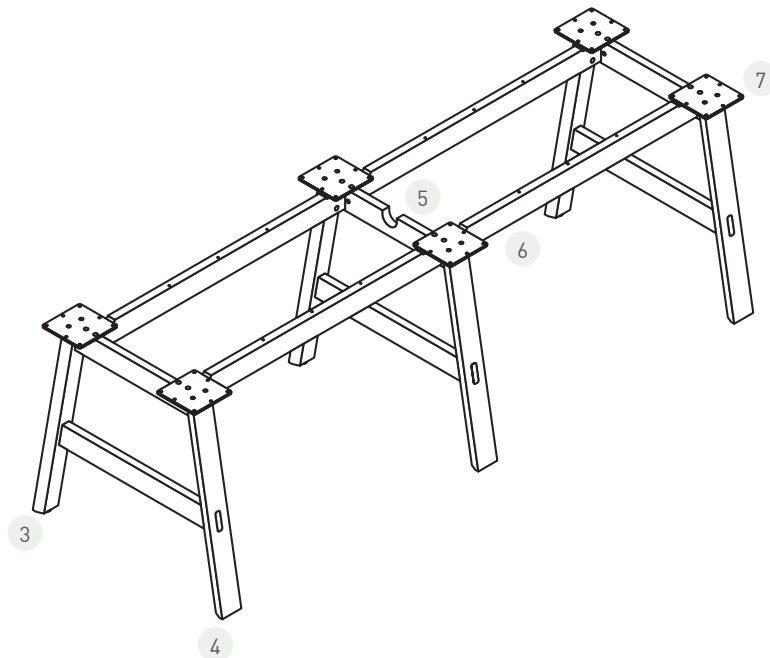

Base Specification

CONICAL SINGLE BASE & CONICAL BASE KIT

Available in HPL and Veneer surfaces. Grain runs vertical.

1. Base is 27 7/8" high, 29" with 1 1/8" top.
2. Single bases are for use with round tops from 36" -60". Available with or without access for cable management.
3. Base kits are specific to top depth and width, and come in two-, three-, and four-base configurations. Supports top sizes 42"-60" depth and 102" -240" width. Base kits come standard with a combination of access and non access doors. Access base can be in any base location to accommodate floor power.
 - 2 base kits include 1 access and 1 non access base
 - 3 base kits include 1 access and 2 non access bases
 - 4 base kits include 2 access and 2 non access bases
4. All 20" diameter bases are 20" at bottom and taper to 12" at top. Cable management opening is 6" at top and 9" at bottom.
5. All 24" diameter bases are 24" at bottom and taper to 16" at top. Cable management opening is 9" at the top and bottom.
6. All models have a cord pass through at upper side of base for routing cords base to base under the table top. Opening is 1 5/8" wide x 2 1/4" high (not visible on line art below.)
7. Quick release removable access panel.
8. The counterweight will be included and will ship with the following bases:
 - Single base for 36" -60" round tops.
 - Base kits for 42" -48" depth and 102" -240" width tops.
9. Black particle board mounting pad with a attachment hardware for top ships with base.
10. Base includes levelers.
11. Selected models ship with metal support that runs with width of base where required.

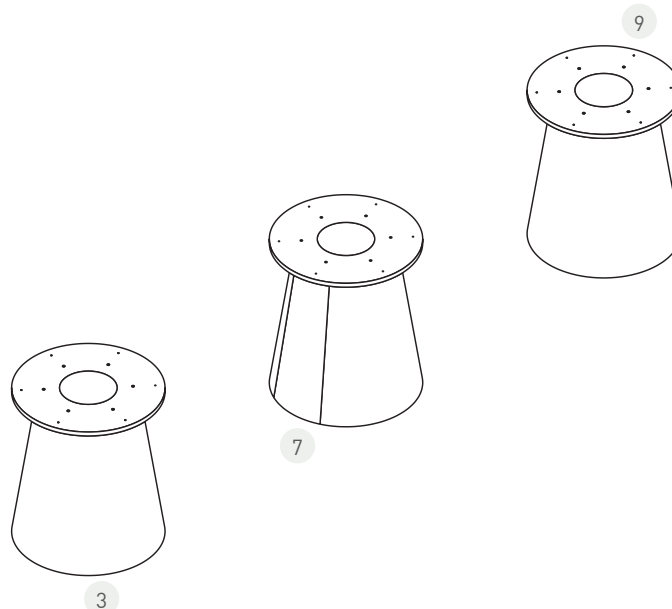

Base Specification

FLUTED CYLINDER SINGLE BASE & FLUTED CYLINDER BASE KIT

Available in maple, oak, and walnut fluted solid wood. Wood species will align to respective finish. Grain runs vertical.

1. Base is 27 7/8" high, 29" with 1 1/8" top.
2. Single bases are for use with round tops from 36" -60". Available with or without access for cable management.
3. Base kits are specific to top depth and width, and come in two-, three-, and four-base configurations. Supports top sizes 42"-60" depth and 102" -240" width. Base kits come standard with a combination of access and non access doors. Access base can be in any base location to accommodate floor power.
 - 2 base kits include 1 access and 1 non access base
 - 3 base kits include 1 access and 2 non access bases
 - 4 base kits include 2 access and 2 non access bases
4. All 18 model bases are 19 1/8" diameter with fluted profile. Cable management opening is 11 1/2" diameter at top 7" diameter at bottom.
5. All 24 model bases are 24 5/8" diameter with fluted profile. Cable management opening is 15" diameter at the top and 9" diameter at bottom.
6. All models have a cord pass through at upper side of base for routing cords base to base under the table top. Opening is 1 5/8" wide x 2 1/4" height.
7. Access base has a 10" x 10" square hinged door.
8. The counterweight will be included and will ship with the following bases:
 - Single base for 36" -60" round tops.
 - Base kits for 42" -48" depth and 102" -240" width tops.
9. Black particle board mounting pad with a attachment hardware for top ships with base.
10. Base includes levelers.
11. Selected models ship with metal support that runs with width of base where required.

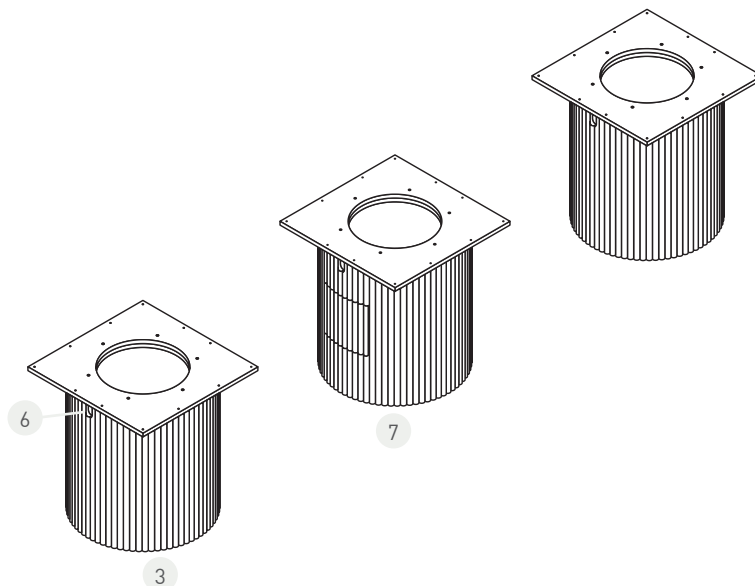

Base Specification

FRAME BASE KIT

Available in metal powdercoat paint and chrome finishes.

1. Base is 27 7/8" high, 29" with 1 1/8" top.
2. Base kits are specific to top depth and width, and come in two-, three-, and four-base configurations. Supports top sizes 36"-60" depth and 72"-240" width.
3. The bottom and sides of each base are 14 gauge, 2" x 1" rectangle tube.
4. Bases are tapered in design.
 - 18" depth bottom, tapers to 22 7/8" at top.
 - 24" depth bottom, tapers to 28 7/8" at top.
 - 30" depth bottom, tapers to 34 7/8" at top.
5. Metal mounting plates, and end rails are painted to match base.
6. Side stretcher rails, 3" high x 1 1/8" deep Black TFL.
7. Base includes levelers.
8. Attachment hardware for top ships with base.
9. Magnetic Metal Wire Manager sold separately.

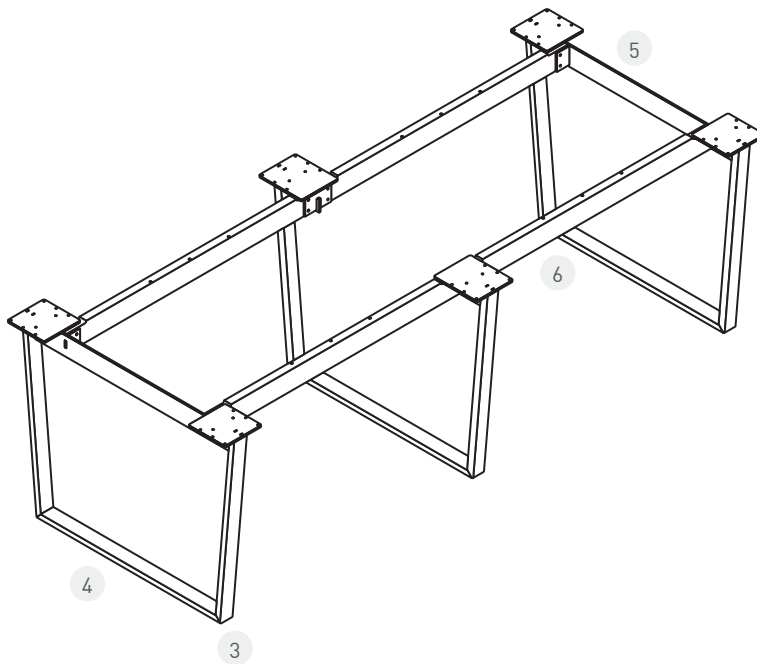

Base Specification

FRAME BRIDGELINE BASE KIT

Available in metal powdercoat paint and chrome finishes.

1. Base is 27 7/8" high, 29" with 1 1/8" top.
2. Base kits are specific to top depth and width, and come in two-base configurations. Supports top sizes 48", 54", 60" depth and 120" -192" width.
3. Bottom and sides of each base are 14 gauge, 2" x 1" rectangle tube.
4. Bases are tapered in design.
 - 24" depth bottom, tapers to 28 7/8" at top.
 - 30" depth bottom, tapers to 34 7/8" at top.
5. Metal mounting plates and center support structure are black. End rails are painted to match the base.
6. Two metal side beams are black 14-gauge tube, 3" high x 1" in.
7. Base includes levelers.
8. Attachment hardware for top ships with base.
9. Magnetic metal wire manager sold separately.

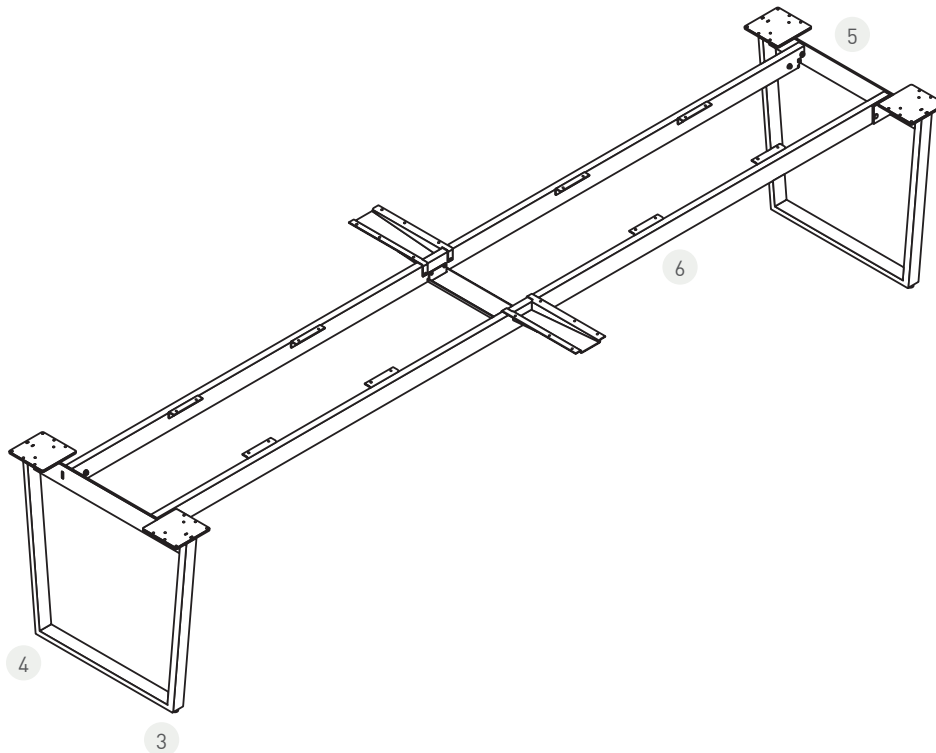

Base Specification

OBLIQUE BASE KIT

Available in metal standard and additional powdercoat finishes.

1. Base is 27 7/8" high, 29" with 1 1/8" top.
2. Base kits are specific to top depth and width, and come in two-, three-, and four-base configurations. Supports top sizes 36"-60" depth and 72"-240" width.
3. Legs are 14 gauge, 3" round tube.
4. Base depths are:
 - 24" models are 27" at bottom, 17 3/8" at top.
 - 30" models are 33" at bottom, 23 3/8" at top.
 - 36" models are 39" at bottom, 29 3/8" at top.
5. Center bases allow cord pass through for routing cords base to base under the table top.
6. Metal mounting plates, and end rails are painted to match the base.
7. Side stretcher rails, 3" high x 1 1/8" deep Black TFL.
8. Base includes levelers.
9. Attachment hardware for top ships with base

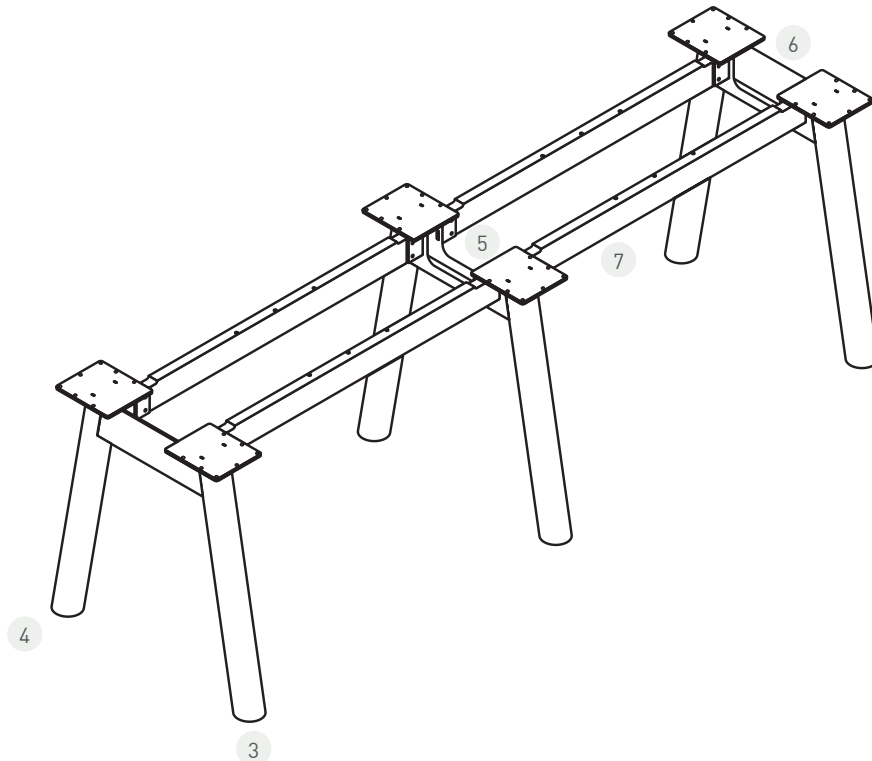

Base Specification

OUTLINE BASE KIT

Available in TFL and Veneer surfaces with powdercoat or chrome metal accent trim. Grain runs vertical.

1. Base is 27 7/8" high, 29" with 1 1/8" top.
2. Base kits are specific to top depth and width, and come in two-, three-, and four-base configurations. Supports top sizes 36"-60" depth and 72"-240" width.
3. Individual base depths are 18", 24", and 30. Base width is 1 1/2".
4. Base design features a 1 1/8" thick panel with a 3/4" x 1 1/2", 14-gauge metal accent trim at sides and bottom.
5. Metal mounting plates.
6. Side stretcher rails, 3" high x 1 1/8" deep and match base finish.
7. Center bases have a 1 5/8" wide x 2" high cord pass through for routing cords base to base under the table top.
8. Base includes levelers.
9. Attachment hardware for top ships with base
10. Order cord management to floor separately.

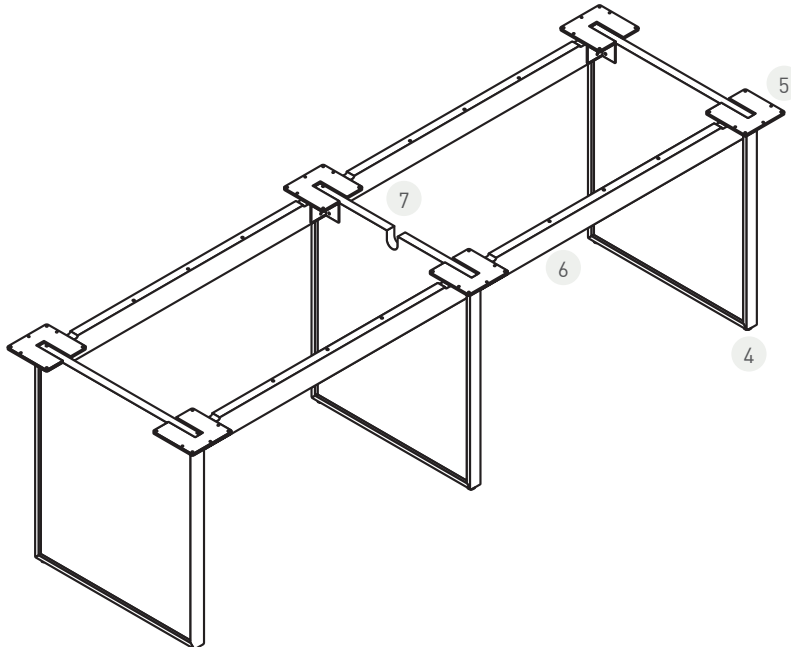

Base Specification

RACETRACK BASE KIT

Available in HPL and Veneer surfaces. Grain runs vertical.

1. Base is 27 7/8" high, 29" with 1 1/8" top.
2. Base kits are specific to top depth and width, and come in two-, three-, and four-base configurations. Supports top sizes 36"-60" depth and 72"-240" width.
3. Individual base depths are 18", 24", and 30". Base width is 6".
4. Interior clearances for cable management are as follows:
 - Top opening is 3 3/8" wide, bottom opening is 2 1/2" wide.
 - Top and bottom depth opening is:
 - 9 1/2" for 18" base
 - 15 1/2" for 24" base
 - 21 1/2" for 30" base
5. All bases in the kit feature a removable access panel on inside of each base. The center base can have removable access positioned in either direction.
6. Side stretcher rails, 3" high x 1 1/8" deep and match base finish.
7. Attachment hardware for top ships with base
8. Base includes levelers.

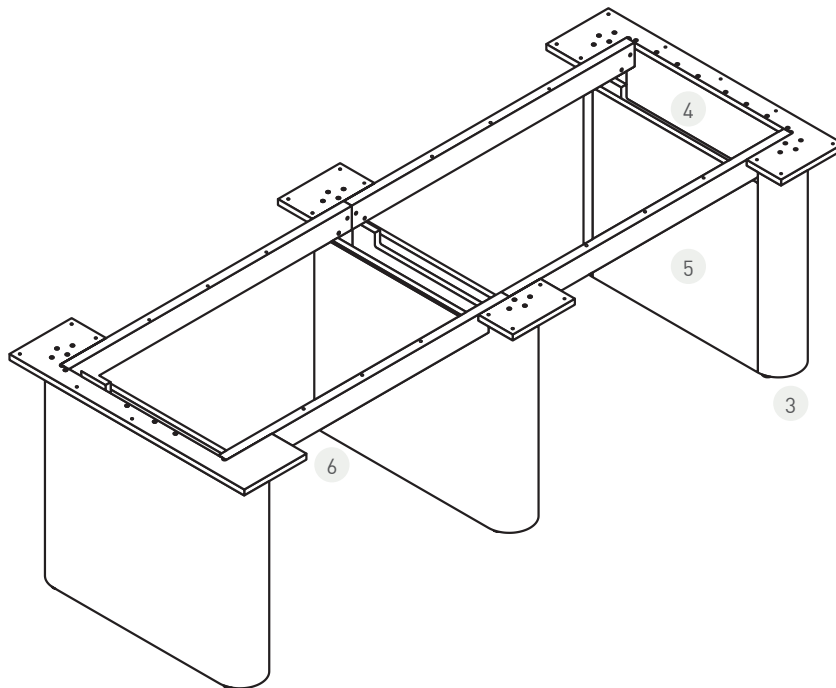

Base Specification

RACETRACK BRIDGELINE BASE KIT

Available in HPL and Veneer surfaces. Grain runs vertical.

1. BridgeLine Base Kits feature a patent-pending 2 base support structure.
2. Base is 27 7/8" high, 29" with 1 1/8" top.
3. Base kits are specific to top depth and width, and come in 2-base configurations. Supports top sizes 48", 54", 60" depth and 120" –192" width.
4. Individual base depths are 24" and 30". Base width is 6".
5. Interior clearances for cable management are as follows:
 - Top opening is 3 3/8" wide, bottom opening is 2 1/2" wide.
 - Top and bottom depth opening is:
 - 15 1/2" for 24" base
 - 21 1/2" for 30" base
6. Each base in the kit features a removable access door on inside of the base.
7. Mounting pads: metal center support structure and rails are black.
8. Two metal side beams are black 14-gauge tube, 3" high x 1".
9. Base includes levelers.
10. Attachment hardware for top ships with base.

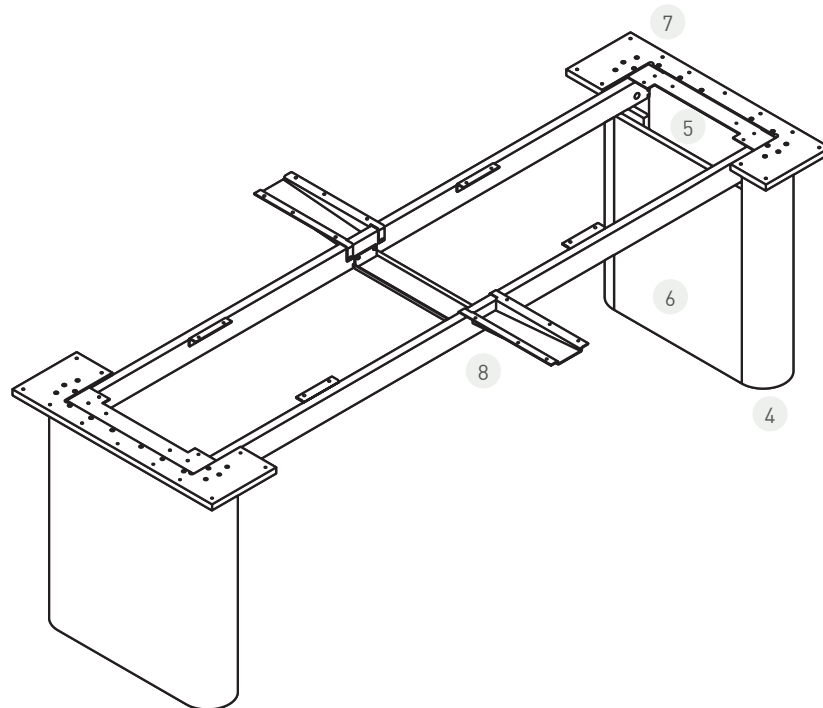

Seating Capacity

RECOMMENDED SEATING CAPACITY

Applies to rectangular, soft rectangular, arc rectangular, boat, arc boat, racetrack, and round.

| Top Width | Depth | | | | |
|-----------|-------|-----|-----|-----|-----|
| | 36" | 42" | 48" | 54" | 60" |
| 36 | 3 | | | | |
| 42 | | 4 | | | |
| 48 | | | 4 | | |
| 54 | | | | 6 | |
| 60 | | | | | 8 |
| 72 - 90 | 6 | 6 | 6 | | |
| 96 | 8 | 8 | 8 | | |
| 102 - 114 | | 8 | 8 | | |
| 120 | | 8 | 8 | 8 | 10 |
| 126 - 132 | | | 8 | 8 | 10 |
| 138 - 144 | | | 10 | 10 | 10 |
| 150 - 162 | | | 10 | 10 | 12 |
| 168 - 174 | | | 12 | 12 | 12 |
| 180 - 186 | | | 12 | 12 | 14 |
| 192 - 216 | | | 14 | 14 | 16 |
| 222 | | | 16 | 16 | 16 |
| 228 - 240 | | | 16 | 16 | 18 |

Base Placement Dimensions

BASE LOCATIONS

Base Type: Bevel, Bridge, Outline, Oblique, Frame, Frame BridgeLine, Racetrack, Racetrack BridgeLine

Applies to all top shapes and depths.

1—, Left and Right End base dimension are from the outside end of top to the outside end of base.

2—, 3—, and 4— base dimensions are to the center of the base.

| Top Width | Base Quantity | 1 Left and Right to Outside End of Base | 2 Center of Center Base | 3 Center of Mid Base | 4 Center of Mid Base |
|-----------|---------------|---|-------------------------|----------------------|----------------------|
| 72 | 2 | 12 | | | |
| 78 | 2 | 12 | | | |
| 84 | 2 | 15 | | | |
| 90 | 2 | 15 | | | |
| 96 | 2 | 18 | | | |
| 102 | 2 | 18 | | | |
| 108 | 2 | 18 | | | |
| 114 | 2 | 18 | | | |
| 120 | 3 | 18 | 60 | | |
| 126 | 3 | 18 | 63 | | |
| 132 | 3 | 18 | 66 | | |
| 138 | 3 | 18 | 69 | | |
| 144 | 3 | 18 | 72 | | |
| 150 | 3 | 18 | 75 | | |
| 156 | 3 | 18 | 78 | | |
| 162 | 3 | 18 | 81 | | |
| 168 | 3 | 18 | 84 | | |
| 174 | 3 | 18 | 87 | | |
| 180 | 3 | 18 | 90 | | |
| 186 | 3 | 18 | 93 | | |
| 192 | 3 | 18 | 96 | | |
| 198 | 4 | 18 | | 66 | 132 |
| 204 | 4 | 18 | | 68 | 136 |
| 210 | 4 | 18 | | 70 | 140 |
| 216 | 4 | 18 | | 72 | 144 |
| 222 | 4 | 18 | | 74 | 148 |
| 228 | 4 | 18 | | 76 | 152 |
| 234 | 4 | 18 | | 78 | 146 |
| 240 | 4 | 18 | | 80 | 160 |

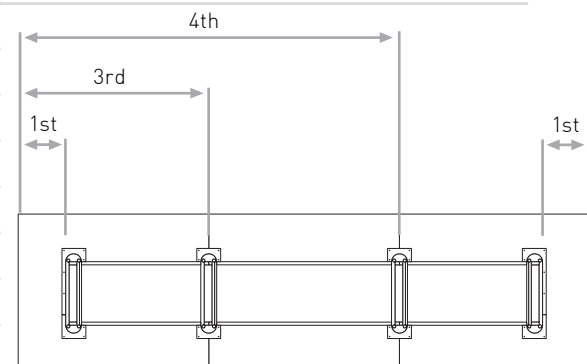
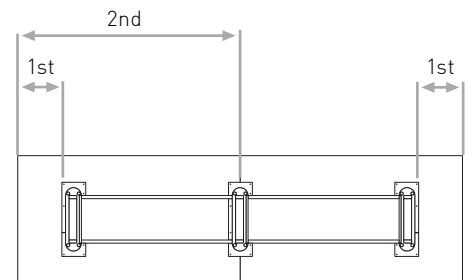
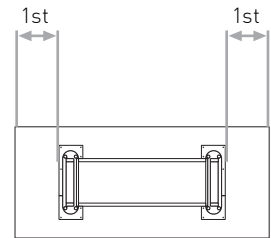

Base Placement Dimensions

BASE LOCATIONS

Base Type: Conical, Fluted

Applies to all top shapes and depths.

1—, Left and Right End base dimension are from the outside end of top to the center of base.

2—, 3—, and 4— base dimensions are to the center of the base.

| Top Width | Base Quantity | 1 Left and Right to Center End of Base | 2 Center of Center Base | 3 Center of Mid Base | 4 Center of Mid Base |
|-----------|---------------|--|-------------------------|----------------------|----------------------|
| 102 | 2 | 27 | 51 | | |
| 108 | 2 | 27 | 54 | | |
| 114 | 2 | 27 | 57 | | |
| 120 | 2 | 27 | 60 | | |
| 126 | 2 | 27 | 63 | | |
| 132 | 2 | 27 | 66 | | |
| 138 | 2 | 27 | 69 | | |
| 144 | 2 | 27 | 72 | | |
| 150 | 3 | 27 | 75 | | |
| 156 | 3 | 27 | 78 | | |
| 162 | 3 | 27 | 81 | | |
| 168 | 3 | 27 | 84 | | |
| 174 | 3 | 27 | 87 | | |
| 180 | 3 | 27 | 90 | | |
| 186 | 3 | 27 | 93 | | |
| 192 | 3 | 27 | 96 | | |
| 198 | 4 | 27 | | 75 | 123 |
| 204 | 4 | 27 | | 77 | 127 |
| 210 | 4 | 27 | | 79 | 131 |
| 216 | 4 | 27 | | 81 | 135 |
| 222 | 4 | 27 | | 83 | 139 |
| 228 | 4 | 27 | | 85 | 143 |
| 234 | 4 | 27 | | 87 | 147 |
| 240 | 4 | 27 | | 89 | 151 |

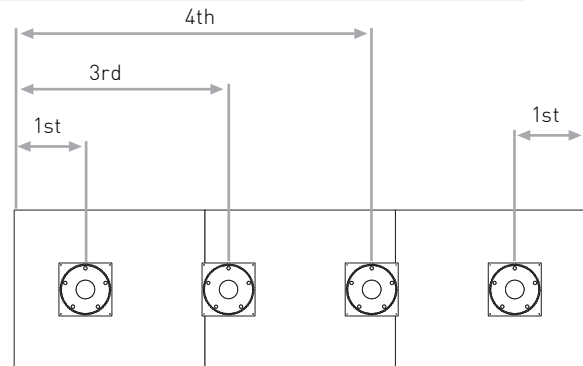
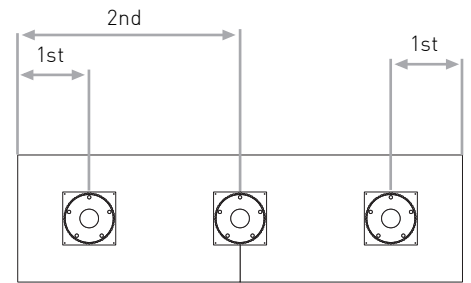
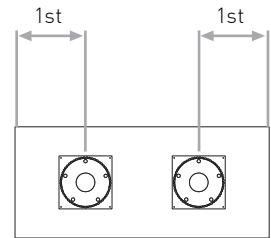

Table Top Power Overview

Anthology Power Modules offer a broad selection of performance features to support small to large power requirements including USB A+C. Models are available as single specified units. Selected models are available as modular component system kits with a single plug.

Power modules can be integrated into table tops to provide convenient electrical access for devices. There are two main ways to connect them to the building's power:

DIRECT PLUG-IN:

The power module can be connected directly to a floor monument. There must be one power outlet per single corded unit. Dual corded modules require two outlets per unit. This method requires several floor outlets to power multiple units.

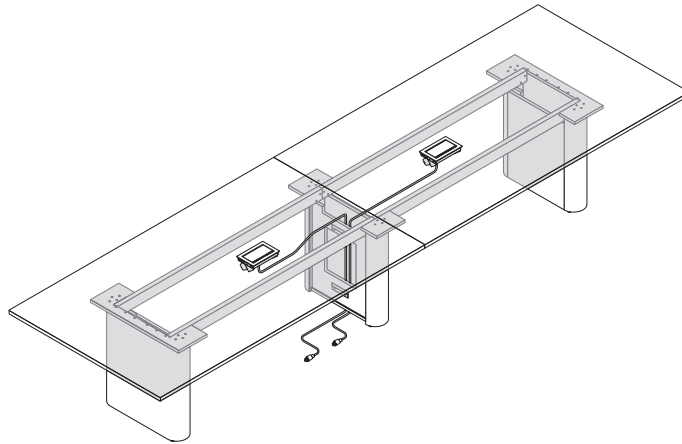

SINGLE PLUG-IN MODULAR COMPONENT SYSTEM:

Several power modules are linked with a single-circuit power system. Multiple power unit kits are linked together and connect to a floor monument with a single connection. Linking systems reduces the need for multiple floor outlets and simplify installation.

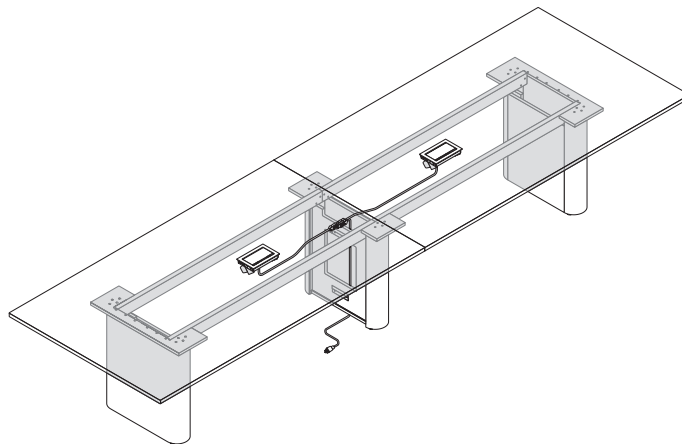

Power Types & Top Cutout Locations

PRE-DETERMINED CUTOUT LOCATIONS ARE AVAILABLE BASED ON TOP SIZE AND BASE STYLE. REFERENCE PAGES 27 -39 FOR CUTOUT LOCATION BY TOP SIZE AND BASE STYLE.

POWER TYPES



Cutout CA Node



Cutout CB Electrolite



Cutout CD Ellora

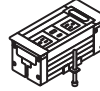

Cutout CE Vault Retractable Z23



Cutout CF M2X

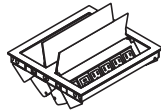

Cutout CG Ellora Double

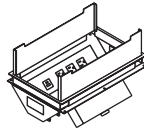

Cutout CH Oasis Two Sided

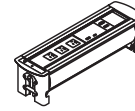

Cutout CJ Vault BTC Rotating

LOCATION CODES

| One Cutout Center | Two Cutouts Ends (over bases) | Two Cutouts Mid (between bases) | Three Cutouts Center + Ends | Three Cutouts Center + Mid | Four Cutouts Mid + Ends |
|-------------------|-------------------------------|---------------------------------|-----------------------------|----------------------------|-------------------------|
| CA1C | N/A | N/A | N/A | N/A | N/A |
| CB1C | CB2E | CB2M | CB3CE | CB3CM | CB4ME |
| CD1C | CD2E | CD2M | CD3CE | CD3CM | CD4ME |
| CE1C | CE2E | CE2M | CE3CE | CE3CM | CE4ME |
| CF1C | CF2E | CF2M | CF3CE | CF3CM | N/A |
| CG1C | CG2E | CG2M | CG3CE | CG3CM | N/A |
| CH1C | N/A | CH2M | CH3CE | CH3CM | N/A |
| CJ1C | CJ2E | CJ2M | CJ3CE | CJ3CM | N/A |

QUANTITY OF UNITS TO ORDER, FOR SINGLE UNITS OR ORDER ONE KIT BASED ON NUMBER OF CUTOUTS.

| 1 | 2 | 2 | 3 | 3 | 4 |
|---|---|---|---|---|---|
| | | | | | |
| | | | | | |
| | | | | | |
| | | | | | |

Cutout Location Guide: Grommet Dimension Center

CENTER POWER LOCATIONS FOR ALL TOP DEPTHS AND POWER CUTOUT TYPE.

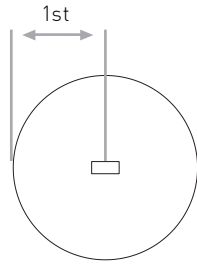

| Top Diameter | Center of 1st Power Unit |
|--------------|--------------------------|
| 36 | 18 |
| 42 | 21 |
| 48 | 24 |
| 54 | 27 |
| 60 | 30 |

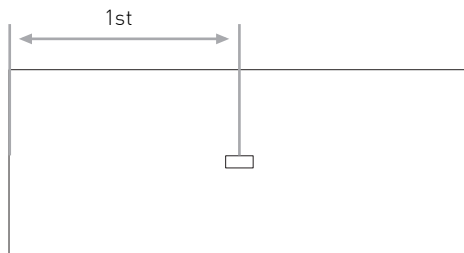

| Top Width | Center of 1st Power Unit |
|-----------|--------------------------|
| 72 | 36 |
| 78 | 39 |
| 84 | 42 |
| 90 | 45 |
| 96 | 48 |
| 102 | 51 |
| 108 | 54 |
| 114 | 57 |
| 120 | 60 |

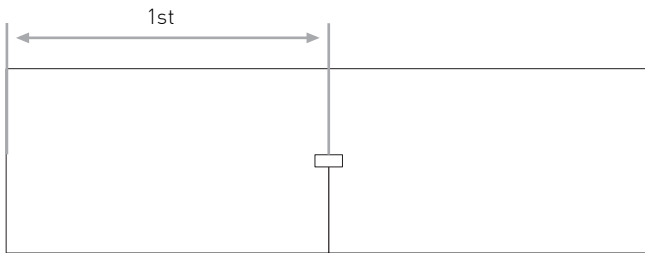

| | |
|-----|----|
| 126 | 63 |
| 132 | 66 |
| 138 | 69 |
| 144 | 72 |
| 150 | 75 |
| 156 | 78 |
| 162 | 81 |
| 168 | 84 |
| 174 | 87 |
| 180 | 90 |
| 186 | 93 |
| 192 | 96 |

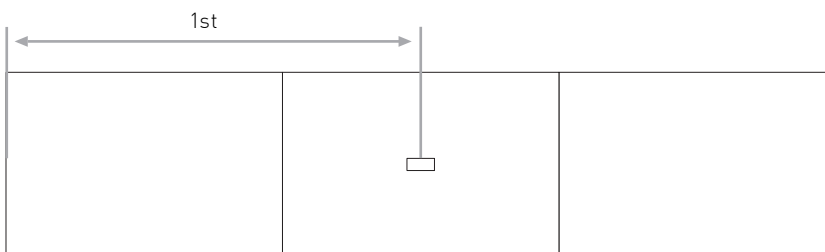

| | |
|-----|-----|
| 198 | 99 |
| 204 | 102 |
| 210 | 105 |
| 216 | 108 |
| 222 | 111 |
| 228 | 114 |
| 234 | 117 |
| 240 | 120 |

Cutout Location Guide: Grommet Dimension Ends

END POWER LOCATIONS FOR ALL TOP DEPTHS AND POWER CUTOUT TYPE.

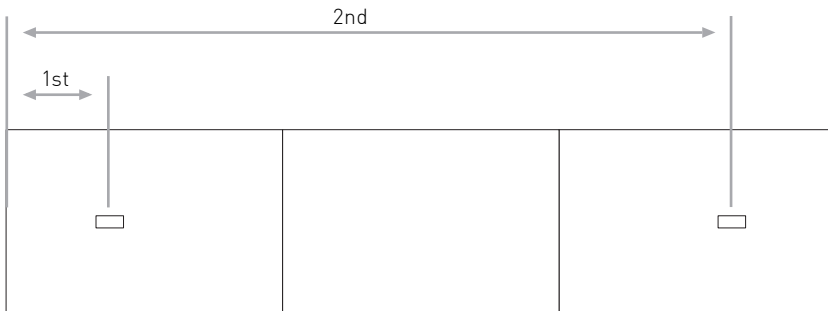
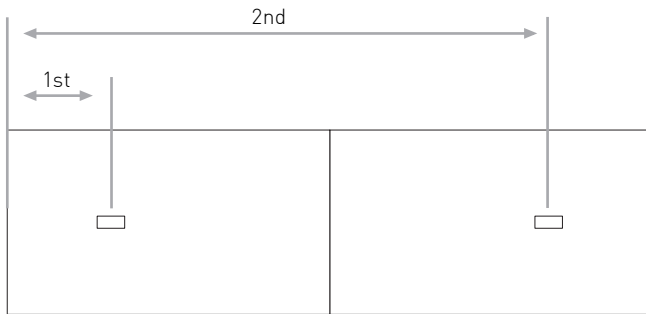
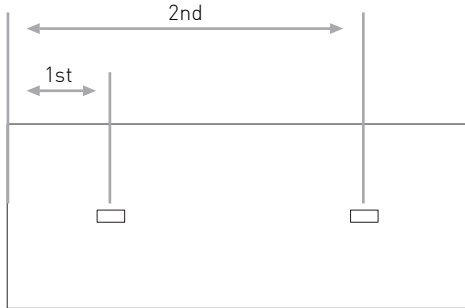

| Top Width | Center of 1st Power Unit | Center of 2nd Power Unit |
|-----------|--------------------------|--------------------------|
| 72 | 21 | 51 |
| 78 | 21 | 57 |
| 84 | 24 | 60 |
| 90 | 24 | 66 |
| 96 | 27 | 69 |
| 102 | 27 | 75 |
| 108 | 27 | 81 |
| 114 | 27 | 87 |
| 120 | 27 | 93 |
| 126 | 27 | 99 |
| 132 | 27 | 105 |
| 138 | 27 | 111 |
| 144 | 27 | 117 |
| 150 | 27 | 123 |
| 156 | 27 | 129 |
| 162 | 27 | 135 |
| 168 | 27 | 141 |
| 174 | 27 | 147 |
| 180 | 27 | 153 |
| 186 | 27 | 159 |
| 192 | 27 | 165 |
| 198 | 27 | 171 |
| 204 | 27 | 177 |
| 210 | 27 | 183 |
| 216 | 27 | 189 |
| 222 | 27 | 195 |
| 228 | 27 | 201 |
| 234 | 27 | 207 |
| 240 | 27 | 213 |

Cutout Location Guide: Grommet Dimension Center & Ends

CENTER AND END POWER LOCATIONS FOR ALL TOP DEPTHS AND POWER CUTOUT TYPE.

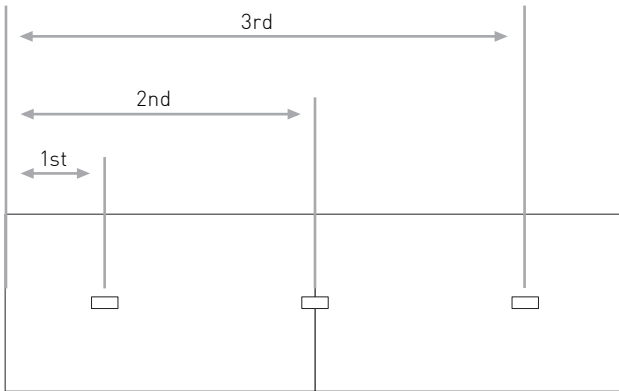

| Top Width | Center of 1st Power Unit | Center of 2nd Power Unit | Center of 3rd Power Unit |
|-----------|--------------------------|--------------------------|--------------------------|
| 102 | 27 | 51 | 75 |
| 108 | 27 | 54 | 81 |
| 114 | 27 | 57 | 87 |
| 120 | 27 | 60 | 93 |
| 126 | 27 | 63 | 99 |
| 132 | 27 | 66 | 105 |
| 138 | 27 | 69 | 111 |
| 144 | 27 | 72 | 117 |
| 150 | 27 | 75 | 123 |
| 156 | 27 | 78 | 129 |
| 162 | 27 | 81 | 135 |
| 168 | 27 | 84 | 141 |
| 174 | 27 | 87 | 147 |
| 180 | 27 | 90 | 153 |
| 186 | 27 | 93 | 159 |
| 192 | 27 | 96 | 165 |
| 198 | 27 | 99 | 171 |
| 204 | 27 | 102 | 177 |
| 210 | 27 | 105 | 183 |
| 216 | 27 | 108 | 189 |
| 222 | 27 | 111 | 195 |
| 228 | 27 | 114 | 201 |
| 234 | 27 | 117 | 207 |
| 240 | 27 | 120 | 213 |

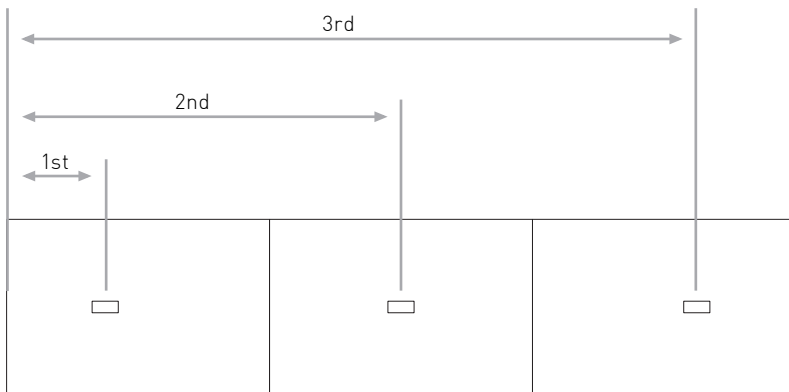

Cutout Location Guide: Grommet Dimension Mid

MID POWER LOCATIONS FOR ALL TOP DEPTHS AND POWER CUTOUT TYPE.

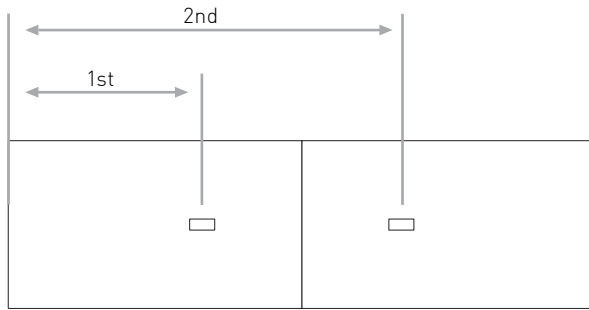

| Top Width | Center of 1st Power Unit | Center of 2nd Power Unit |
|-----------|--------------------------|--------------------------|
| 120 | 43.5 | 76.5 |
| 126 | 45 | 81 |
| 132 | 46.5 | 85.5 |
| 138 | 48 | 90 |
| 144 | 49.5 | 94.5 |
| 150 | 51 | 99 |
| 156 | 52.5 | 103.5 |
| 162 | 54 | 108 |
| 168 | 55.5 | 112.5 |
| 174 | 57 | 117 |
| 180 | 58.5 | 121.5 |
| 186 | 60 | 126 |
| 192 | 61.5 | 130.5 |
| 198 | 63 | 135 |
| 204 | 64.5 | 140 |
| 210 | 66 | 145 |
| 216 | 67.5 | 150 |
| 222 | 69 | 155 |
| 228 | 70.5 | 160 |
| 234 | 72 | 165 |
| 240 | 73.5 | 170 |

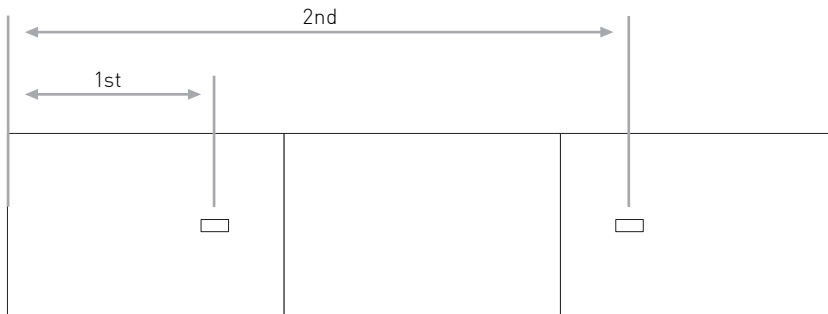

Cutout Location Guide: Grommet Dimension Center & Mid / Mid & End

CENTER & MID POWER LOCATIONS FOR ALL TOP DEPTHS AND POWER CUTOUT TYPE.

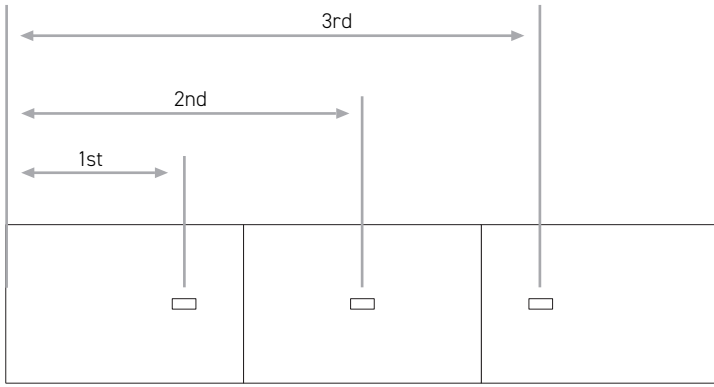

| Top Width | Center of 1st Power Unit | Center of 2nd Power Unit | Center of 3rd Power Unit |
|-----------|--------------------------|--------------------------|--------------------------|
| 198 | 51 | 99 | 147 |
| 204 | 52 | 102 | 152 |
| 210 | 53 | 105 | 157 |
| 216 | 54 | 108 | 162 |
| 222 | 55 | 111 | 167 |
| 228 | 56 | 114 | 172 |
| 234 | 57 | 117 | 177 |
| 240 | 58 | 120 | 182 |

MID & END POWER LOCATIONS FOR ALL TOP DEPTHS AND POWER CUTOUT TYPE.

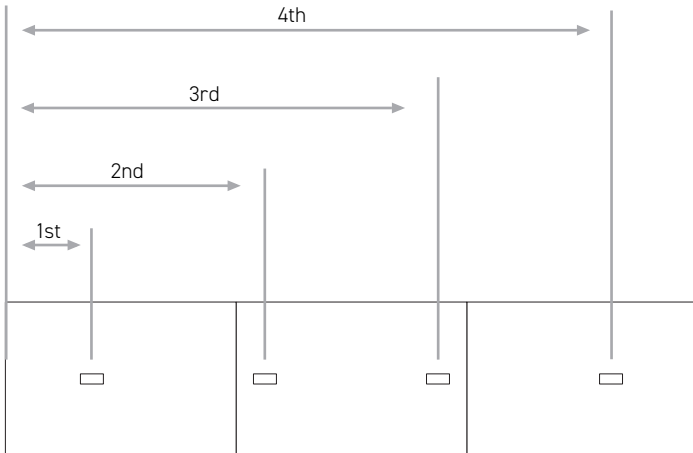

| Top Width | Center of 1st Power Unit | Center of 2nd Power Unit | Center of 3rd Power Unit | Center of 4th Power Unit |
|-----------|--------------------------|--------------------------|--------------------------|--------------------------|
| 198 | 27 | 75 | 123 | 171 |
| 204 | 27 | 77 | 127 | 177 |
| 210 | 27 | 79 | 131 | 183 |
| 216 | 27 | 81 | 135 | 189 |
| 222 | 27 | 83 | 139 | 195 |
| 228 | 27 | 85 | 143 | 201 |
| 234 | 27 | 87 | 147 | 207 |
| 240 | 27 | 89 | 151 | 213 |

Table Top Power Options

BASE TYPE: BEVEL BASE KIT, BRIDGE BASE KIT, OUTLINE BASE KIT

Top Shape: Rectangular, Soft Rectangular, Racetrack, Boat, Arc Boat, Arc Rectangular

Top Depth: 48", 54", 60"

Top Depth: 36", 42" Bevel and Outline Base Kit

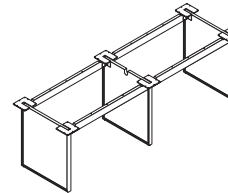
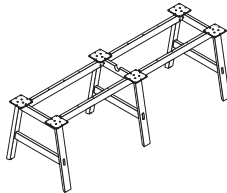
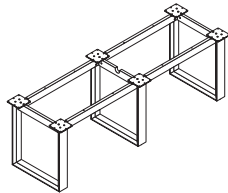

| Top Width | Cutout CB Electrolite | Cutout CD Ellora | Cutout CE Vault Z23 Retractable | Cutout CF M2X | Cutout CG Ellora Double | Cutout CH Oasis | Cutout CJ Vault BTC Rotating |
|-------------|---|-----------------------|------------------------------------|-----------------------|----------------------------|-----------------------|---------------------------------|
| 72" - 78" | CB1C | CD1C | CE1C | CF1C | N/A | N/A | N/A |
| 84" - 96" | CB1C CB2E | CD1C | CE1C CE2E | CF1C | N/A | N/A | N/A |
| 102" | CB1C CB2E | CD1C | CE1C CE2E CE3CE | CF1C | CG1C | CH1C | CJ1C |
| 108" - 114" | CB1C CB2E CB3CE | CD1C | CE1C CE2E CE3CE | CF1C | CG1C | CH1C | CJ1C |
| 120" - 174" | CB2E CB2M | CD2M | CE2M | CF2M | CG2M | CH2M | CJ2M |
| 180" - 192" | CB2E CB2M | CD2M | N/A | CF2M | CG2M | CH2M | CJ2M |
| 198" - 234" | CB1C CB2E CB2M CB3CE CB3CM CB4ME | CG1C CG2M CG3CM | CE1C CE3CM CE4ME | CF1C CF2M CF3CM | CG1C CG2M CG3CM | CH1C CH2M CH3CM | CJ1C CJ2M CJ3CM |
| 240" | CB1C CB2E CB2M CB3CE CB3CM CB4ME | CG1C CG2M CG3CM | CE1C | CF1C CF2M CF3CM | CG1C CG2M CG3CM | CH1C CH2M CH3CM | CJ1C CJ2M CJ3CM |

Table Top Power Options

BASE TYPE: BRIDGE BASE KIT

Top Shape: Rectangular, Soft Rectangular, Racetrack, Boat, Arc Boat, Arc Rectangular

Top Depth: 36", 42"

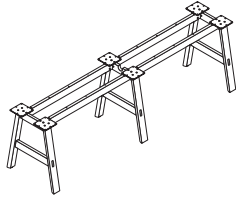

| Top Width | Cutout CB Electrolite | Cutout CD Ellora | Cutout CE Vault Z23 Retractable | Cutout CJ Vault BTC Rotating |
|------------|--------------------------|---------------------|------------------------------------|---------------------------------|
| 72" -78" | CB1C | CD1C | CE1C | N/A |
| 84" -96" | CB1C CB2E | CD1C | CE1C CE2E | N/A |
| 102" -114" | CB1C CB2E | CD1C | CE1C CE2E CE3CE | CJ1C |
| 120" | CB2E CB2M | CD2M | CE2M | CJ2M |

Table Top Power Options

BASE TYPE: CONICAL

Top Shape: Round

Top Size: 36", 42", 48", 54", 60"



| Top Width | Cutout CA Node |
|-----------|--|
| |  |
| 36" -60" | CA1C |

Table Top Power Options

BASE TYPE: CONICAL BASE KIT

Top Shape: Rectangular, Soft Rectangular, Racetrack, Boat, Arc Boat

Top Size: 42", 48"

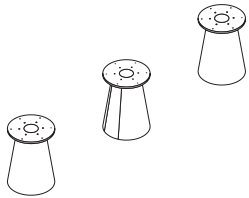

| Top Width | Cutout CB Electrolite | Cutout CD Ellora | Cutout CE Vault Z23 Retract- ah | Cutout CF M2X | Cutout CG Ellora Double | Cutout CH Oasis | Cutout CJ Vault BTC Rotating |
|------------|--------------------------|---------------------|---------------------------------------|------------------|----------------------------|--------------------|---------------------------------|
| 102" -144" | CB1C | CD1C | CE1C | CF1C | CG1C | CH1C | CJ1C |
| 150" -174" | CB2M | CD2M | CE2M | CF2M | CG2M | CH2M | CJ2M |
| 180" -192" | CB2M | CD2M | N/A | CF2M | CG2M | CH2M | CJ2M |
| 198" -234" | CB1C | CD1C | CE1C | CF1C | CG1C | CH1C | CJ1C |
| | CB2M | CD2M | CE3CM | CF2M | CG2M | CH2M | CJ2M |
| | CB3CM | CD3CM | | CF3CM | CG3CM | CH3CM | CJ3CM |
| 240" | CB1C | CD1C | CE1C | CF1C | CG1C | CH1C | CJ1C |
| | CB2M | CD2M | | CF2M | CG2M | CH2M | CJ2M |
| | CB3CM | CD3CM | | CF3CM | CG3CM | CH3CM | CJ3CM |

Table Top Power Options

BASE TYPE: CONICAL BASE KIT

Top Shape: Rectangular, Soft Rectangular, Racetrack, Boat, Arc Boat, Arc Rectangular

Top Size: 54", 60"

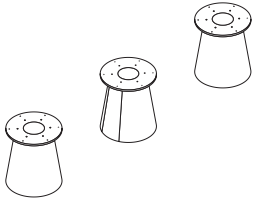

| Top Width | Cutout CB Electrolite | Cutout CD Ellora | Cutout CE Vault Z23 Retractable | Cutout CF M2X | Cutout CG Ellora Double | Cutout CH Oasis | Cutout CJ Vault BTC Rotating |
|------------|--------------------------|---------------------|------------------------------------|------------------|----------------------------|--------------------|---------------------------------|
| 120" -144" | CB1C | CD1C | CE1C | CF1C | CG1C | CH1C | CJ1C |
| 150" -174" | CB2M | CD2M | CE2M | CF2M | CG2M | CH2M | CJ2M |
| 180" -192" | CB2M | CD2M | N/A | CF2M | CG2M | CH2M | CJ2M |
| 198" -234" | CB1C | CD1C | CE1C | CF1C | CG1C | CH1C | CJ1C |
| | CB2M | CD2M | CE3CM | CF2M | CG2M | CH2M | CJ2M |
| | CB3CM | CD3CM | | CF3CM | CG3CM | CH3CM | CJ3CM |
| 240" | CB1C | CD1C | | CF1C | CG1C | CH1C | CJ1C |
| | CB2M | CD2M | CE1C | CF2M | CG2M | CH2M | CJ2M |
| | CB3CM | CD3CM | | CF3CM | CG3CM | CH3CM | CJ3CM |

Table Top Power Options

BASE TYPE: FLUTED CYLINDER BASE

Top Shape: Round

Top Size: 36", 42", 48", 54", 60"

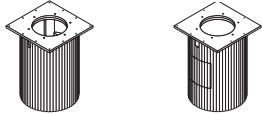











| Top Width |  |  |  |  |  |  |
|---------------------|---|---|---|--|---|---|
| For 18" base | Cutout CA NODE | Cutout CB Electrolite | Cutout CD ELLORA | Cutout CE VAULT Z23 Retractable | Cutout CF M2X | Cutout CG Ellora Double |
| 36", 42" | CA1C | CB1C | N/A | CE1C | N/A | N/A |
| Top Width |  |  |  |  |  |  |
| For 24" base | Cutout CA NODE | Cutout CB Electrolite | Cutout CD ELLORA | Cutout CE VAULT Z23 Retractable | Cutout CF M2X | Cutout CG Ellora Double |
| 48", 54", 60" | CA1C | CB1C | CD1C | CE1C | CF1C | CG1C |

Table Top Power Options

BASE TYPE: FLUTED CYLINDER BASE KIT

Top Shape: Rectangular, Soft Rectangular, Racetrack, Boat, Arc Boat, Arc Rectangular

Top Depth: 42", 48"

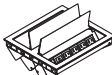
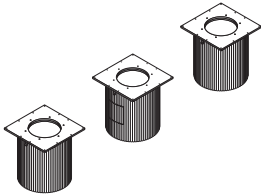

| Top Width | Cutout CB Electrolite | Cutout CD Ellora | Cutout CE Vault Z23 Retractable | Cutout CF M2X | Cutout CG Ellora Double | Cutout CH Oasis | Cutout CJ Vault BTC Rotating |
|------------|--|--|------------------------------------|--|----------------------------|-----------------------|---------------------------------|
| 102" -114" | CB1C CB2E | CD1C CD2E | CE1C CE2E | CF1C CF2E | CG1C | CH1C | CJ1C |
| 120" | CB1C CB2E CB2M CB3CE | CD1C CD2E CD2M CD3CE | CE1C CE2M | CF1C CF2E CF2M CF3CE | CG1C CG2M | CH1C | CJ1C |
| 126" -144" | CB1C CB2E CB2M CB3CE | CD1C CD2E CD2M CD3CE | CE1C CE2M CE3CE | CF1C CF2E CF2M CF3CE | CG1C CG2M | CH1C | CJ1C |
| 150" -174" | CB1C CB2E CB2M CB3CE | CD1C CD2E CD2M CD3CE | CE1C CE2M CE3CE | CF1C CF2E CF2M CF3CE | CG2M | CH2M | CJ2M |
| 180" -192" | CB1C CB2E CB2M CB3CE | CD1C CD2E CD2M CD3CE | CE1C | CF1C CF2E CF2M CF3CE | CG2M | CH2M | CJ2M |
| 198" -234" | CB1C CB2E CB2M CB3CE CB3CM | CD1C CD2E CD2M CD3CE CD3CM | CE1C CE3CM | CF1C CF2E CF2M CF3CE CF3CM | CG1C CG2M | CH1C CH2M CH3CM | CJ1C CJ2M CJ3CM |
| 240" | CB1C CB2E CB2M CB3CE CB3CM | CD1C CD2E CD2M CD3CE CD3CM | CE1C | CF1C CF2E CF2M CF3CE CF3CM | CG1C CG2M | CH1C CH2M CH3CM | CJ1C CJ2M CJ3CM |

Table Top Power Options

BASE TYPE: FLUTED CYLINDER BASE KIT

Top Shape: Rectangular, Soft Rectangular, Racetrack, Boat, Arc Boat, Arc Rectangular

Top Depth: 54", 60"

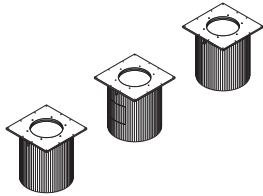

| Top Width | Cutout CB Electrolite | Cutout CD Ellora | Cutout CE Vault Z23 Retractable | Cutout CF M2X | Cutout CG Ellora Double | Cutout CH Oasis | Cutout CJ Vault BTC Rotating |
|-------------|--|--|------------------------------------|--|--|-----------------------|---------------------------------|
| 120" - 138" | CB1C CB2E CB2M CB3CE | CD1C CD2E CD3CE | CE1C CE3CE | CF1C CF2E | CG1C CG2E | CH1C | CJ1C |
| 144" - 174" | CB1C CB2E CB2M CB3CE | CD1C CD2E CD2M CD3CE | CE1C CE3CE | CF1C CF2E CF2M CF3CE | CG1C CG2E CG2M CG3CE | CH2M | CJ2M |
| 180" - 192" | CB1C CB2E CB2M CB3CE | CD1C CD2E CD2M CD3CE | CE1C | CF1C CF2E CF2M CF3CE | CG1C CG2E CG2M CG3CE | CH2M | CJ2M |
| 198" - 234" | CB1C CB2E CB2M CB3CE CB3CM | CD1C CD2E CD2M CD3CE CD3CM | CE1C CE3CM | CF1C CF2E CF2M CF3CE CF3CM | CG1C CG2E CG2M CG3CE CG3CM | CH1C CH2M CH3CM | CJ1C CJ2M CJ3CM |
| 240" | CB1C CB2E CB2M CB3CE CB3CM | CD1C CD2E CD2M CD3CE CD3CM | CE1C | CF1C CF2E CF2M CF3CE CF3CM | CG1C CG2E CG2M CG3CE CG3CM | CH1C CH2M CH3CM | CJ1C CJ2M CJ3CM |

Table Top Power Options

BASE TYPE: OBLIQUE BASE KIT

Top Shape: Rectangular, Soft Rectangular, Racetrack, Boat, Arc Boat, Arc Rectangular

Top Depth: 36", 42"

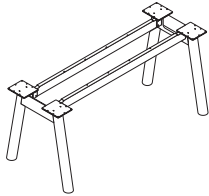

| Top Width | Cutout CB Electrolite | Cutout CD Ellora | Cutout CE Vault Z23 Retractable | Cutout CF M2X | Cutout CJ Vault BTC Rotating |
|------------|-------------------------------|-------------------------------|------------------------------------|------------------|---------------------------------|
| 72" -78" | CB1C | CD1C | CE1C | CF1C | N/A |
| 84" -96" | CB1C CB2E | CD1C CD2E | CE1C CE2E | CF1C | N/A |
| 102" -114" | CB1C CB2E CB3CE | CD1C CD2E | CE1C CE2E CE3CE | CF1C | CJ1C |
| 120" | CB1C CB2E CB2M CB3CE | CD1C CD2E CD2M CD3CE | CE1C CE2M CE3CE | CF2M | CJ2M |

Table Top Power Options

BASE TYPE: OBLIQUE BASE KIT

Top Shape: Rectangular, Soft Rectangular, Racetrack, Boat, Arc Boat, Arc Rectangular

Top Depth: 48"

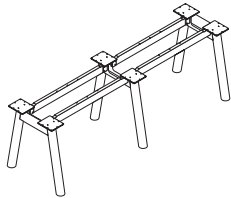

| Top Width | Cutout CB Electrolite | Cutout CD Ellora | Cutout CE Vault Z23 Retractable | Cutout CF M2X | Cutout CG Ellora Double | Cutout CH Oasis | Cutout CJ Vault BTC Rotating |
|--------------------|--|--|--|--|---|--|--|
| |  |  |  |  |  |  |  |
| 72" -96" | CB1C | CD1C | CE1C | CF1C | N/A | N/A | N/A |
| 102" -114" | CB1C CB2E CB3CE | CD1C | CE1C CE2E CE3CE | CF1C | CG1C | CH1C | CJ1C |
| 120" -138" | CB1C CB2E CB2M CB3CE | CD1C CD2E CD2M CD3CE | CE1C CE2M CE3CE | CF1C CF2E CF2M | CG1C CG2E CG2M | CH2M | CJ2M |
| 144" - 174" | CB1C CB2E CB2M CB3CE | CD1C CD2E CD2M CD3CE | CE1C CE2M CE3CE | CF1C CF2E CF2M CF3CE | CG1C CG2E CG2M CG3CE | CH2M | CJ2M |
| 180" -192" | CB1C CB2E CB2M CB3CE | CD1C CD2E CD2M CD3CE | CE1C | CF1C CF2E CF2M CF3CE | CG1C CG2E CG2M CG3CE | CH2M | CJ2M |
| 198" -234" | CB1C CB2E CB2M CB3CE CB3CM CB4ME | CD1C CD2E CD2M CD3CE CD3CM CD4ME | CE1C CE3CM CE4ME | CF1C CF2E CF2M CF3CE CF3CM | CG1C CG2E CG2M CG3CE CG3CM | CH1C CH2M CH3CM | CJ1C CJ2M CJ3CM |
| 240" | CB1C CB2E CB2M CB3CE CB3CM CB4ME | CD1C CD2E CD2M CD3CE CD3CM CD4ME | CE1C | CF1C CF2E CF2M CF3CE CF3CM | CG1C CG2E CG2M CG3CE CG3CM | CH1C CH2M CH3CM | CJ1C CJ2M CJ3CM |

Table Top Power Options

BASE TYPE: OBLIQUE BASE KIT

Top Shape: Rectangular, Soft Rectangular, Racetrack, Boat, Arc Boat, Arc Rectangular

Top Depth: 54", 60"

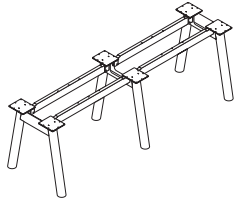

| Top Width | Cutout CB Electrolite | Cutout CD Ellora | Cutout CE Vault Z23 Retractable | Cutout CF M2X | Cutout CG Ellora Double | Cutout CH Oasis | Cutout CJ Vault BTC Rotating |
|------------|--------------------------|---------------------|------------------------------------|------------------|----------------------------|--------------------|---------------------------------|
| 120" -138" | CB1C | CD1C | CE1C | CF1C | CG1C | | |
| | CB2E | CD2E | CE2M | CF2E | CG2E | CH2M | CJ2M |
| | CB2M | CD2M | CE3CE | CF2M | CG2M | | |
| | CB3CE | CD3CE | | | | | |
| 144" -174" | CB1C | CD1C | CE1C | CF1C | CG1C | | |
| | CB2E | CD2E | CE2M | CF2E | CG2E | CH2M | CJ2M |
| | CB2M | CD2M | CE3CE | CF2M | CG2M | | |
| | CB3CE | CD3CE | | CF3CE | CG3CE | | |
| 180" -192" | CB1C | CD1C | | CF1C | CG1C | | |
| | CB2E | CD2E | CE1C | CF2E | CG2E | CH2M | CJ2M |
| | CB2M | CD2M | | CF2M | CG2M | | |
| | CB3CE | CD3CE | | CF3CE | CG3CE | | |
| 198" -234" | CB1C | CD1C | | CF1C | CG1C | | |
| | CB2E | CD2E | CE1C | CF2E | CG2E | CH1C | CJ1C |
| | CB2M | CD2M | CE3CM | CF2M | CG2M | CH2M | CJ2M |
| | CB3CE | CD3CE | CE4ME | CF3CE | CG3CE | CH3CM | CJ3CM |
| | CB3CM | CD3CM | | CF3CM | CG3CM | | |
| | CB4ME | CD4ME | | | | | |
| 240" | CB1C | CD1C | | CF1C | CG1C | | |
| | CB2E | CD2E | | CF2E | CG2E | CH1C | CJ1C |
| | CB2M | CD2M | CE1C | CF2M | CG2M | CH2M | CJ2M |
| | CB3CE | CD3CE | | CF3CE | CG3CE | CH3CM | CJ3CM |
| | CB3CM | CD3CM | | CF3CM | CG3CM | | |
| | CB4ME | CD4ME | | | | | |

Table Top Power Options

BASE TYPE: FRAME BASE KIT, RACETRACK BASE KIT

Top Shape: Rectangular, Soft Rectangular, Racetrack, Boat, Arc Boat, Arc Rectangular

Top Depth: 36", 42", 48", 54", 60"

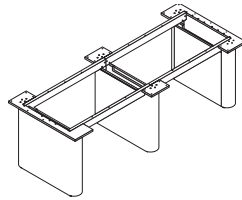
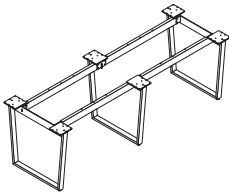

| Top Width | Cutout CB Electrolite | Cutout CD Ellora | Cutout CE Vault Z23 Retractable | Cutout CF M2X | Cutout CG Ellora Double | Cutout CH Oasis | Cutout CJ Vault BTC Rotating |
|-------------|---|---|------------------------------------|--|--|-----------------------|---------------------------------|
| | | | | | | | |
| 72" - 78" | CB1C | CD1C | CE1C | CF1C | N/A | N/A | N/A |
| 84" - 96" | CB1C CB2E | CD1C CD2E | CE1C CE2E | CF1C | N/A | N/A | N/A |
| 102" - 114" | CB1C CB2E CB3CE | CD1C CD2E | CE1C CE2E CE3CE | CF1C | CG1C | CH1C | CJ1C |
| 120" - 138" | CB1C CB2E CB2M CB3CE | CD1C CD2E CD2M CD3CE | CE1C CE2M CE3CE | CF1C CF2E CF2M | CG1C CG2E CG2M | CH2M | CJ2M |
| 144" - 174" | CB1C CB2E CB2M CB3CE | CD1C CB2E CB2M CB3CE | CE1C CE2M CE3CE | CF1C CF2E CF2M CF3CE | CG1C CG2E CG2M CG3CE | CH2M | CJ2M |
| 180" - 192" | CB1C CB2E CB2M CB3CE | CD1C CD2E CD2M CD3CE | CE1C | CF1C CF2E CF2M CF3CE | CG1C CG2E CG2M CG3CE | CH2M | CJ2M |
| 198" - 234" | CB1C CB2E CB2M CB3CE CB3CM CB4ME | CD1C CD2E CD2M CD3CE CD3CM CD4ME | CE1C CE3CM CE4ME | CF1C CF2E CF2M CF3CE CF3CM | CG1C CG2E CG2M CG3CE CG3CM | CH1C CH2M CH3CM | CJ1C CJ2M CJ3CM |
| 240" | CB1C CB2E CB2M CB3CE CB3CM CB4ME | CD1C CD2E CD2M CD3CE CD3CM CD4ME | CE1C | CF1C CF2E CF2M CF3CE CF3CM | CG1C CG2E CG2M CG3CE CG3CM | CH1C CH2M CH3CM | CJ1C CJ2M CJ3CM |

Table Top Power Options

BASE TYPE: FRAME BRIDGELINE BASE KIT, RACETRACK BRIDGELINE BASE KIT

Top Shape: Rectangular, Soft Rectangular, Racetrack, Boat, Arc Boat, Arc Rectangular

Top Depth: 48", 54", 60"

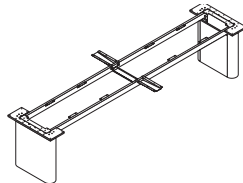
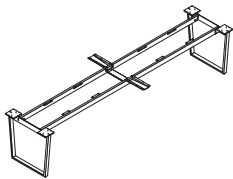

| Top Width | Cutout CB Electrolite | Cutout CD Ellora | Cutout CE Vault Z23 Retractable | Cutout CF M2X | Cutout CG Ellora Double | Cutout CH Oasis | Cutout CJ Vault BTC Rotating |
|---------------|--------------------------|---------------------|------------------------------------|------------------|----------------------------|--------------------|---------------------------------|
| 120" -174" | CB1C | CD1C | CE2M | CF1C | CG1C | CH2M | CJ2M |
| | CB2E | CD2E | | CF2E | CG2E | | |
| | CB2M | CD2M | | CF2M | CG2M | | |
| 180" -192" | CB3CE | CD3CE | N/A | CF3CE | CG3CE | CH2M | CJ2M |
| | CB1C | CD1C | | CF1C | CG1C | | |
| | CB2E | CD2E | | CF2E | CG2E | | |
| | CB2M | CD2M | | CF2M | CG2M | | |
| | CB3CE | CD3CE | | CF3CE | CG3CE | | |

Wire Management Accessories

Anthology features several bases which offer integrated wire management through the base.

Conical, Fluted, and Racetrack bases provide a pass-through for cords to the floor. All feature access to the interior of the base by a removeable panel or hinged door. Racetrack shown below.

The Frame base is available with a magnetic wire manager that is sold separately.

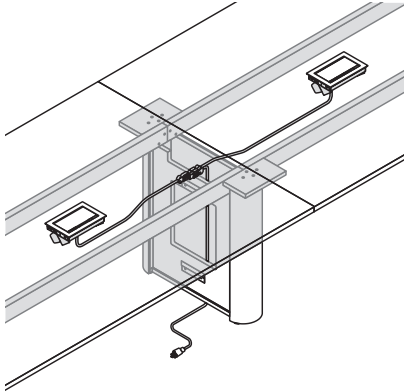

For bases without integrated wire management a Wire Management Chase is available in TFL (65T7228WCV) or Veneer (65T7228FWM) finishes that can be specified between bases to conceal cords to the floor.

A Flexible Wire Manager (9P26FWM) is available to support cords between bases and attaches to underside of top.

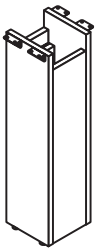

Additional cord manager accessories from other series can also be utilized such as Flexible Floor Manager GP250VWM.

Credenza Model Types and Features

WALL MOUNT CREDENZAS

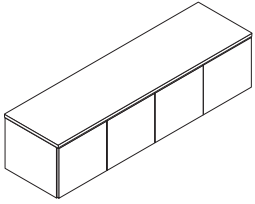

20" D
17" H
36", 60", 72", 90" W

- Separate models for laminate and veneer.
- Bottom cut-out for wire management pass-through.

LOW HEIGHT CREDENZAS

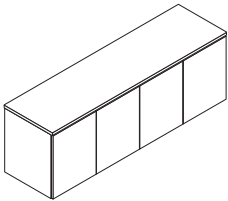

20" D
24" H
36", 60", 72", 90" W

- Separate models for laminate and veneer.
- Cut-out in back for wire management pass-through.

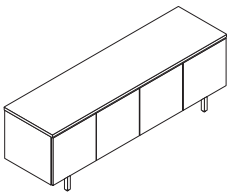

Metal inset base

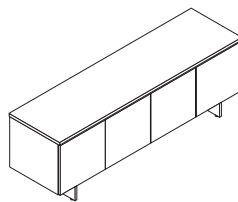

Panel inset base

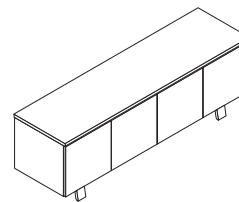

Wood inset base

Credenza Model Types and Features Continued

CONFERENCE CREDENZAS

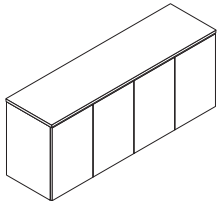

20" D
28 15/26" H
36", 60", 72", 90" W

- Separate models for laminate and veneer.
- Cut-out in back for wire management pass-through.

Credenzas - Number of Doors

36" W = 2 Doors

60" & 72" W = 4 Doors

90" W = 5 Doors

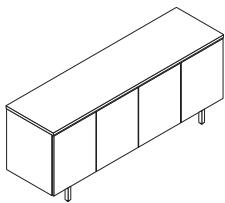

Metal inset base

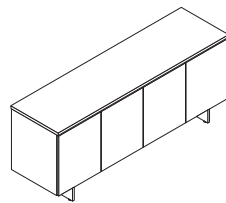

Panel inset base

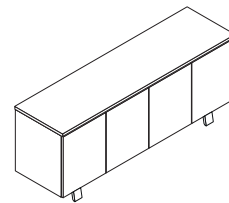

Wood inset base

BUFFET CREDENZAS

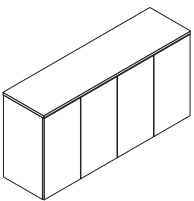

20" D
35 15/16" H
36", 60", 72", 90" W

- Separate models for laminate and veneer.
- Cut-out in back for wire management pass-through.
- Utility drawer models available in laminate (65C1727UDT) or veneer (65C1727UDV).

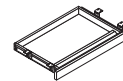

Utility Drawer

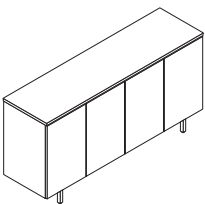

Metal inset base

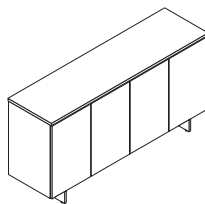

Panel inset base

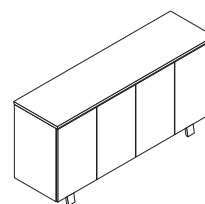

Wood inset base

Credenza Model Types and Features Continued

EQUIPMENT CREDENZAS

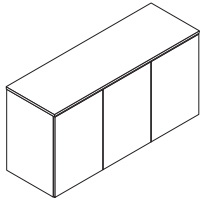

Equipment Credenzas - Number of Doors

48" W = 2 Doors

72" W = 3 Doors

24" D
 35 15/16" H
 48", 72", W

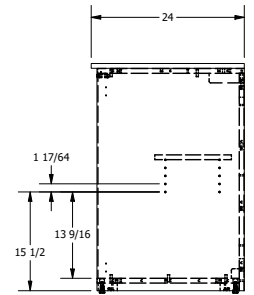
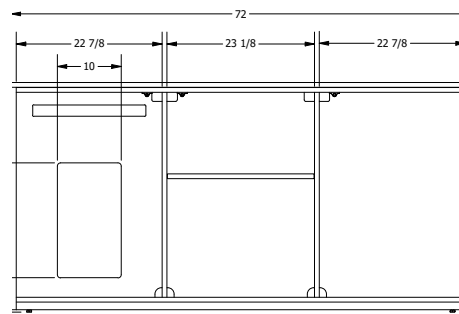

- Separate models for laminate and veneer.
- Cut-out in back for wire management pass-through.
- Inside bottom is a black HPL moisture resistant material.

Back View

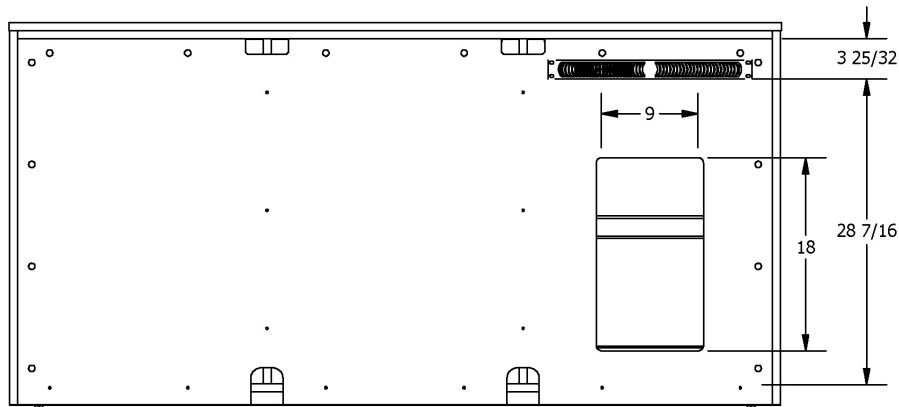

- Slide out A/V storage rack (65C19PAV) or refrigerator can be placed in the section with cut-out in back (equipment not included with credenza).
- The cut-out side determines the handed side of the credenza.

Thermostat Control Fan

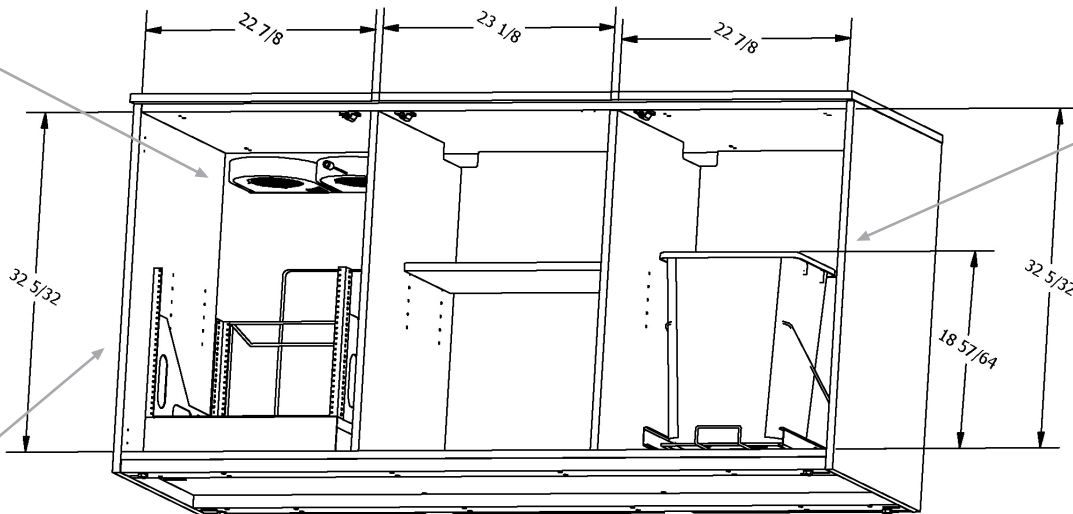

Dual Waste/Recycle Unit

Rotating AV Rack

Credenza Specification Overview

ANTHOLOGY CREDENZA

Self Edge Rim

1. Choose model by case only or inset base, finish or paint, and material and size
2. Choose base material as an option within the model number

CREDENZAS – LAMINATE SPECS

CASE ONLY

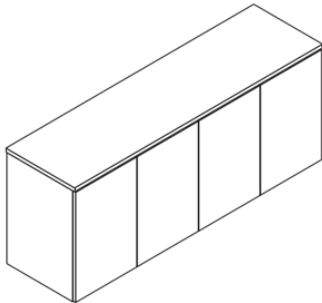

Top Surface TFL Laminate
Chassis Laminate
Door Laminate

METAL LEG

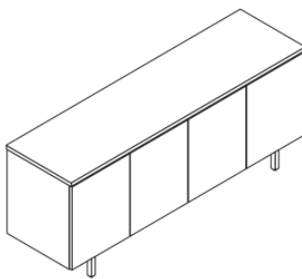

Top Surface TFL Laminate
Chassis Laminate
Door Laminate
Metal Base – Metal Paint

PANEL LEG

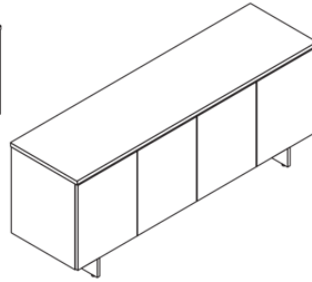

Top Surface TFL Laminate
Chassis Laminate
Door Laminate
Panel Base – matches Chassis

WOOD LEG

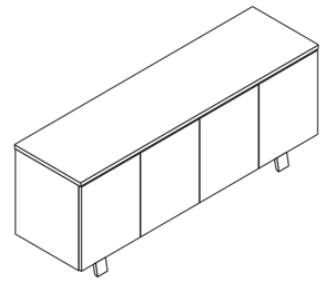

Top Surface TFL Laminate
Chassis Laminate
Door Laminate
Wood Base – Solid Wood Finish

CREDENZAS – VENEER SPECS

CASE ONLY

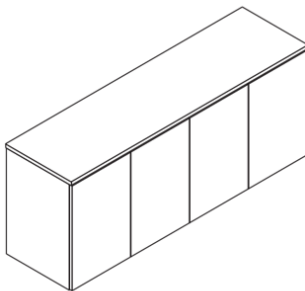

Top Surface + Chassis + Doors – Essentials/Artisan Veneer Finish
Door Fronts – can be contrasted with Wood Paint

METAL LEG

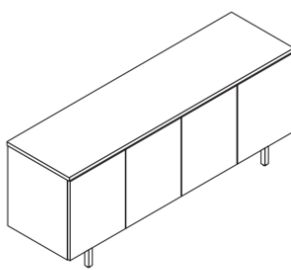

Top Surface + Chassis + Doors – Essentials/Artisan Veneer Finish
Door Fronts – can be contrasted with Wood Paint
Metal Base – Metal Paint

PANEL LEG

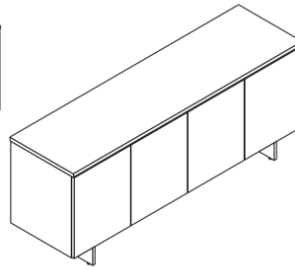

Top Surface + Chassis + Doors + Panel Base – Essentials/Artisan Veneer Finish
Door Fronts – can be contrasted with Wood Paint

WOOD LEG

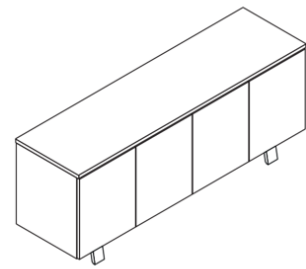

Top Surface + Chassis + Doors – Essentials/Artisan Veneer Finish
Door Fronts – can be contrasted with Wood Paint
Wood Base – Solid Wood Finish

Credenza Specification Overview Continued

3. Choose lock, grommet cutout, and power as options. The lock and grommet are not separate models. They are options chosen with the credenza model

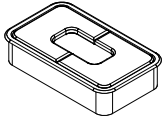

Choose a separate model for power below:
Locking is an option upcharge

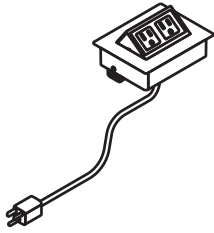

Glenbeigh
Power, Corded
(9PCK2C)

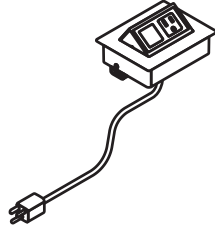

Glenbeigh
Power + Open, Corded
(9PCK1C)

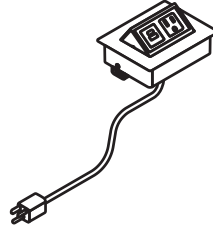

Glenbeigh
Power + USB, Corded
(9PCK11C)

4. Buffet Credenza models can accept a utility drawer specified in laminate or veneer (separate model).

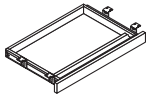

UTILITY DRAWER
-Laminate (65C1727UDT)
-Veneer (65C1727UDV)

5. Equipment Credenza models can accept the following accessories (separate models):

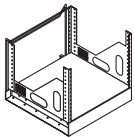

PULL OUT ROTATING AV RACK
-(65C19PAV)



DUAL WASTE/ RECYCLE UNITS
-8 GAL
-(65C2214PDW)



THERMOSTAT CONTROL FAN
-(65C1019TCF)

Credenza: Exterior Components

MATERIALS AND BASES

LAMINATE AND VENEER

3/4 top panel thickness

.5 mm edgeband

DOOR STYLE

Touch latch doors, no pulls

BASE STYLES

Metal inset, Panel inset, Wood inset

VENTILATION AND CUTOUTS

Thermostat Control Fan 65C1019TCF

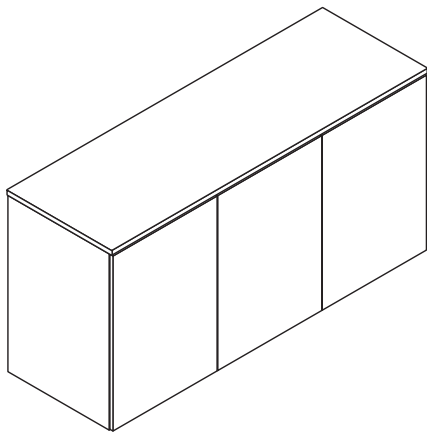

Front View

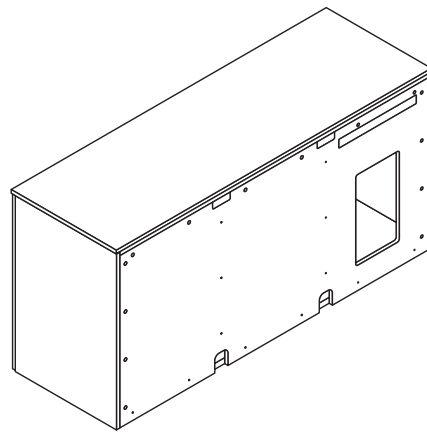

Back View

Credenza: Interior Dimensions

WALL MOUNT CREDENZA

| Width | Inside Dimension Overall | Compartment Dimension (L & R) | Compartment Dimension (Middle) |
|-------|---------------------------------------|---|--|
| 36 | 17 19/32" D x 34 3/8" W x 14 11/16" H | | |
| 60 | | 17 19/32" D x 28 13/16" W x 14 11/16" H | |
| 72 | | 17 19/32" D x 34 13/16" W x 14 11/16" H | |
| 90 | | 17 19/32" D x 34 13/16" W x 14 11/16" H | 17 19/32" D x 17 7/32" W x 14 11/16" H |

LOW HEIGHT CREDENZA

-CASE ONLY

| Width | Inside Dimension Overall | Compartment Dimension (L & R) | Compartment Dimension (Middle) |
|-------|-------------------------------------|---------------------------------------|--------------------------------------|
| 36 | 18 9/32" D x 34 3/8" W x 20 5/32" H | | |
| 60 | | 18 9/32" D x 28 13/16" W x 20 5/32" H | |
| 72 | | 18 9/32" D x 34 13/16" W x 20 5/32" H | |
| 90 | | 18 9/32" D x 34 13/16" W x 20 5/32" H | 18 9/32" D x 17 7/32" W x 20 5/32" H |

LOW HEIGHT CREDENZA

-WITH INSET BASE

| Width | Inside Dimension Overall | Compartment Dimension (L & R) | Compartment Dimension (Middle) |
|-------|------------------------------------|--------------------------------------|-------------------------------------|
| 36 | 18 9/32" D x 34 3/8" W x 15 1/4" H | | |
| 60 | | 18 9/32" D x 28 13/16" W x 15 1/4" H | |
| 72 | | 18 9/32" D x 34 13/16" W x 15 1/4" H | |
| 90 | | 18 9/32" D x 34 13/16" W x 15 1/4" H | 18 9/32" D x 17 7/32" W x 15 1/4" H |

Credenza: Interior Dimensions Continued

CONFERENCE CREDENZA

-CASE ONLY

| Width | Inside Dimension Overall | Compartment Dimension (L & R) | Compartment Dimension (Middle) |
|-------|-------------------------------------|---------------------------------------|--------------------------------------|
| 36 | 18 9/32" D x 34 3/8" W x 25 5/32" H | | |
| 60 | | 18 9/32" D x 28 13/16" W x 25 5/32" H | |
| 72 | | 18 9/32" D x 34 13/16" W x 25 5/32" H | |
| 90 | | 18 9/32" D x 34 13/16" W x 25 5/32" H | 18 9/32" D x 17 7/32" W x 25 5/32" H |

CONFERENCE CREDENZA

-WITH INSET BASE

| Width | Inside Dimension Overall | Compartment Dimension (L & R) | Compartment Dimension (Middle) |
|-------|------------------------------------|--------------------------------------|-------------------------------------|
| 36 | 18 9/32" D x 34 3/8" W x 20 1/4" H | | |
| 60 | | 18 9/32" D x 28 13/16" W x 20 1/4" H | |
| 72 | | 18 9/32" D x 34 13/16" W x 20 1/4" H | |
| 90 | | 18 9/32" D x 34 13/16" W x 20 1/4" H | 18 9/32" D x 17 7/32" W x 20 1/4" H |

BUFFET CREDENZA

-CASE ONLY

| Width | Inside Dimension Overall | Compartment Dimension (L & R) | Compartment Dimension (Middle) |
|-------|-------------------------------------|---------------------------------------|--------------------------------------|
| 36 | 18 9/32" D x 34 3/8" W x 32 5/32" H | | |
| 60 | | 18 9/32" D x 28 13/16" W x 32 5/32" H | |
| 72 | | 18 9/32" D x 34 13/16" W x 32 5/32" H | |
| 90 | | 18 9/32" D x 34 13/16" W x 32 5/32" H | 18 9/32" D x 17 7/32" W x 32 5/32" H |

Credenza: Interior Dimensions Continued

BUFFET CREDENZA -WITH INSET BASE

| Width | Inside Dimension Overall | Compartment Dimension (L & R) | Compartment Dimension (Middle) |
|-------|------------------------------------|--------------------------------------|-------------------------------------|
| 36 | 18 9/32" D x 34 3/8" W x 27 1/4" H | | |
| 60 | | 18 9/32" D x 28 13/16" W x 27 1/4" H | |
| 72 | | 18 9/32" D x 34 13/16" W x 27 1/4" H | |
| 90 | | 18 9/32" D x 34 13/16" W x 27 1/4" H | 18 9/32" D x 17 7/32" W x 27 1/4" H |

EQUIPMENT CREDENZA

| Width | Inside Dimension Overall | Compartment Dimension (L & R) | Compartment Dimension (Middle) |
|-------|-------------------------------------|---------------------------------------|-------------------------------------|
| 48 | | 22 3/16" D x 22 13/16" W x 32 5/32" H | |
| 48 | | 22 3/16" D x 22 13/16" W x 32 5/32" H | |
| 72 | | 22 3/16" D x 22 7/8" W x 32 5/32" H | 22 3/16" D x 23 1/8" W x 32 5/32" H |
| 72 | 22 3/16" D x 70 3/8" W x 32 5/32" H | 22 3/16" D x 22 7/8" W x 32 5/32" H | 22 3/16" D x 23 1/8" W x 32 5/32" H |

How to Order Tops

How to Order Tops - Suffix

When specifying a top your suffix at the end will determine if it is TFL or HPL Laminate or Veneer.

| ① Model | W | D | Top Pieces | T | H | H | KH | KH | V | V | KV | KV |
|------------|----|----|------------|-------|-------|-------|---------|---------|---------|---------|---------|---------|
| 65T3672TT_ | 72 | 36 | 1 | \$491 | \$802 | \$842 | \$1,172 | \$1,230 | \$2,122 | \$2,334 | \$2,491 | \$2,740 |
| 65T4272TT_ | 72 | 42 | 1 | \$590 | \$861 | \$904 | \$1,254 | \$1,317 | \$2,356 | \$2,592 | \$2,903 | \$3,193 |
| 65T4872TT_ | 72 | 48 | 1 | \$675 | \$866 | \$909 | \$1,258 | \$1,321 | \$2,628 | \$2,891 | \$3,154 | \$3,470 |

Example

65T36TT_

65T36TTI- TFL Laminate- Eased Edge (R3)

65T36TTH- HPL Laminate- Tier 1 or 2- Eased Edge (R3)

65T36TTKH- HPL Laminate- Tier 1 or 2- Reverse Bevel Edge (K9)

65T36TTV- Essentials or Artisan Veneer- Eased (R3), Reeded (H3) or Transitional (C3) Edge

65T36TTKV- Essentials or Artisan Veneer - Reverse Bevel Edge (K9)

Rectangular Table Tops

- planning top specification [ANPG_6](#)
- base guide [pages 38-57](#)
- planning power guide [ANPG_20- ANPG_40](#)

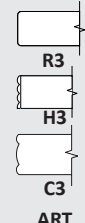
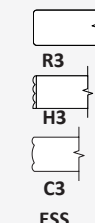
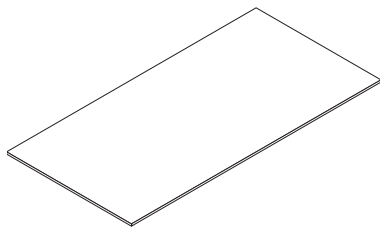

| Model | W | D | Top Pieces | R3 TFL | R3 HPL Tier 1 H | R3 HPL Tier 2 H | K9 HPL Tier 1 KH | K9 HPL Tier 2 KH | R3 H3 C3 ESS Veneer V | R3 H3 C3 ART Veneer V | K9 ESS Veneer KV | K9 ART Veneer KV |
|--------------|-----|----|------------|---------|-----------------|-----------------|------------------|------------------|-----------------------|-----------------------|------------------|------------------|
| 65T3672TT_ | 72 | 36 | 1 | \$506 | \$827 | \$868 | \$1,208 | \$1,267 | \$2,186 | \$2,405 | \$2,566 | \$2,823 |
| 65T4272TT_ | 72 | 42 | 1 | \$608 | \$887 | \$932 | \$1,292 | \$1,357 | \$2,427 | \$2,670 | \$2,991 | \$3,289 |
| 65T4872TT_ | 72 | 48 | 1 | \$696 | \$892 | \$937 | \$1,296 | \$1,361 | \$2,707 | \$2,978 | \$3,249 | \$3,575 |
| 65T3678TT_ | 78 | 36 | 1 | \$568 | \$945 | \$992 | \$1,238 | \$1,300 | \$2,349 | \$2,584 | \$2,778 | \$3,057 |
| 65T4278TT_ | 78 | 42 | 1 | \$669 | \$981 | \$1,030 | \$1,341 | \$1,407 | \$2,606 | \$2,867 | \$3,131 | \$3,444 |
| 65T4878TT_ | 78 | 48 | 1 | \$758 | \$985 | \$1,035 | \$1,346 | \$1,413 | \$2,907 | \$3,198 | \$3,471 | \$3,817 |
| 65T3684TT_ | 84 | 36 | 1 | \$629 | \$964 | \$1,011 | \$1,256 | \$1,319 | \$2,500 | \$2,751 | \$2,991 | \$3,289 |
| 65T4284TT_ | 84 | 42 | 1 | \$731 | \$1,008 | \$1,058 | \$1,355 | \$1,422 | \$2,777 | \$3,055 | \$3,415 | \$3,756 |
| 65T4884TT_ | 84 | 48 | 1 | \$819 | \$1,012 | \$1,062 | \$1,360 | \$1,428 | \$3,101 | \$3,411 | \$3,755 | \$4,130 |
| 65T3690TT_ | 90 | 36 | 1 | \$691 | \$980 | \$1,029 | \$1,273 | \$1,336 | \$2,657 | \$2,922 | \$3,203 | \$3,523 |
| 65T4290TT_ | 90 | 42 | 1 | \$793 | \$1,035 | \$1,086 | \$1,364 | \$1,432 | \$2,950 | \$3,245 | \$3,700 | \$4,070 |
| 65T4890TT_ | 90 | 48 | 1 | \$880 | \$1,039 | \$1,090 | \$1,368 | \$1,437 | \$3,298 | \$3,627 | \$4,006 | \$4,407 |
| 65T3696TT_ | 96 | 36 | 1 | \$752 | \$998 | \$1,047 | \$1,290 | \$1,355 | \$2,810 | \$3,092 | \$3,415 | \$3,756 |
| 65T4296TT_ | 96 | 42 | 1 | \$854 | \$1,061 | \$1,115 | \$1,372 | \$1,441 | \$3,120 | \$3,432 | \$3,986 | \$4,384 |
| 65T4896TT_ | 96 | 48 | 1 | \$942 | \$1,067 | \$1,119 | \$1,377 | \$1,446 | \$3,450 | \$3,795 | \$3,986 | \$4,384 |
| 65T42102TT1_ | 102 | 42 | 1 | \$886 | \$1,559 | \$1,636 | \$2,120 | \$2,226 | \$3,570 | \$3,928 | \$4,012 | \$4,413 |
| 65T48102TT1_ | 102 | 48 | 1 | \$953 | \$1,567 | \$1,645 | \$2,145 | \$2,252 | \$3,901 | \$4,290 | \$4,694 | \$5,164 |
| 65T42102TT2_ | 102 | 42 | 2 | \$1,098 | \$1,676 | \$1,760 | \$2,281 | \$2,395 | \$3,840 | \$4,225 | \$4,313 | \$4,745 |
| 65T48102TT2_ | 102 | 48 | 2 | \$1,210 | \$1,685 | \$1,769 | \$2,307 | \$2,422 | \$4,195 | \$4,614 | \$5,047 | \$5,552 |
| 65T42108TT1_ | 108 | 42 | 1 | \$934 | \$1,583 | \$1,662 | \$2,125 | \$2,231 | \$3,732 | \$4,105 | \$4,254 | \$4,680 |
| 65T48108TT1_ | 108 | 48 | 1 | \$1,015 | \$1,590 | \$1,670 | \$2,170 | \$2,278 | \$4,062 | \$4,469 | \$4,936 | \$5,430 |
| 65T42108TT2_ | 108 | 42 | 2 | \$1,153 | \$1,702 | \$1,787 | \$2,285 | \$2,399 | \$4,013 | \$4,415 | \$4,574 | \$5,031 |
| 65T48108TT2_ | 108 | 48 | 2 | \$1,270 | \$1,710 | \$1,796 | \$2,332 | \$2,450 | \$4,368 | \$4,804 | \$5,308 | \$5,839 |
| 65T42114TT1_ | 114 | 42 | 1 | \$981 | \$1,607 | \$1,688 | \$2,150 | \$2,257 | \$3,913 | \$4,305 | \$4,528 | \$4,981 |
| 65T48114TT1_ | 114 | 48 | 1 | \$1,077 | \$1,615 | \$1,695 | \$2,194 | \$2,304 | \$4,288 | \$4,717 | \$4,528 | \$4,981 |
| 65T42114TT2_ | 114 | 42 | 2 | \$1,209 | \$1,728 | \$1,814 | \$2,311 | \$2,426 | \$4,208 | \$4,629 | \$4,868 | \$5,355 |
| 65T48114TT2_ | 114 | 48 | 2 | \$1,332 | \$1,737 | \$1,824 | \$2,358 | \$2,477 | \$4,611 | \$5,071 | \$5,602 | \$6,162 |

| Model | TFL Top Surface | HPL Top Surface | Top Profile | Veneer Top Material | Top Surface Power Cutout |
|-------|--|--|---|--|--|
| | see Anthology TFL Top Surface Finishes | see Anthology HPL Top Surface Finishes | see Anthology Top Profile Finishes (when applicable) | see Anthology Veneer Top Material Finishes | see Anthology Top Surface Power Cutout |

Rectangular Table Tops (continued)

- planning top specification [ANPG_6](#)
- base guide [pages 38-57](#)
- planning power guide [ANPG_20- ANPG_40](#)

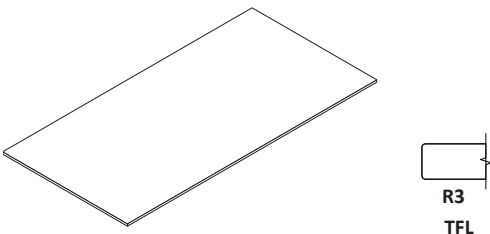

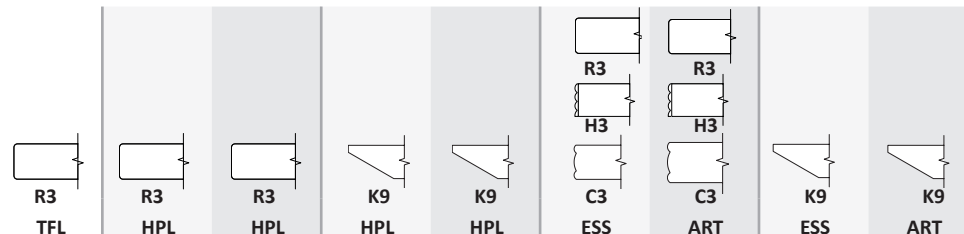
| ① Model | W | D | Top Pieces |  | | | | | | | | | |
|--------------|-----|----|------------|--|---------|---------|---------|---------|---------|---------|---------|----------|--|
| | | | | T | H | H | KH | KH | V | V | KV | KV | |
| 65T42120TT1_ | 120 | 42 | 1 | \$1,029 | \$1,631 | \$1,712 | \$2,173 | \$2,282 | \$4,096 | \$4,506 | \$4,800 | \$5,280 | |
| 65T48120TT1_ | 120 | 48 | 1 | \$1,139 | \$1,639 | \$1,721 | \$2,217 | \$2,328 | \$4,513 | \$4,964 | \$5,484 | \$6,032 | |
| 65T54120TT1_ | 120 | 54 | 1 | \$1,247 | \$1,842 | \$1,934 | \$2,498 | \$2,623 | \$4,975 | \$5,473 | \$6,010 | \$6,611 | |
| 65T60120TT1_ | 120 | 60 | 1 | \$1,355 | \$1,861 | \$1,953 | \$2,524 | \$2,650 | \$5,642 | \$6,206 | \$6,859 | \$7,545 | |
| 65T42120TT2_ | 120 | 42 | 2 | \$1,263 | \$1,754 | \$1,841 | \$2,337 | \$2,453 | \$4,404 | \$4,844 | \$5,162 | \$5,679 | |
| 65T48120TT2_ | 120 | 48 | 2 | \$1,394 | \$1,762 | \$1,850 | \$2,385 | \$2,504 | \$4,853 | \$5,338 | \$5,896 | \$6,486 | |
| 65T54120TT2_ | 120 | 54 | 2 | \$1,525 | \$1,980 | \$2,080 | \$2,686 | \$2,821 | \$5,350 | \$5,885 | \$6,462 | \$7,107 | |
| 65T60120TT2_ | 120 | 60 | 2 | \$1,655 | \$2,001 | \$2,101 | \$2,714 | \$2,849 | \$6,066 | \$6,673 | \$7,375 | \$8,113 | |
| 65T48126TT_ | 126 | 48 | 2 | \$1,452 | \$1,804 | \$1,895 | \$2,487 | \$2,611 | \$5,096 | \$5,605 | \$6,194 | \$6,813 | |
| 65T54126TT_ | 126 | 54 | 2 | \$1,585 | \$2,089 | \$2,193 | \$2,949 | \$3,097 | \$5,590 | \$6,149 | \$6,753 | \$7,429 | |
| 65T60126TT_ | 126 | 60 | 2 | \$1,724 | \$2,111 | \$2,217 | \$2,980 | \$3,129 | \$6,370 | \$7,007 | \$7,742 | \$8,517 | |
| 65T48132TT_ | 132 | 48 | 2 | \$1,508 | \$1,847 | \$1,939 | \$2,589 | \$2,718 | \$5,338 | \$5,873 | \$6,491 | \$7,139 | |
| 65T54132TT_ | 132 | 54 | 2 | \$1,648 | \$2,199 | \$2,308 | \$3,213 | \$3,374 | \$5,828 | \$6,411 | \$7,046 | \$7,750 | |
| 65T60132TT_ | 132 | 60 | 2 | \$1,793 | \$2,220 | \$2,331 | \$3,246 | \$3,409 | \$6,672 | \$7,339 | \$8,110 | \$8,920 | |
| 65T48138TT_ | 138 | 48 | 2 | \$1,565 | \$1,890 | \$1,984 | \$2,692 | \$2,826 | \$5,580 | \$6,138 | \$6,785 | \$7,464 | |
| 65T54138TT_ | 138 | 54 | 2 | \$1,712 | \$2,203 | \$2,313 | \$3,220 | \$3,381 | \$6,068 | \$6,675 | \$7,505 | \$8,255 | |
| 65T60138TT_ | 138 | 60 | 2 | \$1,862 | \$2,224 | \$2,336 | \$3,252 | \$3,415 | \$6,976 | \$7,673 | \$8,479 | \$9,327 | |
| 65T48144TT_ | 144 | 48 | 2 | \$1,621 | \$1,931 | \$2,028 | \$2,792 | \$2,932 | \$5,823 | \$6,405 | \$7,079 | \$7,786 | |
| 65T54144TT_ | 144 | 54 | 2 | \$1,776 | \$2,208 | \$2,318 | \$3,225 | \$3,386 | \$6,306 | \$6,937 | \$7,964 | \$8,761 | |
| 65T60144TT_ | 144 | 60 | 2 | \$1,931 | \$2,230 | \$2,342 | \$3,258 | \$3,421 | \$7,278 | \$8,007 | \$8,850 | \$9,735 | |
| 65T48150TT_ | 150 | 48 | 2 | \$1,678 | \$2,016 | \$2,117 | \$2,865 | \$3,009 | \$6,066 | \$6,673 | \$7,373 | \$8,111 | |
| 65T54150TT_ | 150 | 54 | 2 | \$1,838 | \$2,420 | \$2,540 | \$3,414 | \$3,585 | \$6,544 | \$7,198 | \$8,258 | \$9,084 | |
| 65T60150TT_ | 150 | 60 | 2 | \$2,000 | \$2,446 | \$2,567 | \$3,441 | \$3,613 | \$7,582 | \$8,340 | \$9,216 | \$10,138 | |
| 65T48156TT_ | 156 | 48 | 2 | \$1,735 | \$2,105 | \$2,210 | \$2,939 | \$3,085 | \$6,308 | \$6,939 | \$7,667 | \$8,434 | |
| 65T54156TT_ | 156 | 54 | 2 | \$1,901 | \$2,634 | \$2,766 | \$3,587 | \$3,766 | \$6,780 | \$7,458 | \$8,553 | \$9,409 | |
| 65T60156TT_ | 156 | 60 | 2 | \$2,069 | \$2,661 | \$2,794 | \$3,623 | \$3,804 | \$7,885 | \$8,674 | \$9,583 | \$10,542 | |

| Model | TFL Top Surface | HPL Top Surface | Top Profile | Veneer Top Material | Top Surface Power Cutout |
|-------|--|--|---|--|--|
| | see Anthology TFL Top Surface Finishes | see Anthology HPL Top Surface Finishes | see Anthology Top Profile Finishes (when applicable) | see Anthology Veneer Top Material Finishes | see Anthology Top Surface Power Cutout |

Rectangular Table Tops (continued)

- planning top specification [ANPG_6](#)
- base guide [pages 38-57](#)
- planning power guide [ANPG_20- ANPG_40](#)

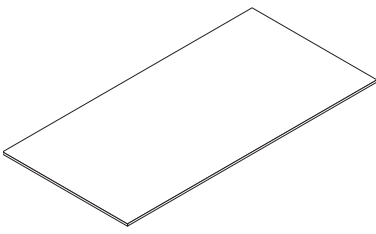

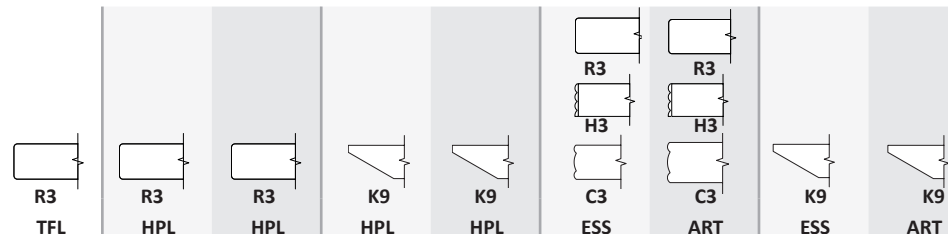
| ① Model | W | D | Top Pieces |  | | | | | | | | | |
|-------------|-----|----|------------|--|---------|---------|---------|---------|----------|----------|----------|----------|--|
| | | | | T | H | H | KH | KH | V | V | KV | KV | |
| 65T48162TT_ | 162 | 48 | 2 | \$1,792 | \$2,185 | \$2,294 | \$3,011 | \$3,162 | \$6,551 | \$7,206 | \$7,962 | \$8,759 | |
| 65T54162TT_ | 162 | 54 | 2 | \$1,964 | \$2,637 | \$2,769 | \$3,592 | \$3,771 | \$7,192 | \$7,911 | \$8,922 | \$9,814 | |
| 65T60162TT_ | 162 | 60 | 2 | \$2,138 | \$2,664 | \$2,797 | \$3,629 | \$3,810 | \$8,189 | \$9,008 | \$9,953 | \$10,948 | |
| 65T48168TT_ | 168 | 48 | 2 | \$1,848 | \$2,270 | \$2,383 | \$3,083 | \$3,237 | \$6,794 | \$7,473 | \$8,255 | \$9,080 | |
| 65T54168TT_ | 168 | 54 | 2 | \$2,027 | \$2,641 | \$2,773 | \$3,599 | \$3,780 | \$7,605 | \$8,365 | \$9,292 | \$10,221 | |
| 65T60168TT_ | 168 | 60 | 2 | \$2,207 | \$2,669 | \$2,802 | \$3,636 | \$3,819 | \$8,492 | \$9,341 | \$10,323 | \$11,356 | |
| 65T48174TT_ | 174 | 48 | 2 | \$1,904 | \$2,274 | \$2,387 | \$3,089 | \$3,244 | \$7,035 | \$7,739 | \$8,553 | \$9,409 | |
| 65T54174TT_ | 174 | 54 | 2 | \$2,089 | \$2,643 | \$2,776 | \$3,604 | \$3,785 | \$7,868 | \$8,655 | \$9,587 | \$10,545 | |
| 65T60174TT_ | 174 | 60 | 2 | \$2,276 | \$2,671 | \$2,805 | \$3,642 | \$3,824 | \$8,795 | \$9,674 | \$10,690 | \$11,758 | |
| 65T48180TT_ | 180 | 48 | 2 | \$1,961 | \$2,277 | \$2,390 | \$3,095 | \$3,249 | \$7,278 | \$8,007 | \$8,850 | \$9,735 | |
| 65T54180TT_ | 180 | 54 | 2 | \$2,151 | \$2,652 | \$2,785 | \$3,613 | \$3,793 | \$8,130 | \$8,944 | \$9,880 | \$10,868 | |
| 65T60180TT_ | 180 | 60 | 2 | \$2,345 | \$2,680 | \$2,813 | \$3,650 | \$3,832 | \$9,098 | \$10,008 | \$11,057 | \$12,162 | |
| 65T48186TT_ | 186 | 48 | 2 | \$2,018 | \$2,281 | \$2,395 | \$3,102 | \$3,257 | \$7,522 | \$8,273 | \$9,144 | \$10,058 | |
| 65T54186TT_ | 186 | 54 | 2 | \$2,215 | \$2,657 | \$2,789 | \$3,618 | \$3,798 | \$8,377 | \$9,216 | \$10,247 | \$11,272 | |
| 65T60186TT_ | 186 | 60 | 2 | \$2,414 | \$2,683 | \$2,818 | \$3,655 | \$3,837 | \$9,401 | \$10,342 | \$11,427 | \$12,570 | |
| 65T48192TT_ | 192 | 48 | 2 | \$2,075 | \$2,286 | \$2,400 | \$3,108 | \$3,264 | \$7,764 | \$8,540 | \$9,437 | \$10,382 | |
| 65T54192TT_ | 192 | 54 | 2 | \$2,279 | \$2,661 | \$2,794 | \$3,623 | \$3,804 | \$8,627 | \$9,490 | \$10,615 | \$11,676 | |
| 65T60192TT_ | 192 | 60 | 2 | \$2,484 | \$2,687 | \$2,822 | \$3,661 | \$3,844 | \$9,705 | \$10,675 | \$11,797 | \$12,976 | |
| 65T48198TT_ | 198 | 48 | 2 | \$2,150 | \$3,182 | \$3,342 | \$4,296 | \$4,510 | \$8,863 | \$9,748 | \$10,719 | \$11,790 | |
| 65T54198TT_ | 198 | 54 | 2 | \$2,360 | \$3,623 | \$3,804 | \$4,934 | \$5,180 | \$9,862 | \$10,848 | \$11,867 | \$13,054 | |
| 65T60198TT_ | 198 | 60 | 2 | \$2,572 | \$3,661 | \$3,844 | \$4,984 | \$5,233 | \$11,069 | \$12,176 | \$13,321 | \$14,653 | |
| 65T48204TT_ | 204 | 48 | 2 | \$2,224 | \$3,226 | \$3,387 | \$4,379 | \$4,598 | \$9,122 | \$10,035 | \$10,978 | \$12,076 | |
| 65T54204TT_ | 204 | 54 | 2 | \$2,443 | \$3,631 | \$3,813 | \$4,940 | \$5,188 | \$10,196 | \$11,216 | \$12,270 | \$13,498 | |
| 65T60204TT_ | 204 | 60 | 2 | \$2,662 | \$3,669 | \$3,853 | \$4,992 | \$5,241 | \$11,403 | \$12,543 | \$13,726 | \$15,098 | |
| 65T48210TT_ | 210 | 48 | 2 | \$2,300 | \$3,231 | \$3,392 | \$4,387 | \$4,606 | \$9,389 | \$10,327 | \$11,300 | \$12,430 | |
| 65T54210TT_ | 210 | 54 | 2 | \$2,524 | \$3,635 | \$3,818 | \$4,947 | \$5,194 | \$10,529 | \$11,582 | \$12,674 | \$13,941 | |
| 65T60210TT_ | 210 | 60 | 2 | \$2,751 | \$3,672 | \$3,857 | \$4,998 | \$5,247 | \$11,736 | \$12,911 | \$14,129 | \$15,542 | |

| Model | TFL Top Surface | HPL Top Surface | Top Profile | Veneer Top Material | Top Surface Power Cutout |
|-------|--|--|--|--|--|
| | see Anthology TFL Top Surface Finishes | see Anthology HPL Top Surface Finishes | see Anthology Top Profile Finishes (when applicable) | see Anthology Veneer Top Material Finishes | see Anthology Top Surface Power Cutout |

Rectangular Table Tops (continued)

- planning top specification [ANPG_6](#)
- base guide [pages 38-57](#)
- planning power guide [ANPG_20- ANPG_40](#)

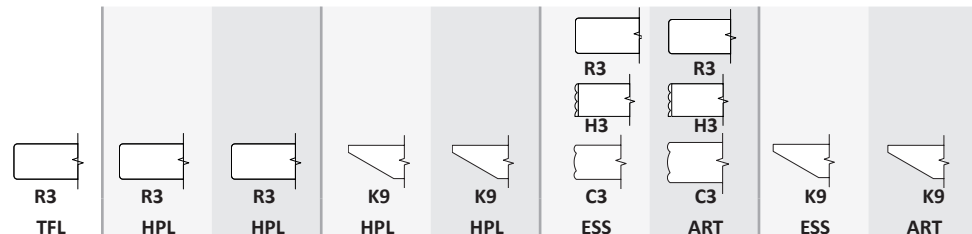
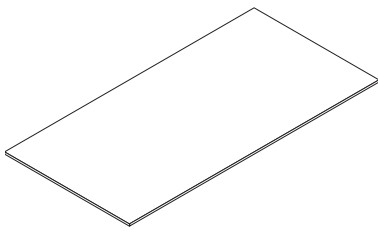

| ① Model | W | D | Top Pieces | R3 TFL T | R3 HPL Tier 1 H | R3 HPL Tier 2 H | K9 HPL Tier 1 KH | K9 HPL Tier 2 KH | R3 H3 C3 ESS Veneer V | R3 H3 C3 ART Veneer V | K9 ESS Veneer KV | K9 ART Veneer KV |
|-------------|-----|----|------------|-------------|--------------------|--------------------|---------------------|---------------------|-----------------------------|-----------------------------|------------------------|------------------------|
| 65T48216TT_ | 216 | 48 | 3 | \$2,375 | \$3,235 | \$3,396 | \$4,394 | \$4,614 | \$9,657 | \$10,622 | \$11,621 | \$12,783 |
| 65T54216TT_ | 216 | 54 | 3 | \$2,605 | \$3,639 | \$3,822 | \$4,953 | \$5,200 | \$10,864 | \$11,950 | \$13,076 | \$14,384 |
| 65T60216TT_ | 216 | 60 | 3 | \$2,840 | \$3,677 | \$3,861 | \$5,003 | \$5,253 | \$12,070 | \$13,277 | \$14,532 | \$15,985 |
| 65T48222TT_ | 222 | 48 | 3 | \$2,450 | \$3,239 | \$3,401 | \$4,400 | \$4,619 | \$9,926 | \$10,918 | \$11,945 | \$13,140 |
| 65T54222TT_ | 222 | 54 | 3 | \$2,687 | \$3,696 | \$3,881 | \$5,031 | \$5,282 | \$11,133 | \$12,246 | \$13,401 | \$14,741 |
| 65T60222TT_ | 222 | 60 | 3 | \$2,929 | \$3,734 | \$3,921 | \$5,083 | \$5,337 | \$12,407 | \$13,648 | \$14,935 | \$16,429 |
| 65T48228TT_ | 228 | 48 | 3 | \$2,525 | \$3,243 | \$3,406 | \$4,406 | \$4,626 | \$10,196 | \$11,216 | \$12,270 | \$13,498 |
| 65T54228TT_ | 228 | 54 | 3 | \$2,769 | \$3,753 | \$3,940 | \$5,108 | \$5,364 | \$11,403 | \$12,543 | \$13,726 | \$15,098 |
| 65T60228TT_ | 228 | 60 | 3 | \$3,018 | \$3,792 | \$3,981 | \$5,161 | \$5,419 | \$12,744 | \$14,018 | \$15,338 | \$16,872 |
| 65T48234TT_ | 234 | 48 | 3 | \$2,600 | \$3,370 | \$3,538 | \$4,471 | \$4,694 | \$10,462 | \$11,509 | \$12,592 | \$13,851 |
| 65T54234TT_ | 234 | 54 | 3 | \$2,851 | \$3,758 | \$3,945 | \$5,114 | \$5,370 | \$11,736 | \$12,911 | \$14,129 | \$15,542 |
| 65T60234TT_ | 234 | 60 | 3 | \$3,107 | \$3,797 | \$3,987 | \$5,168 | \$5,426 | \$13,076 | \$14,384 | \$15,742 | \$17,316 |
| 65T48240TT_ | 240 | 48 | 3 | \$2,675 | \$3,496 | \$3,671 | \$4,536 | \$4,762 | \$10,730 | \$11,803 | \$12,914 | \$14,204 |
| 65T54240TT_ | 240 | 54 | 3 | \$2,935 | \$3,763 | \$3,951 | \$5,122 | \$5,378 | \$12,070 | \$13,277 | \$14,532 | \$15,985 |
| 65T60240TT_ | 240 | 60 | 3 | \$3,197 | \$3,802 | \$3,993 | \$5,174 | \$5,433 | \$13,411 | \$14,752 | \$16,146 | \$17,760 |

| Model | TFL Top Surface | HPL Top Surface | Top Profile | Veneer Top Material | Top Surface Power Cutout |
|-------|--|--|--|--|--|
| | see Anthology TFL Top Surface Finishes | see Anthology HPL Top Surface Finishes | see Anthology Top Profile Finishes (when applicable) | see Anthology Veneer Top Material Finishes | see Anthology Top Surface Power Cutout |

Soft Rectangular Table Tops

- 3" radius corners
- planning top specification [ANPG_6](#)
- base guide [pages 38-57](#)
- planning power guide [ANPG_20- ANPG_40](#)

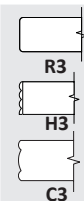
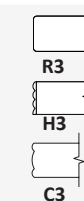
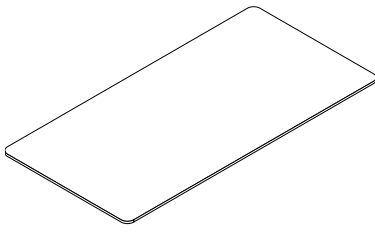

| Model | W | D | Top Pieces | TFL T | HPL Tier 1 H | HPL Tier 2 H | HPL Tier 1 KH | HPL Tier 2 KH | ESS Veneer V | ART Veneer V | ESS Veneer KV | ART Veneer KV |
|--------------|-----|----|------------|----------|-----------------|-----------------|------------------|------------------|-----------------|-----------------|------------------|------------------|
| 65T3672SR_ | 72 | 36 | 1 | \$506 | \$827 | \$868 | \$1,208 | \$1,267 | \$2,186 | \$2,405 | \$2,566 | \$2,823 |
| 65T4272SR_ | 72 | 42 | 1 | \$608 | \$887 | \$932 | \$1,292 | \$1,357 | \$2,427 | \$2,670 | \$2,991 | \$3,289 |
| 65T4872SR_ | 72 | 48 | 1 | \$696 | \$892 | \$937 | \$1,296 | \$1,361 | \$2,707 | \$2,978 | \$3,249 | \$3,575 |
| 65T3678SR_ | 78 | 36 | 1 | \$568 | \$945 | \$992 | \$1,238 | \$1,300 | \$2,349 | \$2,584 | \$2,778 | \$3,057 |
| 65T4278SR_ | 78 | 42 | 1 | \$669 | \$981 | \$1,030 | \$1,341 | \$1,407 | \$2,606 | \$2,867 | \$3,131 | \$3,444 |
| 65T4878SR_ | 78 | 48 | 1 | \$758 | \$985 | \$1,035 | \$1,346 | \$1,413 | \$2,907 | \$3,198 | \$3,471 | \$3,817 |
| 65T3684SR_ | 84 | 36 | 1 | \$629 | \$964 | \$1,011 | \$1,256 | \$1,319 | \$2,500 | \$2,751 | \$2,991 | \$3,289 |
| 65T4284SR_ | 84 | 42 | 1 | \$731 | \$1,008 | \$1,058 | \$1,355 | \$1,422 | \$2,777 | \$3,055 | \$3,415 | \$3,756 |
| 65T4884SR_ | 84 | 48 | 1 | \$819 | \$1,012 | \$1,062 | \$1,360 | \$1,428 | \$3,101 | \$3,411 | \$3,755 | \$4,130 |
| 65T3690SR_ | 90 | 36 | 1 | \$691 | \$980 | \$1,029 | \$1,273 | \$1,336 | \$2,657 | \$2,922 | \$3,203 | \$3,523 |
| 65T4290SR_ | 90 | 42 | 1 | \$793 | \$1,035 | \$1,086 | \$1,364 | \$1,432 | \$2,950 | \$3,245 | \$3,700 | \$4,070 |
| 65T4890SR_ | 90 | 48 | 1 | \$880 | \$1,039 | \$1,090 | \$1,368 | \$1,437 | \$3,298 | \$3,627 | \$4,006 | \$4,407 |
| 65T3696SR_ | 96 | 36 | 1 | \$752 | \$998 | \$1,047 | \$1,290 | \$1,355 | \$2,810 | \$3,092 | \$3,415 | \$3,756 |
| 65T4296SR_ | 96 | 42 | 1 | \$854 | \$1,061 | \$1,115 | \$1,372 | \$1,441 | \$3,120 | \$3,432 | \$3,986 | \$4,384 |
| 65T4896SR_ | 96 | 48 | 1 | \$942 | \$1,067 | \$1,119 | \$1,377 | \$1,446 | \$3,450 | \$3,795 | \$4,259 | \$4,684 |
| 65T42102SR1_ | 102 | 42 | 1 | \$886 | \$3,120 | \$3,276 | \$2,120 | \$2,226 | \$3,570 | \$3,928 | \$4,012 | \$4,413 |
| 65T48102SR1_ | 102 | 48 | 1 | \$953 | \$3,450 | \$3,622 | \$2,145 | \$2,252 | \$3,901 | \$4,290 | \$4,694 | \$5,164 |
| 65T42102SR2_ | 102 | 42 | 2 | \$1,098 | \$1,676 | \$1,760 | \$2,281 | \$2,395 | \$3,840 | \$4,225 | \$4,313 | \$4,745 |
| 65T48102SR2_ | 102 | 48 | 2 | \$1,210 | \$1,685 | \$1,769 | \$2,307 | \$2,422 | \$4,195 | \$4,614 | \$5,047 | \$5,552 |
| 65T42108SR1_ | 108 | 42 | 1 | \$934 | \$1,583 | \$1,662 | \$2,125 | \$2,231 | \$3,732 | \$4,105 | \$4,254 | \$4,680 |
| 65T48108SR1_ | 108 | 48 | 1 | \$1,015 | \$1,590 | \$1,670 | \$2,170 | \$2,278 | \$4,062 | \$4,469 | \$4,936 | \$5,430 |
| 65T42108SR2_ | 108 | 42 | 2 | \$1,153 | \$1,702 | \$1,787 | \$2,285 | \$2,399 | \$4,013 | \$4,415 | \$4,574 | \$5,031 |
| 65T48108SR2_ | 108 | 48 | 2 | \$1,270 | \$1,710 | \$1,796 | \$2,332 | \$2,450 | \$4,368 | \$4,804 | \$5,308 | \$5,839 |
| 65T42114SR1_ | 114 | 42 | 1 | \$981 | \$1,607 | \$1,688 | \$2,150 | \$2,257 | \$3,913 | \$4,305 | \$4,528 | \$4,981 |
| 65T48114SR1_ | 114 | 48 | 1 | \$1,077 | \$1,615 | \$1,695 | \$2,194 | \$2,304 | \$4,288 | \$4,717 | \$5,209 | \$5,729 |
| 65T42114SR2_ | 114 | 42 | 2 | \$1,209 | \$1,728 | \$1,814 | \$2,311 | \$2,426 | \$4,208 | \$4,629 | \$4,868 | \$5,355 |
| 65T48114SR2_ | 114 | 48 | 2 | \$1,332 | \$1,737 | \$1,824 | \$2,358 | \$2,477 | \$4,611 | \$5,071 | \$5,602 | \$6,162 |

| Model | TFL Top Surface | HPL Top Surface | Top Profile | Veneer Top Material | Top Surface Power Cutout |
|-------|--|--|--|--|--|
| | see Anthology TFL Top Surface Finishes | see Anthology HPL Top Surface Finishes | see Anthology Top Profile Finishes (when applicable) | see Anthology Veneer Top Material Finishes | see Anthology Top Surface Power Cutout |

Soft Rectangular Table Tops (continued)

- 3" radius corners
- planning top specification [ANPG_6](#)
- base guide [pages 38-57](#)
- planning power guide [ANPG_20- ANPG_40](#)

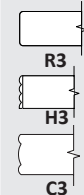
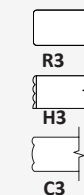
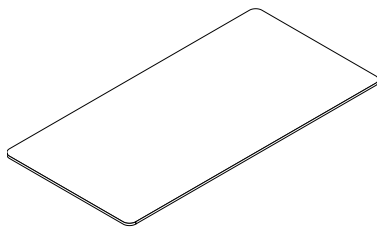

| Model | W | D | Top Pieces | TFL R3 T | HPL Tier 1 R3 H | HPL Tier 2 R3 H | HPL Tier 1 K9 KH | HPL Tier 2 K9 KH | ESS Veneer V R3 H3 C3 | ART Veneer V R3 H3 C3 | ESS Veneer KV K9 | ART Veneer KV K9 |
|--------------|-----|----|------------|----------------|-----------------------|-----------------------|------------------------|------------------------|-----------------------------------|-----------------------------------|------------------------|------------------------|
| 65T42120SR1_ | 120 | 42 | 1 | \$1,029 | \$1,631 | \$1,712 | \$2,173 | \$2,282 | \$4,096 | \$4,506 | \$4,800 | \$5,280 |
| 65T48120SR1_ | 120 | 48 | 1 | \$1,139 | \$1,639 | \$1,721 | \$2,217 | \$2,328 | \$4,513 | \$4,964 | \$5,484 | \$6,032 |
| 65T54120SR1_ | 120 | 54 | 1 | \$1,247 | \$1,842 | \$1,934 | \$2,498 | \$2,623 | \$4,975 | \$5,473 | \$6,010 | \$6,611 |
| 65T60120SR1_ | 120 | 60 | 1 | \$1,355 | \$1,861 | \$1,953 | \$2,524 | \$2,650 | \$5,642 | \$6,206 | \$6,859 | \$7,545 |
| 65T42120SR2_ | 120 | 42 | 2 | \$1,263 | \$1,754 | \$1,841 | \$2,337 | \$2,453 | \$4,404 | \$4,844 | \$5,162 | \$5,679 |
| 65T48120SR2_ | 120 | 48 | 2 | \$1,394 | \$1,762 | \$1,850 | \$2,385 | \$2,504 | \$4,853 | \$5,338 | \$5,896 | \$6,486 |
| 65T54120SR2_ | 120 | 54 | 2 | \$1,525 | \$1,980 | \$2,080 | \$2,686 | \$2,821 | \$5,350 | \$5,885 | \$6,462 | \$7,107 |
| 65T60120SR2_ | 120 | 60 | 2 | \$1,655 | \$2,001 | \$2,101 | \$2,714 | \$2,849 | \$6,066 | \$6,673 | \$7,375 | \$8,113 |
| 65T48126SR_ | 126 | 48 | 2 | \$1,452 | \$1,804 | \$1,895 | \$2,487 | \$2,611 | \$5,096 | \$5,605 | \$6,194 | \$6,813 |
| 65T54126SR_ | 126 | 54 | 2 | \$1,585 | \$2,089 | \$2,193 | \$2,949 | \$3,097 | \$5,590 | \$6,149 | \$6,753 | \$7,429 |
| 65T60126SR_ | 126 | 60 | 2 | \$1,724 | \$2,111 | \$2,217 | \$2,980 | \$3,129 | \$6,370 | \$7,007 | \$7,742 | \$8,517 |
| 65T48132SR_ | 132 | 48 | 2 | \$1,508 | \$1,847 | \$1,939 | \$2,589 | \$2,718 | \$5,338 | \$5,873 | \$6,491 | \$7,139 |
| 65T54132SR_ | 132 | 54 | 2 | \$1,648 | \$2,199 | \$2,308 | \$3,213 | \$3,374 | \$5,828 | \$6,411 | \$7,046 | \$7,750 |
| 65T60132SR_ | 132 | 60 | 2 | \$1,793 | \$2,220 | \$2,331 | \$3,246 | \$3,409 | \$6,672 | \$7,339 | \$8,110 | \$8,920 |
| 65T48138SR_ | 138 | 48 | 2 | \$1,565 | \$1,890 | \$1,984 | \$2,692 | \$2,826 | \$5,580 | \$6,138 | \$6,785 | \$7,464 |
| 65T54138SR_ | 138 | 54 | 2 | \$1,712 | \$2,203 | \$2,313 | \$3,220 | \$3,381 | \$6,068 | \$6,675 | \$7,505 | \$8,255 |
| 65T60138SR_ | 138 | 60 | 2 | \$1,862 | \$2,224 | \$2,336 | \$3,252 | \$3,415 | \$6,976 | \$7,673 | \$8,479 | \$9,327 |
| 65T48144SR_ | 144 | 48 | 2 | \$1,621 | \$1,931 | \$2,028 | \$2,792 | \$2,932 | \$5,823 | \$6,405 | \$7,079 | \$7,786 |
| 65T54144SR_ | 144 | 54 | 2 | \$1,776 | \$2,208 | \$2,318 | \$3,225 | \$3,386 | \$6,306 | \$6,937 | \$7,964 | \$8,761 |
| 65T60144SR_ | 144 | 60 | 2 | \$1,931 | \$2,230 | \$2,342 | \$3,258 | \$3,421 | \$7,278 | \$8,007 | \$8,850 | \$9,735 |
| 65T48150SR_ | 150 | 48 | 2 | \$1,678 | \$2,016 | \$2,117 | \$2,865 | \$3,009 | \$6,066 | \$6,673 | \$7,373 | \$8,111 |
| 65T54150SR_ | 150 | 54 | 2 | \$1,838 | \$2,420 | \$2,540 | \$3,414 | \$3,585 | \$6,544 | \$7,198 | \$8,258 | \$9,084 |
| 65T60150SR_ | 150 | 60 | 2 | \$2,000 | \$2,446 | \$2,567 | \$3,441 | \$3,613 | \$7,582 | \$8,340 | \$9,216 | \$10,138 |
| 65T48156SR_ | 156 | 48 | 2 | \$1,735 | \$2,105 | \$2,210 | \$2,939 | \$3,085 | \$6,308 | \$6,939 | \$7,667 | \$8,434 |
| 65T54156SR_ | 156 | 54 | 2 | \$1,901 | \$2,634 | \$2,766 | \$3,587 | \$3,766 | \$6,780 | \$7,458 | \$8,553 | \$9,409 |
| 65T60156SR_ | 156 | 60 | 2 | \$2,069 | \$2,661 | \$2,794 | \$3,623 | \$3,804 | \$7,885 | \$8,674 | \$9,583 | \$10,542 |

| Model | TFL Top Surface | HPL Top Surface | Top Profile | Veneer Top Material | Top Surface Power Cutout |
|-------|--|--|--|--|--|
| | see Anthology TFL Top Surface Finishes | see Anthology HPL Top Surface Finishes | see Anthology Top Profile Finishes (when applicable) | see Anthology Veneer Top Material Finishes | see Anthology Top Surface Power Cutout |

Soft Rectangular Table Tops (continued)

- 3" radius corners
- planning top specification [ANPG_6](#)
- base guide [pages 38-57](#)
- planning power guide [ANPG_20- ANPG_40](#)

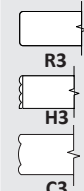
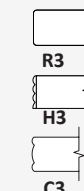
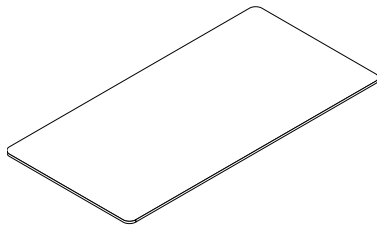

| Model | W | D | Top Pieces | TFL R3 T | HPL Tier 1 R3 H | HPL Tier 2 R3 H | HPL Tier 1 K9 KH | HPL Tier 2 K9 KH | ESS Veneer R3 H3 C3 V | ART Veneer R3 H3 C3 V | ESS Veneer K9 KV | ART Veneer K9 KV |
|-------------|-----|----|------------|----------------|-----------------------|-----------------------|------------------------|------------------------|-----------------------------------|-----------------------------------|------------------------|------------------------|
| 65T48162SR_ | 162 | 48 | 2 | \$1,792 | \$2,185 | \$2,294 | \$3,011 | \$3,162 | \$6,551 | \$7,206 | \$7,962 | \$8,759 |
| 65T54162SR_ | 162 | 54 | 2 | \$1,964 | \$2,637 | \$2,769 | \$3,592 | \$3,771 | \$7,192 | \$7,911 | \$8,922 | \$9,814 |
| 65T60162SR_ | 162 | 60 | 2 | \$2,138 | \$2,664 | \$2,797 | \$3,629 | \$3,810 | \$8,189 | \$9,008 | \$9,953 | \$10,948 |
| 65T48168SR_ | 168 | 48 | 2 | \$1,848 | \$2,270 | \$2,383 | \$3,083 | \$3,237 | \$6,794 | \$7,473 | \$8,255 | \$9,080 |
| 65T54168SR_ | 168 | 54 | 2 | \$2,027 | \$2,641 | \$2,773 | \$3,599 | \$3,780 | \$7,605 | \$8,365 | \$9,292 | \$10,221 |
| 65T60168SR_ | 168 | 60 | 2 | \$2,207 | \$2,669 | \$2,802 | \$3,636 | \$3,819 | \$8,492 | \$9,341 | \$10,323 | \$11,356 |
| 65T48174SR_ | 174 | 48 | 2 | \$1,904 | \$2,274 | \$2,387 | \$3,089 | \$3,244 | \$7,035 | \$7,739 | \$8,553 | \$9,409 |
| 65T54174SR_ | 174 | 54 | 2 | \$2,089 | \$2,643 | \$2,776 | \$3,604 | \$3,785 | \$7,868 | \$8,655 | \$9,587 | \$10,545 |
| 65T60174SR_ | 174 | 60 | 2 | \$2,276 | \$2,671 | \$2,805 | \$3,642 | \$3,824 | \$8,795 | \$9,674 | \$10,690 | \$11,758 |
| 65T48180SR_ | 180 | 48 | 2 | \$1,961 | \$2,277 | \$2,390 | \$3,095 | \$3,249 | \$7,278 | \$8,007 | \$8,850 | \$9,735 |
| 65T54180SR_ | 180 | 54 | 2 | \$2,151 | \$2,652 | \$2,785 | \$3,613 | \$3,793 | \$8,130 | \$8,944 | \$9,880 | \$10,868 |
| 65T60180SR_ | 180 | 60 | 2 | \$2,345 | \$2,680 | \$2,813 | \$3,650 | \$3,832 | \$9,098 | \$10,008 | \$11,057 | \$12,162 |
| 65T48186SR_ | 186 | 48 | 2 | \$2,018 | \$2,281 | \$2,395 | \$3,102 | \$3,257 | \$7,522 | \$8,273 | \$9,144 | \$10,058 |
| 65T54186SR_ | 186 | 54 | 2 | \$2,215 | \$2,657 | \$2,789 | \$3,618 | \$3,798 | \$8,377 | \$9,216 | \$10,247 | \$11,272 |
| 65T60186SR_ | 186 | 60 | 2 | \$2,414 | \$2,683 | \$2,818 | \$3,655 | \$3,837 | \$9,401 | \$10,342 | \$11,427 | \$12,570 |
| 65T48192SR_ | 192 | 48 | 2 | \$2,075 | \$2,286 | \$2,400 | \$3,108 | \$3,264 | \$7,764 | \$8,540 | \$9,437 | \$10,382 |
| 65T54192SR_ | 192 | 54 | 2 | \$2,279 | \$2,661 | \$2,794 | \$3,623 | \$3,804 | \$8,627 | \$9,490 | \$10,615 | \$11,676 |
| 65T60192SR_ | 192 | 60 | 2 | \$2,484 | \$2,687 | \$2,822 | \$3,661 | \$3,844 | \$9,705 | \$10,675 | \$11,797 | \$12,976 |
| 65T48198SR_ | 198 | 48 | 3 | \$2,150 | \$3,182 | \$3,342 | \$4,296 | \$4,510 | \$8,863 | \$9,748 | \$10,719 | \$11,790 |
| 65T54198SR_ | 198 | 54 | 3 | \$2,360 | \$3,623 | \$3,804 | \$4,934 | \$5,180 | \$9,862 | \$10,848 | \$11,867 | \$13,054 |
| 65T60198SR_ | 198 | 60 | 3 | \$2,572 | \$3,661 | \$3,844 | \$4,984 | \$5,233 | \$11,069 | \$12,176 | \$13,321 | \$14,653 |
| 65T48204SR_ | 204 | 48 | 3 | \$2,224 | \$3,226 | \$3,387 | \$4,379 | \$4,598 | \$9,122 | \$10,035 | \$10,978 | \$12,076 |
| 65T54204SR_ | 204 | 54 | 3 | \$2,443 | \$3,631 | \$3,813 | \$4,940 | \$5,188 | \$10,196 | \$11,216 | \$12,270 | \$13,498 |
| 65T60204SR_ | 204 | 60 | 3 | \$2,662 | \$3,669 | \$3,853 | \$4,992 | \$5,241 | \$11,403 | \$12,543 | \$13,726 | \$15,098 |
| 65T48210SR_ | 210 | 48 | 3 | \$2,300 | \$3,231 | \$3,392 | \$4,387 | \$4,606 | \$9,389 | \$10,327 | \$11,300 | \$12,430 |
| 65T54210SR_ | 210 | 54 | 3 | \$2,524 | \$3,635 | \$3,818 | \$4,947 | \$5,194 | \$10,529 | \$11,582 | \$12,674 | \$13,941 |
| 65T60210SR_ | 210 | 60 | 3 | \$2,751 | \$3,672 | \$3,857 | \$4,998 | \$5,247 | \$11,736 | \$12,911 | \$14,129 | \$15,542 |

| Model | TFL Top Surface | HPL Top Surface | Top Profile | Veneer Top Material | Top Surface Power Cutout |
|-------|--|--|--|--|--|
| | see Anthology TFL Top Surface Finishes | see Anthology HPL Top Surface Finishes | see Anthology Top Profile Finishes (when applicable) | see Anthology Veneer Top Material Finishes | see Anthology Top Surface Power Cutout |

Soft Rectangular Table Tops (continued)

- 3" radius corners
- planning top specification [ANPG_6](#)
- base guide [pages 38-57](#)
- planning power guide [ANPG_20- ANPG_40](#)

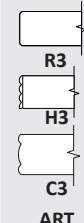
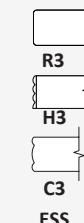
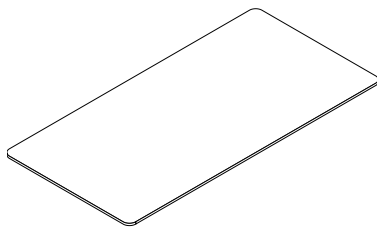

| ① Model | W | D | Top Pieces | R3 TFL T | R3 HPL Tier 1 H | R3 HPL Tier 2 H | K9 HPL Tier 1 KH | K9 HPL Tier 2 KH | R3 H3 C3 ESS Veneer V | R3 H3 C3 ART Veneer V | K9 ESS Veneer KV | K9 ART Veneer KV |
|-------------|-----|----|------------|----------|-----------------|-----------------|------------------|------------------|-----------------------|-----------------------|------------------|------------------|
| 65T48216SR_ | 216 | 48 | 3 | \$2,375 | \$3,235 | \$3,396 | \$4,394 | \$4,614 | \$9,657 | \$10,622 | \$11,621 | \$12,783 |
| 65T54216SR_ | 216 | 54 | 3 | \$2,605 | \$3,639 | \$3,822 | \$4,953 | \$5,200 | \$10,864 | \$11,950 | \$13,076 | \$14,384 |
| 65T60216SR_ | 216 | 60 | 3 | \$2,840 | \$3,677 | \$3,861 | \$5,003 | \$5,253 | \$12,070 | \$13,277 | \$14,532 | \$15,985 |
| 65T48222SR_ | 222 | 48 | 3 | \$2,450 | \$3,239 | \$3,401 | \$4,400 | \$4,619 | \$9,926 | \$10,918 | \$11,945 | \$13,140 |
| 65T54222SR_ | 222 | 54 | 3 | \$2,687 | \$3,696 | \$3,881 | \$5,031 | \$5,282 | \$11,133 | \$12,246 | \$13,401 | \$14,741 |
| 65T60222SR_ | 222 | 60 | 3 | \$2,929 | \$3,734 | \$3,921 | \$5,083 | \$5,337 | \$12,407 | \$13,648 | \$14,935 | \$16,429 |
| 65T48228SR_ | 228 | 48 | 3 | \$2,525 | \$3,243 | \$3,406 | \$4,406 | \$4,626 | \$10,196 | \$11,216 | \$12,270 | \$13,498 |
| 65T54228SR_ | 228 | 54 | 3 | \$2,769 | \$3,753 | \$3,940 | \$5,108 | \$5,364 | \$11,403 | \$12,543 | \$13,726 | \$15,098 |
| 65T60228SR_ | 228 | 60 | 3 | \$3,018 | \$3,792 | \$3,981 | \$5,161 | \$5,419 | \$12,744 | \$14,018 | \$15,338 | \$16,872 |
| 65T48234SR_ | 234 | 48 | 3 | \$2,600 | \$3,370 | \$3,538 | \$4,471 | \$4,694 | \$10,462 | \$11,509 | \$12,592 | \$13,851 |
| 65T54234SR_ | 234 | 54 | 3 | \$2,851 | \$3,758 | \$3,945 | \$5,114 | \$5,370 | \$11,736 | \$12,911 | \$14,129 | \$15,542 |
| 65T60234SR_ | 234 | 60 | 3 | \$3,107 | \$3,797 | \$3,987 | \$5,168 | \$5,426 | \$13,076 | \$14,384 | \$15,742 | \$17,316 |
| 65T48240SR_ | 240 | 48 | 3 | \$2,675 | \$3,496 | \$3,671 | \$4,536 | \$4,762 | \$10,730 | \$11,803 | \$12,914 | \$14,204 |
| 65T54240SR_ | 240 | 54 | 3 | \$2,935 | \$3,763 | \$3,951 | \$5,122 | \$5,378 | \$12,070 | \$13,277 | \$14,532 | \$15,985 |
| 65T60240SR_ | 240 | 60 | 3 | \$3,197 | \$3,802 | \$3,993 | \$5,174 | \$5,433 | \$13,411 | \$14,752 | \$16,146 | \$17,760 |

| Model | TFL Top Surface | HPL Top Surface | Top Profile | Veneer Top Material | Top Surface Power Cutout |
|-------|--|--|--|--|--|
| | see Anthology TFL Top Surface Finishes | see Anthology HPL Top Surface Finishes | see Anthology Top Profile Finishes (when applicable) | see Anthology Veneer Top Material Finishes | see Anthology Top Surface Power Cutout |

Arc Rectangular Table Tops

- planning top specification [ANPG_6](#)
- base guide [pages 38-57](#)
- planning power guide [ANPG_20- ANPG_40](#)

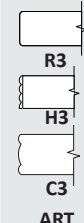
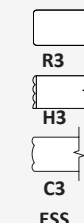
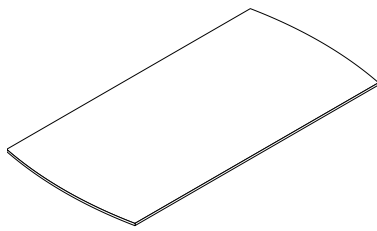

| Model | W | D | Top Pieces | R3 TFL T | R3 HPL Tier 1 H | R3 HPL Tier 2 H | K9 HPL Tier 1 KH | K9 HPL Tier 2 KH | R3 H3 C3 ESS Veneer V | R3 H3 C3 ART Veneer V | K9 ESS Veneer KV | K9 ART Veneer KV |
|--------------|-----|----|------------|----------|-----------------|-----------------|------------------|------------------|-----------------------|-----------------------|------------------|------------------|
| 65T3672AR_ | 72 | 36 | 1 | \$506 | \$827 | \$868 | \$1,208 | \$1,267 | \$2,186 | \$2,405 | \$2,566 | \$2,823 |
| 65T4272AR_ | 72 | 42 | 1 | \$608 | \$887 | \$932 | \$1,292 | \$1,357 | \$2,427 | \$2,670 | \$2,991 | \$3,289 |
| 65T4872AR_ | 72 | 48 | 1 | \$696 | \$892 | \$937 | \$1,296 | \$1,361 | \$2,707 | \$2,978 | \$3,249 | \$3,575 |
| 65T3678AR_ | 78 | 36 | 1 | \$568 | \$945 | \$992 | \$1,238 | \$1,300 | \$2,349 | \$2,584 | \$2,778 | \$3,057 |
| 65T4278AR_ | 78 | 42 | 1 | \$669 | \$981 | \$1,030 | \$1,341 | \$1,407 | \$2,606 | \$2,867 | \$3,131 | \$3,444 |
| 65T4878AR_ | 78 | 48 | 1 | \$758 | \$985 | \$1,035 | \$1,346 | \$1,413 | \$2,907 | \$3,198 | \$3,471 | \$3,817 |
| 65T3684AR_ | 84 | 36 | 1 | \$629 | \$964 | \$1,011 | \$1,256 | \$1,319 | \$2,500 | \$2,751 | \$2,991 | \$3,289 |
| 65T4284AR_ | 84 | 42 | 1 | \$731 | \$1,008 | \$1,058 | \$1,355 | \$1,422 | \$2,777 | \$3,055 | \$3,415 | \$3,756 |
| 65T4884AR_ | 84 | 48 | 1 | \$819 | \$1,012 | \$1,062 | \$1,360 | \$1,428 | \$3,101 | \$3,411 | \$3,755 | \$4,130 |
| 65T3690AR_ | 90 | 36 | 1 | \$691 | \$980 | \$1,029 | \$1,273 | \$1,336 | \$2,657 | \$2,922 | \$3,203 | \$3,523 |
| 65T4290AR_ | 90 | 42 | 1 | \$793 | \$1,035 | \$1,086 | \$1,364 | \$1,432 | \$2,950 | \$3,245 | \$3,700 | \$4,070 |
| 65T4890AR_ | 90 | 48 | 1 | \$880 | \$1,039 | \$1,090 | \$1,368 | \$1,437 | \$3,298 | \$3,627 | \$3,700 | \$4,070 |
| 65T3696AR_ | 96 | 36 | 1 | \$752 | \$998 | \$1,047 | \$1,290 | \$1,355 | \$2,810 | \$3,092 | \$3,415 | \$3,756 |
| 65T4296AR_ | 96 | 42 | 1 | \$854 | \$1,061 | \$1,115 | \$1,372 | \$1,441 | \$3,120 | \$3,432 | \$3,986 | \$4,384 |
| 65T4896AR_ | 96 | 48 | 1 | \$942 | \$1,067 | \$1,119 | \$1,377 | \$1,446 | \$3,450 | \$3,795 | \$3,986 | \$4,384 |
| 65T42102AR1_ | 102 | 42 | 1 | \$886 | \$1,559 | \$1,636 | \$2,120 | \$2,226 | \$3,570 | \$3,928 | \$4,012 | \$4,413 |
| 65T48102AR1_ | 102 | 48 | 1 | \$953 | \$1,567 | \$1,645 | \$2,145 | \$2,252 | \$3,901 | \$4,290 | \$4,694 | \$5,164 |
| 65T42102AR2_ | 102 | 42 | 2 | \$1,098 | \$1,676 | \$1,760 | \$2,281 | \$2,395 | \$3,840 | \$4,225 | \$4,313 | \$4,745 |
| 65T48102AR2_ | 102 | 48 | 2 | \$1,210 | \$1,685 | \$1,769 | \$2,307 | \$2,422 | \$4,195 | \$4,614 | \$5,047 | \$5,552 |
| 65T42108AR1_ | 108 | 42 | 1 | \$934 | \$1,583 | \$1,662 | \$2,125 | \$2,231 | \$3,732 | \$4,105 | \$4,254 | \$4,680 |
| 65T48108AR1_ | 108 | 48 | 1 | \$1,015 | \$1,590 | \$1,670 | \$2,170 | \$2,278 | \$4,062 | \$4,469 | \$4,936 | \$5,430 |
| 65T42108AR2_ | 108 | 42 | 2 | \$1,153 | \$1,702 | \$1,787 | \$2,285 | \$2,399 | \$4,013 | \$4,415 | \$4,574 | \$5,031 |
| 65T48108AR2_ | 108 | 48 | 2 | \$1,270 | \$1,710 | \$1,796 | \$2,332 | \$2,450 | \$4,368 | \$4,804 | \$5,308 | \$5,839 |
| 65T42114AR1_ | 114 | 42 | 1 | \$981 | \$1,607 | \$1,688 | \$2,150 | \$2,257 | \$3,913 | \$4,305 | \$4,528 | \$4,981 |
| 65T48114AR1_ | 114 | 48 | 1 | \$1,077 | \$1,615 | \$1,695 | \$2,194 | \$2,304 | \$4,288 | \$4,717 | \$5,209 | \$5,729 |
| 65T42114AR2_ | 114 | 42 | 2 | \$1,209 | \$1,728 | \$1,814 | \$2,311 | \$2,426 | \$4,208 | \$4,629 | \$4,868 | \$5,355 |
| 65T48114AR2_ | 114 | 48 | 2 | \$1,332 | \$1,737 | \$1,824 | \$2,358 | \$2,477 | \$4,611 | \$5,071 | \$5,602 | \$6,162 |

| Model | TFL Top Surface | HPL Top Surface | Top Profile | Veneer Top Material | Top Surface Power Cutout |
|-------|--|--|--|--|--|
| | see Anthology TFL Top Surface Finishes | see Anthology HPL Top Surface Finishes | see Anthology Top Profile Finishes (when applicable) | see Anthology Veneer Top Material Finishes | see Anthology Top Surface Power Cutout |

Arc Rectangular Table Tops (continued)

- planning top specification [ANPG_6](#)
- base guide [pages 38-57](#)
- planning power guide [ANPG_20- ANPG_40](#)

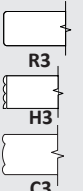
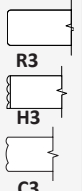
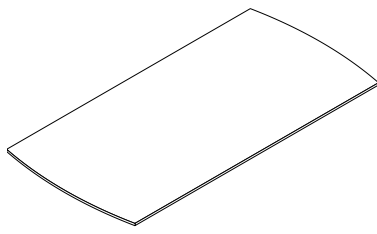

| Model | W | D | Top Pieces | TFL R3 T | HPL Tier 1 R3 H | HPL Tier 2 R3 H | HPL Tier 1 K9 KH | HPL Tier 2 K9 KH | ESS Veneer R3 H3 C3 V | ART Veneer R3 H3 C3 V | ESS Veneer K9 KV | ART Veneer K9 KV |
|--------------|-----|----|------------|----------------|-----------------------|-----------------------|------------------------|------------------------|-----------------------------------|-----------------------------------|------------------------|------------------------|
| 65T42120AR1_ | 120 | 42 | 1 | \$1,029 | \$1,631 | \$1,712 | \$2,173 | \$2,282 | \$4,096 | \$4,506 | \$4,800 | \$5,280 |
| 65T48120AR1_ | 120 | 48 | 1 | \$1,139 | \$1,639 | \$1,721 | \$2,217 | \$2,328 | \$4,513 | \$4,964 | \$5,484 | \$6,032 |
| 65T54120AR1_ | 120 | 54 | 1 | \$1,247 | \$1,842 | \$1,934 | \$2,498 | \$2,623 | \$4,975 | \$5,473 | \$6,010 | \$6,611 |
| 65T60120AR1_ | 120 | 60 | 1 | \$1,355 | \$1,861 | \$1,953 | \$2,524 | \$2,650 | \$5,642 | \$6,206 | \$6,859 | \$7,545 |
| 65T42120AR2_ | 120 | 42 | 2 | \$1,263 | \$1,754 | \$1,841 | \$2,337 | \$2,453 | \$4,404 | \$4,844 | \$5,162 | \$5,679 |
| 65T48120AR2_ | 120 | 48 | 2 | \$1,394 | \$1,762 | \$1,850 | \$2,385 | \$2,504 | \$4,853 | \$5,338 | \$5,896 | \$6,486 |
| 65T54120AR2_ | 120 | 54 | 2 | \$1,525 | \$1,980 | \$2,080 | \$2,686 | \$2,821 | \$5,350 | \$5,885 | \$6,462 | \$7,107 |
| 65T60120AR2_ | 120 | 60 | 2 | \$1,655 | \$2,001 | \$2,101 | \$2,714 | \$2,849 | \$6,066 | \$6,673 | \$7,375 | \$8,113 |
| 65T48126AR_ | 126 | 48 | 2 | \$1,452 | \$1,804 | \$1,895 | \$2,487 | \$2,611 | \$5,096 | \$5,605 | \$6,194 | \$6,813 |
| 65T54126AR_ | 126 | 54 | 2 | \$1,585 | \$2,089 | \$2,193 | \$2,949 | \$3,097 | \$5,590 | \$6,149 | \$6,753 | \$7,429 |
| 65T60126AR_ | 126 | 60 | 2 | \$1,724 | \$2,111 | \$2,217 | \$2,980 | \$3,129 | \$6,370 | \$7,007 | \$7,742 | \$8,517 |
| 65T48132AR_ | 132 | 48 | 2 | \$1,508 | \$1,847 | \$1,939 | \$2,589 | \$2,718 | \$5,338 | \$5,873 | \$6,491 | \$7,139 |
| 65T54132AR_ | 132 | 54 | 2 | \$1,648 | \$2,199 | \$2,308 | \$3,213 | \$3,374 | \$5,828 | \$6,411 | \$7,046 | \$7,750 |
| 65T60132AR_ | 132 | 60 | 2 | \$1,793 | \$2,220 | \$2,331 | \$3,246 | \$3,409 | \$6,672 | \$7,339 | \$8,110 | \$8,920 |
| 65T48138AR_ | 138 | 48 | 2 | \$1,565 | \$1,890 | \$1,984 | \$2,692 | \$2,826 | \$5,580 | \$6,138 | \$6,785 | \$7,464 |
| 65T54138AR_ | 138 | 54 | 2 | \$1,712 | \$2,203 | \$2,313 | \$3,220 | \$3,381 | \$6,068 | \$6,675 | \$7,505 | \$8,255 |
| 65T60138AR_ | 138 | 60 | 2 | \$1,862 | \$2,224 | \$2,336 | \$3,252 | \$3,415 | \$6,976 | \$7,673 | \$8,479 | \$9,327 |
| 65T48144AR_ | 144 | 48 | 2 | \$1,621 | \$1,931 | \$2,028 | \$2,792 | \$2,932 | \$5,823 | \$6,405 | \$7,079 | \$7,786 |
| 65T54144AR_ | 144 | 54 | 2 | \$1,776 | \$2,208 | \$2,318 | \$3,225 | \$3,386 | \$6,306 | \$6,937 | \$7,964 | \$8,761 |
| 65T60144AR_ | 144 | 60 | 2 | \$1,931 | \$2,230 | \$2,342 | \$3,258 | \$3,421 | \$7,278 | \$8,007 | \$8,850 | \$9,735 |
| 65T48150AR_ | 150 | 48 | 2 | \$1,678 | \$2,016 | \$2,117 | \$2,865 | \$3,009 | \$6,066 | \$6,673 | \$7,373 | \$8,111 |
| 65T54150AR_ | 150 | 54 | 2 | \$1,838 | \$2,420 | \$2,540 | \$3,414 | \$3,585 | \$6,544 | \$7,198 | \$8,258 | \$9,084 |
| 65T60150AR_ | 150 | 60 | 2 | \$2,000 | \$2,446 | \$2,567 | \$3,441 | \$3,613 | \$7,582 | \$8,340 | \$9,216 | \$10,138 |
| 65T48156AR_ | 156 | 48 | 2 | \$1,735 | \$2,105 | \$2,210 | \$2,939 | \$3,085 | \$6,308 | \$6,939 | \$7,667 | \$8,434 |
| 65T54156AR_ | 156 | 54 | 2 | \$1,901 | \$2,634 | \$2,766 | \$3,587 | \$3,766 | \$6,780 | \$7,458 | \$8,553 | \$9,409 |
| 65T60156AR_ | 156 | 60 | 2 | \$2,069 | \$2,661 | \$2,794 | \$3,623 | \$3,804 | \$7,885 | \$8,674 | \$9,583 | \$10,542 |

| Model | TFL Top Surface | HPL Top Surface | Top Profile | Veneer Top Material | Top Surface Power Cutout |
|-------|--|--|--|--|--|
| | see Anthology TFL Top Surface Finishes | see Anthology HPL Top Surface Finishes | see Anthology Top Profile Finishes (when applicable) | see Anthology Veneer Top Material Finishes | see Anthology Top Surface Power Cutout |

Arc Rectangular Table Tops (continued)

- planning top specification [ANPG_6](#)
- base guide [pages 38-57](#)
- planning power guide [ANPG_20- ANPG_40](#)

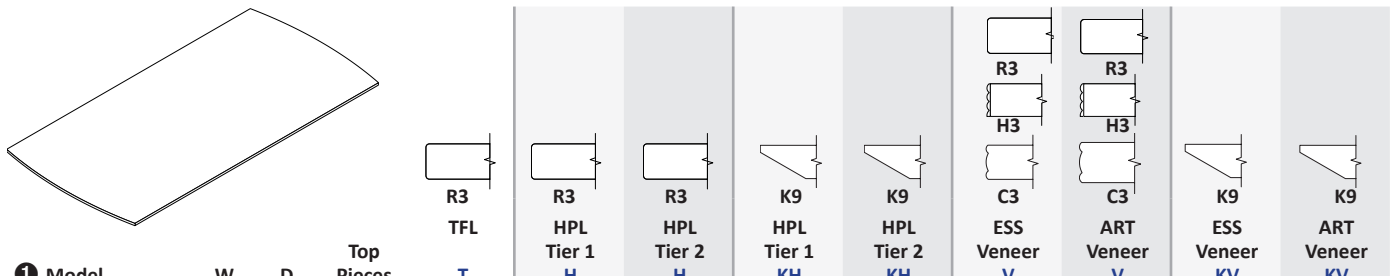

| Model | W | D | Top Pieces | TFL R3 | HPL Tier 1 R3 | HPL Tier 2 R3 | HPL Tier 1 K9 | HPL Tier 2 K9 | ESS Veneer V | ART Veneer V | ESS Veneer KV | ART Veneer KV |
|-------------|-----|----|------------|-----------|------------------|------------------|------------------|------------------|-----------------|-----------------|------------------|------------------|
| 65T48162AR_ | 162 | 48 | 2 | \$1,792 | \$2,185 | \$2,294 | \$3,011 | \$3,162 | \$6,551 | \$7,206 | \$7,962 | \$8,759 |
| 65T54162AR_ | 162 | 54 | 2 | \$1,964 | \$2,637 | \$2,769 | \$3,592 | \$3,771 | \$7,192 | \$7,911 | \$8,922 | \$9,814 |
| 65T60162AR_ | 162 | 60 | 2 | \$2,138 | \$2,664 | \$2,797 | \$3,629 | \$3,810 | \$8,189 | \$9,008 | \$9,953 | \$10,948 |
| 65T48168AR_ | 168 | 48 | 2 | \$1,848 | \$2,270 | \$2,383 | \$3,083 | \$3,237 | \$6,794 | \$7,473 | \$8,255 | \$9,080 |
| 65T54168AR_ | 168 | 54 | 2 | \$2,027 | \$2,641 | \$2,773 | \$3,599 | \$3,780 | \$7,605 | \$8,365 | \$9,292 | \$10,221 |
| 65T60168AR_ | 168 | 60 | 2 | \$2,207 | \$2,669 | \$2,802 | \$3,636 | \$3,819 | \$8,492 | \$9,341 | \$10,323 | \$11,356 |
| 65T48174AR_ | 174 | 48 | 2 | \$2,207 | \$2,274 | \$2,387 | \$3,089 | \$3,244 | \$7,035 | \$7,739 | \$8,553 | \$9,409 |
| 65T54174AR_ | 174 | 54 | 2 | \$2,089 | \$2,643 | \$2,776 | \$3,604 | \$3,785 | \$7,868 | \$8,655 | \$9,587 | \$10,545 |
| 65T60174AR_ | 174 | 60 | 2 | \$2,276 | \$2,671 | \$2,805 | \$3,642 | \$3,824 | \$8,795 | \$9,674 | \$10,690 | \$11,758 |
| 65T48180AR_ | 180 | 48 | 2 | \$1,961 | \$2,277 | \$2,390 | \$3,095 | \$3,249 | \$7,278 | \$8,007 | \$8,850 | \$9,735 |
| 65T54180AR_ | 180 | 54 | 2 | \$2,151 | \$2,652 | \$2,785 | \$3,613 | \$3,793 | \$8,130 | \$8,944 | \$9,880 | \$10,868 |
| 65T60180AR_ | 180 | 60 | 2 | \$2,345 | \$2,680 | \$2,813 | \$3,650 | \$3,832 | \$9,098 | \$10,008 | \$11,057 | \$12,162 |
| 65T48186AR_ | 186 | 48 | 2 | \$2,018 | \$2,281 | \$2,395 | \$3,102 | \$3,257 | \$7,522 | \$8,273 | \$9,144 | \$10,058 |
| 65T54186AR_ | 186 | 54 | 2 | \$2,215 | \$2,657 | \$2,789 | \$3,618 | \$3,798 | \$8,377 | \$9,216 | \$10,247 | \$11,272 |
| 65T60186AR_ | 186 | 60 | 2 | \$2,414 | \$2,683 | \$2,818 | \$3,655 | \$3,837 | \$9,401 | \$10,342 | \$11,427 | \$12,570 |
| 65T48192AR_ | 192 | 48 | 2 | \$2,075 | \$2,286 | \$2,400 | \$3,108 | \$3,264 | \$7,764 | \$8,540 | \$9,437 | \$10,382 |
| 65T54192AR_ | 192 | 54 | 2 | \$2,279 | \$2,661 | \$2,794 | \$3,623 | \$3,804 | \$8,627 | \$9,490 | \$10,615 | \$11,676 |
| 65T60192AR_ | 192 | 60 | 2 | \$2,484 | \$2,687 | \$2,822 | \$3,661 | \$3,844 | \$9,705 | \$10,675 | \$11,797 | \$12,976 |
| 65T48198AR_ | 198 | 48 | 3 | \$2,150 | \$3,182 | \$3,342 | \$4,296 | \$4,510 | \$8,863 | \$9,748 | \$10,719 | \$11,790 |
| 65T54198AR_ | 198 | 54 | 3 | \$2,360 | \$3,623 | \$3,804 | \$4,934 | \$5,180 | \$9,862 | \$10,848 | \$11,867 | \$13,054 |
| 65T60198AR_ | 198 | 60 | 3 | \$2,572 | \$3,661 | \$3,844 | \$4,984 | \$5,233 | \$11,069 | \$12,176 | \$13,321 | \$14,653 |
| 65T48204AR_ | 204 | 48 | 3 | \$2,224 | \$3,226 | \$3,387 | \$4,379 | \$4,598 | \$9,122 | \$10,035 | \$10,978 | \$12,076 |
| 65T54204AR_ | 204 | 54 | 3 | \$2,443 | \$3,631 | \$3,813 | \$4,940 | \$5,188 | \$10,196 | \$11,216 | \$12,270 | \$13,498 |
| 65T60204AR_ | 204 | 60 | 3 | \$2,662 | \$3,669 | \$3,853 | \$4,992 | \$5,241 | \$11,403 | \$12,543 | \$13,726 | \$15,098 |
| 65T48210AR_ | 210 | 48 | 3 | \$2,300 | \$3,231 | \$3,392 | \$4,387 | \$4,606 | \$9,389 | \$10,327 | \$11,300 | \$12,430 |
| 65T54210AR_ | 210 | 54 | 3 | \$2,524 | \$3,635 | \$3,818 | \$4,947 | \$5,194 | \$10,529 | \$11,582 | \$12,674 | \$13,941 |
| 65T60210AR_ | 210 | 60 | 3 | \$2,751 | \$3,672 | \$3,857 | \$4,998 | \$5,247 | \$11,736 | \$12,911 | \$14,129 | \$15,542 |

| Model | TFL Top Surface | HPL Top Surface | Top Profile | Veneer Top Material | Top Surface Power Cutout |
|-------|--|--|--|--|--|
| | see Anthology TFL Top Surface Finishes | see Anthology HPL Top Surface Finishes | see Anthology Top Profile Finishes (when applicable) | see Anthology Veneer Top Material Finishes | see Anthology Top Surface Power Cutout |

Arc Rectangular Table Tops (continued)

- planning top specification [ANPG_6](#)
- base guide [pages 38-57](#)
- planning power guide [ANPG_20- ANPG_40](#)

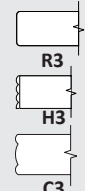
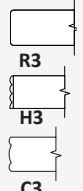
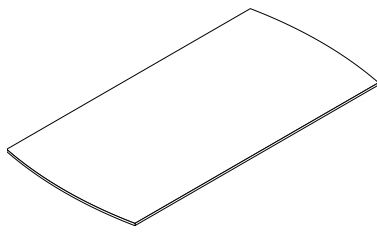

| ① Model | W | D | Top Pieces | R3 TFL | R3 HPL Tier 1 H | R3 HPL Tier 2 H | K9 HPL Tier 1 KH | K9 HPL Tier 2 KH | R3 H3 C3 ESS Veneer V | R3 H3 C3 ART Veneer V | K9 ESS Veneer KV | K9 ART Veneer KV |
|-------------|-----|----|------------|---------|-----------------|-----------------|------------------|------------------|-----------------------|-----------------------|------------------|------------------|
| 65T48216AR_ | 216 | 48 | 3 | \$2,375 | \$3,235 | \$3,396 | \$4,394 | \$4,614 | \$9,657 | \$10,622 | \$11,621 | \$12,783 |
| 65T54216AR_ | 216 | 54 | 3 | \$2,605 | \$3,639 | \$3,822 | \$4,953 | \$5,200 | \$10,864 | \$11,950 | \$13,076 | \$14,384 |
| 65T60216AR_ | 216 | 60 | 3 | \$2,840 | \$3,677 | \$3,861 | \$5,003 | \$5,253 | \$12,070 | \$13,277 | \$14,532 | \$15,985 |
| 65T48222AR_ | 222 | 48 | 3 | \$2,450 | \$3,239 | \$3,401 | \$4,400 | \$4,619 | \$9,926 | \$10,918 | \$11,945 | \$13,140 |
| 65T54222AR_ | 222 | 54 | 3 | \$2,687 | \$3,696 | \$3,881 | \$5,031 | \$5,282 | \$11,133 | \$12,246 | \$13,401 | \$14,741 |
| 65T60222AR_ | 222 | 60 | 3 | \$2,929 | \$3,734 | \$3,921 | \$5,083 | \$5,337 | \$12,407 | \$13,648 | \$14,935 | \$16,429 |
| 65T48228AR_ | 228 | 48 | 3 | \$2,525 | \$3,243 | \$3,406 | \$4,406 | \$4,626 | \$10,196 | \$11,216 | \$12,270 | \$13,498 |
| 65T54228AR_ | 228 | 54 | 3 | \$2,769 | \$3,753 | \$3,940 | \$5,108 | \$5,364 | \$11,403 | \$12,543 | \$13,726 | \$15,098 |
| 65T60228AR_ | 228 | 60 | 3 | \$3,018 | \$3,792 | \$3,981 | \$5,161 | \$5,419 | \$12,744 | \$14,018 | \$15,338 | \$16,872 |
| 65T48234AR_ | 234 | 48 | 3 | \$2,600 | \$3,370 | \$3,538 | \$4,471 | \$4,694 | \$10,462 | \$11,509 | \$12,592 | \$13,851 |
| 65T54234AR_ | 234 | 54 | 3 | \$2,851 | \$3,758 | \$3,945 | \$5,114 | \$5,370 | \$11,736 | \$12,911 | \$14,129 | \$15,542 |
| 65T60234AR_ | 234 | 60 | 3 | \$3,107 | \$3,797 | \$3,987 | \$5,168 | \$5,426 | \$13,076 | \$14,384 | \$15,742 | \$17,316 |
| 65T48240AR_ | 240 | 48 | 3 | \$2,675 | \$3,496 | \$3,671 | \$4,536 | \$4,762 | \$10,730 | \$11,803 | \$12,914 | \$14,204 |
| 65T54240AR_ | 240 | 54 | 3 | \$2,935 | \$3,763 | \$3,951 | \$5,122 | \$5,378 | \$12,070 | \$13,277 | \$14,532 | \$15,985 |
| 65T60240AR_ | 240 | 60 | 3 | \$3,197 | \$3,802 | \$3,993 | \$5,174 | \$5,433 | \$13,411 | \$14,752 | \$16,146 | \$17,760 |

| Model | TFL Top Surface | HPL Top Surface | Top Profile | Veneer Top Material | Top Surface Power Cutout |
|-------|--|--|--|--|--|
| | see Anthology TFL Top Surface Finishes | see Anthology HPL Top Surface Finishes | see Anthology Top Profile Finishes (when applicable) | see Anthology Veneer Top Material Finishes | see Anthology Top Surface Power Cutout |

Boat Table Tops

- ends are 6" narrower than overall center dimension
- planning top specification [ANPG_6](#)
- base guide [pages 38-57](#)
- planning power guide [ANPG_20- ANPG_40](#)

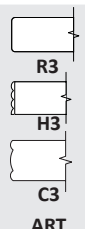
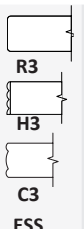
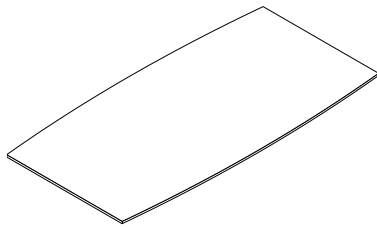

| Model | W | D | Top Pieces | TFL T | HPL Tier 1 H | HPL Tier 2 H | HPL Tier 1 KH | HPL Tier 2 KH | ESS Veneer V | ART Veneer V | ESS Veneer KV | ART Veneer KV |
|--------------|-----|----|------------|----------|-----------------|-----------------|------------------|------------------|-----------------|-----------------|------------------|------------------|
| 65T3672BT_ | 72 | 36 | 1 | \$506 | \$827 | \$868 | \$1,208 | \$1,267 | \$2,186 | \$2,405 | \$2,566 | \$2,823 |
| 65T4272BT_ | 72 | 42 | 1 | \$608 | \$887 | \$932 | \$1,292 | \$1,357 | \$2,427 | \$2,670 | \$2,991 | \$3,289 |
| 65T4872BT_ | 72 | 48 | 1 | \$696 | \$892 | \$937 | \$1,296 | \$1,361 | \$2,707 | \$2,978 | \$3,249 | \$3,575 |
| 65T3678BT_ | 78 | 36 | 1 | \$568 | \$945 | \$992 | \$1,238 | \$1,300 | \$2,349 | \$2,584 | \$2,778 | \$3,057 |
| 65T4278BT_ | 78 | 42 | 1 | \$669 | \$981 | \$1,030 | \$1,341 | \$1,407 | \$2,606 | \$2,867 | \$3,131 | \$3,444 |
| 65T4878BT_ | 78 | 48 | 1 | \$758 | \$985 | \$1,035 | \$1,346 | \$1,413 | \$2,907 | \$3,198 | \$3,471 | \$3,817 |
| 65T3684BT_ | 84 | 36 | 1 | \$629 | \$964 | \$1,011 | \$1,256 | \$1,319 | \$2,500 | \$2,751 | \$2,991 | \$3,289 |
| 65T4284BT_ | 84 | 42 | 1 | \$731 | \$1,008 | \$1,058 | \$1,355 | \$1,422 | \$2,777 | \$3,055 | \$3,415 | \$3,756 |
| 65T4884BT_ | 84 | 48 | 1 | \$819 | \$1,012 | \$1,062 | \$1,360 | \$1,428 | \$3,101 | \$3,411 | \$3,755 | \$4,130 |
| 65T3690BT_ | 90 | 36 | 1 | \$691 | \$980 | \$1,029 | \$1,273 | \$1,336 | \$2,657 | \$2,922 | \$3,203 | \$3,523 |
| 65T4290BT_ | 90 | 42 | 1 | \$793 | \$1,035 | \$1,086 | \$1,364 | \$1,432 | \$2,950 | \$3,245 | \$3,700 | \$4,070 |
| 65T4890BT_ | 90 | 48 | 1 | \$880 | \$1,039 | \$1,090 | \$1,368 | \$1,437 | \$3,298 | \$3,627 | \$4,006 | \$4,407 |
| 65T3696BT_ | 96 | 36 | 1 | \$752 | \$998 | \$1,047 | \$1,290 | \$1,355 | \$2,810 | \$3,092 | \$3,415 | \$3,756 |
| 65T4296BT_ | 96 | 42 | 1 | \$854 | \$1,061 | \$1,115 | \$1,372 | \$1,441 | \$3,120 | \$3,432 | \$3,986 | \$4,384 |
| 65T4896BT_ | 96 | 48 | 1 | \$942 | \$1,067 | \$1,119 | \$1,377 | \$1,446 | \$3,450 | \$3,795 | \$4,259 | \$4,684 |
| 65T42102BT1_ | 102 | 42 | 1 | \$886 | \$1,559 | \$1,636 | \$2,120 | \$2,226 | \$3,570 | \$3,928 | \$4,012 | \$4,413 |
| 65T48102BT1_ | 102 | 48 | 1 | \$953 | \$1,567 | \$1,645 | \$2,145 | \$2,252 | \$3,901 | \$4,290 | \$4,694 | \$5,164 |
| 65T42102BT2_ | 102 | 42 | 2 | \$1,098 | \$1,676 | \$1,760 | \$2,281 | \$2,395 | \$3,840 | \$4,225 | \$4,313 | \$4,745 |
| 65T48102BT2_ | 102 | 48 | 2 | \$1,210 | \$1,685 | \$1,769 | \$2,307 | \$2,422 | \$4,195 | \$4,614 | \$5,047 | \$5,552 |
| 65T42108BT1_ | 108 | 42 | 1 | \$934 | \$1,583 | \$1,662 | \$2,125 | \$2,231 | \$3,732 | \$4,105 | \$4,254 | \$4,680 |
| 65T48108BT1_ | 108 | 48 | 1 | \$1,015 | \$1,590 | \$1,670 | \$2,170 | \$2,278 | \$4,062 | \$4,469 | \$4,936 | \$5,430 |
| 65T42108BT2_ | 108 | 42 | 2 | \$1,153 | \$1,702 | \$1,787 | \$2,285 | \$2,399 | \$4,013 | \$4,415 | \$4,574 | \$5,031 |
| 65T48108BT2_ | 108 | 48 | 2 | \$1,270 | \$1,710 | \$1,796 | \$2,332 | \$2,450 | \$4,368 | \$4,804 | \$5,308 | \$5,839 |
| 65T42114BT1_ | 114 | 42 | 1 | \$981 | \$1,607 | \$1,688 | \$2,150 | \$2,257 | \$3,913 | \$4,305 | \$4,528 | \$4,981 |
| 65T48114BT1_ | 114 | 48 | 1 | \$1,077 | \$1,615 | \$1,695 | \$2,194 | \$2,304 | \$4,288 | \$4,717 | \$5,209 | \$5,729 |
| 65T42114BT2_ | 114 | 42 | 2 | \$1,209 | \$1,728 | \$1,814 | \$2,311 | \$2,426 | \$4,208 | \$4,629 | \$4,868 | \$5,355 |
| 65T48114BT2_ | 114 | 48 | 2 | \$1,332 | \$1,737 | \$1,824 | \$2,358 | \$2,477 | \$4,611 | \$5,071 | \$5,602 | \$6,162 |

| Model | TFL Top Surface | HPL Top Surface | Top Profile | Veneer Top Material | Top Surface Power Cutout |
|-------|--|--|--|--|--|
| | see Anthology TFL Top Surface Finishes | see Anthology HPL Top Surface Finishes | see Anthology Top Profile Finishes (when applicable) | see Anthology Veneer Top Material Finishes | see Anthology Top Surface Power Cutout |

Boat Table Tops (continued)

- ends are 6" narrower than overall center dimension
- planning top specification [ANPG_6](#)
- base guide [pages 38-57](#)
- planning power guide [ANPG_20- ANPG_40](#)

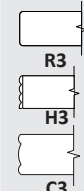
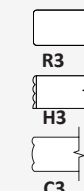
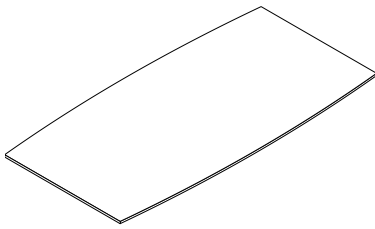

| Model | W | D | Top Pieces | TFL R3 T | HPL Tier 1 R3 H | HPL Tier 2 R3 H | HPL Tier 1 K9 KH | HPL Tier 2 K9 KH | ESS Veneer R3 H3 C3 V | ART Veneer R3 H3 C3 V | ESS Veneer K9 KV | ART Veneer K9 KV |
|--------------|-----|----|------------|----------------|-----------------------|-----------------------|------------------------|------------------------|-----------------------------------|-----------------------------------|------------------------|------------------------|
| 65T42120BT1_ | 120 | 42 | 1 | \$1,029 | \$1,631 | \$1,712 | \$2,173 | \$2,282 | \$4,096 | \$4,506 | \$4,800 | \$5,280 |
| 65T48120BT1_ | 120 | 48 | 1 | \$1,139 | \$1,639 | \$1,721 | \$2,217 | \$2,328 | \$4,513 | \$4,964 | \$5,484 | \$6,032 |
| 65T54120BT1_ | 120 | 54 | 1 | \$1,247 | \$1,842 | \$1,934 | \$2,498 | \$2,623 | \$4,975 | \$5,473 | \$6,010 | \$6,611 |
| 65T60120BT1_ | 120 | 60 | 1 | \$1,355 | \$1,861 | \$1,953 | \$2,524 | \$2,650 | \$5,642 | \$6,206 | \$6,859 | \$7,545 |
| 65T42120BT2_ | 120 | 42 | 2 | \$1,263 | \$1,754 | \$1,841 | \$2,337 | \$2,453 | \$4,404 | \$4,844 | \$5,162 | \$5,679 |
| 65T48120BT2_ | 120 | 48 | 2 | \$1,394 | \$1,762 | \$1,850 | \$2,385 | \$2,504 | \$4,853 | \$5,338 | \$5,896 | \$6,486 |
| 65T54120BT2_ | 120 | 54 | 2 | \$1,525 | \$1,980 | \$2,080 | \$2,686 | \$2,821 | \$5,350 | \$5,885 | \$6,462 | \$7,107 |
| 65T60120BT2_ | 120 | 60 | 2 | \$1,655 | \$2,001 | \$2,101 | \$2,714 | \$2,849 | \$6,066 | \$6,673 | \$7,375 | \$8,113 |
| 65T48126BT_ | 126 | 48 | 2 | \$1,452 | \$1,804 | \$1,895 | \$2,487 | \$2,611 | \$5,096 | \$5,605 | \$6,194 | \$6,813 |
| 65T54126BT_ | 126 | 54 | 2 | \$1,585 | \$2,089 | \$2,193 | \$2,949 | \$3,097 | \$5,590 | \$6,149 | \$6,753 | \$7,429 |
| 65T60126BT_ | 126 | 60 | 2 | \$1,724 | \$2,111 | \$2,217 | \$2,980 | \$3,129 | \$6,370 | \$7,007 | \$7,742 | \$8,517 |
| 65T48132BT_ | 132 | 48 | 2 | \$1,508 | \$1,847 | \$1,939 | \$2,589 | \$2,718 | \$5,338 | \$5,873 | \$6,491 | \$7,139 |
| 65T54132BT_ | 132 | 54 | 2 | \$1,648 | \$2,199 | \$2,308 | \$3,213 | \$3,374 | \$5,828 | \$6,411 | \$7,046 | \$7,750 |
| 65T60132BT_ | 132 | 60 | 2 | \$1,793 | \$2,220 | \$2,331 | \$3,246 | \$3,409 | \$6,672 | \$7,339 | \$8,110 | \$8,920 |
| 65T48138BT_ | 138 | 48 | 2 | \$1,565 | \$1,890 | \$1,984 | \$2,692 | \$2,826 | \$5,580 | \$6,138 | \$6,785 | \$7,464 |
| 65T54138BT_ | 138 | 54 | 2 | \$1,712 | \$2,203 | \$2,313 | \$3,220 | \$3,381 | \$6,068 | \$6,675 | \$7,505 | \$8,255 |
| 65T60138BT_ | 138 | 60 | 2 | \$1,862 | \$2,224 | \$2,336 | \$3,252 | \$3,415 | \$6,976 | \$7,673 | \$8,479 | \$9,327 |
| 65T48144BT_ | 144 | 48 | 2 | \$1,621 | \$1,931 | \$2,028 | \$2,792 | \$2,932 | \$5,823 | \$6,405 | \$7,079 | \$7,786 |
| 65T54144BT_ | 144 | 54 | 2 | \$1,776 | \$2,208 | \$2,318 | \$3,225 | \$3,386 | \$6,306 | \$6,937 | \$7,964 | \$8,761 |
| 65T60144BT_ | 144 | 60 | 2 | \$1,931 | \$2,230 | \$2,342 | \$3,258 | \$3,421 | \$7,278 | \$8,007 | \$8,850 | \$9,735 |
| 65T48150BT_ | 150 | 48 | 2 | \$1,678 | \$2,016 | \$2,117 | \$2,865 | \$3,009 | \$6,066 | \$6,673 | \$7,373 | \$8,111 |
| 65T54150BT_ | 150 | 54 | 2 | \$1,838 | \$2,420 | \$2,540 | \$3,414 | \$3,585 | \$6,544 | \$7,198 | \$8,258 | \$9,084 |
| 65T60150BT_ | 150 | 60 | 2 | \$2,000 | \$2,446 | \$2,567 | \$3,441 | \$3,613 | \$7,582 | \$8,340 | \$9,216 | \$10,138 |
| 65T48156BT_ | 156 | 48 | 2 | \$1,735 | \$2,105 | \$2,210 | \$2,939 | \$3,085 | \$6,308 | \$6,939 | \$7,667 | \$8,434 |
| 65T54156BT_ | 156 | 54 | 2 | \$1,901 | \$2,634 | \$2,766 | \$3,587 | \$3,766 | \$6,780 | \$7,458 | \$8,553 | \$9,409 |
| 65T60156BT_ | 156 | 60 | 2 | \$2,069 | \$2,661 | \$2,794 | \$3,623 | \$3,804 | \$7,885 | \$8,674 | \$9,583 | \$10,542 |

| Model | TFL Top Surface | HPL Top Surface | Top Profile | Veneer Top Material | Top Surface Power Cutout |
|-------|--|--|--|--|--|
| | see Anthology TFL Top Surface Finishes | see Anthology HPL Top Surface Finishes | see Anthology Top Profile Finishes (when applicable) | see Anthology Veneer Top Material Finishes | see Anthology Top Surface Power Cutout |

Boat Table Tops (continued)

- ends are 6" narrower than overall center dimension
- planning top specification [ANPG_6](#)
- base guide [pages 38-57](#)
- planning power guide [ANPG_20- ANPG_40](#)

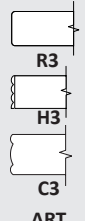
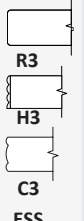
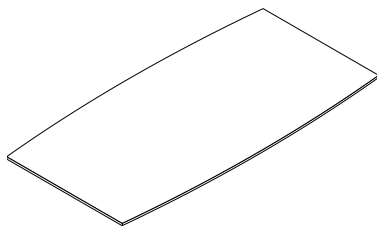

| Model | W | D | Top Pieces | TFL T | HPL Tier 1 H | HPL Tier 2 H | HPL Tier 1 KH | HPL Tier 2 KH | ESS Veneer V | ART Veneer V | ESS Veneer KV | ART Veneer KV |
|-------------|-----|----|------------|----------|-----------------|-----------------|------------------|------------------|-----------------|-----------------|------------------|------------------|
| 65T48162BT_ | 162 | 48 | 2 | \$1,792 | \$2,185 | \$2,294 | \$3,011 | \$3,162 | \$6,551 | \$7,206 | \$7,962 | \$8,759 |
| 65T54162BT_ | 162 | 54 | 2 | \$1,964 | \$2,637 | \$2,769 | \$3,592 | \$3,771 | \$7,192 | \$7,911 | \$8,922 | \$9,814 |
| 65T60162BT_ | 162 | 60 | 2 | \$2,138 | \$2,664 | \$2,797 | \$3,629 | \$3,810 | \$8,189 | \$9,008 | \$9,953 | \$10,948 |
| 65T48168BT_ | 168 | 48 | 2 | \$1,848 | \$2,270 | \$2,383 | \$3,083 | \$3,237 | \$6,794 | \$7,473 | \$8,255 | \$9,080 |
| 65T54168BT_ | 168 | 54 | 2 | \$2,027 | \$2,641 | \$2,773 | \$3,599 | \$3,780 | \$7,605 | \$8,365 | \$9,292 | \$10,221 |
| 65T60168BT_ | 168 | 60 | 2 | \$2,207 | \$2,669 | \$2,802 | \$3,636 | \$3,819 | \$8,492 | \$9,341 | \$10,323 | \$11,356 |
| 65T48174BT_ | 174 | 48 | 2 | \$1,904 | \$2,274 | \$2,387 | \$3,089 | \$3,244 | \$7,035 | \$7,739 | \$8,553 | \$9,409 |
| 65T54174BT_ | 174 | 54 | 2 | \$2,089 | \$2,643 | \$2,776 | \$3,604 | \$3,785 | \$7,868 | \$8,655 | \$9,587 | \$10,545 |
| 65T60174BT_ | 174 | 60 | 2 | \$2,276 | \$2,671 | \$2,805 | \$3,642 | \$3,824 | \$8,795 | \$9,674 | \$10,690 | \$11,758 |
| 65T48180BT_ | 180 | 48 | 2 | \$1,961 | \$2,277 | \$2,390 | \$3,095 | \$3,249 | \$7,278 | \$8,007 | \$8,850 | \$9,735 |
| 65T54180BT_ | 180 | 54 | 2 | \$2,151 | \$2,652 | \$2,785 | \$3,613 | \$3,793 | \$8,130 | \$8,944 | \$9,880 | \$10,868 |
| 65T60180BT_ | 180 | 60 | 2 | \$2,345 | \$2,680 | \$2,813 | \$3,650 | \$3,832 | \$9,098 | \$10,008 | \$11,057 | \$12,162 |
| 65T48186BT_ | 186 | 48 | 2 | \$2,018 | \$2,281 | \$2,395 | \$3,102 | \$3,257 | \$7,522 | \$8,273 | \$9,144 | \$10,058 |
| 65T54186BT_ | 186 | 54 | 2 | \$2,215 | \$2,657 | \$2,789 | \$3,618 | \$3,798 | \$8,377 | \$9,216 | \$10,247 | \$11,272 |
| 65T60186BT_ | 186 | 60 | 2 | \$2,414 | \$2,683 | \$2,818 | \$3,655 | \$3,837 | \$9,401 | \$10,342 | \$11,427 | \$12,570 |
| 65T48192BT_ | 192 | 48 | 2 | \$2,075 | \$2,286 | \$2,400 | \$3,108 | \$3,264 | \$7,764 | \$8,540 | \$9,437 | \$10,382 |
| 65T54192BT_ | 192 | 54 | 2 | \$2,279 | \$2,661 | \$2,794 | \$3,623 | \$3,804 | \$8,627 | \$9,490 | \$10,615 | \$11,676 |
| 65T60192BT_ | 192 | 60 | 2 | \$2,484 | \$2,687 | \$2,822 | \$3,661 | \$3,844 | \$9,705 | \$10,675 | \$11,797 | \$12,976 |
| 65T48198BT_ | 198 | 48 | 2 | \$2,150 | \$3,182 | \$3,342 | \$4,296 | \$4,510 | \$8,863 | \$9,748 | \$10,719 | \$11,790 |
| 65T54198BT_ | 198 | 54 | 2 | \$2,360 | \$3,623 | \$3,804 | \$4,934 | \$5,180 | \$9,862 | \$10,848 | \$11,867 | \$13,054 |
| 65T60198BT_ | 198 | 60 | 2 | \$2,572 | \$3,661 | \$3,844 | \$4,984 | \$5,233 | \$11,069 | \$12,176 | \$13,321 | \$14,653 |
| 65T48204BT_ | 204 | 48 | 3 | \$2,224 | \$3,226 | \$3,387 | \$4,379 | \$4,598 | \$9,122 | \$10,035 | \$10,978 | \$12,076 |
| 65T54204BT_ | 204 | 54 | 3 | \$2,443 | \$3,631 | \$3,813 | \$4,940 | \$5,188 | \$10,196 | \$11,216 | \$12,270 | \$13,498 |
| 65T60204BT_ | 204 | 60 | 3 | \$2,662 | \$3,669 | \$3,853 | \$4,992 | \$5,241 | \$11,403 | \$12,543 | \$13,726 | \$15,098 |
| 65T48210BT_ | 210 | 48 | 3 | \$2,300 | \$3,231 | \$3,392 | \$4,387 | \$4,606 | \$9,389 | \$10,327 | \$11,300 | \$12,430 |
| 65T54210BT_ | 210 | 54 | 3 | \$2,524 | \$3,635 | \$3,818 | \$4,947 | \$5,194 | \$10,529 | \$11,582 | \$12,674 | \$13,941 |
| 65T60210BT_ | 210 | 60 | 3 | \$2,751 | \$3,672 | \$3,857 | \$4,998 | \$5,247 | \$11,736 | \$12,911 | \$14,129 | \$15,542 |

| Model | TFL Top Surface | HPL Top Surface | Top Profile | Veneer Top Material | Top Surface Power Cutout |
|-------|--|--|--|--|--|
| | see Anthology TFL Top Surface Finishes | see Anthology HPL Top Surface Finishes | see Anthology Top Profile Finishes (when applicable) | see Anthology Veneer Top Material Finishes | see Anthology Top Surface Power Cutout |

Boat Table Tops (continued)

- ends are 6" narrower than overall center dimension
- planning top specification [ANPG_6](#)
- base guide [pages 38-57](#)
- planning power guide [ANPG_20- ANPG_40](#)

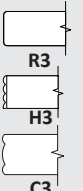
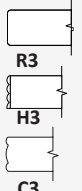
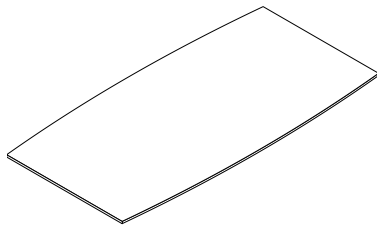

| ① Model | W | D | Top Pieces | R3 TFL | R3 HPL Tier 1 H | R3 HPL Tier 2 H | K9 HPL Tier 1 KH | K9 HPL Tier 2 KH | R3 H3 C3 ESS Veneer V | R3 H3 C3 ART Veneer V | K9 ESS Veneer KV | K9 ART Veneer KV |
|-------------|-----|----|------------|---------|-----------------|-----------------|------------------|------------------|-----------------------|-----------------------|------------------|------------------|
| 65T48216BT_ | 216 | 48 | 3 | \$2,375 | \$3,235 | \$3,396 | \$4,394 | \$4,614 | \$9,657 | \$10,622 | \$11,621 | \$12,783 |
| 65T54216BT_ | 216 | 54 | 3 | \$2,605 | \$3,639 | \$3,822 | \$4,953 | \$5,200 | \$10,864 | \$11,950 | \$13,076 | \$14,384 |
| 65T60216BT_ | 216 | 60 | 3 | \$2,840 | \$3,677 | \$3,861 | \$5,003 | \$5,253 | \$12,070 | \$13,277 | \$14,532 | \$15,985 |
| 65T48222BT_ | 222 | 48 | 3 | \$2,450 | \$3,239 | \$3,401 | \$4,400 | \$4,619 | \$9,926 | \$10,918 | \$11,945 | \$13,140 |
| 65T54222BT_ | 222 | 54 | 3 | \$2,687 | \$3,696 | \$3,881 | \$5,031 | \$5,282 | \$11,133 | \$12,246 | \$13,401 | \$14,741 |
| 65T60222BT_ | 222 | 60 | 3 | \$2,929 | \$3,734 | \$3,921 | \$5,083 | \$5,337 | \$12,407 | \$13,648 | \$14,935 | \$16,429 |
| 65T48228BT_ | 228 | 48 | 3 | \$2,525 | \$3,243 | \$3,406 | \$4,406 | \$4,626 | \$10,196 | \$11,216 | \$12,270 | \$13,498 |
| 65T54228BT_ | 228 | 54 | 3 | \$2,769 | \$3,753 | \$3,940 | \$5,108 | \$5,364 | \$11,403 | \$12,543 | \$13,726 | \$15,098 |
| 65T60228BT_ | 228 | 60 | 3 | \$3,018 | \$3,792 | \$3,981 | \$5,161 | \$5,419 | \$12,744 | \$14,018 | \$15,338 | \$16,872 |
| 65T48234BT_ | 234 | 48 | 3 | \$2,600 | \$3,370 | \$3,538 | \$4,471 | \$4,694 | \$10,462 | \$11,509 | \$12,592 | \$13,851 |
| 65T54234BT_ | 234 | 54 | 3 | \$2,851 | \$3,758 | \$3,945 | \$5,114 | \$5,370 | \$11,736 | \$12,911 | \$14,129 | \$15,542 |
| 65T60234BT_ | 234 | 60 | 3 | \$3,107 | \$3,797 | \$3,987 | \$5,168 | \$5,426 | \$13,076 | \$14,384 | \$15,742 | \$17,316 |
| 65T48240BT_ | 240 | 48 | 3 | \$2,675 | \$3,496 | \$3,671 | \$4,536 | \$4,762 | \$10,730 | \$11,803 | \$12,914 | \$14,204 |
| 65T54240BT_ | 240 | 54 | 3 | \$2,935 | \$3,763 | \$3,951 | \$5,122 | \$5,378 | \$12,070 | \$13,277 | \$14,532 | \$15,985 |
| 65T60240BT_ | 240 | 60 | 3 | \$3,197 | \$3,802 | \$3,993 | \$5,174 | \$5,433 | \$13,411 | \$14,752 | \$16,146 | \$17,760 |

| Model | TFL Top Surface | HPL Top Surface | Top Profile | Veneer Top Material | Top Surface Power Cutout |
|-------|--|--|--|--|--|
| | see Anthology TFL Top Surface Finishes | see Anthology HPL Top Surface Finishes | see Anthology Top Profile Finishes (when applicable) | see Anthology Veneer Top Material Finishes | see Anthology Top Surface Power Cutout |

Arc Boat Table Tops

- ends are 6" narrower than overall center dimension with 8" radius corners
- planning top specification [ANPG_6](#)
- base guide [pages 38-57](#)
- planning power guide [ANPG_20- ANPG_40](#)

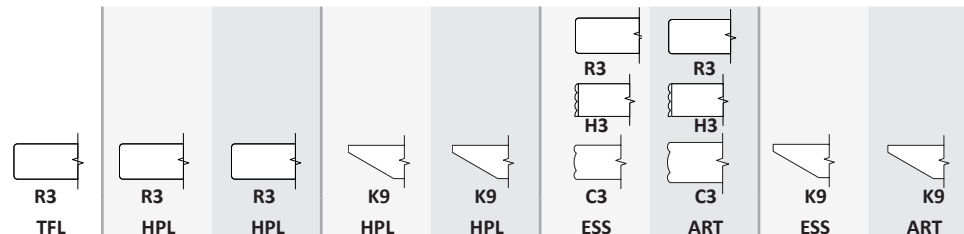
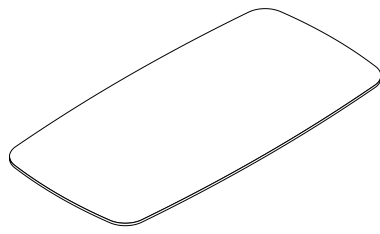

| Model | W | D | Top Pieces | R3 TFL T | R3 HPL Tier 1 H | R3 HPL Tier 2 H | K9 HPL Tier 1 KH | K9 HPL Tier 2 KH | ESS Veneer V | ART Veneer V | ESS Veneer KV | ART Veneer KV |
|--------------|-----|----|------------|----------|-----------------|-----------------|------------------|------------------|--------------|--------------|---------------|---------------|
| 65T3672AB_ | 72 | 36 | 1 | \$506 | \$827 | \$868 | \$1,208 | \$1,267 | \$2,186 | \$2,405 | \$2,566 | \$2,823 |
| 65T4272AB_ | 72 | 42 | 1 | \$608 | \$887 | \$932 | \$1,292 | \$1,357 | \$2,427 | \$2,670 | \$2,991 | \$3,289 |
| 65T4872AB_ | 72 | 48 | 1 | \$696 | \$892 | \$937 | \$1,296 | \$1,361 | \$2,707 | \$2,978 | \$3,249 | \$3,575 |
| 65T3678AB_ | 78 | 36 | 1 | \$568 | \$945 | \$992 | \$1,238 | \$1,300 | \$2,349 | \$2,584 | \$2,778 | \$3,057 |
| 65T4278AB_ | 78 | 42 | 1 | \$669 | \$981 | \$1,030 | \$1,341 | \$1,407 | \$2,606 | \$2,867 | \$3,131 | \$3,444 |
| 65T4878AB_ | 78 | 48 | 1 | \$758 | \$985 | \$1,035 | \$1,346 | \$1,413 | \$2,907 | \$3,198 | \$3,471 | \$3,817 |
| 65T3684AB_ | 84 | 36 | 1 | \$629 | \$964 | \$1,011 | \$1,256 | \$1,319 | \$2,500 | \$2,751 | \$2,991 | \$3,289 |
| 65T4284AB_ | 84 | 42 | 1 | \$731 | \$1,008 | \$1,058 | \$1,355 | \$1,422 | \$2,777 | \$3,055 | \$3,415 | \$3,756 |
| 65T4884AB_ | 84 | 48 | 1 | \$819 | \$1,012 | \$1,062 | \$1,360 | \$1,428 | \$3,101 | \$3,411 | \$3,755 | \$4,130 |
| 65T3690AB_ | 90 | 36 | 1 | \$691 | \$980 | \$1,029 | \$1,273 | \$1,336 | \$2,657 | \$2,922 | \$3,203 | \$3,523 |
| 65T4290AB_ | 90 | 42 | 1 | \$793 | \$1,035 | \$1,086 | \$1,364 | \$1,432 | \$2,950 | \$3,245 | \$3,700 | \$4,070 |
| 65T4890AB_ | 90 | 48 | 1 | \$880 | \$1,039 | \$1,090 | \$1,368 | \$1,437 | \$3,298 | \$3,627 | \$4,006 | \$4,407 |
| 65T3696AB_ | 96 | 36 | 1 | \$752 | \$998 | \$1,047 | \$1,290 | \$1,355 | \$2,810 | \$3,092 | \$3,415 | \$3,756 |
| 65T4296AB_ | 96 | 42 | 1 | \$854 | \$1,061 | \$1,115 | \$1,372 | \$1,441 | \$3,120 | \$3,432 | \$3,986 | \$4,384 |
| 65T4896AB_ | 96 | 48 | 1 | \$942 | \$1,067 | \$1,119 | \$1,377 | \$1,446 | \$3,450 | \$3,795 | \$4,259 | \$4,684 |
| 65T42102AB1_ | 102 | 42 | 1 | \$886 | \$1,559 | \$1,636 | \$2,120 | \$2,226 | \$3,570 | \$3,928 | \$4,012 | \$4,413 |
| 65T48102AB1_ | 102 | 48 | 1 | \$953 | \$1,567 | \$1,645 | \$2,145 | \$2,252 | \$3,901 | \$4,290 | \$4,694 | \$5,164 |
| 65T42102AB2_ | 102 | 42 | 2 | \$1,098 | \$1,676 | \$1,760 | \$2,281 | \$2,395 | \$3,840 | \$4,225 | \$4,313 | \$4,745 |
| 65T48102AB2_ | 102 | 48 | 2 | \$1,210 | \$1,685 | \$1,769 | \$2,307 | \$2,422 | \$4,195 | \$4,614 | \$5,047 | \$5,552 |
| 65T42108AB1_ | 108 | 42 | 1 | \$934 | \$1,583 | \$1,662 | \$2,125 | \$2,231 | \$3,732 | \$4,105 | \$4,254 | \$4,680 |
| 65T48108AB1_ | 108 | 48 | 1 | \$1,015 | \$1,583 | \$1,662 | \$2,170 | \$2,278 | \$4,062 | \$4,469 | \$4,936 | \$5,430 |
| 65T42108AB2_ | 108 | 42 | 2 | \$1,153 | \$1,702 | \$1,787 | \$2,285 | \$2,399 | \$4,013 | \$4,415 | \$4,574 | \$5,031 |
| 65T48108AB2_ | 108 | 48 | 2 | \$1,270 | \$1,710 | \$1,796 | \$2,332 | \$2,450 | \$4,368 | \$4,804 | \$5,308 | \$5,839 |
| 65T42114AB1_ | 114 | 42 | 1 | \$981 | \$1,607 | \$1,688 | \$2,150 | \$2,257 | \$3,913 | \$4,305 | \$4,528 | \$4,981 |
| 65T48114AB1_ | 114 | 48 | 1 | \$1,077 | \$1,615 | \$1,695 | \$2,194 | \$2,304 | \$4,288 | \$4,717 | \$5,209 | \$5,729 |
| 65T42114AB2_ | 114 | 42 | 2 | \$1,209 | \$1,728 | \$1,814 | \$2,311 | \$2,426 | \$4,208 | \$4,629 | \$4,868 | \$5,355 |
| 65T48114AB2_ | 114 | 48 | 2 | \$1,332 | \$1,737 | \$1,824 | \$2,358 | \$2,477 | \$4,611 | \$5,071 | \$5,602 | \$6,162 |

| Model | TFL Top Surface | HPL Top Surface | Top Profile | Veneer Top Material | Top Surface Power Cutout |
|-------|--|--|--|--|--|
| | see Anthology TFL Top Surface Finishes | see Anthology HPL Top Surface Finishes | see Anthology Top Profile Finishes (when applicable) | see Anthology Veneer Top Material Finishes | see Anthology Top Surface Power Cutout |

Arc Boat Table Tops (continued)

- ends are 6" narrower than overall center dimension with 8" radius corners
- planning top specification [ANPG_6](#)
- base guide [pages 38-57](#)
- planning power guide [ANPG_20- ANPG_40](#)

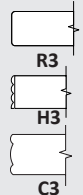
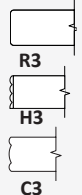
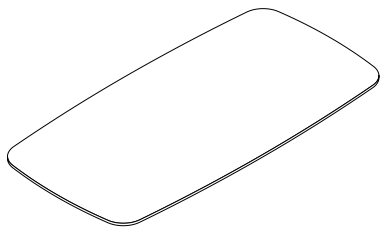

| Model | W | D | Top Pieces | TFL T | HPL Tier 1 H | HPL Tier 2 H | HPL Tier 1 KH | HPL Tier 2 KH | ESS Veneer V | ART Veneer V | ESS Veneer KV | ART Veneer KV |
|--------------|-----|----|------------|----------|-----------------|-----------------|------------------|------------------|-----------------|-----------------|------------------|------------------|
| 65T42120AB1_ | 120 | 42 | 1 | \$1,029 | \$1,631 | \$1,712 | \$2,173 | \$2,282 | \$4,096 | \$4,506 | \$4,800 | \$5,280 |
| 65T48120AB1_ | 120 | 48 | 1 | \$1,139 | \$1,639 | \$1,721 | \$2,217 | \$2,328 | \$4,513 | \$4,964 | \$5,484 | \$6,032 |
| 65T54120AB1_ | 120 | 54 | 1 | \$1,247 | \$1,842 | \$1,934 | \$2,498 | \$2,623 | \$4,975 | \$5,473 | \$6,010 | \$6,611 |
| 65T60120AB1_ | 120 | 60 | 1 | \$1,355 | \$1,861 | \$1,953 | \$2,524 | \$2,650 | \$5,642 | \$6,206 | \$6,859 | \$7,545 |
| 65T42120AB2_ | 120 | 42 | 2 | \$1,263 | \$1,754 | \$1,841 | \$2,337 | \$2,453 | \$4,404 | \$4,844 | \$5,162 | \$5,679 |
| 65T48120AB2_ | 120 | 48 | 2 | \$1,394 | \$1,762 | \$1,850 | \$2,385 | \$2,504 | \$4,853 | \$5,338 | \$5,896 | \$6,486 |
| 65T54120AB2_ | 120 | 54 | 2 | \$1,525 | \$1,980 | \$2,080 | \$2,686 | \$2,821 | \$5,350 | \$5,885 | \$6,462 | \$7,107 |
| 65T60120AB2_ | 120 | 60 | 2 | \$1,655 | \$2,001 | \$2,101 | \$2,714 | \$2,849 | \$6,066 | \$6,673 | \$7,375 | \$8,113 |
| 65T48126AB_ | 126 | 48 | 2 | \$1,452 | \$1,804 | \$1,895 | \$2,487 | \$2,611 | \$5,096 | \$5,605 | \$6,194 | \$6,813 |
| 65T54126AB_ | 126 | 54 | 2 | \$1,585 | \$2,089 | \$2,193 | \$2,949 | \$3,097 | \$5,590 | \$6,149 | \$6,753 | \$7,429 |
| 65T60126AB_ | 126 | 60 | 2 | \$1,724 | \$2,111 | \$2,217 | \$2,980 | \$3,129 | \$6,370 | \$7,007 | \$7,742 | \$8,517 |
| 65T48132AB_ | 132 | 48 | 2 | \$1,508 | \$1,847 | \$1,939 | \$2,589 | \$2,718 | \$5,338 | \$5,873 | \$6,491 | \$7,139 |
| 65T54132AB_ | 132 | 54 | 2 | \$1,648 | \$2,199 | \$2,308 | \$3,213 | \$3,374 | \$5,828 | \$6,411 | \$7,046 | \$7,750 |
| 65T60132AB_ | 132 | 60 | 2 | \$1,793 | \$2,220 | \$2,331 | \$3,246 | \$3,409 | \$6,672 | \$7,339 | \$8,110 | \$8,920 |
| 65T48138AB_ | 138 | 48 | 2 | \$1,565 | \$1,890 | \$1,984 | \$2,692 | \$2,826 | \$5,580 | \$6,138 | \$6,785 | \$7,464 |
| 65T54138AB_ | 138 | 48 | 2 | \$1,565 | \$1,890 | \$1,984 | \$2,692 | \$2,826 | \$5,580 | \$6,138 | \$6,785 | \$7,464 |
| 65T60138AB_ | 138 | 60 | 2 | \$1,862 | \$2,224 | \$2,336 | \$3,252 | \$3,415 | \$6,976 | \$7,673 | \$8,479 | \$9,327 |
| 65T48144AB_ | 144 | 48 | 2 | \$1,621 | \$1,931 | \$2,028 | \$2,792 | \$2,932 | \$5,823 | \$6,405 | \$7,079 | \$7,786 |
| 65T54144AB_ | 144 | 54 | 2 | \$1,776 | \$2,208 | \$2,318 | \$3,225 | \$3,386 | \$6,306 | \$6,937 | \$7,964 | \$8,761 |
| 65T60144AB_ | 144 | 60 | 2 | \$1,931 | \$2,230 | \$2,342 | \$3,258 | \$3,421 | \$7,278 | \$8,007 | \$8,850 | \$9,735 |
| 65T48150AB_ | 150 | 48 | 2 | \$1,678 | \$2,016 | \$2,117 | \$2,865 | \$3,009 | \$6,066 | \$6,673 | \$7,373 | \$8,111 |
| 65T54150AB_ | 150 | 54 | 2 | \$1,838 | \$2,420 | \$2,540 | \$3,414 | \$3,585 | \$6,544 | \$7,198 | \$8,258 | \$9,084 |
| 65T60150AB_ | 150 | 60 | 2 | \$2,000 | \$2,446 | \$2,567 | \$3,441 | \$3,613 | \$7,582 | \$8,340 | \$9,216 | \$10,138 |
| 65T48156AB_ | 156 | 48 | 2 | \$1,735 | \$2,105 | \$2,210 | \$2,939 | \$3,085 | \$6,308 | \$6,939 | \$7,667 | \$8,434 |
| 65T54156AB_ | 156 | 54 | 2 | \$1,901 | \$2,634 | \$2,766 | \$3,587 | \$3,766 | \$6,780 | \$7,458 | \$8,553 | \$9,409 |
| 65T60156AB_ | 156 | 60 | 2 | \$2,069 | \$2,661 | \$2,794 | \$3,623 | \$3,804 | \$7,885 | \$8,674 | \$9,583 | \$10,542 |

| Model | TFL Top Surface | HPL Top Surface | Top Profile | Veneer Top Material | Top Surface Power Cutout |
|-------|--|--|--|--|--|
| | see Anthology TFL Top Surface Finishes | see Anthology HPL Top Surface Finishes | see Anthology Top Profile Finishes (when applicable) | see Anthology Veneer Top Material Finishes | see Anthology Top Surface Power Cutout |

Arc Boat Table Tops (continued)

- ends are 6" narrower than overall center dimension with 8" radius corners
- planning top specification [ANPG_6](#)
- base guide [pages 38-57](#)
- planning power guide [ANPG_20- ANPG_40](#)

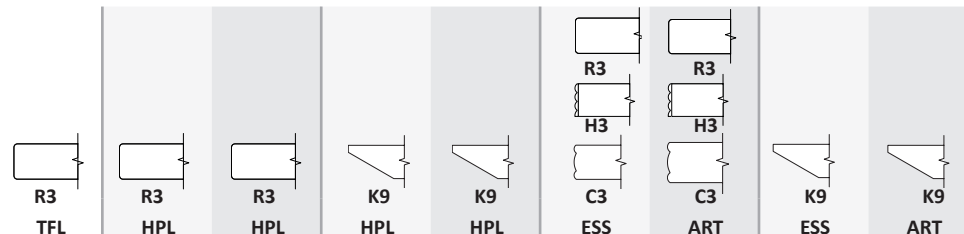
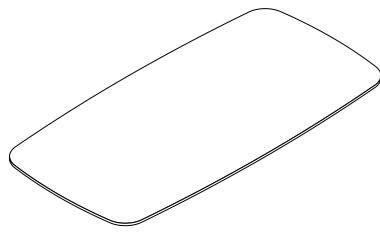

| ① Model | W | D | Top Pieces | R3 TFL T | R3 HPL Tier 1 H | R3 HPL Tier 2 H | K9 HPL Tier 1 KH | K9 HPL Tier 2 KH | ESS Veneer V | ART Veneer V | ESS Veneer KV | ART Veneer KV |
|-------------|-----|----|------------|-------------|--------------------|--------------------|---------------------|---------------------|-----------------|-----------------|------------------|------------------|
| 65T48162AB_ | 162 | 48 | 2 | \$1,792 | \$2,185 | \$2,294 | \$3,011 | \$3,162 | \$6,551 | \$7,206 | \$7,962 | \$8,759 |
| 65T54162AB_ | 162 | 54 | 2 | \$1,964 | \$2,637 | \$2,769 | \$3,592 | \$3,771 | \$7,192 | \$7,911 | \$8,922 | \$9,814 |
| 65T60162AB_ | 162 | 60 | 2 | \$2,138 | \$2,664 | \$2,797 | \$3,629 | \$3,810 | \$8,189 | \$9,008 | \$9,953 | \$10,948 |
| 65T48168AB_ | 168 | 48 | 2 | \$1,848 | \$2,270 | \$2,383 | \$3,083 | \$3,237 | \$6,794 | \$7,473 | \$8,255 | \$9,080 |
| 65T54168AB_ | 168 | 54 | 2 | \$2,027 | \$2,641 | \$2,773 | \$3,599 | \$3,780 | \$7,605 | \$8,365 | \$9,292 | \$10,221 |
| 65T60168AB_ | 168 | 60 | 2 | \$2,207 | \$2,669 | \$2,802 | \$3,636 | \$3,819 | \$8,492 | \$9,341 | \$10,323 | \$11,356 |
| 65T48174AB_ | 174 | 48 | 2 | \$1,904 | \$2,274 | \$2,387 | \$3,089 | \$3,244 | \$7,035 | \$7,739 | \$8,553 | \$9,409 |
| 65T54174AB_ | 174 | 54 | 2 | \$2,089 | \$2,643 | \$2,776 | \$3,604 | \$3,785 | \$7,868 | \$8,655 | \$9,587 | \$10,545 |
| 65T60174AB_ | 174 | 60 | 2 | \$2,276 | \$2,671 | \$2,805 | \$3,642 | \$3,824 | \$8,795 | \$9,674 | \$10,690 | \$11,758 |
| 65T48180AB_ | 180 | 48 | 2 | \$1,961 | \$2,277 | \$2,390 | \$3,095 | \$3,249 | \$7,278 | \$8,007 | \$8,850 | \$9,735 |
| 65T54180AB_ | 180 | 54 | 2 | \$2,151 | \$2,652 | \$2,785 | \$3,613 | \$3,793 | \$8,130 | \$8,944 | \$9,880 | \$10,868 |
| 65T60180AB_ | 180 | 60 | 2 | \$2,345 | \$2,680 | \$2,813 | \$3,650 | \$3,832 | \$9,098 | \$10,008 | \$11,057 | \$12,162 |
| 65T48186AB_ | 186 | 48 | 2 | \$2,018 | \$2,281 | \$2,395 | \$3,102 | \$3,257 | \$7,522 | \$8,273 | \$9,144 | \$10,058 |
| 65T54186AB_ | 186 | 54 | 2 | \$2,215 | \$2,657 | \$2,789 | \$3,618 | \$3,798 | \$8,377 | \$9,216 | \$10,247 | \$11,272 |
| 65T60186AB_ | 186 | 60 | 2 | \$2,414 | \$2,683 | \$2,818 | \$3,655 | \$3,837 | \$9,401 | \$10,342 | \$11,427 | \$12,570 |
| 65T48192AB_ | 192 | 48 | 2 | \$2,075 | \$2,286 | \$2,400 | \$3,108 | \$3,264 | \$7,764 | \$8,540 | \$9,437 | \$10,382 |
| 65T54192AB_ | 192 | 54 | 2 | \$2,279 | \$2,661 | \$2,794 | \$3,623 | \$3,804 | \$8,627 | \$9,490 | \$10,615 | \$11,676 |
| 65T60192AB_ | 192 | 60 | 2 | \$2,484 | \$2,687 | \$2,822 | \$3,661 | \$3,844 | \$9,705 | \$10,675 | \$11,797 | \$12,976 |
| 65T48198AB_ | 198 | 48 | 2 | \$2,150 | \$3,182 | \$3,342 | \$4,296 | \$4,510 | \$8,863 | \$9,748 | \$10,719 | \$11,790 |
| 65T54198AB_ | 198 | 54 | 2 | \$2,360 | \$3,623 | \$3,804 | \$4,934 | \$5,180 | \$9,862 | \$10,848 | \$11,867 | \$13,054 |
| 65T60198AB_ | 198 | 60 | 2 | \$2,572 | \$3,661 | \$3,844 | \$4,984 | \$5,233 | \$11,069 | \$12,176 | \$13,321 | \$14,653 |
| 65T48204AB_ | 204 | 48 | 3 | \$2,224 | \$3,226 | \$3,387 | \$4,379 | \$4,598 | \$9,122 | \$10,035 | \$10,978 | \$12,076 |
| 65T54204AB_ | 204 | 54 | 3 | \$2,443 | \$3,631 | \$3,813 | \$4,940 | \$5,188 | \$10,196 | \$11,216 | \$12,270 | \$13,498 |
| 65T60204AB_ | 204 | 60 | 3 | \$2,662 | \$3,669 | \$3,853 | \$4,992 | \$5,241 | \$11,403 | \$12,543 | \$13,726 | \$15,098 |
| 65T48210AB_ | 210 | 48 | 3 | \$2,300 | \$3,231 | \$3,392 | \$4,387 | \$4,606 | \$9,389 | \$10,327 | \$11,300 | \$12,430 |
| 65T54210AB_ | 210 | 54 | 3 | \$2,524 | \$3,635 | \$3,818 | \$4,947 | \$5,194 | \$10,529 | \$11,582 | \$12,674 | \$13,941 |
| 65T60210AB_ | 210 | 60 | 3 | \$2,751 | \$3,672 | \$3,857 | \$4,998 | \$5,247 | \$11,736 | \$12,911 | \$14,129 | \$15,542 |

| Model | TFL Top Surface | HPL Top Surface | Top Profile | Veneer Top Material | Top Surface Power Cutout |
|-------|--|--|---|--|--|
| | see Anthology TFL Top Surface Finishes | see Anthology HPL Top Surface Finishes | see Anthology Top Profile Finishes (when applicable) | see Anthology Veneer Top Material Finishes | see Anthology Top Surface Power Cutout |

Arc Boat Table Tops (continued)

- ends are 6" narrower than overall center dimension with 8" radius corners
- planning top specification [ANPG_6](#)
- base guide [pages 38-57](#)
- planning power guide [ANPG_20- ANPG_40](#)

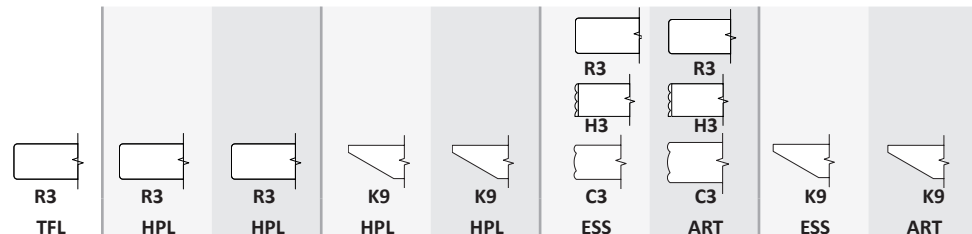
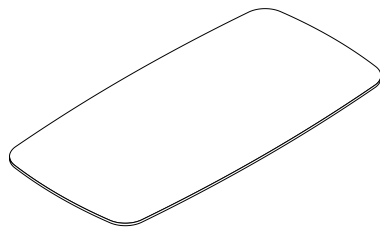

| ① Model | W | D | Top Pieces | R3 TFL T | R3 HPL Tier 1 H | R3 HPL Tier 2 H | K9 HPL Tier 1 KH | K9 HPL Tier 2 KH | R3 H3 C3 ESS Veneer V | R3 H3 C3 ART Veneer V | K9 ESS Veneer KV | K9 ART Veneer KV |
|-------------|-----|----|------------|-------------|--------------------|--------------------|---------------------|---------------------|-----------------------------|-----------------------------|------------------------|------------------------|
| 65T48216AB_ | 216 | 48 | 3 | \$2,375 | \$3,235 | \$3,396 | \$4,394 | \$4,614 | \$9,657 | \$10,622 | \$11,621 | \$12,783 |
| 65T54216AB_ | 216 | 54 | 3 | \$2,605 | \$3,639 | \$3,822 | \$4,953 | \$5,200 | \$10,864 | \$11,950 | \$13,076 | \$14,384 |
| 65T60216AB_ | 216 | 60 | 3 | \$2,840 | \$3,677 | \$3,861 | \$5,003 | \$5,253 | \$12,070 | \$13,277 | \$14,532 | \$15,985 |
| 65T48222AB_ | 222 | 48 | 3 | \$2,450 | \$3,239 | \$3,401 | \$4,400 | \$4,619 | \$9,926 | \$10,918 | \$11,945 | \$13,140 |
| 65T54222AB_ | 222 | 54 | 3 | \$2,687 | \$3,696 | \$3,881 | \$5,031 | \$5,282 | \$11,133 | \$12,246 | \$13,401 | \$14,741 |
| 65T60222AB_ | 222 | 60 | 3 | \$2,929 | \$3,734 | \$3,921 | \$5,083 | \$5,337 | \$12,407 | \$13,648 | \$14,935 | \$16,429 |
| 65T48228AB_ | 228 | 48 | 3 | \$2,525 | \$3,243 | \$3,406 | \$4,406 | \$4,626 | \$10,196 | \$11,216 | \$12,270 | \$13,498 |
| 65T54228AB_ | 228 | 54 | 3 | \$2,769 | \$3,753 | \$3,940 | \$5,108 | \$5,364 | \$11,403 | \$12,543 | \$13,726 | \$15,098 |
| 65T60228AB_ | 228 | 60 | 3 | \$3,018 | \$3,792 | \$3,981 | \$5,161 | \$5,419 | \$12,744 | \$14,018 | \$15,338 | \$16,872 |
| 65T48234AB_ | 234 | 48 | 3 | \$2,600 | \$3,370 | \$3,538 | \$4,471 | \$4,694 | \$10,462 | \$11,509 | \$12,592 | \$13,851 |
| 65T54234AB_ | 234 | 54 | 3 | \$2,851 | \$3,758 | \$3,945 | \$5,114 | \$5,370 | \$11,736 | \$12,911 | \$14,129 | \$15,542 |
| 65T60234AB_ | 234 | 60 | 3 | \$3,107 | \$3,797 | \$3,987 | \$5,168 | \$5,426 | \$13,076 | \$14,384 | \$15,742 | \$17,316 |
| 65T48240AB_ | 240 | 48 | 3 | \$2,675 | \$3,496 | \$3,671 | \$4,536 | \$4,762 | \$10,730 | \$11,803 | \$12,914 | \$14,204 |
| 65T54240AB_ | 240 | 54 | 3 | \$2,935 | \$3,763 | \$3,951 | \$5,122 | \$5,378 | \$12,070 | \$13,277 | \$14,532 | \$15,985 |
| 65T60240AB_ | 240 | 60 | 3 | \$3,197 | \$3,802 | \$3,993 | \$5,174 | \$5,433 | \$13,411 | \$14,752 | \$16,146 | \$17,760 |

| Model | TFL Top Surface | HPL Top Surface | Top Profile | Veneer Top Material | Top Surface Power Cutout |
|-------|--|--|--|--|--|
| | see Anthology TFL Top Surface Finishes | see Anthology HPL Top Surface Finishes | see Anthology Top Profile Finishes (when applicable) | see Anthology Veneer Top Material Finishes | see Anthology Top Surface Power Cutout |

Racetrack Table Tops

- planning top specification [ANPG_6](#)
- base guide [pages 38-57](#)
- planning power guide [ANPG_20- ANPG_40](#)

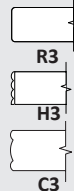
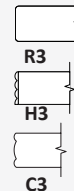
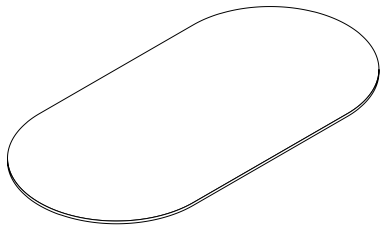

| Model | W | D | Top Pieces | R3 TFL T | R3 HPL Tier 1 H | R3 HPL Tier 2 H | K9 HPL Tier 1 KH | K9 HPL Tier 2 KH | R3 H3 C3 ESS Veneer V | R3 H3 C3 ART Veneer V | K9 ESS Veneer KV | K9 ART Veneer KV |
|--------------|-----|----|------------|----------|-----------------|-----------------|------------------|------------------|-----------------------|-----------------------|------------------|------------------|
| 65T3672RK_ | 72 | 36 | 1 | \$506 | \$827 | \$868 | \$1,208 | \$1,267 | \$2,186 | \$2,405 | \$2,566 | \$2,823 |
| 65T4272RK_ | 72 | 42 | 1 | \$608 | \$887 | \$932 | \$1,292 | \$1,357 | \$2,427 | \$2,670 | \$2,991 | \$3,289 |
| 65T4872RK_ | 72 | 48 | 1 | \$696 | \$892 | \$937 | \$1,296 | \$1,361 | \$2,707 | \$2,978 | \$3,249 | \$3,575 |
| 65T3678RK_ | 78 | 36 | 1 | \$568 | \$945 | \$992 | \$1,238 | \$1,300 | \$2,349 | \$2,584 | \$2,778 | \$3,057 |
| 65T4278RK_ | 78 | 42 | 1 | \$669 | \$981 | \$1,030 | \$1,341 | \$1,407 | \$2,606 | \$2,867 | \$3,131 | \$3,444 |
| 65T4878RK_ | 78 | 48 | 1 | \$758 | \$985 | \$1,035 | \$1,346 | \$1,413 | \$2,907 | \$3,198 | \$3,471 | \$3,817 |
| 65T3684RK_ | 84 | 36 | 1 | \$629 | \$964 | \$1,011 | \$1,256 | \$1,319 | \$2,500 | \$2,751 | \$2,991 | \$3,289 |
| 65T4284RK_ | 84 | 42 | 1 | \$731 | \$1,008 | \$1,058 | \$1,355 | \$1,422 | \$2,777 | \$3,055 | \$3,415 | \$3,756 |
| 65T4884RK_ | 84 | 48 | 1 | \$819 | \$1,012 | \$1,062 | \$1,360 | \$1,428 | \$3,101 | \$3,411 | \$3,755 | \$4,130 |
| 65T3690RK_ | 90 | 36 | 1 | \$691 | \$980 | \$1,029 | \$1,273 | \$1,336 | \$2,657 | \$2,922 | \$3,203 | \$3,523 |
| 65T4290RK_ | 90 | 42 | 1 | \$793 | \$1,035 | \$1,086 | \$1,364 | \$1,432 | \$2,950 | \$3,245 | \$3,700 | \$4,070 |
| 65T4890RK_ | 90 | 48 | 1 | \$880 | \$1,039 | \$1,090 | \$1,368 | \$1,437 | \$3,298 | \$3,627 | \$4,006 | \$4,407 |
| 65T3696RK_ | 96 | 36 | 1 | \$752 | \$998 | \$1,047 | \$1,290 | \$1,355 | \$2,810 | \$3,092 | \$3,415 | \$3,756 |
| 65T4296RK_ | 96 | 42 | 1 | \$854 | \$1,061 | \$1,115 | \$1,372 | \$1,441 | \$3,120 | \$3,432 | \$3,986 | \$4,384 |
| 65T4896RK_ | 96 | 48 | 1 | \$942 | \$1,067 | \$1,119 | \$1,377 | \$1,446 | \$3,450 | \$3,795 | \$4,259 | \$4,684 |
| 65T42102RK1_ | 102 | 42 | 1 | \$886 | \$1,559 | \$1,636 | \$2,120 | \$2,226 | \$3,570 | \$3,928 | \$4,012 | \$4,413 |
| 65T48102RK1_ | 102 | 48 | 1 | \$953 | \$1,567 | \$1,645 | \$2,145 | \$2,252 | \$3,901 | \$4,290 | \$4,694 | \$5,164 |
| 65T42102RK2_ | 102 | 42 | 2 | \$1,098 | \$1,676 | \$1,760 | \$2,281 | \$2,395 | \$3,840 | \$4,225 | \$4,313 | \$4,745 |
| 65T48102RK2_ | 102 | 48 | 2 | \$1,210 | \$1,685 | \$1,769 | \$2,307 | \$2,422 | \$4,195 | \$4,614 | \$5,047 | \$5,552 |
| 65T42108RK1_ | 108 | 42 | 1 | \$934 | \$1,583 | \$1,662 | \$2,125 | \$2,231 | \$3,732 | \$4,105 | \$4,254 | \$4,680 |
| 65T48108RK1_ | 108 | 48 | 1 | \$1,015 | \$1,590 | \$1,670 | \$2,170 | \$2,278 | \$4,062 | \$4,469 | \$4,936 | \$5,430 |
| 65T42108RK2_ | 108 | 42 | 2 | \$1,153 | \$1,702 | \$1,787 | \$2,285 | \$2,399 | \$4,013 | \$4,415 | \$4,574 | \$5,031 |
| 65T48108RK2_ | 108 | 48 | 2 | \$1,270 | \$1,710 | \$1,796 | \$2,332 | \$2,450 | \$4,368 | \$4,804 | \$5,308 | \$5,839 |
| 65T42114RK1_ | 114 | 42 | 2 | \$981 | \$1,607 | \$1,688 | \$2,150 | \$2,257 | \$3,913 | \$4,305 | \$4,528 | \$4,981 |
| 65T48114RK1_ | 114 | 48 | 2 | \$1,077 | \$1,615 | \$1,695 | \$2,194 | \$2,304 | \$4,288 | \$4,717 | \$5,209 | \$5,729 |
| 65T42114RK2_ | 114 | 42 | 2 | \$1,209 | \$1,728 | \$1,814 | \$2,311 | \$2,426 | \$4,208 | \$4,629 | \$4,868 | \$5,355 |
| 65T48114RK2_ | 114 | 48 | 2 | \$1,332 | \$1,737 | \$1,824 | \$2,358 | \$2,477 | \$4,611 | \$5,071 | \$5,602 | \$6,162 |

| Model | TFL Top Surface | HPL Top Surface | Top Profile | Veneer Top Material | Top Surface Power Cutout |
|-------|--|--|--|--|--|
| | see Anthology TFL Top Surface Finishes | see Anthology HPL Top Surface Finishes | see Anthology Top Profile Finishes (when applicable) | see Anthology Veneer Top Material Finishes | see Anthology Top Surface Power Cutout |

Racetrack Table Tops (continued)

- planning top specification [ANPG_6](#)
- base guide [pages 38-57](#)
- planning power guide [ANPG_20- ANPG_40](#)

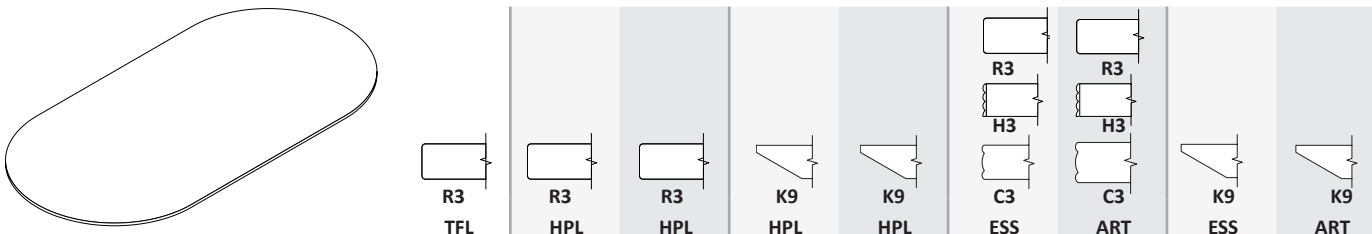

| Model | W | D | Top Pieces | R3 TFL | R3 HPL Tier 1 H | R3 HPL Tier 2 H | K9 HPL Tier 1 KH | K9 HPL Tier 2 KH | ESS Veneer V | ART Veneer V | ESS Veneer KV | ART Veneer KV |
|--------------|-----|----|------------|---------|-----------------|-----------------|------------------|------------------|--------------|--------------|---------------|---------------|
| 65T42120RK1_ | 120 | 42 | 1 | \$1,029 | \$1,631 | \$1,712 | \$2,173 | \$2,282 | \$4,096 | \$4,506 | \$4,800 | \$5,280 |
| 65T48120RK1_ | 120 | 48 | 1 | \$1,139 | \$1,639 | \$1,721 | \$2,217 | \$2,328 | \$4,513 | \$4,964 | \$5,484 | \$6,032 |
| 65T54120RK1_ | 120 | 54 | 1 | \$1,247 | \$1,842 | \$1,934 | \$2,498 | \$2,623 | \$4,975 | \$5,473 | \$6,010 | \$6,611 |
| 65T60120RK1_ | 120 | 60 | 1 | \$1,355 | \$1,861 | \$1,953 | \$2,524 | \$2,650 | \$5,642 | \$6,206 | \$6,859 | \$7,545 |
| 65T42120RK2_ | 120 | 42 | 2 | \$1,263 | \$1,754 | \$1,841 | \$2,337 | \$2,453 | \$4,404 | \$4,844 | \$5,162 | \$5,679 |
| 65T48120RK2_ | 120 | 48 | 2 | \$1,263 | \$1,762 | \$1,850 | \$2,385 | \$2,504 | \$4,853 | \$5,338 | \$5,896 | \$6,486 |
| 65T54120RK2_ | 120 | 54 | 2 | \$1,525 | \$1,980 | \$2,080 | \$2,686 | \$2,821 | \$5,350 | \$5,885 | \$6,462 | \$7,107 |
| 65T60120RK2_ | 120 | 60 | 2 | \$1,655 | \$2,001 | \$2,101 | \$2,714 | \$2,849 | \$6,066 | \$6,673 | \$7,375 | \$8,113 |
| 65T48126RK_ | 126 | 48 | 2 | \$1,452 | \$1,804 | \$1,895 | \$2,487 | \$2,611 | \$5,096 | \$5,605 | \$6,194 | \$6,813 |
| 65T54126RK_ | 126 | 54 | 2 | \$1,585 | \$2,089 | \$2,193 | \$2,949 | \$3,097 | \$5,590 | \$6,149 | \$6,753 | \$7,429 |
| 65T60126RK_ | 126 | 60 | 2 | \$1,724 | \$2,111 | \$2,217 | \$2,980 | \$3,129 | \$6,370 | \$7,007 | \$7,742 | \$8,517 |
| 65T48132RK_ | 132 | 48 | 2 | \$1,508 | \$1,847 | \$1,939 | \$2,589 | \$2,718 | \$5,338 | \$5,873 | \$6,491 | \$7,139 |
| 65T54132RK_ | 132 | 54 | 2 | \$1,648 | \$2,199 | \$2,308 | \$3,213 | \$3,374 | \$5,828 | \$6,411 | \$7,046 | \$7,750 |
| 65T60132RK_ | 132 | 60 | 2 | \$1,793 | \$2,220 | \$2,331 | \$3,246 | \$3,409 | \$6,672 | \$7,339 | \$8,110 | \$8,920 |
| 65T48138RK_ | 138 | 48 | 2 | \$1,565 | \$1,890 | \$1,984 | \$2,692 | \$2,826 | \$5,580 | \$6,138 | \$6,785 | \$7,464 |
| 65T54138RK_ | 138 | 54 | 2 | \$1,712 | \$2,203 | \$2,313 | \$3,220 | \$3,381 | \$6,068 | \$6,675 | \$7,505 | \$8,255 |
| 65T60138RK_ | 138 | 60 | 2 | \$1,862 | \$2,224 | \$2,336 | \$3,252 | \$3,415 | \$6,976 | \$7,673 | \$8,479 | \$9,327 |
| 65T48144RK_ | 144 | 48 | 2 | \$1,621 | \$1,931 | \$2,028 | \$2,792 | \$2,932 | \$5,823 | \$6,405 | \$7,079 | \$7,786 |
| 65T54144RK_ | 144 | 54 | 2 | \$1,776 | \$2,208 | \$2,318 | \$3,225 | \$3,386 | \$6,306 | \$6,937 | \$7,964 | \$8,761 |
| 65T60144RK_ | 144 | 60 | 2 | \$1,931 | \$2,230 | \$2,342 | \$3,258 | \$3,421 | \$7,278 | \$8,007 | \$8,850 | \$9,735 |
| 65T48150RK_ | 150 | 48 | 2 | \$1,678 | \$2,016 | \$2,117 | \$2,865 | \$3,009 | \$6,066 | \$6,673 | \$7,373 | \$8,111 |
| 65T54150RK_ | 150 | 54 | 2 | \$1,838 | \$2,420 | \$2,540 | \$3,414 | \$3,585 | \$6,544 | \$7,198 | \$8,258 | \$9,084 |
| 65T60150RK_ | 150 | 60 | 2 | \$2,000 | \$2,446 | \$2,567 | \$3,441 | \$3,613 | \$7,582 | \$8,340 | \$9,216 | \$10,138 |
| 65T48156RK_ | 156 | 48 | 2 | \$1,735 | \$2,105 | \$2,210 | \$2,939 | \$3,085 | \$6,308 | \$6,939 | \$7,667 | \$8,434 |
| 65T54156RK_ | 156 | 54 | 2 | \$1,901 | \$2,634 | \$2,766 | \$3,587 | \$3,766 | \$6,780 | \$7,458 | \$8,553 | \$9,409 |
| 65T60156RK_ | 156 | 60 | 2 | \$2,069 | \$2,661 | \$2,794 | \$3,623 | \$3,804 | \$7,885 | \$8,674 | \$9,583 | \$10,542 |

| Model | TFL Top Surface | HPL Top Surface | Top Profile | Veneer Top Material | Top Surface Power Cutout |
|-------|--|--|--|--|--|
| | see Anthology TFL Top Surface Finishes | see Anthology HPL Top Surface Finishes | see Anthology Top Profile Finishes (when applicable) | see Anthology Veneer Top Material Finishes | see Anthology Top Surface Power Cutout |

Racetrack Table Tops (continued)

- planning top specification [ANPG_6](#)
- base guide [pages 38-57](#)
- planning power guide [ANPG_20- ANPG_40](#)

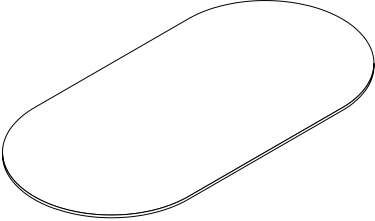

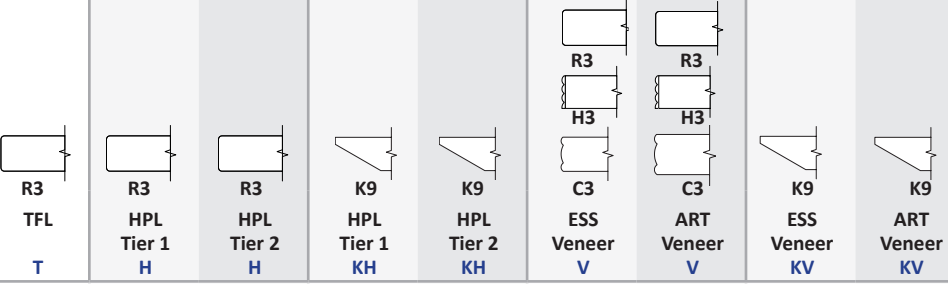
| ① Model | W | D | Top Pieces |  | | | | | | | | | |
|-------------|-----|----|------------|--|---------|---------|---------|---------|----------|----------|----------|----------|--|
| | | | | T | H | H | KH | KH | V | V | KV | KV | |
| 65T48162RK_ | 162 | 48 | 2 | \$1,792 | \$2,185 | \$2,294 | \$3,011 | \$3,162 | \$6,551 | \$7,206 | \$7,962 | \$8,759 | |
| 65T54162RK_ | 162 | 54 | 2 | \$1,964 | \$2,637 | \$2,769 | \$3,592 | \$3,771 | \$7,192 | \$7,911 | \$8,922 | \$9,814 | |
| 65T60162RK_ | 162 | 60 | 2 | \$2,138 | \$2,664 | \$2,797 | \$3,629 | \$3,810 | \$8,189 | \$9,008 | \$9,953 | \$10,948 | |
| 65T48168RK_ | 168 | 48 | 2 | \$1,848 | \$2,270 | \$2,383 | \$3,083 | \$3,237 | \$6,794 | \$7,473 | \$8,255 | \$9,080 | |
| 65T54168RK_ | 168 | 54 | 2 | \$2,027 | \$2,641 | \$2,773 | \$3,599 | \$3,780 | \$7,605 | \$8,365 | \$9,292 | \$10,221 | |
| 65T60168RK_ | 168 | 60 | 2 | \$2,207 | \$2,669 | \$2,802 | \$3,636 | \$3,819 | \$8,492 | \$9,341 | \$10,323 | \$11,356 | |
| 65T48174RK_ | 174 | 48 | 2 | \$1,904 | \$2,274 | \$2,387 | \$3,089 | \$3,244 | \$7,035 | \$7,739 | \$8,553 | \$9,409 | |
| 65T54174RK_ | 174 | 54 | 2 | \$2,089 | \$2,643 | \$2,776 | \$3,604 | \$3,785 | \$7,868 | \$8,655 | \$9,587 | \$10,545 | |
| 65T60174RK_ | 174 | 60 | 2 | \$2,276 | \$2,671 | \$2,805 | \$3,642 | \$3,824 | \$8,795 | \$9,674 | \$10,690 | \$11,758 | |
| 65T48180RK_ | 180 | 48 | 2 | \$1,961 | \$2,277 | \$2,390 | \$3,095 | \$3,249 | \$7,278 | \$8,007 | \$8,850 | \$9,735 | |
| 65T54180RK_ | 180 | 54 | 2 | \$2,151 | \$2,652 | \$2,785 | \$3,613 | \$3,793 | \$8,130 | \$8,944 | \$9,880 | \$10,868 | |
| 65T60180RK_ | 180 | 60 | 2 | \$2,345 | \$2,680 | \$2,813 | \$3,650 | \$3,832 | \$9,098 | \$10,008 | \$11,057 | \$12,162 | |
| 65T48186RK_ | 186 | 48 | 2 | \$2,018 | \$2,281 | \$2,395 | \$3,102 | \$3,257 | \$7,522 | \$8,273 | \$9,144 | \$10,058 | |
| 65T54186RK_ | 186 | 54 | 2 | \$2,215 | \$2,657 | \$2,789 | \$3,618 | \$3,798 | \$8,377 | \$9,216 | \$10,247 | \$11,272 | |
| 65T60186RK_ | 186 | 60 | 2 | \$2,414 | \$2,683 | \$2,818 | \$3,655 | \$3,837 | \$9,401 | \$10,342 | \$11,427 | \$12,570 | |
| 65T48192RK_ | 192 | 48 | 2 | \$2,075 | \$2,286 | \$2,400 | \$3,108 | \$3,264 | \$7,764 | \$8,540 | \$9,437 | \$10,382 | |
| 65T54192RK_ | 192 | 54 | 2 | \$2,279 | \$2,661 | \$2,794 | \$3,623 | \$3,804 | \$8,627 | \$9,490 | \$10,615 | \$11,676 | |
| 65T60192RK_ | 192 | 60 | 2 | \$2,484 | \$2,687 | \$2,822 | \$3,661 | \$3,844 | \$9,705 | \$10,675 | \$11,797 | \$12,976 | |
| 65T48198RK_ | 198 | 48 | 2 | \$2,150 | \$3,182 | \$3,342 | \$4,296 | \$4,510 | \$8,863 | \$9,748 | \$10,719 | \$11,790 | |
| 65T54198RK_ | 198 | 54 | 2 | \$2,360 | \$3,623 | \$3,804 | \$4,934 | \$5,180 | \$9,862 | \$10,848 | \$11,867 | \$13,054 | |
| 65T60198RK_ | 198 | 60 | 2 | \$2,572 | \$3,661 | \$3,844 | \$4,984 | \$5,233 | \$11,069 | \$12,176 | \$13,321 | \$14,653 | |
| 65T48204RK_ | 204 | 48 | 3 | \$2,224 | \$3,226 | \$3,387 | \$4,379 | \$4,598 | \$9,122 | \$10,035 | \$10,978 | \$12,076 | |
| 65T54204RK_ | 204 | 54 | 3 | \$2,443 | \$3,631 | \$3,813 | \$4,940 | \$5,188 | \$10,196 | \$11,216 | \$12,270 | \$13,498 | |
| 65T60204RK_ | 204 | 60 | 3 | \$2,662 | \$3,669 | \$3,853 | \$4,992 | \$5,241 | \$11,403 | \$12,543 | \$13,726 | \$15,098 | |
| 65T48210RK_ | 210 | 48 | 3 | \$2,300 | \$3,231 | \$3,392 | \$4,387 | \$4,606 | \$9,389 | \$10,327 | \$11,300 | \$12,430 | |
| 65T54210RK_ | 210 | 54 | 3 | \$2,524 | \$3,635 | \$3,818 | \$4,947 | \$5,194 | \$10,529 | \$11,582 | \$12,674 | \$13,941 | |
| 65T60210RK_ | 210 | 60 | 3 | \$2,751 | \$3,672 | \$3,857 | \$4,998 | \$5,247 | \$11,736 | \$12,911 | \$14,129 | \$15,542 | |

| Model | TFL Top Surface | HPL Top Surface | Top Profile | Veneer Top Material | Top Surface Power Cutout |
|-------|--|--|--|--|--|
| | see Anthology TFL Top Surface Finishes | see Anthology HPL Top Surface Finishes | see Anthology Top Profile Finishes (when applicable) | see Anthology Veneer Top Material Finishes | see Anthology Top Surface Power Cutout |

- planning top specification [ANPG_6](#)
- base guide [pages 38-57](#)
- planning power guide [ANPG_20- ANPG_40](#)

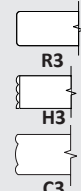
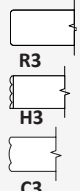
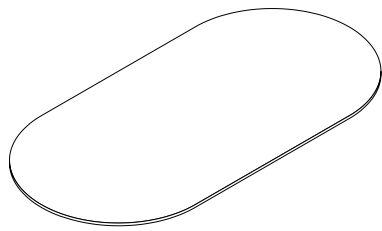

| ① Model | W | D | Top Pieces | R3 TFL T | R3 HPL Tier 1 H | R3 HPL Tier 2 H | K9 HPL Tier 1 KH | K9 HPL Tier 2 KH | R3 H3 C3 ESS Veneer V | R3 H3 C3 ART Veneer V | K9 ESS Veneer KV | K9 ART Veneer KV |
|-------------|-----|----|------------|-------------|--------------------|--------------------|---------------------|---------------------|-----------------------------|-----------------------------|------------------------|------------------------|
| 65T48216RK_ | 216 | 48 | 3 | \$2,375 | \$3,235 | \$3,396 | \$4,394 | \$4,614 | \$9,657 | \$10,622 | \$11,621 | \$12,783 |
| 65T54216RK_ | 216 | 54 | 3 | \$2,605 | \$3,639 | \$3,822 | \$4,953 | \$5,200 | \$10,864 | \$11,950 | \$13,076 | \$14,384 |
| 65T60216RK_ | 216 | 60 | 3 | \$2,840 | \$3,677 | \$3,861 | \$5,003 | \$5,253 | \$12,070 | \$13,277 | \$14,532 | \$15,985 |
| 65T48222RK_ | 222 | 48 | 3 | \$2,450 | \$3,239 | \$3,401 | \$4,400 | \$4,619 | \$9,926 | \$10,918 | \$11,945 | \$13,140 |
| 65T54222RK_ | 222 | 54 | 3 | \$2,687 | \$3,696 | \$3,881 | \$5,031 | \$5,282 | \$11,133 | \$12,246 | \$13,401 | \$14,741 |
| 65T60222RK_ | 222 | 60 | 3 | \$2,929 | \$3,734 | \$3,921 | \$5,083 | \$5,337 | \$12,407 | \$13,648 | \$14,935 | \$16,429 |
| 65T48228RK_ | 228 | 48 | 3 | \$2,525 | \$3,243 | \$3,406 | \$4,406 | \$4,626 | \$10,196 | \$11,216 | \$12,270 | \$13,498 |
| 65T54228RK_ | 228 | 54 | 3 | \$2,769 | \$3,753 | \$3,940 | \$5,108 | \$5,364 | \$11,403 | \$12,543 | \$13,726 | \$15,098 |
| 65T60228RK_ | 228 | 60 | 3 | \$3,018 | \$3,792 | \$3,981 | \$5,161 | \$5,419 | \$12,744 | \$14,018 | \$15,338 | \$16,872 |
| 65T48234RK_ | 234 | 48 | 3 | \$2,600 | \$3,370 | \$3,538 | \$4,471 | \$4,694 | \$10,462 | \$11,509 | \$12,592 | \$13,851 |
| 65T54234RK_ | 234 | 54 | 3 | \$2,851 | \$3,758 | \$3,945 | \$5,114 | \$5,370 | \$11,736 | \$12,911 | \$14,129 | \$15,542 |
| 65T60234RK_ | 234 | 60 | 3 | \$3,107 | \$3,797 | \$3,987 | \$5,168 | \$5,426 | \$13,076 | \$14,384 | \$15,742 | \$17,316 |
| 65T48240RK_ | 240 | 48 | 3 | \$2,675 | \$3,496 | \$3,671 | \$4,536 | \$4,762 | \$10,730 | \$11,803 | \$12,914 | \$14,204 |
| 65T54240RK_ | 240 | 54 | 3 | \$2,935 | \$3,763 | \$3,951 | \$5,122 | \$5,378 | \$12,070 | \$13,277 | \$14,532 | \$15,985 |
| 65T60240RK_ | 240 | 60 | 3 | \$3,197 | \$3,802 | \$3,993 | \$5,174 | \$5,433 | \$13,411 | \$14,752 | \$16,146 | \$17,760 |

| Model | TFL Top Surface | HPL Top Surface | Top Profile | Veneer Top Material | Top Surface Power Cutout |
|-------|--|--|--|--|--|
| | see Anthology TFL Top Surface Finishes | see Anthology HPL Top Surface Finishes | see Anthology Top Profile Finishes (when applicable) | see Anthology Veneer Top Material Finishes | see Anthology Top Surface Power Cutout |

Round Table Tops

- planning top specification [ANPG_6](#)
- base guide [pages 38-57](#)
- planning power guide [ANPG_20- ANPG_40](#)

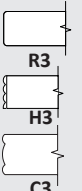
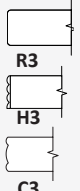
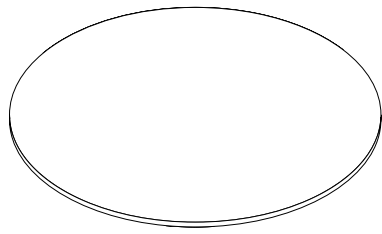

| ① Model | W | D | Top Pieces | T R3 TFL | H R3 HPL Tier 1 H | H R3 HPL Tier 2 H | KH K9 HPL Tier 1 KH | KH K9 HPL Tier 2 KH | V ESS Veneer V | V ART Veneer V | KV ESS Veneer KV | KV ART Veneer KV |
|----------|----|----|------------|----------------|-------------------------------|-------------------------------|---------------------------------|---------------------------------|-------------------------|-------------------------|---------------------------|---------------------------|
| 65T36RD_ | 36 | 36 | 1 | \$410 | \$416 | \$436 | \$705 | \$740 | \$1,997 | \$2,196 | \$2,579 | \$2,836 |
| 65T42RD_ | 42 | 42 | 1 | \$521 | \$579 | \$608 | \$811 | \$851 | \$2,542 | \$2,795 | \$3,222 | \$3,544 |
| 65T48RD_ | 48 | 48 | 1 | \$573 | \$579 | \$608 | \$824 | \$866 | \$3,047 | \$3,351 | \$3,870 | \$4,257 |
| 65T54RD_ | 54 | 54 | 1 | \$716 | \$734 | \$770 | \$1,071 | \$1,124 | \$3,808 | \$4,188 | \$4,838 | \$5,323 |
| 65T60RD_ | 60 | 60 | 1 | \$757 | \$771 | \$809 | \$1,106 | \$1,160 | \$5,075 | \$5,582 | \$6,448 | \$7,093 |

| Model | TFL Top Surface | HPL Top Surface | Top Profile | Veneer Top Material | Top Surface Power Cutout |
|-------|--|--|---|--|--|
| | see Anthology TFL Top Surface Finishes | see Anthology HPL Top Surface Finishes | see Anthology Top Profile Finishes (when applicable) | see Anthology Veneer Top Material Finishes | see Anthology Top Surface Power Cutout |

Bridge Base Kit

- available in Maple, Oak and Walnut solid wood
- top shapes: Rectangular, Soft Rectangular, Arc Rectangular, Boat, Arc Boat and Racetrack
- planning base specification [ANPG_8](#)
- planning base location [ANPG_18](#)
- planning power guide [ANPG_20- ANPG_40](#)

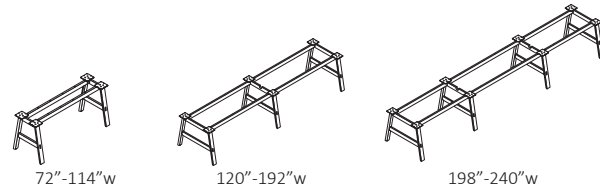

| D | W | H | CTN WT | CU FT | Model | Description | List Price |
|--|-----|-----|--------|-------|---------------------|--|----------------|
| Bridge Base Kit for 36/42" deep Table | | | | | | | |
| 24 | 48 | 27½ | 54 | 7 | 65T2472BGBW | Bridge Solid Wood Base Kit for 36/42"d x 72"w Top Surfaces | \$2,310 |
| 24 | 54 | 27½ | 54 | 7 | 65T2478BGBW | Bridge Solid Wood Base Kit for 36/42"d x 78"w Top Surfaces | \$2,323 |
| 24 | 54 | 27½ | 54 | 7 | 65T2484BGBW | Bridge Solid Wood Base Kit for 36/42"d x 84"w Top Surfaces | \$2,337 |
| 24 | 60 | 27½ | 55 | 7 | 65T2490BGBW | Bridge Solid Wood Base Kit for 36/42"d x 90"w Top Surfaces | \$2,350 |
| 24 | 60 | 27½ | 55 | 7 | 65T2496BGBW | Bridge Solid Wood Base Kit for 36/42"d x 96"w Top Surfaces | \$2,363 |
| Bridge Base Kit for 42" deep Table | | | | | | | |
| 24 | 66 | 27½ | 56 | 7 | 65T24102BGBW | Bridge Solid Wood Base Kit for 42"d x 102"w Top Surfaces | \$2,377 |
| 24 | 72 | 27½ | 56 | 7 | 65T24108BGBW | Bridge Solid Wood Base Kit for 42"d x 108"w Top Surfaces | \$2,390 |
| 24 | 78 | 27½ | 56 | 7 | 65T24114BGBW | Bridge Solid Wood Base Kit for 42"d x 114"w Top Surfaces | \$2,403 |
| 24 | 84 | 27½ | 76 | 10 | 65T24120BGBW | Bridge Solid Wood Base Kit for 42"d x 120"w Top Surfaces | \$2,417 |
| Bridge Base Kit for 48" deep Table | | | | | | | |
| 30 | 48 | 27½ | 56 | 9 | 65T3072BGBW | Bridge Solid Wood Base Kit for 48"d x 72"w Top Surfaces | \$2,431 |
| 30 | 54 | 27½ | 56 | 9 | 65T3078BGBW | Bridge Solid Wood Base Kit for 48"d x 78"w Top Surfaces | \$2,445 |
| 30 | 54 | 27½ | 56 | 9 | 65T3084BGBW | Bridge Solid Wood Base Kit for 48"d x 84"w Top Surfaces | \$2,458 |
| 30 | 60 | 27½ | 56 | 9 | 65T3090BGBW | Bridge Solid Wood Base Kit for 48"d x 90"w Top Surfaces | \$2,471 |
| 30 | 60 | 27½ | 57 | 10 | 65T3096BGBW | Bridge Solid Wood Base Kit for 48"d x 96"w Top Surfaces | \$2,486 |
| 30 | 66 | 27½ | 57 | 10 | 65T30102BGBW | Bridge Solid Wood Base Kit for 48"d x 102"w Top Surfaces | \$2,761 |
| 30 | 72 | 27½ | 57 | 10 | 65T30108BGBW | Bridge Solid Wood Base Kit for 48"d x 108"w Top Surfaces | \$3,036 |
| 30 | 78 | 27½ | 57 | 10 | 65T30114BGBW | Bridge Solid Wood Base Kit for 48"d x 114"w Top Surfaces | \$3,311 |
| 30 | 84 | 27½ | 77 | 15 | 65T30120BGBW | Bridge Solid Wood Base Kit for 48"d x 120"w Top Surfaces | \$3,586 |
| 30 | 90 | 27½ | 77 | 15 | 65T30126BGBW | Bridge Solid Wood Base Kit for 48"d x 126"w Top Surfaces | \$3,592 |
| 30 | 96 | 27½ | 77 | 15 | 65T30132BGBW | Bridge Solid Wood Base Kit for 48"d x 132"w Top Surfaces | \$3,598 |
| 30 | 102 | 27½ | 77 | 15 | 65T30138BGBW | Bridge Solid Wood Base Kit for 48"d x 138"w Top Surfaces | \$3,604 |
| 30 | 108 | 27½ | 78 | 15 | 65T30144BGBW | Bridge Solid Wood Base Kit for 48"d x 144"w Top Surfaces | \$3,612 |
| 30 | 114 | 27½ | 78 | 15 | 65T30150BGBW | Bridge Solid Wood Base Kit for 48"d x 150"w Top Surfaces | \$3,618 |
| 30 | 120 | 27½ | 78 | 15 | 65T30156BGBW | Bridge Solid Wood Base Kit for 48"d x 156"w Top Surfaces | \$3,624 |
| 30 | 126 | 27½ | 78 | 15 | 65T30162BGBW | Bridge Solid Wood Base Kit for 48"d x 162"w Top Surfaces | \$3,630 |
| 30 | 132 | 27½ | 79 | 15 | 65T30168BGBW | Bridge Solid Wood Base Kit for 48"d x 168"w Top Surfaces | \$3,636 |
| 30 | 138 | 27½ | 79 | 15 | 65T30174BGBW | Bridge Solid Wood Base Kit for 48"d x 174"w Top Surfaces | \$3,643 |
| 30 | 144 | 27½ | 79 | 15 | 65T30180BGBW | Bridge Solid Wood Base Kit for 48"d x 180"w Top Surfaces | \$3,649 |
| 30 | 150 | 27½ | 80 | 15 | 65T30186BGBW | Bridge Solid Wood Base Kit for 48"d x 186"w Top Surfaces | \$3,655 |
| 30 | 156 | 27½ | 80 | 15 | 65T30192BGBW | Bridge Solid Wood Base Kit for 48"d x 192"w Top Surfaces | \$3,662 |
| 30 | 162 | 27½ | 101 | 19 | 65T30198BGBW | Bridge Solid Wood Base Kit for 48"d x 198"w Top Surfaces | \$3,790 |
| 30 | 168 | 27½ | 101 | 19 | 65T30204BGBW | Bridge Solid Wood Base Kit for 48"d x 204"w Top Surfaces | \$3,918 |
| 30 | 174 | 27½ | 102 | 19 | 65T30210BGBW | Bridge Solid Wood Base Kit for 48"d x 210"w Top Surfaces | \$4,045 |
| 30 | 180 | 27½ | 102 | 20 | 65T30216BGBW | Bridge Solid Wood Base Kit for 48"d x 216"w Top Surfaces | \$4,173 |
| 30 | 186 | 27½ | 105 | 20 | 65T30222BGBW | Bridge Solid Wood Base Kit for 48"d x 222"w Top Surfaces | \$4,301 |
| 30 | 192 | 27½ | 105 | 20 | 65T30228BGBW | Bridge Solid Wood Base Kit for 48"d x 228"w Top Surfaces | \$4,428 |
| 30 | 198 | 27½ | 107 | 20 | 65T30234BGBW | Bridge Solid Wood Base Kit for 48"d x 234"w Top Surfaces | \$4,556 |
| 30 | 204 | 27½ | 107 | 20 | 65T30240BGBW | Bridge Solid Wood Base Kit for 48"d x 240"w Top Surfaces | \$4,682 |

Model Base Wood

[see Anthology Solid Wood Finishes](#)

Bridge Base Kit

- available in Maple, Oak and Walnut solid wood
- top shapes: Rectangular, Soft Rectangular, Arc Rectangular, Boat, Arc Boat and Racetrack
- planning base specification [ANPG_8](#)
- planning base location [ANPG_18](#)
- planning power guide [ANPG_20- ANPG_40](#)

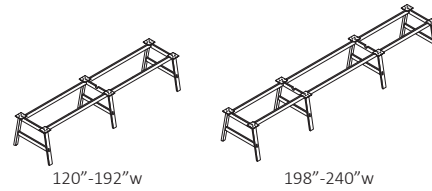

| D | W | H | CTN WT | CU FT | Model | Description | List Price |
|---|-----|------------------|--------|-------|---------------------|---|----------------|
| Bridge Base Kit for 54/60"deep Table | | | | | | | |
| 36 | 84 | 27 $\frac{7}{8}$ | 93 | 19 | 65T36120BGBW | Bridge Solid Wood Base Kit for 54/60"d x 120"w Top Surfaces | \$3,639 |
| 36 | 90 | 27 $\frac{7}{8}$ | 93 | 19 | 65T36126BGBW | Bridge Solid Wood Base Kit for 54/60"d x 126"w Top Surfaces | \$3,646 |
| 36 | 96 | 27 $\frac{7}{8}$ | 94 | 19 | 65T36132BGBW | Bridge Solid Wood Base Kit for 54/60"d x 132"w Top Surfaces | \$3,652 |
| 36 | 102 | 27 $\frac{7}{8}$ | 94 | 19 | 65T36138BGBW | Bridge Solid Wood Base Kit for 54/60"d x 138"w Top Surfaces | \$3,658 |
| 36 | 108 | 27 $\frac{7}{8}$ | 95 | 19 | 65T36144BGBW | Bridge Solid Wood Base Kit for 54/60"d x 144"w Top Surfaces | \$3,665 |
| 36 | 114 | 27 $\frac{7}{8}$ | 95 | 19 | 65T36150BGBW | Bridge Solid Wood Base Kit for 54/60"d x 150"w Top Surfaces | \$3,671 |
| 36 | 120 | 27 $\frac{7}{8}$ | 95 | 19 | 65T36156BGBW | Bridge Solid Wood Base Kit for 54/60"d x 156"w Top Surfaces | \$3,678 |
| 36 | 126 | 27 $\frac{7}{8}$ | 97 | 19 | 65T36162BGBW | Bridge Solid Wood Base Kit for 54/60"d x 162"w Top Surfaces | \$3,684 |
| 36 | 132 | 27 $\frac{7}{8}$ | 97 | 19 | 65T36168BGBW | Bridge Solid Wood Base Kit for 54/60"d x 168"w Top Surfaces | \$3,690 |
| 36 | 138 | 27 $\frac{7}{8}$ | 97 | 19 | 65T36174BGBW | Bridge Solid Wood Base Kit for 54/60"d x 174"w Top Surfaces | \$3,697 |
| 36 | 144 | 27 $\frac{7}{8}$ | 99 | 19 | 65T36180BGBW | Bridge Solid Wood Base Kit for 54/60"d x 180"w Top Surfaces | \$3,703 |
| 36 | 150 | 27 $\frac{7}{8}$ | 99 | 19 | 65T36186BGBW | Bridge Solid Wood Base Kit for 54/60"d x 186"w Top Surfaces | \$3,710 |
| 36 | 156 | 27 $\frac{7}{8}$ | 99 | 19 | 65T36192BGBW | Bridge Solid Wood Base Kit for 54/60"d x 192"w Top Surfaces | \$3,717 |
| 36 | 162 | 27 $\frac{7}{8}$ | 116 | 23 | 65T36198BGBW | Bridge Solid Wood Base Kit for 54/60"d x 198"w Top Surfaces | \$3,847 |
| 36 | 168 | 27 $\frac{7}{8}$ | 116 | 23 | 65T36204BGBW | Bridge Solid Wood Base Kit for 54/60"d x 204"w Top Surfaces | \$3,976 |
| 36 | 174 | 27 $\frac{7}{8}$ | 116 | 23 | 65T36210BGBW | Bridge Solid Wood Base Kit for 54/60"d x 210"w Top Surfaces | \$4,106 |
| 36 | 180 | 27 $\frac{7}{8}$ | 118 | 24 | 65T36216BGBW | Bridge Solid Wood Base Kit for 54/60"d x 216"w Top Surfaces | \$4,236 |
| 36 | 186 | 27 $\frac{7}{8}$ | 118 | 24 | 65T36222BGBW | Bridge Solid Wood Base Kit for 54/60"d x 222"w Top Surfaces | \$4,366 |
| 36 | 192 | 27 $\frac{7}{8}$ | 120 | 24 | 65T36228BGBW | Bridge Solid Wood Base Kit for 54/60"d x 228"w Top Surfaces | \$4,495 |
| 36 | 198 | 27 $\frac{7}{8}$ | 120 | 24 | 65T36234BGBW | Bridge Solid Wood Base Kit for 54/60"d x 234"w Top Surfaces | \$4,625 |
| 36 | 204 | 27 $\frac{7}{8}$ | 120 | 42 | 65T36240BGBW | Bridge Solid Wood Base Kit for 54/60"d x 240"w Top Surfaces | \$4,754 |

Model | **Base Wood**

[see Anthology Solid Wood Finishes](#)

Bevel Base Kit

- available in Maple, Oak and Walnut solid wood
- top shapes: Rectangular, Soft Rectangular, Arc Rectangular, Boat, Arc Boat and Racetrack
- planning base specification [ANPG_7](#)
- planning base location [ANPG_18](#)
- planning power guide [ANPG_20- ANPG_40](#)

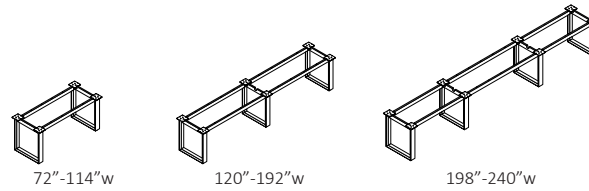

| D | W | H | CTN WT | CU FT | Model | Description | List Price |
|--|-----|------------------|--------|-------|---------------------|--|----------------|
| Bevel Base Kit for 36"deep Table | | | | | | | |
| 18 | 48 | 27 $\frac{7}{8}$ | 54 | 7 | 65T1872BVBW | Bevel Solid Wood Base Kit for 36"d x 72"w Top Surfaces | \$2,312 |
| 18 | 54 | 27 $\frac{7}{8}$ | 54 | 7 | 65T1878BVBW | Bevel Solid Wood Base Kit for 36"d x 78"w Top Surfaces | \$2,318 |
| 18 | 54 | 27 $\frac{7}{8}$ | 54 | 7 | 65T1884BVBW | Bevel Solid Wood Base Kit for 36"d x 84"w Top Surfaces | \$2,324 |
| 18 | 60 | 27 $\frac{7}{8}$ | 55 | 7 | 65T1890BVBW | Bevel Solid Wood Base Kit for 36"d x 90"w Top Surfaces | \$2,330 |
| 18 | 60 | 27 $\frac{7}{8}$ | 55 | 7 | 65T1896BVBW | Bevel Solid Wood Base Kit for 36"d x 96"w Top Surfaces | \$2,337 |
| Bevel Base Kit for 42/48"deep Table | | | | | | | |
| 24 | 48 | 27 $\frac{7}{8}$ | 56 | 9 | 65T2472BVBW | Bevel Solid Wood Base Kit for 42/48"d x 72"w Top Surfaces | \$2,312 |
| 24 | 54 | 27 $\frac{7}{8}$ | 56 | 9 | 65T2478BVBW | Bevel Solid Wood Base Kit for 42/48"d x 78"w Top Surfaces | \$2,318 |
| 24 | 54 | 27 $\frac{7}{8}$ | 56 | 9 | 65T2484BVBW | Bevel Solid Wood Base Kit for 42/48"d x 84"w Top Surfaces | \$2,324 |
| 24 | 60 | 27 $\frac{7}{8}$ | 56 | 9 | 65T2490BVBW | Bevel Solid Wood Base Kit for 42/48"d x 90"w Top Surfaces | \$2,330 |
| 24 | 60 | 27 $\frac{7}{8}$ | 57 | 10 | 65T2496BVBW | Bevel Solid Wood Base Kit for 42/48"d x 96"w Top Surfaces | \$2,337 |
| 24 | 66 | 27 $\frac{7}{8}$ | 57 | 10 | 65T24102BVBW | Bevel Solid Wood Base Kit for 42/48"d x 102"w Top Surfaces | \$2,588 |
| 24 | 72 | 27 $\frac{7}{8}$ | 57 | 10 | 65T24108BVBW | Bevel Solid Wood Base Kit for 42/48"d x 108"w Top Surfaces | \$2,839 |
| 24 | 78 | 27 $\frac{7}{8}$ | 57 | 10 | 65T24114BVBW | Bevel Solid Wood Base Kit for 42/48"d x 114"w Top Surfaces | \$3,090 |
| 24 | 84 | 27 $\frac{7}{8}$ | 77 | 15 | 65T24120BVBW | Bevel Solid Wood Base Kit for 42/48"d x 120"w Top Surfaces | \$3,554 |
| Bevel Base Kit for 48"deep Table | | | | | | | |
| 24 | 90 | 27 $\frac{7}{8}$ | 77 | 15 | 65T24126BVBW | Bevel Solid Wood Base Kit for 48"d x 126"w Top Surfaces | \$3,599 |
| 24 | 96 | 27 $\frac{7}{8}$ | 77 | 15 | 65T24132BVBW | Bevel Solid Wood Base Kit for 48"d x 132"w Top Surfaces | \$3,605 |
| 24 | 102 | 27 $\frac{7}{8}$ | 77 | 15 | 65T24138BVBW | Bevel Solid Wood Base Kit for 48"d x 138"w Top Surfaces | \$3,612 |
| 24 | 108 | 27 $\frac{7}{8}$ | 78 | 15 | 65T24144BVBW | Bevel Solid Wood Base Kit for 48"d x 144"w Top Surfaces | \$3,619 |
| 24 | 114 | 27 $\frac{7}{8}$ | 78 | 15 | 65T24150BVBW | Bevel Solid Wood Base Kit for 48"d x 150"w Top Surfaces | \$3,625 |
| 24 | 120 | 27 $\frac{7}{8}$ | 78 | 15 | 65T24156BVBW | Bevel Solid Wood Base Kit for 48"d x 156"w Top Surfaces | \$3,631 |
| 24 | 126 | 27 $\frac{7}{8}$ | 78 | 15 | 65T24162BVBW | Bevel Solid Wood Base Kit for 48"d x 162"w Top Surfaces | \$3,637 |
| 24 | 132 | 27 $\frac{7}{8}$ | 79 | 15 | 65T24168BVBW | Bevel Solid Wood Base Kit for 48"d x 168"w Top Surfaces | \$3,644 |
| 24 | 138 | 27 $\frac{7}{8}$ | 79 | 15 | 65T24174BVBW | Bevel Solid Wood Base Kit for 48"d x 174"w Top Surfaces | \$3,650 |
| 24 | 144 | 27 $\frac{7}{8}$ | 79 | 15 | 65T24180BVBW | Bevel Solid Wood Base Kit for 48"d x 180"w Top Surfaces | \$3,656 |
| 24 | 150 | 27 $\frac{7}{8}$ | 80 | 15 | 65T24186BVBW | Bevel Solid Wood Base Kit for 48"d x 186"w Top Surfaces | \$3,662 |
| 24 | 156 | 27 $\frac{7}{8}$ | 80 | 15 | 65T24192BVBW | Bevel Solid Wood Base Kit for 48"d x 192"w Top Surfaces | \$3,669 |
| 24 | 162 | 27 $\frac{7}{8}$ | 101 | 19 | 65T24198BVBW | Bevel Solid Wood Base Kit for 48"d x 198"w Top Surfaces | \$3,797 |
| 24 | 168 | 27 $\frac{7}{8}$ | 101 | 19 | 65T24204BVBW | Bevel Solid Wood Base Kit for 48"d x 204"w Top Surfaces | \$3,925 |
| 24 | 174 | 27 $\frac{7}{8}$ | 102 | 19 | 65T24210BVBW | Bevel Solid Wood Base Kit for 48"d x 210"w Top Surfaces | \$4,053 |
| 24 | 180 | 27 $\frac{7}{8}$ | 102 | 20 | 65T24216BVBW | Bevel Solid Wood Base Kit for 48"d x 216"w Top Surfaces | \$4,180 |
| 24 | 186 | 27 $\frac{7}{8}$ | 105 | 20 | 65T24222BVBW | Bevel Solid Wood Base Kit for 48"d x 222"w Top Surfaces | \$4,308 |
| 24 | 192 | 27 $\frac{7}{8}$ | 105 | 20 | 65T24228BVBW | Bevel Solid Wood Base Kit for 48"d x 228"w Top Surfaces | \$4,436 |
| 24 | 198 | 27 $\frac{7}{8}$ | 107 | 20 | 65T24234BVBW | Bevel Solid Wood Base Kit for 48"d x 234"w Top Surfaces | \$4,563 |
| 24 | 204 | 27 $\frac{7}{8}$ | 107 | 20 | 65T24240BVBW | Bevel Solid Wood Base Kit for 48"d x 240"w Top Surfaces | \$4,691 |

Model Base Wood

[see Anthology Solid Wood Finishes](#)

Bevel Base Kit

- available in Maple, Oak and Walnut solid wood
- top shapes: Rectangular, Soft Rectangular, Arc Rectangular, Boat, Arc Boat and Racetrack
- planning base specification [ANPG_7](#)
- planning base location [ANPG_18](#)
- planning power guide [ANPG_20- ANPG_40](#)

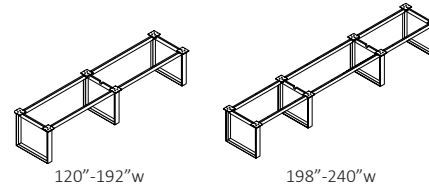

| D | W | H | CTN WT | CU FT | Model | Description | List Price |
|--|-----|------------------|--------|-------|--------------------|--|----------------|
| Bevel Base Kit for 54/60"deep Table | | | | | | | |
| 30 | 84 | 27 $\frac{7}{8}$ | 93 | 19 | 65T30120VBW | Bevel Solid Wood Base Kit for 54/60"d x 120"w Top Surfaces | \$3,716 |
| 30 | 90 | 27 $\frac{7}{8}$ | 93 | 19 | 65T30126VBW | Bevel Solid Wood Base Kit for 54/60"d x 126"w Top Surfaces | \$3,721 |
| 30 | 96 | 27 $\frac{7}{8}$ | 94 | 19 | 65T30132VBW | Bevel Solid Wood Base Kit for 54/60"d x 132"w Top Surfaces | \$3,726 |
| 30 | 102 | 27 $\frac{7}{8}$ | 94 | 19 | 65T30138VBW | Bevel Solid Wood Base Kit for 54/60"d x 138"w Top Surfaces | \$3,731 |
| 30 | 108 | 27 $\frac{7}{8}$ | 95 | 19 | 65T30144VBW | Bevel Solid Wood Base Kit for 54/60"d x 144"w Top Surfaces | \$3,740 |
| 30 | 114 | 27 $\frac{7}{8}$ | 95 | 19 | 65T30150VBW | Bevel Solid Wood Base Kit for 54/60"d x 150"w Top Surfaces | \$3,747 |
| 30 | 120 | 27 $\frac{7}{8}$ | 95 | 19 | 65T30156VBW | Bevel Solid Wood Base Kit for 54/60"d x 156"w Top Surfaces | \$3,753 |
| 30 | 126 | 27 $\frac{7}{8}$ | 97 | 19 | 65T30162VBW | Bevel Solid Wood Base Kit for 54/60"d x 162"w Top Surfaces | \$3,759 |
| 30 | 132 | 27 $\frac{7}{8}$ | 97 | 19 | 65T30168VBW | Bevel Solid Wood Base Kit for 54/60"d x 168"w Top Surfaces | \$3,765 |
| 30 | 138 | 27 $\frac{7}{8}$ | 97 | 19 | 65T30174VBW | Bevel Solid Wood Base Kit for 54/60"d x 174"w Top Surfaces | \$3,772 |
| 30 | 144 | 27 $\frac{7}{8}$ | 99 | 19 | 65T30180VBW | Bevel Solid Wood Base Kit for 54/60"d x 180"w Top Surfaces | \$3,779 |
| 30 | 150 | 27 $\frac{7}{8}$ | 99 | 19 | 65T30186VBW | Bevel Solid Wood Base Kit for 54/60"d x 186"w Top Surfaces | \$3,785 |
| 30 | 156 | 27 $\frac{7}{8}$ | 99 | 19 | 65T30192VBW | Bevel Solid Wood Base Kit for 54/60"d x 192"w Top Surfaces | \$3,792 |
| 30 | 162 | 27 $\frac{7}{8}$ | 116 | 23 | 65T30198VBW | Bevel Solid Wood Base Kit for 54/60"d x 198"w Top Surfaces | \$3,925 |
| 30 | 168 | 27 $\frac{7}{8}$ | 116 | 23 | 65T30204VBW | Bevel Solid Wood Base Kit for 54/60"d x 204"w Top Surfaces | \$4,058 |
| 30 | 174 | 27 $\frac{7}{8}$ | 116 | 23 | 65T30210VBW | Bevel Solid Wood Base Kit for 54/60"d x 210"w Top Surfaces | \$4,191 |
| 30 | 180 | 27 $\frac{7}{8}$ | 118 | 24 | 65T30216VBW | Bevel Solid Wood Base Kit for 54/60"d x 216"w Top Surfaces | \$4,323 |
| 30 | 186 | 27 $\frac{7}{8}$ | 118 | 24 | 65T30222VBW | Bevel Solid Wood Base Kit for 54/60"d x 222"w Top Surfaces | \$4,456 |
| 30 | 192 | 27 $\frac{7}{8}$ | 120 | 24 | 65T30228VBW | Bevel Solid Wood Base Kit for 54/60"d x 228"w Top Surfaces | \$4,589 |
| 30 | 198 | 27 $\frac{7}{8}$ | 120 | 24 | 65T30234VBW | Bevel Solid Wood Base Kit for 54/60"d x 234"w Top Surfaces | \$4,722 |
| 30 | 204 | 27 $\frac{7}{8}$ | 120 | 42 | 65T30240VBW | Bevel Solid Wood Base Kit for 54/60"d x 240"w Top Surfaces | \$4,854 |

Model | **Base Wood**

[see Anthology Solid Wood Finishes](#)

Frame Base Kit

- available in metal powdercoat paint and chrome finishes
- top shapes: Rectangular, Soft Rectangular, Arc Rectangular, Boat, Arc Boat and Racetrack
- planning base specification [ANPG_11](#)
- planning base location [ANPG_18](#)
- planning power guide [ANPG_20- ANPG_40](#)
- magnetic wire manager [page 58](#)

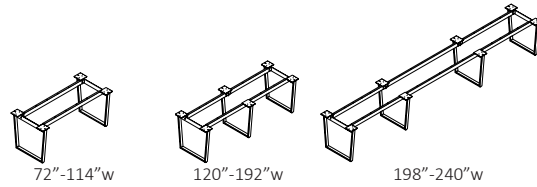

| D | W | H | CTN WT | CU FT | Model | Description | List Price |
|--|-----|------------------|--------|-------|---------------------|--|----------------|
| Frame Base Kit for 36"deep Table | | | | | | | |
| 22 $\frac{7}{8}$ | 48 | 27 $\frac{7}{8}$ | 70 | 11 | 65T1872FRBM | Frame Metal Base Kit for 36"d x 72"w Top Surfaces | \$1,363 |
| 22 $\frac{7}{8}$ | 54 | 27 $\frac{7}{8}$ | 71 | 11 | 65T1878FRBM | Frame Metal Base Kit for 36"d x 78"w Top Surfaces | \$1,369 |
| 22 $\frac{7}{8}$ | 54 | 27 $\frac{7}{8}$ | 71 | 11 | 65T1884FRBM | Frame Metal Base Kit for 36"d x 84"w Top Surfaces | \$1,376 |
| 22 $\frac{7}{8}$ | 60 | 27 $\frac{7}{8}$ | 72 | 11 | 65T1890FRBM | Frame Metal Base Kit for 36"d x 90"w Top Surfaces | \$1,382 |
| 22 $\frac{7}{8}$ | 60 | 27 $\frac{7}{8}$ | 72 | 11 | 65T1896FRBM | Frame Metal Base Kit for 36"d x 96"w Top Surfaces | \$1,388 |
| Frame Base Kit for 42/48"deep Table | | | | | | | |
| 28 $\frac{7}{8}$ | 48 | 27 $\frac{7}{8}$ | 75 | 11 | 65T2472FRBM | Frame Metal Base Kit for 42/48"d x 72"w Top Surfaces | \$1,394 |
| 28 $\frac{7}{8}$ | 54 | 27 $\frac{7}{8}$ | 76 | 11 | 65T2478FRBM | Frame Metal Base Kit for 42/48"d x 78"w Top Surfaces | \$1,400 |
| 28 $\frac{7}{8}$ | 54 | 27 $\frac{7}{8}$ | 76 | 11 | 65T2484FRBM | Frame Metal Base Kit for 42/48"d x 84"w Top Surfaces | \$1,406 |
| 28 $\frac{7}{8}$ | 60 | 27 $\frac{7}{8}$ | 77 | 11 | 65T2490FRBM | Frame Metal Base Kit for 42/48"d x 90"w Top Surfaces | \$1,412 |
| 28 $\frac{7}{8}$ | 60 | 27 $\frac{7}{8}$ | 77 | 11 | 65T2496FRBM | Frame Metal Base Kit for 42/48"d x 96"w Top Surfaces | \$1,412 |
| 28 $\frac{7}{8}$ | 66 | 27 $\frac{7}{8}$ | 78 | 11 | 65T24102FRBM | Frame Metal Base Kit for 42/48"d x 102"w Top Surfaces | \$1,645 |
| 28 $\frac{7}{8}$ | 72 | 27 $\frac{7}{8}$ | 79 | 12 | 65T24108FRBM | Frame Metal Base Kit for 42/48"d x 108"w Top SurfacesL | \$1,879 |
| 28 $\frac{7}{8}$ | 78 | 27 $\frac{7}{8}$ | 80 | 12 | 65T24114FRBM | Frame Metal Base Kit for 42/48"d x 114"w Top Surfaces | \$2,113 |
| 28 $\frac{7}{8}$ | 84 | 27 $\frac{7}{8}$ | 110 | 19 | 65T24120FRBM | Frame Metal Base Kit for 42/48"d x 120"w Top Surfaces | \$2,350 |
| Frame Base Kit for 48"deep Table | | | | | | | |
| 28 $\frac{7}{8}$ | 90 | 27 $\frac{7}{8}$ | 111 | 19 | 65T24126FRBM | Frame Metal Base Kit for 48"d x 126"w Top Surfaces | \$2,354 |
| 28 $\frac{7}{8}$ | 96 | 27 $\frac{7}{8}$ | 112 | 19 | 65T24132FRBM | Frame Metal Base Kit for 48"d x 132"w Top Surfaces | \$2,358 |
| 28 $\frac{7}{8}$ | 102 | 27 $\frac{7}{8}$ | 113 | 19 | 65T24138FRBM | Frame Metal Base Kit for 48"d x 138"w Top Surfaces | \$2,362 |
| 28 $\frac{7}{8}$ | 108 | 27 $\frac{7}{8}$ | 114 | 19 | 65T24144FRBM | Frame Metal Base Kit for 48"d x 144"w Top Surfaces | \$2,366 |
| 28 $\frac{7}{8}$ | 114 | 27 $\frac{7}{8}$ | 116 | 20 | 65T24150FRBM | Frame Metal Base Kit for 48"d x 150"w Top SurfacesL | \$2,380 |
| 28 $\frac{7}{8}$ | 120 | 27 $\frac{7}{8}$ | 117 | 20 | 65T24156FRBM | Frame Metal Base Kit for 48"d x 156"w Top Surfaces | \$2,393 |
| 28 $\frac{7}{8}$ | 126 | 27 $\frac{7}{8}$ | 118 | 20 | 65T24162FRBM | Frame Metal Base Kit for 48"d x 162"w Top Surfaces | \$2,407 |
| 28 $\frac{7}{8}$ | 132 | 27 $\frac{7}{8}$ | 119 | 20 | 65T24168FRBM | Frame Metal Base Kit for 48"d x 168"w Top Surfaces | \$2,420 |
| 28 $\frac{7}{8}$ | 138 | 27 $\frac{7}{8}$ | 120 | 20 | 65T24174FRBM | Frame Metal Base Kit for 48"d x 174"w Top Surfaces | \$2,431 |
| 28 $\frac{7}{8}$ | 144 | 27 $\frac{7}{8}$ | 121 | 20 | 65T24180FRBM | Frame Metal Base Kit for 48"d x 180"w Top Surfaces | \$2,443 |
| 28 $\frac{7}{8}$ | 150 | 27 $\frac{7}{8}$ | 122 | 20 | 65T24186FRBM | Frame Metal Base Kit for 48"d x 186"w Top Surfaces | \$2,454 |
| 28 $\frac{7}{8}$ | 156 | 27 $\frac{7}{8}$ | 123 | 20 | 65T24192FRBM | Frame Metal Base Kit for 48"d x 192"w Top Surfaces | \$2,465 |
| 28 $\frac{7}{8}$ | 162 | 27 $\frac{7}{8}$ | 153 | 26 | 65T24198FRBM | Frame Metal Base Kit for 48"d x 198"w Top Surfaces | \$2,563 |
| 28 $\frac{7}{8}$ | 168 | 27 $\frac{7}{8}$ | 154 | 26 | 65T24204FRBM | Frame Metal Base Kit for 48"d x 204"w Top Surfaces | \$2,661 |
| 28 $\frac{7}{8}$ | 174 | 27 $\frac{7}{8}$ | 155 | 26 | 65T24210FRBM | Frame Metal Base Kit for 48"d x 210"w Top Surfaces | \$2,759 |
| 28 $\frac{7}{8}$ | 180 | 27 $\frac{7}{8}$ | 156 | 26 | 65T24216FRBM | Frame Metal Base Kit for 48"d x 216"w Top Surfaces | \$2,857 |
| 28 $\frac{7}{8}$ | 186 | 27 $\frac{7}{8}$ | 158 | 27 | 65T24222FRBM | Frame Metal Base Kit for 48"d x 222"w Top Surfaces | \$2,955 |
| 28 $\frac{7}{8}$ | 192 | 27 $\frac{7}{8}$ | 159 | 27 | 65T24228FRBM | Frame Metal Base Kit for 48"d x 228"w Top Surfaces | \$3,052 |
| 28 $\frac{7}{8}$ | 198 | 27 $\frac{7}{8}$ | 160 | 27 | 65T24234FRBM | Frame Metal Base Kit for 48"d x 234"w Top Surfaces | \$3,150 |
| 28 $\frac{7}{8}$ | 204 | 27 $\frac{7}{8}$ | 161 | 27 | 65T24240FRBM | Frame Metal Base Kit for 48"d x 240"w Top Surfaces | \$3,250 |

Model Metal Finish

[see Anthology Metal Finishes](#)

Chrome Metal Base Upcharge
 2 bases 72" - 114" - add \$1,937
 3 bases 120" - 192" - add \$2,905
 4 bases 198" - 240" - add \$3,873

Frame Base Kit

- available in metal powdercoat paint and chrome finishes
- top shapes: Rectangular, Soft Rectangular, Arc Rectangular, Boat, Arc Boat and Racetrack
- planning base specification [ANPG_11](#)
- planning base location [ANPG_18](#)
- planning power guide [ANPG_20- ANPG_40](#)
- magnetic wire manager [page 58](#)

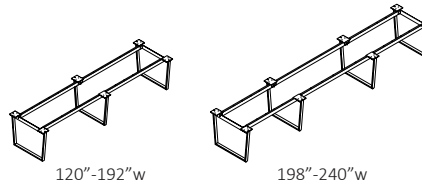

| D | W | H | CTN WT | CU FT | Model | Description | List Price |
|--|-----|------------------|-----------|----------|---------------------|---|----------------|
| Frame Base Kit for 54/60"deep Table | | | | | | | |
| 34 $\frac{7}{8}$ | 84 | 27 $\frac{7}{8}$ | 115 | 22 | 65T30120FRBM | Frame Metal Base Kit for 54/60"d x 120"w Top Surfaces | \$2,458 |
| 34 $\frac{7}{8}$ | 90 | 27 $\frac{7}{8}$ | 116 | 23 | 65T30126FRBM | Frame Metal Base Kit for 54/60"d x 126"w Top Surfaces | \$2,462 |
| 34 $\frac{7}{8}$ | 96 | 27 $\frac{7}{8}$ | 117 | 23 | 65T30132FRBM | Frame Metal Base Kit for 54/60"d x 132"w Top Surfaces | \$2,466 |
| 34 $\frac{7}{8}$ | 102 | 27 $\frac{7}{8}$ | 119 | 23 | 65T30138FRBM | Frame Metal Base Kit for 54/60"d x 138"w Top Surfaces | \$2,470 |
| 34 $\frac{7}{8}$ | 108 | 27 $\frac{7}{8}$ | 120 | 23 | 65T30144FRBM | Frame Metal Base Kit for 54/60"d x 144"w Top Surfaces | \$2,475 |
| 34 $\frac{7}{8}$ | 114 | 27 $\frac{7}{8}$ | 121 | 23 | 65T30150FRBM | Frame Metal Base Kit for 54/60"d x 150"w Top Surfaces | \$2,487 |
| 34 $\frac{7}{8}$ | 120 | 27 $\frac{7}{8}$ | 122 | 23 | 65T30156FRBM | Frame Metal Base Kit for 54/60"d x 156"w Top Surfaces | \$2,499 |
| 34 $\frac{7}{8}$ | 126 | 27 $\frac{7}{8}$ | 123 | 23 | 65T30162FRBM | Frame Metal Base Kit for 54/60"d x 162"w Top Surfaces | \$2,512 |
| 34 $\frac{7}{8}$ | 132 | 27 $\frac{7}{8}$ | 124 | 23 | 65T30168FRBM | Frame Metal Base Kit for 54/60"d x 168"w Top Surfaces | \$2,524 |
| 34 $\frac{7}{8}$ | 138 | 27 $\frac{7}{8}$ | 125 | 23 | 65T30174FRBM | Frame Metal Base Kit for 54/60"d x 174"w Top Surfaces | \$2,536 |
| 34 $\frac{7}{8}$ | 144 | 27 $\frac{7}{8}$ | 126 | 23 | 65T30180FRBM | Frame Metal Base Kit for 54/60"d x 180"w Top Surfaces | \$2,549 |
| 34 $\frac{7}{8}$ | 150 | 27 $\frac{7}{8}$ | 127 | 24 | 65T30186FRBM | Frame Metal Base Kit for 54/60"d x 186"w Top Surfaces | \$2,561 |
| 34 $\frac{7}{8}$ | 156 | 27 $\frac{7}{8}$ | 129 | 24 | 65T30192FRBM | Frame Metal Base Kit for 54/60"d x 192"w Top Surfaces | \$2,573 |
| 34 $\frac{7}{8}$ | 162 | 27 $\frac{7}{8}$ | 160 | 31 | 65T30198FRBM | Frame Metal Base Kit for 54/60"d x 198"w Top Surfaces | \$2,662 |
| 34 $\frac{7}{8}$ | 168 | 27 $\frac{7}{8}$ | 161 | 31 | 65T30204FRBM | Frame Metal Base Kit for 54/60"d x 204"w Top Surfaces | \$2,751 |
| 34 $\frac{7}{8}$ | 174 | 27 $\frac{7}{8}$ | 162 | 31 | 65T30210FRBM | Frame Metal Base Kit for 54/60"d x 210"w Top Surfaces | \$2,839 |
| 34 $\frac{7}{8}$ | 180 | 27 $\frac{7}{8}$ | 164 | 31 | 65T30216FRBM | Frame Metal Base Kit for 54/60"d x 216"w Top Surfaces | \$2,928 |
| 34 $\frac{7}{8}$ | 186 | 27 $\frac{7}{8}$ | 165 | 31 | 65T30222FRBM | Frame Metal Base Kit for 54/60"d x 222"w Top Surfaces | \$3,016 |
| 34 $\frac{7}{8}$ | 192 | 27 $\frac{7}{8}$ | 166 | 31 | 65T30228FRBM | Frame Metal Base Kit for 54/60"d x 228"w Top Surfaces | \$3,105 |
| 34 $\frac{7}{8}$ | 198 | 27 $\frac{7}{8}$ | 167 | 31 | 65T30234FRBM | Frame Metal Base Kit for 54/60"d x 234"w Top Surfaces | \$3,193 |
| 34 $\frac{7}{8}$ | 204 | 27 $\frac{7}{8}$ | 168 | 31 | 65T30240FRBM | Frame Metal Base Kit for 54/60"d x 240"w Top Surfaces | \$3,281 |

| Model | Metal Finish |
|-------|---|
| | see Anthology Metal Finishes Chrome Metal Base Upcharge 2 bases 72" - 114" - add \$1,937 3 bases 120" - 192" - add \$2,905 4 bases 198" - 240" - add \$3,873 |

Frame BridgeLine Base Kit

- available in metal powdercoat paint and chrome finishes
- top shapes: Rectangular, Soft Rectangular, Arc Rectangular, Boat, Arc Boat and Racetrack
- planning base specification [ANPG_12](#)
- planning base location [ANPG_18](#)
- planning power guide [ANPG_20- ANPG_40](#)
- magnetic wire manager [page 58](#)

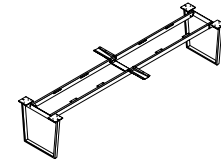

120"-192" w

| D | W | H | CTN WT | CU FT | Model | Description | List Price |
|---|-----|-----|--------|-------|----------------------|--|----------------|
| Frame BridgeLine Base Kit for 48"deep Table | | | | | | | |
| 22 | 84 | 27½ | 106 | 15 | 65T24120FR2BM | Frame BridgeLine Base Kit for 48"d x 120"w Top Surfaces | \$2,140 |
| 23 | 90 | 27½ | 109 | 15 | 65T24126FR2BM | Frame BridgeLine Base Kit for 48"d x 126"w Top Surfaces | \$2,146 |
| 24 | 96 | 27½ | 111 | 16 | 65T24132FR2BM | Frame BridgeLine Base Kit for 48"d x 132"w Top Surfaces | \$2,152 |
| 25 | 102 | 27½ | 114 | 16 | 65T24138FR2BM | Frame BridgeLine Base Kit for 48"d x 138"w Top Surfaces | \$2,158 |
| 26 | 108 | 27½ | 116 | 16 | 65T24144FR2BM | Frame BridgeLine Base Kit for 48"d x 144"w Top Surfaces | \$2,165 |
| 27 | 114 | 27½ | 118 | 16 | 65T24150FR2BM | Frame BridgeLine Base Kit for 48"d x 150"w Top Surfaces | \$2,078 |
| 28 | 120 | 27½ | 121 | 16 | 65T24156FR2BM | Frame BridgeLine Base Kit for 48"d x 156"w Top Surfaces | \$2,177 |
| 29 | 126 | 27½ | 124 | 16 | 65T24162FR2BM | Frame BridgeLine Base Kit for 48"d x 162"w Top Surfaces | \$2,183 |
| 30 | 132 | 27½ | 127 | 17 | 65T24168FR2BM | Frame BridgeLine Base Kit for 48"d x 168"w Top Surfaces | \$2,189 |
| 31 | 138 | 27½ | 129 | 17 | 65T24174FR2BM | Frame BridgeLine Base Kit for 48"d x 174"w Top Surfaces | \$2,195 |
| 32 | 144 | 27½ | 132 | 17 | 65T24180FR2BM | Frame BridgeLine Base Kit for 48"d x 180"w Top Surfaces | \$2,202 |
| 33 | 150 | 27½ | 134 | 17 | 65T24186FR2BM | Frame BridgeLine Base Kit for 48"d x 186"w Top Surfaces | \$2,208 |
| 34 | 156 | 27½ | 137 | 17 | 65T24192FR2BM | Frame BridgeLine Base Kit for 48"d x 192"w Top Surfaces | \$2,214 |
| Frame BridgeLine Base Kit for 54/60"deep Table | | | | | | | |
| 35 | 84 | 27½ | 110 | 17 | 65T30120FR2BM | Frame BridgeLine Base Kit for 54/60"d x 120"w Top Surfaces | \$2,143 |
| 36 | 90 | 27½ | 113 | 18 | 65T30126FR2BM | Frame BridgeLine Base Kit for 54/60"d x 126"w Top Surfaces | \$2,154 |
| 37 | 96 | 27½ | 115 | 18 | 65T30132FR2BM | Frame BridgeLine Base Kit for 54/60"d x 132"w Top Surfaces | \$2,166 |
| 38 | 102 | 27½ | 118 | 18 | 65T30138FR2BM | Frame BridgeLine Base Kit for 54/60"d x 138"w Top Surfaces | \$2,176 |
| 39 | 108 | 27½ | 120 | 18 | 65T30144FR2BM | Frame BridgeLine Base Kit for 54/60"d x 144"w Top Surfaces | \$2,187 |
| 40 | 114 | 27½ | 123 | 18 | 65T30150FR2BM | Frame BridgeLine Base Kit for 54/60"d x 150"w Top Surfaces | \$2,199 |
| 41 | 120 | 27½ | 125 | 18 | 65T30156FR2BM | Frame BridgeLine Base Kit for 54/60"d x 156"w Top Surfaces | \$2,210 |
| 42 | 126 | 27½ | 129 | 19 | 65T30162FR2BM | Frame BridgeLine Base Kit for 54/60"d x 162"w Top Surfaces | \$2,221 |
| 43 | 132 | 27½ | 131 | 19 | 65T30168FR2BM | Frame BridgeLine Base Kit for 54/60"d x 168"w Top Surfaces | \$2,233 |
| 44 | 138 | 27½ | 133 | 19 | 65T30174FR2BM | Frame BridgeLine Base Kit for 54/60"d x 174"w Top Surfaces | \$2,244 |
| 45 | 144 | 27½ | 136 | 19 | 65T30180FR2BM | Frame BridgeLine Base Kit for 54/60"d x 180"w Top Surfaces | \$2,254 |
| 46 | 150 | 27½ | 138 | 19 | 65T30186FR2BM | Frame BridgeLine Base Kit for 54/60"d x 186"w Top Surfaces | \$2,264 |
| 47 | 156 | 27½ | 141 | 19 | 65T30192FR2BM | Frame BridgeLine Base Kit for 54/60"d x 192"w Top Surfaces | \$2,275 |

| Model | Metal Finish |
|-------|--|
| | see Anthology Metal Finishes |
| | Chrome Metal Base Upcharge 2 bases 120" - 192" - add \$1,880 |

Oblique Base Kit

- available in metal standard and additional powdercoat finishes
- top shapes: Rectangular, Soft Rectangular, Arc Rectangular, Boat, Arc Boat and Racetrack
- planning base specification [ANPG_13](#)
- planning base location [ANPG_18](#)
- planning power guide [ANPG_20- ANPG_40](#)

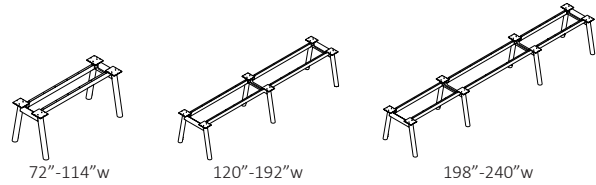

| D | W | H | CTN WT | CU FT | Model | Description | List Price |
|--|-----|-----|--------|-------|---------------------|--|----------------|
| Oblique Base Kit for 36/42"deep Table | | | | | | | |
| 27 | 48 | 27½ | 80 | 12 | 65T2472QUBM | Oblique Metal Base Kit for 36/42"d x 72"w Top Surfaces | \$1,484 |
| 27 | 54 | 27½ | 81 | 12 | 65T2478QUBM | Oblique Metal Base Kit for 36/42"d x 78"w Top Surfaces | \$1,487 |
| 27 | 54 | 27½ | 81 | 12 | 65T2484QUBM | Oblique Metal Base Kit for 36/42"d x 84"w Top Surfaces | \$1,490 |
| 27 | 60 | 27½ | 82 | 12 | 65T2490QUBM | Oblique Metal Base Kit for 36/42"d x 90"w Top Surfaces | \$1,492 |
| 27 | 60 | 27½ | 82 | 12 | 65T2496QUBM | Oblique Metal Base Kit for 36/42"d x 96"w Top Surfaces | \$1,496 |
| Oblique Base Kit for 42"deep Table | | | | | | | |
| 27 | 66 | 27½ | 83 | 13 | 65T24102QUBM | Oblique Metal Base Kit for 42"d x 102"w Top Surfaces | \$1,499 |
| 27 | 72 | 27½ | 85 | 13 | 65T24108QUBM | Oblique Metal Base Kit for 42"d x 108"w Top Surfaces | \$1,502 |
| 27 | 78 | 27½ | 86 | 13 | 65T24114QUBM | Oblique Metal Base Kit for 42"d x 114"w Top Surfaces | \$1,505 |
| 27 | 84 | 27½ | 118 | 18 | 65T24120QUBM | Oblique Metal Base Kit for 42"d x 120"w Top Surfaces | \$2,340 |
| Oblique Base Kit for 48"deep Table | | | | | | | |
| 33 | 48 | 27½ | 85 | 14 | 65T3072QUBM | Oblique Metal Base Kit for 48"d x 72"w Top Surfaces | \$1,506 |
| 33 | 54 | 27½ | 86 | 15 | 65T3078QUBM | Oblique Metal Base Kit for 48"d x 78"w Top Surfaces | \$1,509 |
| 33 | 54 | 27½ | 86 | 15 | 65T3084QUBM | Oblique Metal Base Kit for 48"d x 84"w Top Surfaces | \$1,513 |
| 33 | 60 | 27½ | 87 | 15 | 65T3090QUBM | Oblique Metal Base Kit for 48"d x 90"w Top Surfaces | \$1,515 |
| 33 | 60 | 27½ | 87 | 15 | 65T3096QUBM | Oblique Metal Base Kit for 48"d x 96"w Top Surfaces | \$1,517 |
| 33 | 66 | 27½ | 88 | 15 | 65T30102QUBM | Oblique Metal Base Kit for 48"d x 102"w Top Surfaces | \$1,520 |
| 33 | 72 | 27½ | 89 | 15 | 65T30108QUBM | Oblique Metal Base Kit for 48"d x 108"w Top Surfaces | \$1,523 |
| 33 | 78 | 27½ | 90 | 15 | 65T30114QUBM | Oblique Metal Base Kit for 48"d x 114"w Top Surfaces | \$1,526 |
| 33 | 84 | 27½ | 125 | 21 | 65T30120QUBM | Oblique Metal Base Kit for 48"d x 120"w Top Surfaces | \$2,361 |
| 33 | 90 | 27½ | 126 | 21 | 65T30126QUBM | Oblique Metal Base Kit for 48"d x 126"w Top Surfaces | \$2,365 |
| 33 | 96 | 27½ | 127 | 21 | 65T30132QUBM | Oblique Metal Base Kit for 48"d x 132"w Top Surfaces | \$2,368 |
| 33 | 102 | 27½ | 129 | 21 | 65T30138QUBM | Oblique Metal Base Kit for 48"d x 138"w Top Surfaces | \$2,373 |
| 33 | 108 | 27½ | 130 | 21 | 65T30144QUBM | Oblique Metal Base Kit for 48"d x 144"w Top Surfaces | \$2,376 |
| 33 | 114 | 27½ | 131 | 22 | 65T30150QUBM | Oblique Metal Base Kit for 48"d x 150"w Top Surfaces | \$2,392 |
| 33 | 120 | 27½ | 132 | 22 | 65T30156QUBM | Oblique Metal Base Kit for 48"d x 156"w Top Surfaces | \$2,408 |
| 33 | 126 | 27½ | 133 | 22 | 65T30162QUBM | Oblique Metal Base Kit for 48"d x 162"w Top Surfaces | \$2,424 |
| 33 | 132 | 27½ | 134 | 22 | 65T30168QUBM | Oblique Metal Base Kit for 48"d x 168"w Top Surfaces | \$2,441 |
| 33 | 138 | 27½ | 135 | 22 | 65T30174QUBM | Oblique Metal Base Kit for 48"d x 174"w Top Surfaces | \$2,456 |
| 33 | 144 | 27½ | 136 | 22 | 65T30180QUBM | Oblique Metal Base Kit for 48"d x 180"w Top Surfaces | \$2,472 |
| 33 | 150 | 27½ | 137 | 22 | 65T30186QUBM | Oblique Metal Base Kit for 48"d x 186"w Top Surfaces | \$2,488 |
| 33 | 156 | 27½ | 139 | 22 | 65T30192QUBM | Oblique Metal Base Kit for 48"d x 192"w Top Surfaces | \$2,504 |
| 33 | 162 | 27½ | 173 | 28 | 65T30198QUBM | Oblique Metal Base Kit for 48"d x 198"w Top Surfaces | \$3,257 |
| 33 | 168 | 27½ | 175 | 28 | 65T30204QUBM | Oblique Metal Base Kit for 48"d x 204"w Top Surfaces | \$3,261 |
| 33 | 174 | 27½ | 176 | 29 | 65T30210QUBM | Oblique Metal Base Kit for 48"d x 210"w Top Surfaces | \$3,266 |
| 33 | 180 | 27½ | 177 | 29 | 65T30216QUBM | Oblique Metal Base Kit for 48"d x 216"w Top Surfaces | \$3,274 |
| 33 | 186 | 27½ | 178 | 29 | 65T30222QUBM | Oblique Metal Base Kit for 48"d x 222"w Top Surfaces | \$3,278 |
| 33 | 192 | 27½ | 179 | 29 | 65T30228QUBM | Oblique Metal Base Kit for 48"d x 228"w Top Surfaces | \$3,282 |
| 33 | 198 | 27½ | 180 | 29 | 65T30234QUBM | Oblique Metal Base Kit for 48"d x 234"w Top Surfaces | \$3,286 |
| 33 | 204 | 27½ | 181 | 29 | 65T30240QUBM | Oblique Metal Base Kit for 48"d x 240"w Top Surfaces | \$3,290 |

| Model | Metal Frame |
|-------|--|
| | <p>Standard Metal Frame Colors see Anthology Standard Metal Frame Colors</p> <p>Additional Metal Frame Colors see Anthology Additional Metal Frame Colors</p> <p>Additional Metal Frame Colors Upcharge 2 bases 72" - 114" - add \$194 3 bases 120" - 192" - add \$281 4 bases 198" - 240" - add \$374</p> |

Oblique Base Kit

- available in metal standard and additional powdercoat finishes
- top shapes: Rectangular, Soft Rectangular, Arc Rectangular, Boat, Arc Boat and Racetrack
- planning base specification [ANPG_13](#)
- planning base location [ANPG_18](#)
- planning power guide [ANPG_20- ANPG_40](#)

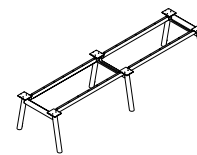

120"-192"w

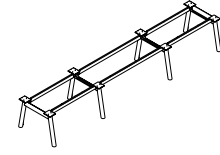

198"-240"w

| D | W | H | CTN WT | CU FT | Model | Description | List Price |
|--|-----|------------------|--------|-------|---------------------|---|----------------|
| Oblique Base Kit for 54/60"deep Table | | | | | | | |
| 39 | 84 | 27 $\frac{7}{8}$ | 132 | 24 | 65T36120QUBM | Oblique Metal Base Kit for 54/60"d x 120"w Top Surfaces | \$2,450 |
| 39 | 90 | 27 $\frac{7}{8}$ | 133 | 24 | 65T36126QUBM | Oblique Metal Base Kit for 54/60"d x 126"w Top Surfaces | \$2,454 |
| 39 | 96 | 27 $\frac{7}{8}$ | 134 | 24 | 65T36132QUBM | Oblique Metal Base Kit for 54/60"d x 132"w Top Surfaces | \$2,458 |
| 39 | 102 | 27 $\frac{7}{8}$ | 136 | 25 | 65T36138QUBM | Oblique Metal Base Kit for 54/60"d x 138"w Top Surfaces | \$2,462 |
| 39 | 108 | 27 $\frac{7}{8}$ | 137 | 25 | 65T36144QUBM | Oblique Metal Base Kit for 54/60"d x 144"w Top Surfaces | \$2,466 |
| 39 | 114 | 27 $\frac{7}{8}$ | 138 | 25 | 65T36150QUBM | Oblique Metal Base Kit for 54/60"d x 150"w Top Surfaces | \$2,480 |
| 39 | 120 | 27 $\frac{7}{8}$ | 139 | 25 | 65T36156QUBM | Oblique Metal Base Kit for 54/60"d x 156"w Top Surfaces | \$2,494 |
| 39 | 126 | 27 $\frac{7}{8}$ | 140 | 25 | 65T36162QUBM | Oblique Metal Base Kit for 54/60"d x 162"w Top Surfaces | \$2,508 |
| 39 | 132 | 27 $\frac{7}{8}$ | 141 | 25 | 65T36168QUBM | Oblique Metal Base Kit for 54/60"d x 168"w Top Surfaces | \$2,521 |
| 39 | 138 | 27 $\frac{7}{8}$ | 142 | 25 | 65T36174QUBM | Oblique Metal Base Kit for 54/60"d x 174"w Top Surfaces | \$2,534 |
| 39 | 144 | 27 $\frac{7}{8}$ | 143 | 25 | 65T36180QUBM | Oblique Metal Base Kit for 54/60"d x 180"w Top Surfaces | \$2,549 |
| 39 | 150 | 27 $\frac{7}{8}$ | 145 | 26 | 65T36186QUBM | Oblique Metal Base Kit for 54/60"d x 186"w Top Surfaces | \$2,562 |
| 39 | 156 | 27 $\frac{7}{8}$ | 146 | 26 | 65T36192QUBM | Oblique Metal Base Kit for 54/60"d x 192"w Top Surfaces | \$2,575 |
| 39 | 162 | 27 $\frac{7}{8}$ | 183 | 33 | 65T36198QUBM | Oblique Metal Base Kit for 54/60"d x 198"w Top Surfaces | \$3,290 |
| 39 | 168 | 27 $\frac{7}{8}$ | 184 | 33 | 65T36204QUBM | Oblique Metal Base Kit for 54/60"d x 204"w Top Surfaces | \$3,294 |
| 39 | 174 | 27 $\frac{7}{8}$ | 185 | 33 | 65T36210QUBM | Oblique Metal Base Kit for 54/60"d x 210"w Top Surfaces | \$3,299 |
| 39 | 180 | 27 $\frac{7}{8}$ | 186 | 33 | 65T36216QUBM | Oblique Metal Base Kit for 54/60"d x 216"w Top Surfaces | \$3,303 |
| 39 | 186 | 27 $\frac{7}{8}$ | 187 | 33 | 65T36222QUBM | Oblique Metal Base Kit for 54/60"d x 222"w Top Surfaces | \$3,307 |
| 39 | 192 | 27 $\frac{7}{8}$ | 188 | 33 | 65T36228QUBM | Oblique Metal Base Kit for 54/60"d x 228"w Top Surfaces | \$3,311 |
| 39 | 198 | 27 $\frac{7}{8}$ | 190 | 33 | 65T36234QUBM | Oblique Metal Base Kit for 54/60"d x 234"w Top Surfaces | \$3,315 |
| 39 | 204 | 27 $\frac{7}{8}$ | 191 | 34 | 65T36240QUBM | Oblique Metal Base Kit for 54/60"d x 240"w Top Surfaces | \$3,319 |

| Model | Metal Frame |
|-------|--|
| | <p>Standard Metal Frame Colors see Anthology Standard Metal Frame Colors</p> <p>Additional Metal Frame Colors see Anthology Additional Metal Frame Colors</p> <p>Additional Metal Frame Colors Upcharge 2 bases 72" - 114" - add \$194 3 bases 120" - 192" - add \$281 4 bases 198" - 240" - add \$374</p> |

Outline Base Kit

- available in TFL and Veneer surfaces with powdercoat or chrome metal accent trim
- top shapes: Rectangular, Soft Rectangular, Arc Rectangular, Boat, Arc Boat and Racetrack
- planning base specification [ANPG_14](#)
- planning base location [ANPG_18](#)
- planning power guide [ANPG_20- ANPG_40](#)

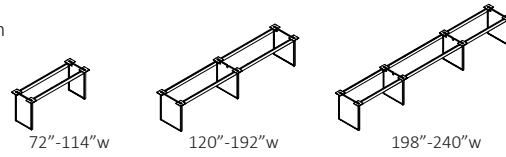

| D | W | H | CTN WT | CU FT | ① Model | Description | TFL Laminate T | ESS Veneer V | ART Veneer V |
|---|-----|-----|--------|-------|---------------------|---|----------------|----------------|----------------|
| Outline Base Kit for 36" deep Table | | | | | | | | | |
| 18 | 48 | 27½ | 45 | 10 | 65T1872ULB_ | Outline Metal Base Kit for 36"d x 72"w Top Surfaces | \$1,617 | \$2,245 | \$2,469 |
| 18 | 54 | 27½ | 46 | 11 | 65T1878ULB_ | Outline Metal Base Kit for 36"d x 78"w Top Surfaces | \$1,632 | \$2,256 | \$2,482 |
| 18 | 54 | 27½ | 46 | 11 | 65T1884ULB_ | Outline Metal Base Kit for 36"d x 84"w Top Surfaces | \$1,647 | \$2,268 | \$2,494 |
| 18 | 60 | 27½ | 47 | 11 | 65T1890ULB_ | Outline Metal Base Kit for 36"d x 90"w Top Surfaces | \$1,663 | \$2,279 | \$2,506 |
| 18 | 54 | 27½ | 46 | 11 | 65T1896ULB_ | Outline Metal Base Kit for 36"d x 96"w Top Surfaces | \$1,678 | \$2,290 | \$2,519 |
| Outline Base Kit for 42/48" deep Table | | | | | | | | | |
| 24 | 48 | 27½ | 46 | 13 | 65T2472ULB_ | Outline Metal Base Kit for 42/48"d x 72"w Top Surfaces | \$1,696 | \$2,302 | \$2,531 |
| 24 | 54 | 27½ | 47 | 13 | 65T2478ULB_ | Outline Metal Base Kit for 42/48"d x 78"w Top Surfaces | \$1,712 | \$2,312 | \$2,543 |
| 24 | 54 | 27½ | 47 | 13 | 65T2484ULB_ | Outline Metal Base Kit for 42/48"d x 84"w Top Surfaces | \$1,729 | \$2,322 | \$2,554 |
| 24 | 60 | 27½ | 48 | 13 | 65T2490ULB_ | Outline Metal Base Kit for 42/48"d x 90"w Top Surfaces | \$1,745 | \$2,332 | \$2,565 |
| 24 | 60 | 27½ | 48 | 13 | 65T2496ULB_ | Outline Metal Base Kit for 42/48"d x 96"w Top Surfaces | \$1,763 | \$2,344 | \$2,579 |
| 24 | 66 | 27½ | 49 | 13 | 65T24102ULB_ | Outline Metal Base Kit for 42/48"d x 102"w Top Surfaces | \$2,066 | \$2,752 | \$3,027 |
| 24 | 72 | 27½ | 50 | 13 | 65T24108ULB_ | Outline Metal Base Kit for 42/48"d x 108"w Top Surfaces | \$2,368 | \$3,160 | \$3,476 |
| 24 | 78 | 27½ | 51 | 13 | 65T24114ULB_ | Outline Metal Base Kit for 42/48"d x 114"w Top Surfaces | \$2,670 | \$3,567 | \$3,924 |
| 24 | 84 | 27½ | 70 | 18 | 65T24120ULB_ | Outline Metal Base Kit for 42/48"d x 120"w Top Surfaces | \$2,972 | \$3,975 | \$4,373 |
| Outline Base Kit for 48" deep Table | | | | | | | | | |
| 24 | 90 | 27½ | 72 | 18 | 65T24126ULB_ | Outline Metal Base Kit for 48"d x 126"w Top Surfaces | \$2,981 | \$3,987 | \$4,385 |
| 24 | 96 | 27½ | 73 | 19 | 65T24132ULB_ | Outline Metal Base Kit for 48"d x 132"w Top Surfaces | \$2,991 | \$3,998 | \$4,398 |
| 24 | 102 | 27½ | 74 | 19 | 65T24138ULB_ | Outline Metal Base Kit for 48"d x 138"w Top Surfaces | \$3,000 | \$4,009 | \$4,410 |
| 24 | 108 | 27½ | 75 | 19 | 65T24144ULB_ | Outline Metal Base Kit for 48"d x 144"w Top Surfaces | \$3,010 | \$4,021 | \$4,422 |
| 24 | 114 | 27½ | 76 | 19 | 65T24150ULB_ | Outline Metal Base Kit for 48"d x 150"w Top Surfaces | \$3,019 | \$4,032 | \$4,435 |
| 24 | 120 | 27½ | 77 | 19 | 65T24156ULB_ | Outline Metal Base Kit for 48"d x 156"w Top Surfaces | \$3,029 | \$4,043 | \$4,448 |
| 24 | 126 | 27½ | 78 | 19 | 65T24162ULB_ | Outline Metal Base Kit for 48"d x 162"w Top Surfaces | \$3,038 | \$4,055 | \$4,460 |
| 24 | 132 | 27½ | 79 | 19 | 65T24168ULB_ | Outline Metal Base Kit for 48"d x 168"w Top Surfaces | \$3,048 | \$4,066 | \$4,473 |
| 24 | 138 | 27½ | 80 | 19 | 65T24174ULB_ | Outline Metal Base Kit for 48"d x 174"w Top Surfaces | \$3,059 | \$4,077 | \$4,485 |
| 24 | 144 | 27½ | 82 | 19 | 65T24180ULB_ | Outline Metal Base Kit for 48"d x 180"w Top Surfaces | \$3,068 | \$4,089 | \$4,497 |
| 24 | 150 | 27½ | 83 | 20 | 65T24186ULB_ | Outline Metal Base Kit for 48"d x 186"w Top Surfaces | \$3,077 | \$4,100 | \$4,510 |
| 24 | 156 | 27½ | 84 | 20 | 65T24192ULB_ | Outline Metal Base Kit for 48"d x 192"w Top Surfaces | \$3,087 | \$4,112 | \$4,523 |
| 24 | 162 | 27½ | 95 | 25 | 65T24198ULB_ | Outline Metal Base Kit for 48"d x 198"w Top Surfaces | \$3,211 | \$4,295 | \$4,724 |
| 24 | 168 | 27½ | 96 | 25 | 65T24204ULB_ | Outline Metal Base Kit for 48"d x 204"w Top Surfaces | \$3,335 | \$4,478 | \$4,926 |
| 24 | 174 | 27½ | 97 | 25 | 65T24210ULB_ | Outline Metal Base Kit for 48"d x 210"w Top Surfaces | \$3,458 | \$4,660 | \$5,126 |
| 24 | 180 | 27½ | 98 | 25 | 65T24216ULB_ | Outline Metal Base Kit for 48"d x 216"w Top Surfaces | \$3,582 | \$4,843 | \$5,327 |
| 24 | 186 | 27½ | 99 | 25 | 65T24222ULB_ | Outline Metal Base Kit for 48"d x 222"w Top Surfaces | \$3,705 | \$5,026 | \$5,529 |
| 24 | 192 | 27½ | 101 | 25 | 65T24228ULB_ | Outline Metal Base Kit for 48"d x 228"w Top Surfaces | \$3,829 | \$5,208 | \$5,729 |
| 24 | 198 | 27½ | 102 | 26 | 65T24234ULB_ | Outline Metal Base Kit for 48"d x 234"w Top Surfaces | \$3,953 | \$5,390 | \$5,929 |
| 24 | 204 | 27½ | 103 | 26 | 65T24240ULB_ | Outline Metal Base Kit for 48"d x 240"w Top Surfaces | \$4,077 | \$5,574 | \$6,131 |

| Model | Laminate | Veneer | Metal Finish |
|-------|--|--|---|
| | see Anthology Laminate Selection | see Anthology Veneer Selection | see Anthology Metal Finishes Chrome Metal Base Upcharge 2 bases 72" - 114" - add \$2,009 3 bases 120" - 192" - add \$3,013 4 bases 198" - 240" - add \$4,017 |

Outline Base Kit

- available in TFL and Veneer surfaces with powdercoat or chrome metal accent trim
- top shapes: Rectangular, Soft Rectangular, Arc Rectangular, Boat, Arc Boat and Racetrack
- planning base specification [ANPG_14](#)
- planning base location [ANPG_18](#)
- planning power guide [ANPG_20- ANPG_40](#)

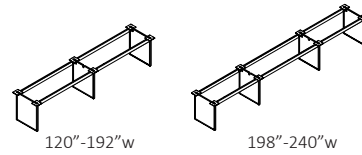

| D | W | H | CTN WT | CU FT | ① Model | Description | TFL Laminate T | ESS Veneer V | ART Veneer V |
|--|-----|------------------|--------|-------|---------------------|---|----------------|----------------|----------------|
| Outline Base Kit for 54/60"deep Table | | | | | | | | | |
| 30 | 84 | 27 $\frac{7}{8}$ | 74 | 22 | 65T30120ULB_ | Outline Metal Base Kit for 54/60"d x 120"w Top Surfaces | \$3,027 | \$4,055 | \$4,460 |
| 30 | 90 | 27 $\frac{7}{8}$ | 75 | 22 | 65T30126ULB_ | Outline Metal Base Kit for 54/60"d x 126"w Top Surfaces | \$3,036 | \$4,066 | \$4,473 |
| 30 | 96 | 27 $\frac{7}{8}$ | 76 | 22 | 65T30132ULB_ | Outline Metal Base Kit for 54/60"d x 132"w Top Surfaces | \$3,045 | \$4,077 | \$4,485 |
| 30 | 102 | 27 $\frac{7}{8}$ | 77 | 22 | 65T30138ULB_ | Outline Metal Base Kit for 54/60"d x 138"w Top Surfaces | \$3,054 | \$4,089 | \$4,497 |
| 30 | 108 | 27 $\frac{7}{8}$ | 78 | 22 | 65T30144ULB_ | Outline Metal Base Kit for 54/60"d x 144"w Top Surfaces | \$3,065 | \$4,101 | \$4,511 |
| 30 | 114 | 27 $\frac{7}{8}$ | 80 | 22 | 65T30150ULB_ | Outline Metal Base Kit for 54/60"d x 150"w Top Surfaces | \$3,074 | \$4,112 | \$4,523 |
| 30 | 120 | 27 $\frac{7}{8}$ | 81 | 22 | 65T30156ULB_ | Outline Metal Base Kit for 54/60"d x 156"w Top Surfaces | \$3,083 | \$4,124 | \$4,536 |
| 30 | 126 | 27 $\frac{7}{8}$ | 82 | 22 | 65T30162ULB_ | Outline Metal Base Kit for 54/60"d x 162"w Top Surfaces | \$3,093 | \$4,135 | \$4,548 |
| 30 | 132 | 27 $\frac{7}{8}$ | 83 | 22 | 65T30168ULB_ | Outline Metal Base Kit for 54/60"d x 168"w Top Surfaces | \$3,103 | \$4,146 | \$4,561 |
| 30 | 138 | 27 $\frac{7}{8}$ | 84 | 22 | 65T30174ULB_ | Outline Metal Base Kit for 54/60"d x 174"w Top Surfaces | \$3,112 | \$4,158 | \$4,574 |
| 30 | 144 | 27 $\frac{7}{8}$ | 85 | 22 | 65T30180ULB_ | Outline Metal Base Kit for 54/60"d x 180"w Top Surfaces | \$3,121 | \$4,169 | \$4,586 |
| 30 | 150 | 27 $\frac{7}{8}$ | 86 | 23 | 65T30186ULB_ | Outline Metal Base Kit for 54/60"d x 186"w Top Surfaces | \$3,131 | \$4,180 | \$4,598 |
| 30 | 156 | 27 $\frac{7}{8}$ | 87 | 23 | 65T30192ULB_ | Outline Metal Base Kit for 54/60"d x 192"w Top Surfaces | \$3,141 | \$4,192 | \$4,611 |
| 30 | 162 | 27 $\frac{7}{8}$ | 100 | 29 | 65T30198ULB_ | Outline Metal Base Kit for 54/60"d x 198"w Top Surfaces | \$3,266 | \$4,375 | \$4,813 |
| 30 | 168 | 27 $\frac{7}{8}$ | 101 | 29 | 65T30204ULB_ | Outline Metal Base Kit for 54/60"d x 204"w Top Surfaces | \$3,390 | \$4,559 | \$5,016 |
| 30 | 174 | 27 $\frac{7}{8}$ | 102 | 29 | 65T30210ULB_ | Outline Metal Base Kit for 54/60"d x 210"w Top Surfaces | \$3,515 | \$4,743 | \$5,216 |
| 30 | 180 | 27 $\frac{7}{8}$ | 103 | 29 | 65T30216ULB_ | Outline Metal Base Kit for 54/60"d x 216"w Top Surfaces | \$3,639 | \$4,927 | \$5,419 |
| 30 | 186 | 27 $\frac{7}{8}$ | 104 | 30 | 65T30222ULB_ | Outline Metal Base Kit for 54/60"d x 222"w Top Surfaces | \$3,764 | \$5,110 | \$5,621 |
| 30 | 192 | 27 $\frac{7}{8}$ | 105 | 30 | 65T30228ULB_ | Outline Metal Base Kit for 54/60"d x 228"w Top Surfaces | \$3,889 | \$5,295 | \$5,824 |
| 30 | 198 | 27 $\frac{7}{8}$ | 106 | 30 | 65T30234ULB_ | Outline Metal Base Kit for 54/60"d x 234"w Top Surfaces | \$4,013 | \$5,479 | \$6,027 |
| 30 | 204 | 27 $\frac{7}{8}$ | 108 | 30 | 65T30240ULB_ | Outline Metal Base Kit for 54/60"d x 240"w Top Surfaces | \$4,138 | \$5,662 | \$6,229 |

| Model | Laminate | Veneer | Metal Finish |
|-------|--|--|--|
| | see Anthology Laminate Selection | see Anthology Veneer Selection | see Anthology Metal Finishes Chrome Metal Base Upcharge 2 bases 72" - 114" - add \$2,009 3 bases 120" - 192" - add \$3,013 4 bases 198" - 240" - add \$4,017 |

Racetrack Base Kit

- available in HPL and Veneer surfaces
- top shapes: Rectangular, Soft Rectangular, Arc Rectangular, Boat, Arc Boat and Racetrack
- planning base specification [ANPG_15](#)
- planning base location [ANPG_18](#)
- planning power guide [ANPG_20- ANPG_40](#)

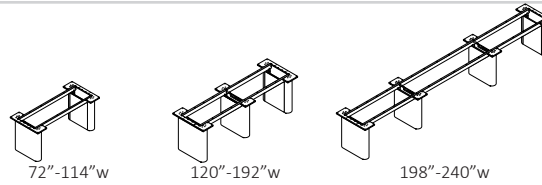

| D | W | H | CTN WT | CU FT | ① Model | Description | HPL Laminate H | ESS Veneer V | ART Veneer V |
|--|-----|-----|--------|-------|---------------------|---|----------------|--------------|--------------|
| Racetrack Base Kit for 36"deep Table | | | | | | | | | |
| 18 | 48 | 27½ | 87 | 11 | 65T1872RKB_ | Racetrack Base Kit for 36"d x 72"w Top Surfaces | \$5,733 | \$5,925 | \$6,518 |
| 18 | 54 | 27½ | 87 | 11 | 65T1878RKB_ | Racetrack Base Kit for 36"d x 78"w Top Surfaces | \$5,738 | \$5,929 | \$6,522 |
| 18 | 54 | 27½ | 87 | 11 | 65T1884RKB_ | Racetrack Base Kit for 36"d x 84"w Top Surfaces | \$5,742 | \$5,933 | \$6,527 |
| 18 | 60 | 27½ | 99 | 12 | 65T1890RKB_ | Racetrack Base Kit for 36"d x 90"w Top Surfaces | \$5,746 | \$5,937 | \$6,532 |
| 18 | 60 | 27½ | 99 | 12 | 65T1896RKB_ | Racetrack Base Kit for 36"d x 96"w Top Surfaces | \$5,750 | \$5,942 | \$6,536 |
| Racetrack Base Kit for 42/48"deep Table | | | | | | | | | |
| 24 | 48 | 27½ | 102 | 13 | 65T2472RKB_ | Racetrack Base Kit for 42/48"d x 72"w Top Surfaces | \$5,969 | \$6,103 | \$6,714 |
| 24 | 54 | 27½ | 102 | 13 | 65T2478RKB_ | Racetrack Base Kit for 42/48"d x 78"w Top Surfaces | \$6,039 | \$6,193 | \$6,813 |
| 24 | 54 | 27½ | 103 | 13 | 65T2484RKB_ | Racetrack Base Kit for 42/48"d x 84"w Top Surfaces | \$6,109 | \$6,281 | \$6,910 |
| 24 | 60 | 27½ | 103 | 14 | 65T2490RKB_ | Racetrack Base Kit for 42/48"d x 90"w Top Surfaces | \$6,179 | \$6,370 | \$7,008 |
| 24 | 60 | 27½ | 104 | 14 | 65T2496RKB_ | Racetrack Base Kit for 42/48"d x 96"w Top Surfaces | \$6,250 | \$6,459 | \$7,104 |
| 24 | 66 | 27½ | 104 | 15 | 65T24102RKB_ | Racetrack Base Kit for 42/48"d x 102"w Top Surfaces | \$6,343 | \$6,578 | \$7,236 |
| 24 | 72 | 27½ | 105 | 15 | 65T24108RKB_ | Racetrack Base Kit for 42/48"d x 108"w Top Surfaces | \$6,436 | \$6,697 | \$7,367 |
| 24 | 78 | 27½ | 105 | 15 | 65T24114RKB_ | Racetrack Base Kit for 42/48"d x 114"w Top Surfaces | \$6,529 | \$6,815 | \$7,497 |
| 24 | 84 | 27½ | 140 | 20 | 65T24120RKB_ | Racetrack Base Kit for 42/48"d x 120"w Top Surfaces | \$10,504 | \$11,028 | \$12,131 |
| Racetrack Base Kit for 48"deep Table | | | | | | | | | |
| 24 | 90 | 27½ | 140 | 20 | 65T24126RKB_ | Racetrack Base Kit for 48"d x 126"w Top Surfaces | \$10,510 | \$11,032 | \$12,135 |
| 24 | 96 | 27½ | 140 | 20 | 65T24132RKB_ | Racetrack Base Kit for 48"d x 132"w Top Surfaces | \$10,513 | \$11,038 | \$12,142 |
| 24 | 102 | 27½ | 143 | 20 | 65T24138RKB_ | Racetrack Base Kit for 48"d x 138"w Top Surfaces | \$10,517 | \$11,044 | \$12,149 |
| 24 | 108 | 27½ | 143 | 21 | 65T24144RKB_ | Racetrack Base Kit for 48"d x 144"w Top Surfaces | \$10,520 | \$11,050 | \$12,156 |
| 24 | 114 | 27½ | 143 | 21 | 65T24150RKB_ | Racetrack Base Kit for 48"d x 150"w Top Surfaces | \$10,524 | \$11,053 | \$12,160 |
| 24 | 120 | 27½ | 143 | 21 | 65T24156RKB_ | Racetrack Base Kit for 48"d x 156"w Top Surfaces | \$10,528 | \$11,060 | \$12,166 |
| 24 | 126 | 27½ | 145 | 22 | 65T24162RKB_ | Racetrack Base Kit for 48"d x 162"w Top Surfaces | \$10,531 | \$11,066 | \$12,173 |
| 24 | 132 | 27½ | 145 | 22 | 65T24168RKB_ | Racetrack Base Kit for 48"d x 168"w Top Surfaces | \$10,534 | \$11,072 | \$12,179 |
| 24 | 138 | 27½ | 145 | 22 | 65T24174RKB_ | Racetrack Base Kit for 48"d x 174"w Top Surfaces | \$10,538 | \$11,078 | \$12,186 |
| 24 | 144 | 27½ | 147 | 23 | 65T24180RKB_ | Racetrack Base Kit for 48"d x 180"w Top Surfaces | \$10,543 | \$11,084 | \$12,194 |
| 24 | 150 | 27½ | 147 | 23 | 65T24186RKB_ | Racetrack Base Kit for 48"d x 186"w Top Surfaces | \$10,546 | \$11,091 | \$12,200 |
| 24 | 156 | 27½ | 147 | 23 | 65T24192RKB_ | Racetrack Base Kit for 48"d x 192"w Top Surfaces | \$10,550 | \$11,097 | \$12,207 |
| 24 | 162 | 27½ | 196 | 29 | 65T24198RKB_ | Racetrack Base Kit for 48"d x 198"w Top Surfaces | \$13,519 | \$14,426 | \$15,869 |
| 24 | 168 | 27½ | 220 | 29 | 65T24204RKB_ | Racetrack Base Kit for 48"d x 204"w Top Surfaces | \$13,524 | \$14,431 | \$15,874 |
| 24 | 174 | 27½ | 220 | 29 | 65T24210RKB_ | Racetrack Base Kit for 48"d x 210"w Top Surfaces | \$13,530 | \$14,436 | \$15,880 |
| 24 | 180 | 27½ | 225 | 30 | 65T24216RKB_ | Racetrack Base Kit for 48"d x 216"w Top Surfaces | \$13,535 | \$14,441 | \$15,885 |
| 24 | 186 | 27½ | 225 | 30 | 65T24222RKB_ | Racetrack Base Kit for 48"d x 222"w Top Surfaces | \$13,540 | \$14,446 | \$15,891 |
| 24 | 192 | 27½ | 230 | 30 | 65T24228RKB_ | Racetrack Base Kit for 48"d x 228"w Top Surfaces | \$13,545 | \$14,462 | \$15,908 |
| 24 | 198 | 27½ | 230 | 31 | 65T24234RKB_ | Racetrack Base Kit for 48"d x 234"w Top Surfaces | \$13,550 | \$14,457 | \$15,903 |
| 24 | 204 | 27½ | 235 | 31 | 65T24240RKB_ | Racetrack Base Kit for 48"d x 240"w Top Surfaces | \$13,555 | \$14,565 | \$16,021 |

| Model | Laminate | Veneer |
|-------|---|---|
| | see Anthology Laminate Finishes | see Anthology Veneer Finishes |

Racetrack Base Kit

- available in HPL and Veneer surfaces
- top shapes: Rectangular, Soft Rectangular, Arc Rectangular, Boat, Arc Boat and Racetrack
- planning base specification [ANPG_15](#)
- planning base location [ANPG_18](#)
- planning power guide [ANPG_20- ANPG_40](#)

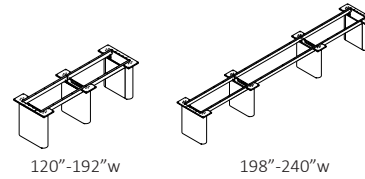

| D | W | H | CTN WT | CU FT | ① Model | Description | HPL Laminate H | ESS Veneer V | ART Veneer V |
|--|-----|------------------|-----------|----------|---------------------|---|----------------------|--------------------|--------------------|
| Racetrack Base Kit for 54/60"deep Table | | | | | | | | | |
| 30 | 84 | 27 $\frac{7}{8}$ | 154 | 32 | 65T30120RKB_ | Racetrack Base Kit for 54/60"d x 120"w Top Surfaces | \$11,351 | \$11,448 | \$12,593 |
| 30 | 90 | 27 $\frac{7}{8}$ | 154 | 32 | 65T30126RKB_ | Racetrack Base Kit for 54/60"d x 126"w Top Surfaces | \$11,356 | \$11,455 | \$12,602 |
| 30 | 96 | 27 $\frac{7}{8}$ | 154 | 32 | 65T30132RKB_ | Racetrack Base Kit for 54/60"d x 132"w Top Surfaces | \$11,361 | \$11,460 | \$12,607 |
| 30 | 102 | 27 $\frac{7}{8}$ | 157 | 33 | 65T30138RKB_ | Racetrack Base Kit for 54/60"d x 138"w Top Surfaces | \$11,367 | \$11,466 | \$12,614 |
| 30 | 108 | 27 $\frac{7}{8}$ | 157 | 33 | 65T30144RKB_ | Racetrack Base Kit for 54/60"d x 144"w Top Surfaces | \$11,372 | \$11,472 | \$12,619 |
| 30 | 114 | 27 $\frac{7}{8}$ | 157 | 33 | 65T30150RKB_ | Racetrack Base Kit for 54/60"d x 150"w Top Surfaces | \$11,423 | \$11,476 | \$12,624 |
| 30 | 120 | 27 $\frac{7}{8}$ | 157 | 34 | 65T30156RKB_ | Racetrack Base Kit for 54/60"d x 156"w Top Surfaces | \$11,475 | \$11,482 | \$12,630 |
| 30 | 126 | 27 $\frac{7}{8}$ | 159 | 34 | 65T30162RKB_ | Racetrack Base Kit for 54/60"d x 162"w Top Surfaces | \$11,526 | \$11,488 | \$12,638 |
| 30 | 132 | 27 $\frac{7}{8}$ | 159 | 34 | 65T30168RKB_ | Racetrack Base Kit for 54/60"d x 168"w Top Surfaces | \$11,578 | \$11,493 | \$12,643 |
| 30 | 138 | 27 $\frac{7}{8}$ | 159 | 35 | 65T30174RKB_ | Racetrack Base Kit for 54/60"d x 174"w Top Surfaces | \$11,629 | \$11,499 | \$12,650 |
| 30 | 144 | 27 $\frac{7}{8}$ | 161 | 35 | 65T30180RKB_ | Racetrack Base Kit for 54/60"d x 180"w Top Surfaces | \$11,681 | \$11,506 | \$12,656 |
| 30 | 150 | 27 $\frac{7}{8}$ | 161 | 35 | 65T30186RKB_ | Racetrack Base Kit for 54/60"d x 186"w Top Surfaces | \$11,732 | \$11,511 | \$12,662 |
| 30 | 156 | 27 $\frac{7}{8}$ | 161 | 36 | 65T30192RKB_ | Racetrack Base Kit for 54/60"d x 192"w Top Surfaces | \$11,784 | \$11,517 | \$12,669 |
| 30 | 162 | 27 $\frac{7}{8}$ | 196 | 36 | 65T30198RKB_ | Racetrack Base Kit for 54/60"d x 198"w Top Surfaces | \$15,661 | \$16,707 | \$18,378 |
| 30 | 168 | 27 $\frac{7}{8}$ | 220 | 36 | 65T30204RKB_ | Racetrack Base Kit for 54/60"d x 204"w Top Surfaces | \$15,666 | \$16,712 | \$18,384 |
| 30 | 174 | 27 $\frac{7}{8}$ | 220 | 37 | 65T30210RKB_ | Racetrack Base Kit for 54/60"d x 210"w Top Surfaces | \$15,671 | \$16,717 | \$18,389 |
| 30 | 180 | 27 $\frac{7}{8}$ | 225 | 37 | 65T30216RKB_ | Racetrack Base Kit for 54/60"d x 216"w Top Surfaces | \$15,676 | \$16,723 | \$18,395 |
| 30 | 186 | 27 $\frac{7}{8}$ | 225 | 37 | 65T30222RKB_ | Racetrack Base Kit for 54/60"d x 222"w Top Surfaces | \$15,681 | \$16,728 | \$18,400 |
| 30 | 192 | 27 $\frac{7}{8}$ | 244 | 38 | 65T30228RKB_ | Racetrack Base Kit for 54/60"d x 228"w Top Surfaces | \$15,686 | \$16,733 | \$18,407 |
| 30 | 198 | 27 $\frac{7}{8}$ | 244 | 38 | 65T30234RKB_ | Racetrack Base Kit for 54/60"d x 234"w Top Surfaces | \$15,692 | \$16,738 | \$18,412 |
| 30 | 204 | 27 $\frac{7}{8}$ | 249 | 38 | 65T30240RKB_ | Racetrack Base Kit for 54/60"d x 240"w Top Surfaces | \$15,697 | \$16,743 | \$18,418 |

| Model | Laminate | Veneer |
|-------|---|---|
| | see Anthology Laminate Finishes | see Anthology Veneer Finishes |

Racetrack BridgeLine Base Kit

- available in HPL and Veneer surfaces
- top shapes: Rectangular, Soft Rectangular, Arc Rectangular, Boat, Arc Boat and Racetrack
- planning base specification [ANPG_16](#)
- planning base location [ANPG_18](#)
- planning power guide [ANPG_20- ANPG_40](#)

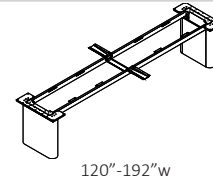

| D | W | H | CTN WT | CU FT | ① Model | Description | HPL Laminate H | ESS Veneer V | ART Veneer V |
|---|-----|-----|-----------|----------|----------------------|--|----------------------|--------------------|--------------------|
| Racetrack BridgeLine Base Kit for 48"deep Table | | | | | | | | | |
| 24 | 84 | 27% | 154 | 18 | 65T24120RK2B_ | Racetrack BridgeLine Base Kit for 48"d x 120"w Top Surfaces | \$7,345 | \$7,546 | \$8,301 |
| 24 | 90 | 27% | 156 | 18 | 65T24126RK2B_ | Racetrack BridgeLine Base Kit for 48"d x 126"w Top Surfaces | \$7,355 | \$7,556 | \$8,312 |
| 24 | 96 | 27% | 158 | 18 | 65T24132RK2B_ | Racetrack BridgeLine Base Kit for 48"d x 132"w Top Surfaces | \$7,364 | \$7,564 | \$8,321 |
| 24 | 102 | 27% | 161 | 19 | 65T24138RK2B_ | Racetrack BridgeLine Base Kit for 48"d x 138"w Top Surfaces | \$7,373 | \$7,572 | \$8,330 |
| 24 | 108 | 27% | 163 | 19 | 65T24144RK2B_ | Racetrack BridgeLine Base Kit for 48"d x 144"w Top Surfaces | \$7,381 | \$7,582 | \$8,341 |
| 24 | 114 | 27% | 166 | 19 | 65T24150RK2B_ | Racetrack BridgeLine Base Kit for 48"d x 150"w Top Surfaces | \$7,395 | \$7,594 | \$8,354 |
| 24 | 120 | 27% | 168 | 19 | 65T24156RK2B_ | Racetrack BridgeLine Base Kit for 48"d x 156"w Top Surfaces | \$7,406 | \$7,605 | \$8,366 |
| 24 | 126 | 27% | 171 | 19 | 65T24162RK2B_ | Racetrack BridgeLine Base Kit for 48"d x 162"w Top Surfaces | \$7,418 | \$7,617 | \$8,380 |
| 24 | 132 | 27% | 174 | 19 | 65T24168RK2B_ | Racetrack BridgeLine Base Kit for 48"d x 168"w Top Surfaces | \$7,430 | \$7,629 | \$8,392 |
| 24 | 138 | 27% | 177 | 20 | 65T24174RK2B_ | Racetrack BridgeLine Base Kit for 48"d x 174"w Top Surfaces | \$7,441 | \$7,642 | \$8,406 |
| 24 | 144 | 27% | 179 | 20 | 65T24180RK2B_ | Racetrack BridgeLine Base Kit for 48"d x 180"w Top Surfaces | \$7,454 | \$7,653 | \$8,419 |
| 24 | 150 | 27% | 182 | 20 | 65T24186RK2B_ | Racetrack BridgeLine Base Kit for 48"d x 186"w Top Surfaces | \$7,465 | \$7,666 | \$8,433 |
| 24 | 156 | 27% | 184 | 20 | 65T24192RK2B_ | Racetrack BridgeLine Base Kit for 48"d x 192"w Top Surfaces | \$7,477 | \$7,677 | \$8,445 |
| Racetrack BridgeLine Base Kit for 54/60"deep Table | | | | | | | | | |
| 30 | 84 | 27% | 179 | 21 | 65T30120RK2B_ | Racetrack BridgeLine Base Kit for 54/60"d x 120"w Top Surfaces | \$7,694 | \$7,950 | \$8,745 |
| 30 | 90 | 27% | 182 | 21 | 65T30126RK2B_ | Racetrack BridgeLine Base Kit for 54/60"d x 126"w Top Surfaces | \$7,728 | \$7,984 | \$8,783 |
| 30 | 96 | 27% | 184 | 21 | 65T30132RK2B_ | Racetrack BridgeLine Base Kit for 54/60"d x 132"w Top Surfaces | \$7,761 | \$8,017 | \$8,819 |
| 30 | 102 | 27% | 187 | 21 | 65T30138RK2B_ | Racetrack BridgeLine Base Kit for 54/60"d x 138"w Top Surfaces | \$7,793 | \$8,051 | \$8,856 |
| 30 | 108 | 27% | 189 | 22 | 65T30144RK2B_ | Racetrack BridgeLine Base Kit for 54/60"d x 144"w Top Surfaces | \$7,827 | \$8,084 | \$8,892 |
| 30 | 114 | 27% | 192 | 22 | 65T30150RK2B_ | Racetrack BridgeLine Base Kit for 54/60"d x 150"w Top Surfaces | \$7,845 | \$8,102 | \$8,913 |
| 30 | 120 | 27% | 194 | 22 | 65T30156RK2B_ | Racetrack BridgeLine Base Kit for 54/60"d x 156"w Top Surfaces | \$7,862 | \$8,120 | \$8,933 |
| 30 | 126 | 27% | 197 | 22 | 65T30162RK2B_ | Racetrack BridgeLine Base Kit for 54/60"d x 162"w Top Surfaces | \$7,880 | \$8,136 | \$8,950 |
| 30 | 132 | 27% | 200 | 22 | 65T30168RK2B_ | Racetrack BridgeLine Base Kit for 54/60"d x 168"w Top Surfaces | \$7,896 | \$8,154 | \$8,970 |
| 30 | 138 | 27% | 202 | 22 | 65T30174RK2B_ | Racetrack BridgeLine Base Kit for 54/60"d x 174"w Top Surfaces | \$7,914 | \$8,171 | \$8,989 |
| 30 | 144 | 27% | 205 | 23 | 65T30180RK2B_ | Racetrack BridgeLine Base Kit for 54/60"d x 180"w Top Surfaces | \$7,931 | \$8,188 | \$9,007 |
| 30 | 150 | 27% | 207 | 23 | 65T30186RK2B_ | Racetrack BridgeLine Base Kit for 54/60"d x 186"w Top Surfaces | \$7,948 | \$8,205 | \$9,026 |
| 30 | 156 | 27% | 210 | 23 | 65T30192RK2B_ | Racetrack BridgeLine Base Kit for 54/60"d x 192"w Top Surfaces | \$7,965 | \$8,222 | \$9,045 |

| Model | Laminate | Veneer |
|-------|---|---|
| | see Anthology Laminate Finishes | see Anthology Veneer Finishes |

Conical Single Base

- available in HPL and Veneer surfaces
- top shape: Round
- specify 20" base for 36" and 42" tops
- specify 24" base for 48", 54" and 60" tops
- planning base specification [ANPG_9](#)
- planning power guide [ANPG_20- ANPG_40](#)

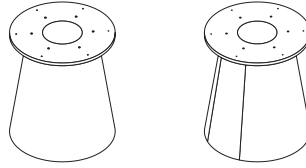

| D | W | H | CTN WT | CU FT | ① Model | Description | HPL Laminate H | ESS Veneer V | ART Veneer V |
|-----------------------------------|----|------------------|-----------|----------|---------------------|----------------------------|----------------------|--------------------|--------------------|
| Conical Single Base | | | | | | | | | |
| 20 | 20 | 27 $\frac{7}{8}$ | 144 | 10 | 65T2028CNB_ | Conical Single Base | \$4,260 | \$4,901 | \$5,392 |
| 24 | 24 | 27 $\frac{7}{8}$ | 114 | 13 | 65T2428CNB_ | Conical Single Base | \$4,632 | \$5,239 | \$5,763 |
| Conical Single Access Base | | | | | | | | | |
| 20 | 20 | 27 $\frac{7}{8}$ | 144 | 10 | 65T2028CNAB_ | Conical Single Access Base | \$4,920 | \$5,560 | \$6,117 |
| 24 | 24 | 27 $\frac{7}{8}$ | 114 | 13 | 65T2428CNAB_ | Conical Single Access Base | \$5,366 | \$5,972 | \$6,570 |

| Model | Laminate | Veneer |
|-------|---|---|
| | see Anthology Laminate Finishes | see Anthology Veneer Finishes |

Conical Base Kit

- available in HPL and Veneer surfaces
- top shapes: Rectangular, Soft Rectangular, Arc Rectangular, Boat, Arc Boat and Racetrack
- planning base specification [ANPG_9](#)
- planning base location [ANPG_19](#)
- planning power guide [ANPG_20- ANPG_40](#)

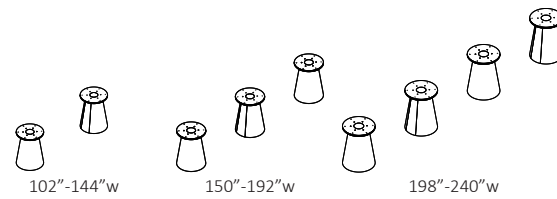

| D | W | H | CTN WT | CU FT | ① Model | Description | HPL Laminate H | ESS Veneer V | ART Veneer V |
|--|-----|------------------|--------|-------|---------------------|---|-----------------|-----------------|-----------------|
| Conical Base Kit for 42/48"deep Table | | | | | | | | | |
| 20 | 68 | 27 $\frac{7}{8}$ | 271 | 20 | 65T20102CNB_ | Conical Base Kit for 42/48"d x 102"w Top Surfaces | \$10,094 | \$11,134 | \$12,247 |
| 20 | 74 | 27 $\frac{7}{8}$ | 271 | 20 | 65T20108CNB_ | Conical Base Kit for 42/48"d x 108"w Top Surfaces | \$10,094 | \$11,134 | \$12,247 |
| 20 | 80 | 27 $\frac{7}{8}$ | 271 | 20 | 65T20114CNB_ | Conical Base Kit for 42/48"d x 114"w Top Surfaces | \$10,094 | \$11,134 | \$12,247 |
| 20 | 86 | 27 $\frac{7}{8}$ | 291 | 20 | 65T20120CNB_ | Conical Base Kit for 42/48"d x 120"w Top Surfaces | \$10,094 | \$11,134 | \$12,247 |
| Conical Base Kit for 48"deep Table | | | | | | | | | |
| 20 | 92 | 27 $\frac{7}{8}$ | 291 | 22 | 65T20126CNB_ | Conical Base Kit for 42"d x 126"w Top Surfaces | \$10,253 | \$11,292 | \$12,422 |
| 20 | 98 | 27 $\frac{7}{8}$ | 291 | 22 | 65T20132CNB_ | Conical Base Kit for 42"d x 132"w Top Surfaces | \$10,253 | \$11,292 | \$12,422 |
| 20 | 104 | 27 $\frac{7}{8}$ | 291 | 22 | 65T20138CNB_ | Conical Base Kit for 42"d x 138"w Top Surfaces | \$10,253 | \$11,292 | \$12,422 |
| 20 | 110 | 27 $\frac{7}{8}$ | 291 | 22 | 65T20144CNB_ | Conical Base Kit for 42"d x 144"w Top Surfaces | \$10,253 | \$11,292 | \$12,422 |
| 20 | 116 | 27 $\frac{7}{8}$ | 261 | 30 | 65T20150CNB_ | Conical Base Kit for 42"d x 150"w Top Surfaces | \$14,702 | \$16,067 | \$17,674 |
| 20 | 122 | 27 $\frac{7}{8}$ | 261 | 30 | 65T20156CNB_ | Conical Base Kit for 42"d x 156"w Top Surfaces | \$14,702 | \$16,067 | \$17,674 |
| 20 | 128 | 27 $\frac{7}{8}$ | 261 | 30 | 65T20162CNB_ | Conical Base Kit for 42"d x 162"w Top Surfaces | \$14,702 | \$16,067 | \$17,674 |
| 20 | 134 | 27 $\frac{7}{8}$ | 261 | 30 | 65T20168CNB_ | Conical Base Kit for 42"d x 168"w Top Surfaces | \$14,702 | \$16,067 | \$17,674 |
| 20 | 140 | 27 $\frac{7}{8}$ | 261 | 30 | 65T20174CNB_ | Conical Base Kit for 42"d x 174"w Top Surfaces | \$14,702 | \$16,067 | \$17,674 |
| 20 | 146 | 27 $\frac{7}{8}$ | 281 | 32 | 65T20180CNB_ | Conical Base Kit for 42"d x 180"w Top Surfaces | \$14,980 | \$16,345 | \$17,979 |
| 20 | 152 | 27 $\frac{7}{8}$ | 281 | 32 | 65T20186CNB_ | Conical Base Kit for 42"d x 186"w Top Surfaces | \$14,980 | \$16,345 | \$17,979 |
| 20 | 158 | 27 $\frac{7}{8}$ | 281 | 32 | 65T20192CNB_ | Conical Base Kit for 42"d x 192"w Top Surfaces | \$14,980 | \$16,345 | \$17,979 |
| 20 | 164 | 27 $\frac{7}{8}$ | 298 | 52 | 65T20198CNB_ | Conical Base Kit for 42"d x 198"w Top Surfaces | \$20,043 | \$21,735 | \$23,909 |
| 20 | 170 | 27 $\frac{7}{8}$ | 298 | 52 | 65T20204CNB_ | Conical Base Kit for 42"d x 204"w Top Surfaces | \$20,043 | \$21,735 | \$23,909 |
| 20 | 176 | 27 $\frac{7}{8}$ | 298 | 52 | 65T20210CNB_ | Conical Base Kit for 42"d x 210"w Top Surfaces | \$20,043 | \$21,735 | \$23,909 |
| 20 | 182 | 27 $\frac{7}{8}$ | 298 | 52 | 65T20216CNB_ | Conical Base Kit for 42"d x 216"w Top Surfaces | \$20,043 | \$21,735 | \$23,909 |
| 20 | 188 | 27 $\frac{7}{8}$ | 318 | 54 | 65T20222CNB_ | Conical Base Kit for 42"d x 222"w Top Surfaces | \$20,438 | \$22,129 | \$24,342 |
| 20 | 194 | 27 $\frac{7}{8}$ | 318 | 54 | 65T20228CNB_ | Conical Base Kit for 42"d x 228"w Top Surfaces | \$20,438 | \$22,129 | \$24,342 |
| 20 | 200 | 27 $\frac{7}{8}$ | 318 | 54 | 65T20234CNB_ | Conical Base Kit for 42"d x 234"w Top Surfaces | \$20,438 | \$22,129 | \$24,342 |
| 20 | 206 | 27 $\frac{7}{8}$ | 318 | 54 | 65T20240CNB_ | Conical Base Kit for 42"d x 240"w Top Surfaces | \$20,438 | \$22,129 | \$24,342 |

| Model | Laminate | Veneer |
|-------|---|---|
| | see Anthology Laminate Finishes | see Anthology Veneer Finishes |

Conical Base Kit

- available in HPL and Veneer surfaces
- top shapes: Rectangular, Soft Rectangular, Arc Rectangular, Boat, Arc Boat and Racetrack
- planning base specification [ANPG_9](#)
- planning base location [ANPG_19](#)
- planning power guide [ANPG_20- ANPG_40](#)

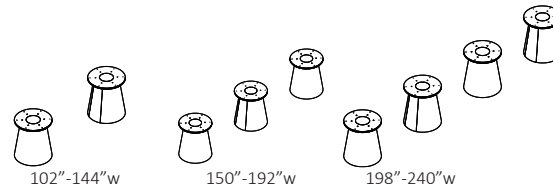

| D | W | H | CTN WT | CU FT | ① Model | Description | HPL Laminate H | ESS Veneer V | ART Veneer V |
|--|-----|------------------|--------|-------|---------------------|---|-----------------|-----------------|-----------------|
| Conical Base Kit for 54/60"deep Table | | | | | | | | | |
| 24 | 90 | 27 $\frac{7}{8}$ | 78 | 26 | 65T24120CNB_ | Conical Base Kit for 54/60"d x 120"w Top Surfaces | \$10,966 | \$11,929 | \$13,123 |
| 24 | 96 | 27 $\frac{7}{8}$ | 98 | 28 | 65T24126CNB_ | Conical Base Kit for 54/60"d x 126"w Top Surfaces | \$11,124 | \$12,088 | \$13,297 |
| 24 | 102 | 27 $\frac{7}{8}$ | 98 | 28 | 65T24132CNB_ | Conical Base Kit for 54/60"d x 132"w Top Surfaces | \$11,124 | \$12,088 | \$13,297 |
| 24 | 108 | 27 $\frac{7}{8}$ | 98 | 28 | 65T24138CNB_ | Conical Base Kit for 54/60"d x 138"w Top Surfaces | \$11,124 | \$12,088 | \$13,297 |
| 24 | 114 | 27 $\frac{7}{8}$ | 98 | 28 | 65T24144CNB_ | Conical Base Kit for 54/60"d x 144"w Top Surfaces | \$11,124 | \$12,088 | \$13,297 |
| 24 | 120 | 27 $\frac{7}{8}$ | 117 | 39 | 65T24150CNB_ | Conical Base Kit for 54/60"d x 150"w Top Surfaces | \$15,996 | \$17,248 | \$18,973 |
| 24 | 126 | 27 $\frac{7}{8}$ | 117 | 39 | 65T24156CNB_ | Conical Base Kit for 54/60"d x 156"w Top Surfaces | \$15,003 | \$17,248 | \$18,973 |
| 24 | 132 | 27 $\frac{7}{8}$ | 117 | 39 | 65T24162CNB_ | Conical Base Kit for 54/60"d x 162"w Top Surfaces | \$15,003 | \$17,248 | \$18,973 |
| 24 | 138 | 27 $\frac{7}{8}$ | 117 | 39 | 65T24168CNB_ | Conical Base Kit for 54/60"d x 168"w Top Surfaces | \$15,003 | \$17,248 | \$18,973 |
| 24 | 144 | 27 $\frac{7}{8}$ | 117 | 39 | 65T24174CNB_ | Conical Base Kit for 54/60"d x 174"w Top Surfaces | \$15,003 | \$17,248 | \$18,973 |
| 24 | 150 | 27 $\frac{7}{8}$ | 137 | 41 | 65T24180CNB_ | Conical Base Kit for 54/60"d x 180"w Top Surfaces | \$16,274 | \$17,526 | \$19,279 |
| 24 | 156 | 27 $\frac{7}{8}$ | 137 | 41 | 65T24186CNB_ | Conical Base Kit for 54/60"d x 186"w Top Surfaces | \$16,274 | \$17,526 | \$19,279 |
| 24 | 162 | 27 $\frac{7}{8}$ | 137 | 41 | 65T24192CNB_ | Conical Base Kit for 54/60"d x 192"w Top Surfaces | \$16,274 | \$17,526 | \$19,279 |
| 24 | 168 | 27 $\frac{7}{8}$ | 152 | 52 | 65T24198CNB_ | Conical Base Kit for 54/60"d x 198"w Top Surfaces | \$21,844 | \$23,441 | \$25,786 |
| 24 | 174 | 27 $\frac{7}{8}$ | 152 | 52 | 65T24204CNB_ | Conical Base Kit for 54/60"d x 204"w Top Surfaces | \$21,844 | \$23,441 | \$25,786 |
| 24 | 180 | 27 $\frac{7}{8}$ | 152 | 52 | 65T24210CNB_ | Conical Base Kit for 54/60"d x 210"w Top Surfaces | \$21,844 | \$23,441 | \$25,786 |
| 24 | 186 | 27 $\frac{7}{8}$ | 152 | 52 | 65T24216CNB_ | Conical Base Kit for 54/60"d x 216"w Top Surfaces | \$21,844 | \$23,441 | \$25,786 |
| 24 | 192 | 27 $\frac{7}{8}$ | 172 | 54 | 65T24222CNB_ | Conical Base Kit for 54/60"d x 222"w Top Surfaces | \$22,237 | \$23,777 | \$26,155 |
| 24 | 198 | 27 $\frac{7}{8}$ | 172 | 54 | 65T24228CNB_ | Conical Base Kit for 54/60"d x 228"w Top Surfaces | \$22,237 | \$23,777 | \$26,155 |
| 24 | 204 | 27 $\frac{7}{8}$ | 172 | 54 | 65T24234CNB_ | Conical Base Kit for 54/60"d x 234"w Top Surfaces | \$22,237 | \$23,777 | \$26,155 |
| 24 | 210 | 27 $\frac{7}{8}$ | 172 | 54 | 65T24240CNB_ | Conical Base Kit for 54/60"d x 240"w Top Surfaces | \$22,237 | \$23,777 | \$26,155 |

| Model | Laminate | Veneer |
|-------|---|---|
| | see Anthology Laminate Finishes | see Anthology Veneer Finishes |

Fluted Cylinder Single Base

- available in fluted solid wood
- top shape: Round
- specify 19" base for 36" and 42" tops
- specify 24" base for 48", 54" and 60" tops
- planning base specification [ANPG_10](#)
- planning power guide [ANPG_20- ANPG_40](#)

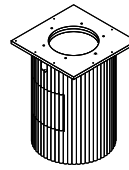
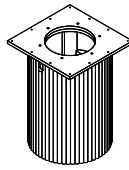

| D | W | H | CTN WT | CU FT | Model | Description | List Price |
|---|-----|-----|-----------|----------|----------------------|--------------------------------------|----------------|
| Fluted Cylinder Single Base | | | | | | | |
| 19½ | 19½ | 27⅞ | 142 | 10 | 65T1828FCYBW | Fluted Solid Wood Single Base | \$7,995 |
| 24½ | 24½ | 27⅞ | 129 | 13 | 65T2428FCYBW | Fluted Solid Wood Single Base | \$9,244 |
| Fluted Cylinder Single Access Base | | | | | | | |
| 19½ | 19½ | 27⅞ | 142 | 10 | 65T1828FCYABW | Fluted Solid Wood Single Access Base | \$8,730 |
| 24½ | 24½ | 27⅞ | 129 | 13 | 65T2428FCYABW | Fluted Solid Wood Single Access Base | \$9,977 |

| Model | Base Wood |
|-------|---|
| | see Anthology Solid Wood Finishes |

Fluted Cylinder Base Kit

- available in fluted solid wood
- top shapes: Rectangular, Soft Rectangular, Arc Rectangular, Boat, Arc Boat and Racetrack
- planning base specification [ANPG_10](#)
- planning base location [ANPG_19](#)
- planning power guide [ANPG_20- ANPG_40](#)

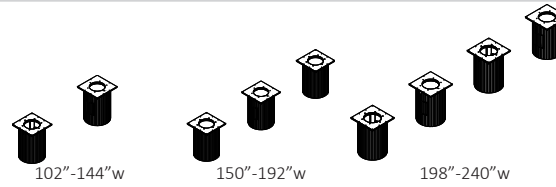

| D | W | H | CTN WT | CU FT | Model | Description | List Price |
|---|----------|---------|--------|-------|----------------------|---|-----------------|
| Fluted Cylinder Base Kit for 42/48" deep Table | | | | | | | |
| 19 1/8" | 67 1/8" | 27 7/8" | 218 | 20 | 65T18102FCYBW | Fluted Cylinder Base Kit for 42/48"d x 102"w Top Surfaces | \$16,281 |
| 19 1/8" | 73 1/8" | 27 7/8" | 218 | 20 | 65T18108FCYBW | Fluted Cylinder Base Kit for 42/48"d x 108"w Top Surfaces | \$16,281 |
| 19 1/8" | 79 1/8" | 27 7/8" | 218 | 20 | 65T18114FCYBW | Fluted Cylinder Base Kit for 42/48"d x 114"w Top Surfaces | \$16,281 |
| 19 1/8" | 85 1/8" | 27 7/8" | 218 | 20 | 65T18120FCYBW | Fluted Cylinder Base Kit for 42/48"d x 120"w Top Surfaces | \$16,281 |
| Fluted Cylinder Base Kit for 48" deep Table | | | | | | | |
| 19 1/8" | 91 1/8" | 27 7/8" | 238 | 20 | 65T18126FCYBW | Fluted Cylinder Base Kit for 48"d x 126"w Top Surfaces | \$16,423 |
| 19 1/8" | 97 1/8" | 27 7/8" | 238 | 22 | 65T18132FCYBW | Fluted Cylinder Base Kit for 48"d x 132"w Top Surfaces | \$16,423 |
| 19 1/8" | 103 1/8" | 27 7/8" | 238 | 22 | 65T18138FCYBW | Fluted Cylinder Base Kit for 48"d x 138"w Top Surfaces | \$16,423 |
| 19 1/8" | 109 1/8" | 27 7/8" | 238 | 22 | 65T18144FCYBW | Fluted Cylinder Base Kit for 48"d x 144"w Top Surfaces | \$16,423 |
| 19 1/8" | 115 1/8" | 27 7/8" | 327 | 30 | 65T18150FCYBW | Fluted Cylinder Base Kit for 48"d x 150"w Top Surfaces | \$23,814 |
| 19 1/8" | 121 1/8" | 27 7/8" | 327 | 30 | 65T18156FCYBW | Fluted Cylinder Base Kit for 48"d x 156"w Top Surfaces | \$23,814 |
| 19 1/8" | 127 1/8" | 27 7/8" | 327 | 30 | 65T18162FCYBW | Fluted Cylinder Base Kit for 48"d x 162"w Top Surfaces | \$23,814 |
| 19 1/8" | 133 1/8" | 27 7/8" | 327 | 30 | 65T18168FCYBW | Fluted Cylinder Base Kit for 48"d x 168"w Top Surfaces | \$23,814 |
| 19 1/8" | 139 1/8" | 27 7/8" | 327 | 30 | 65T18174FCYBW | Fluted Cylinder Base Kit for 48"d x 174"w Top Surfaces | \$23,814 |
| 19 1/8" | 145 1/8" | 27 7/8" | 347 | 32 | 65T18180FCYBW | Fluted Cylinder Base Kit for 48"d x 180"w Top Surfaces | \$24,063 |
| 19 1/8" | 151 1/8" | 27 7/8" | 347 | 32 | 65T18186FCYBW | Fluted Cylinder Base Kit for 48"d x 186"w Top Surfaces | \$24,063 |
| 19 1/8" | 157 1/8" | 27 7/8" | 347 | 32 | 65T18192FCYBW | Fluted Cylinder Base Kit for 48"d x 192"w Top Surfaces | \$24,063 |
| 19 1/8" | 163 1/8" | 27 7/8" | 328 | 40 | 65T18198FCYBW | Fluted Cylinder Base Kit for 48"d x 198"w Top Surfaces | \$32,135 |
| 19 1/8" | 169 1/8" | 27 7/8" | 328 | 40 | 65T18204FCYBW | Fluted Cylinder Base Kit for 48"d x 204"w Top Surfaces | \$32,135 |
| 19 1/8" | 175 1/8" | 27 7/8" | 328 | 40 | 65T18210FCYBW | Fluted Cylinder Base Kit for 48"d x 210"w Top Surfaces | \$32,135 |
| 19 1/8" | 181 1/8" | 27 7/8" | 328 | 40 | 65T18216FCYBW | Fluted Cylinder Base Kit for 48"d x 216"w Top Surfaces | \$32,135 |
| 19 1/8" | 187 1/8" | 27 7/8" | 348 | 42 | 65T18222FCYBW | Fluted Cylinder Base Kit for 48"d x 222"w Top Surfaces | \$32,490 |
| 19 1/8" | 193 1/8" | 27 7/8" | 348 | 42 | 65T18228FCYBW | Fluted Cylinder Base Kit for 48"d x 228"w Top Surfaces | \$32,490 |
| 19 1/8" | 199 1/8" | 27 7/8" | 348 | 42 | 65T18234FCYBW | Fluted Cylinder Base Kit for 48"d x 234"w Top Surfaces | \$32,490 |
| 19 1/8" | 205 1/8" | 27 7/8" | 348 | 42 | 65T18240FCYBW | Fluted Cylinder Base Kit for 48"d x 240"w Top Surfaces | \$32,490 |

Model Base Wood

[see Anthology Solid Wood Finishes](#)

Fluted Cylinder Base Kit

- available in fluted solid wood
- top shapes: Rectangular, Soft Rectangular, Arc Rectangular, Boat, Arc Boat and Racetrack
- planning base specification [ANPG_10](#)
- planning base location [ANPG_19](#)
- planning power guide [ANPG_20- ANPG_40](#)

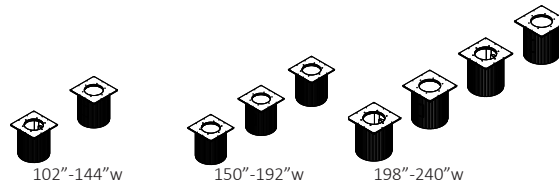

| D | W | H | CTN WT | CU FT | Model | Description | List Price |
|--|------|-----|--------|-------|----------------------|---|-----------------|
| Fluted Cylinder Base Kit for 54/60"deep Table | | | | | | | |
| 24% | 90% | 27% | 78 | 26 | 65T24120FCYBW | Fluted Cylinder Base Kit for 54/60"d x 120"w Top Surfaces | \$18,740 |
| 24% | 96% | 27% | 98 | 28 | 65T24126FCYBW | Fluted Cylinder Base Kit for 54/60"d x 126"w Top Surfaces | \$18,883 |
| 24% | 102% | 27% | 98 | 28 | 65T24132FCYBW | Fluted Cylinder Base Kit for 54/60"d x 132"w Top Surfaces | \$18,883 |
| 24% | 108% | 27% | 98 | 28 | 65T24138FCYBW | Fluted Cylinder Base Kit for 54/60"d x 138"w Top Surfaces | \$18,883 |
| 24% | 114% | 27% | 98 | 28 | 65T24144FCYBW | Fluted Cylinder Base Kit for 54/60"d x 144"w Top Surfaces | \$18,883 |
| 24% | 120% | 27% | 99 | 39 | 65T24150FCYBW | Fluted Cylinder Base Kit for 54/60"d x 150"w Top Surfaces | \$27,530 |
| 24% | 126% | 27% | 99 | 39 | 65T24156FCYBW | Fluted Cylinder Base Kit for 54/60"d x 156"w Top Surfaces | \$27,530 |
| 24% | 132% | 27% | 99 | 39 | 65T24162FCYBW | Fluted Cylinder Base Kit for 54/60"d x 162"w Top Surfaces | \$27,530 |
| 24% | 138% | 27% | 99 | 39 | 65T24168FCYBW | Fluted Cylinder Base Kit for 54/60"d x 168"w Top Surfaces | \$27,530 |
| 24% | 144% | 27% | 99 | 39 | 65T24174FCYBW | Fluted Cylinder Base Kit for 54/60"d x 174"w Top Surfaces | \$27,530 |
| 24% | 150% | 27% | 119 | 41 | 65T24180FCYBW | Fluted Cylinder Base Kit for 54/60"d x 180"w Top Surfaces | \$27,781 |
| 24% | 156% | 27% | 119 | 41 | 65T24186FCYBW | Fluted Cylinder Base Kit for 54/60"d x 186"w Top Surfaces | \$27,781 |
| 24% | 162% | 27% | 119 | 41 | 65T24192FCYBW | Fluted Cylinder Base Kit for 54/60"d x 192"w Top Surfaces | \$27,781 |
| 24% | 168% | 27% | 132 | 52 | 65T24198FCYBW | Fluted Cylinder Base Kit for 54/60"d x 198"w Top Surfaces | \$37,109 |
| 24% | 174% | 27% | 132 | 52 | 65T24204FCYBW | Fluted Cylinder Base Kit for 54/60"d x 204"w Top Surfaces | \$37,109 |
| 24% | 180% | 27% | 132 | 52 | 65T24210FCYBW | Fluted Cylinder Base Kit for 54/60"d x 210"w Top Surfaces | \$37,109 |
| 24% | 186% | 27% | 132 | 52 | 65T24216FCYBW | Fluted Cylinder Base Kit for 54/60"d x 216"w Top Surfaces | \$37,109 |
| 24% | 192% | 27% | 152 | 54 | 65T24222FCYBW | Fluted Cylinder Base Kit for 54/60"d x 222"w Top Surfaces | \$37,464 |
| 24% | 198% | 27% | 152 | 54 | 65T24228FCYBW | Fluted Cylinder Base Kit for 54/60"d x 228"w Top Surfaces | \$37,464 |
| 24% | 204% | 27% | 152 | 54 | 65T24234FCYBW | Fluted Cylinder Base Kit for 54/60"d x 234"w Top Surfaces | \$37,464 |
| 24% | 210% | 27% | 152 | 54 | 65T24240FCYBW | Fluted Cylinder Base Kit for 54/60"d x 240"w Top Surfaces | \$37,464 |

Model Base Wood

[see Anthology Solid Wood Finishes](#)

| Description | D | W | H | CTN WT | CU FT | ① Model | List Price |
|------------------------------|-----|-----|-----|-----------|----------|----------------|-------------|
| Flexible Wire Manager | 1 ¾ | 5 ¾ | 1 ¾ | | | 9P26FWM | \$32 |

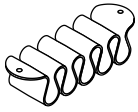

- black
- mounts to underside of top to support cords

| | | | | | | | |
|---|--|--|--|--|--|-----------------|--------------|
| Frame Base Magnetic Metal Wire Manager | | | | | | 65T22WMM | \$256 |
|---|--|--|--|--|--|-----------------|--------------|



- use with Frame and Frame BridgeLine bases only
- magnetic attachment to inside of base frame over cords to floor
- specify metal base colors
- chrome upcharge applies

| | | | | | | | |
|---|-----|-----|---|--|--|--------------|-------------|
| Wire Management Velcro Straps (set of 4) | 1 ¾ | 3 ½ | ¼ | | | 04WVS | \$63 |
|---|-----|-----|---|--|--|--------------|-------------|

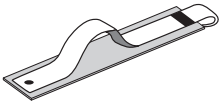

- set of four
- field installed with adhesive tape provided
- mounts under surface or on vertical panels
- black

| | | | | | | | |
|----------------------------------|---|---|--------|--|--|------------------|----------------|
| TFL Wire Management Chase | 7 | 7 | 27 7/8 | | | 65T728WCT | \$1,128 |
|----------------------------------|---|---|--------|--|--|------------------|----------------|

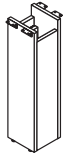

- mounts to underside of table top to conceal cords to floor outlet
- can be specified between bases where cord concealment to floor is required
- one side has lift off panel to access interior
- not for structural support

| Description | D | W | H | CTN WT | CU FT | ① Model | Essentials Veneer | Artisan Veneer |
|-------------------------------------|---|---|--------|-----------|----------|------------------|----------------------|-------------------|
| Veneer Wire Management Chase | 7 | 7 | 27 7/8 | | | 65T728WCV | \$1,159 | \$1,276 |

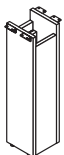

- mounts to underside of table top to conceal cords to floor outlet
- can be specified between bases where cord concealment to floor is required
- one side has lift off panel to access interior
- not for structural support

| Model | Laminate for Wire Chase | Veneer for Wire Chase | Metal Color |
|-------|---|---|--|
| | see Anthology Laminate Finishes | see Anthology Veneer Finishes | see Anthology Metal Colors |
| | | | Chrome Magnetic Wire Manager Upcharge - add \$320 |

| Description | D | W | H | CTN WT | CU FT | ① Model | List Price |
|--|---|---|-----|-----------|----------|---------------|--------------|
| Node Electrical Single Unit Power + Open - Corded | 4 | 4 | 3 ¼ | 3 | 1 | 9PCA1C | \$273 |

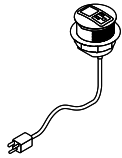

- flush mount design with one spill-proof black power outlet
- one open data port, 12 pack data adapter kit included. Accepts TCP300 series Telecom ports ordered separately
- 10' cord with 15 amp three-prong molded plug
- powdercoat aluminum
- UL listed

| | | | | | | | |
|---|---|---|-----|---|---|---------------|--------------|
| Node Electrical Single Unit Power - Corded | 4 | 4 | 3 ¼ | 3 | 1 | 9PCA2C | \$283 |
|---|---|---|-----|---|---|---------------|--------------|

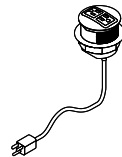

- flush mount design with two spill-proof, black power outlets
- 10' cord with 15 amp three-prong molded plug
- powdercoat aluminum
- UL listed

| | | | | | | | |
|---|---|---|-----|---|---|----------------|--------------|
| Node Electrical Single Unit Power + USB - Corded | 4 | 4 | 3 ¼ | 3 | 1 | 9PCA11C | \$418 |
|---|---|---|-----|---|---|----------------|--------------|

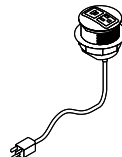

- flush mount design with one power and one 20 watt USB A+C (10 watt each)
- spill-proof design, black outlets
- 10' cord with 15 amp three-prong molded plug
- powdercoat aluminum
- UL listed

| | | | | | | | |
|--|-----|-----|-----|---|---|----------------|--------------|
| Electrolite Electrical Single Unit Power + USB - Corded | 2 ½ | 7 ¾ | 3 ¾ | 4 | 1 | 9PCB21C | \$710 |
|--|-----|-----|-----|---|---|----------------|--------------|

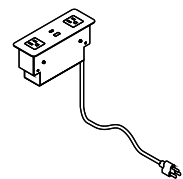

- In-Surface flush mount design with two power and one 72 watt USB A (12 watt) + C (60 watt)
- tamper resistant, black outlets
- 9' strain relief cord with 15 amp three-prong molded plug
- available in black body and face only
- ETL listed

Model Metal Finish

- B Black
- S Silver

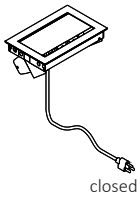

closed

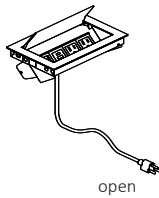

open

- In-Surface Aluminum frame with soft closing lid and cord routing slot
- 4 port unit with two power, one 20 watt USB A+C (10 watt each), and one open data port
- open port accepts TCP300 series Telecom ports ordered separately. 12 pack data adapter kit included
- 10' cord with 15 amp three-prong molded plug
- powdercoat aluminum frame and lid
- inside face plate and power/data outlets are black
- UL Listed

| D | W | H | CTN WT | CU FT | ① Model | Description | List Price |
|-------|-------|-------|-----------|----------|----------------|--|--------------|
| 5 3/8 | 8 3/8 | 3 1/2 | 3 | 1 | 9PCD21C | Ellora Electrical Single Unit, Single Sided Power + USB - Corded | \$699 |

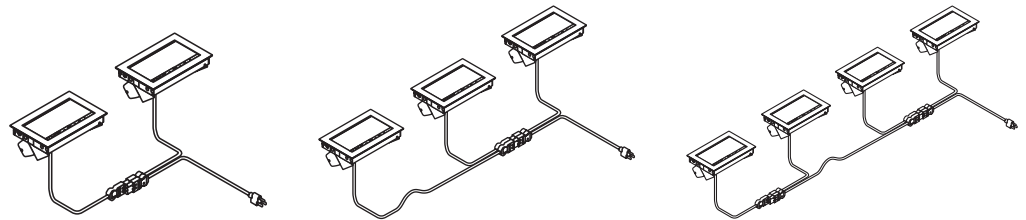

Pattern Modular Component System with Ellora One Sided Power Units

- available in 2-, 3-, and 4-unit kit models which include all components required: Ellora In-Surface Aluminum frame with soft closing lid and cord routing slot power units, single end power infeed, jumpers, distribution block, and mounting hardware
- Pattern Single Circuit Linking Power System is non-sequential and supports multiple Ellora units connected with one 10' cord and 15 amp molded plug
- each individual power unit features two power, one 20 watt USB A+C (10 watt each), and one open data port. Open port accepts TCP300 series Telecom ports ordered separately. 12 pack data adapter kit included
- powdercoat Aluminum; inside face plate and power/data outlets are black
- ETL Listed modular solution
- specify the model for number of kits, top width range and cutout locations to provide required jumper lengths and connection components

| D | W | H | CTN WT | CU FT | ① Model | Description | List Price |
|------------------------------|-------|-------|-----------|----------|---------------------|---|----------------|
| End Location | | | | | | | |
| 5 3/8 | 8 3/8 | 3 1/2 | 3 | 1 | 9PCD21K2EAC | Ellora Electrical 2 Unit Kit, Single Sided Power + USB- Corded, for 84- 114 Surfaces | \$2,114 |
| 5 3/8 | 8 3/8 | 3 1/2 | 3 | 1 | 9PCD21K2EBC | Ellora Electrical 2 Unit Kit, Single Sided Power + USB- Corded, for 120- 174 Surfaces | \$2,242 |
| 5 3/8 | 8 3/8 | 3 1/2 | 3 | 1 | 9PCD21K2ECC | Ellora Electrical 2 Unit Kit, Single Sided Power + USB- Corded, for 180- 192 Surfaces | \$2,183 |
| 5 3/8 | 8 3/8 | 3 1/2 | 3 | 1 | 9PCD21K2EDC | Ellora Electrical 2 Unit Kit, Single Sided Power + USB- Corded, for 198- 240 Surfaces | \$2,230 |
| Mid Location | | | | | | | |
| 5 3/8 | 8 3/8 | 3 1/2 | 3 | 1 | 9PCD21K2MBC | Ellora Electrical 2 Unit Kit, Single Sided Power + USB- Corded, for 120- 174 Surfaces | \$2,143 |
| 5 3/8 | 8 3/8 | 3 1/2 | 3 | 1 | 9PCD21K2MCC | Ellora Electrical 2 Unit Kit, Single Sided Power + USB- Corded, for 180- 192 Surfaces | \$2,271 |
| 5 3/8 | 8 3/8 | 3 1/2 | 3 | 1 | 9PCD21K2MDC | Ellora Electrical 2 Unit Kit, Single Sided Power + USB- Corded, for 198- 240 Surfaces | \$2,230 |
| Center + End Location | | | | | | | |
| 5 3/8 | 8 3/8 | 3 1/2 | 3 | 1 | 9PCD21K3CEBC | Ellora Electrical 3 Unit Kit, Single Sided Power + USB- Corded, for 120- 174 Surfaces | \$3,020 |
| 5 3/8 | 8 3/8 | 3 1/2 | 3 | 1 | 9PCD21K3CECC | Ellora Electrical 3 Unit Kit, Single Sided Power + USB- Corded, for 180- 192 Surfaces | \$3,020 |
| 5 3/8 | 8 3/8 | 3 1/2 | 3 | 1 | 9PCD21K3CEDC | Ellora Electrical 3 Unit Kit, Single Sided Power + USB- Corded, for 198- 240 Surfaces | \$3,173 |
| Center + Mid Location | | | | | | | |
| 5 3/8 | 8 3/8 | 3 1/2 | 3 | 1 | 9PCD21K3CMDC | Ellora Electrical 3 Unit Kit, Single Sided Power + USB- Corded, for 198- 240 Surfaces | \$3,035 |
| Mid + End Location | | | | | | | |
| 5 3/8 | 8 3/8 | 3 1/2 | 3 | 1 | 9PCD21K4MEDC | Ellora Electrical 4 Unit Kit, Single Sided Power + USB- Corded, for 198- 240 Surfaces | \$3,919 |

| Model | Metal Finish |
|-------|--------------|
| B | Black |
| S | Silver |

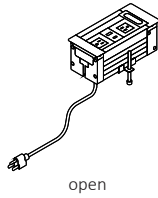
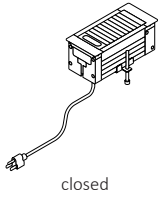

- In-surface with sliding, retractable door to access outlets
- two power, one USB A (10 watt) + C (15 watt)
- 10' cord with 15 amp three-prong molded plug
- black trim with gray retractable door and black outlet face
- ETL Listed

| D | W | H | CTN WT | CU FT | ① Model | Description | List Price |
|----|----|---|-----------|----------|----------------|--|--------------|
| 3½ | 8½ | 5 | 3 | 1 | 9PCE21C | Vault Z23 Electrical Single Unit, Retractable Door Power + USB- Corded | \$698 |

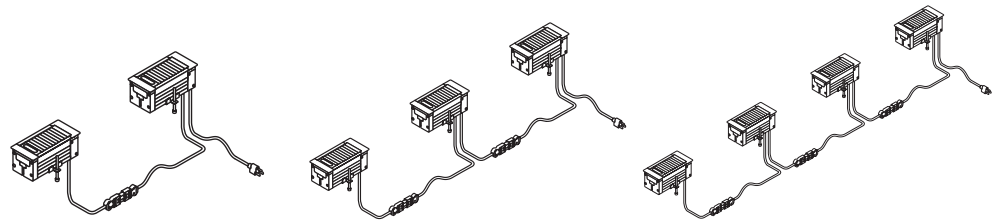

Modular Connection System with Vault Z23 Retractable Power Units

- available in 2-, 3-, and 4-unit kit models which include all connection required: Z23 In-Surface with sliding retractable door, single end power infeed, jumpers and mounting hardware
- Sequential single circuit connection kit supports multiple Z23 units connected with one 9' cord and 15 amp molded plug
- Each individual power unit features two power, one USB A (10 watt) + C (15 watt)
- Black trim with dark gray retractable door and black outlet face
- ETL Listed modular solution
- specify the model for number of kits, top width range and cutout locations to provide required jumper lengths and connection components

| D | W | H | CTN WT | CU FT | ① Model | Description | List Price |
|------------------------------|----|---|-----------|----------|---------------------|---|----------------|
| End Location | | | | | | | |
| 3½ | 8½ | 5 | 3 | 1 | 9PCE21K2EAC | Vault Z23 Electrical 2 Unit Kit, Retractable Door Power + USB- Corded for 84- 114 Surfaces | \$1,273 |
| Mid Location | | | | | | | |
| 3½ | 8½ | 5 | 3 | 1 | 9PCE21K2MBC | Vault Z23 Electrical 2 Unit Kit, Retractable Door Power + USB- Corded for 120- 174 Surfaces | \$1,273 |
| Center + End Location | | | | | | | |
| 3½ | 8½ | 5 | 3 | 1 | 9PCE21K3CEAC | Vault Z23 Electrical 3 Unit Kit, Retractable Door Power + USB- Corded for 102- 114 Surfaces | \$1,815 |
| 3½ | 8½ | 5 | 3 | 1 | 9PCE21K3CEBC | Vault Z23 Electrical 3 Unit Kit, Retractable Door Power + USB- Corded for 120- 174 Surfaces | \$1,815 |
| Center + Mid Location | | | | | | | |
| 3½ | 8½ | 5 | 3 | 1 | 9PCE21K3CMDC | Vault Z23 Electrical 3 Unit Kit, Retractable Door Power + USB- Corded for 198- 234 Surfaces | \$1,815 |
| Mid + End Location | | | | | | | |
| 3½ | 8½ | 5 | 3 | 1 | 9PCE21K4MEDC | Vault Z23 Electrical 4 Unit Kit, Retractable Door Power + USB- Corded for 198- 234 Surfaces | \$2,359 |

Model

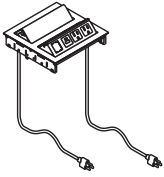

- two-Sided, In-Surface Aluminum frame with retractable one touch doors
- each side has 4 ports with two power, one 20 watt USB A+C (10 watt each), and one open data port
- unit total is four power, two 20 watt USB A+C (10 watt each) and two open data ports
- 12 pack data adapter kit included. Open ports accept TCP300 series Telecom ports ordered separately
- two 10' cord with 15 amp three-prong molded plug, one per side
- powdercoat Aluminum frame
- inside face plate and power/data outlets are black
- UL Listed

| D | W | H | CTN WT | CU FT | ① Model | Description | List Price |
|-------|-------|-------|-----------|----------|----------------|---|----------------|
| 8 1/8 | 8 1/4 | 1 1/2 | 6 | 1 | 9PCF42C | M2X Electrical Single Unit, Two Sided Power + USB- Corded | \$1,225 |

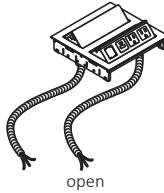
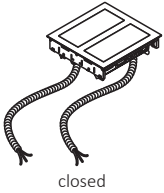

- two-Sided, In-Surface Aluminum frame with retractable one touch doors
- each side has 4 ports with two power, one 20 watt USB A+C (10 watt each), and one open data port
- unit total is four power, two 20 watt USB A+C (10 watt each) and two open data ports
- 12 pack data adapter kit included. Open ports accept TCP300 series Telecom ports ordered separately
- two 10' Chicago hardwire, one per side
- powdercoat Aluminum frame
- inside face plate and power/data outlets are black
- UL Listed

| D | W | H | CTN WT | CU FT | ① Model | Description | List Price |
|-------|-------|-------|-----------|----------|----------------|---|----------------|
| 8 1/8 | 8 1/4 | 1 1/2 | 9 | 1 | 9PCF42H | M2X Electrical Single Unit, Two Sided Power + USB- Hardwire | \$1,402 |

Model | **Metal Finish**

- B** Black
- S** Silver

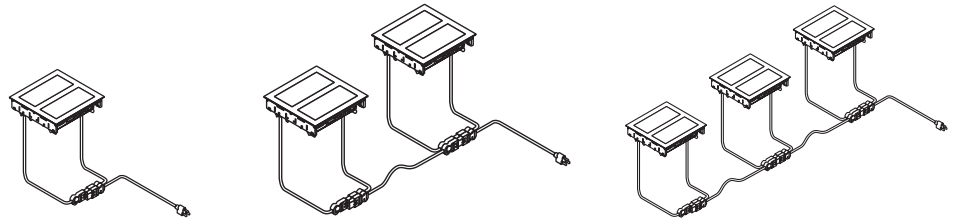

Pattern Modular Component System with M2X Two Sided Power Units

- available in 1-, 2-, and 3-unit kit models which include all components required: M2X In-Surface aluminum frame with retractable one touch doors, single end power infeed, jumpers, distribution block, and mounting hardware
- Pattern Single Circuit Linking Power System is non-sequential and supports multiple M2X units connected with one 10' cord and 15 amp molded plug
- each individual power unit features four power, two 20 watt USB A+C (10 watt each) and two open data port
- 12 pack data adapter kit included. Open port accepts TCP300 series Telecom ports ordered separately
- powdercoat aluminum. Inside face plate and power/data outlets are black
- ETL Listed modular solution
- specify the model for number of kits, top width range and cutout locations to provide required jumper lengths and connection components

| D | W | H | CTN WT | CU FT | ① Model | Description | List Price |
|------------------------------|-------|-------|-----------|----------|---------------------|---|----------------|
| Center Location | | | | | | | |
| 8 1/8 | 8 1/4 | 1 1/2 | 6 | 1 | 9PCF42K1C | M2X Electrical 1 Unit Kit, Two Sided Power + USB- Coded | \$1,910 |
| End Location | | | | | | | |
| 8 1/8 | 8 1/4 | 1 1/2 | 6 | 1 | 9PCF42K2EBC | M2X Electrical 2 Unit Kit, Two Sided Power + USB- Coded for 120- 174 Surfaces | \$3,446 |
| 8 1/8 | 8 1/4 | 1 1/2 | 6 | 1 | 9PCF42K2ECC | M2X Electrical 2 Unit Kit, Two Sided Power + USB- Coded for 180- 192 Surfaces | \$3,476 |
| 8 1/8 | 8 1/4 | 1 1/2 | 6 | 1 | 9PCF42K2EDC | M2X Electrical 2 Unit Kit, Two Sided Power + USB- Coded for 198- 240 Surfaces | \$3,566 |
| Mid Location | | | | | | | |
| 8 1/8 | 8 1/4 | 1 1/2 | 6 | 1 | 9PCF42K2MBC | M2X Electrical 2 Unit Kit, Two Sided Power + USB- Coded for 120- 174 Surfaces | \$3,348 |
| 8 1/8 | 8 1/4 | 1 1/2 | 6 | 1 | 9PCF42K2MCC | M2X Electrical 2 Unit Kit, Two Sided Power + USB- Coded for 180- 192 Surfaces | \$3,388 |
| 8 1/8 | 8 1/4 | 1 1/2 | 6 | 1 | 9PCF42K2MDC | M2X Electrical 2 Unit Kit, Two Sided Power + USB- Coded for 198- 240 Surfaces | \$3,460 |
| Center + End Location | | | | | | | |
| 8 1/8 | 8 1/4 | 1 1/2 | 6 | 1 | 9PCF42K3CEBC | M2X Electrical 3 Unit Kit, Two Sided Power + USB- Coded for 120- 174 Surfaces | \$4,727 |
| 8 1/8 | 8 1/4 | 1 1/2 | 6 | 1 | 9PCF42K3CECC | M2X Electrical 3 Unit Kit, Two Sided Power + USB- Coded for 180- 192 Surfaces | \$4,862 |
| 8 1/8 | 8 1/4 | 1 1/2 | 6 | 1 | 9PCF42K3CEDC | M2X Electrical 3 Unit Kit, Two Sided Power + USB- Coded for 198- 240 Surfaces | \$4,872 |
| Center + Mid Location | | | | | | | |
| 8 1/8 | 8 1/4 | 1 1/2 | 6 | 1 | 9PCF42K3CMDC | M2X Electrical 3 Unit Kit, Two Sided Power + USB- Coded for 198- 240 Surfaces | \$4,821 |

Model | Metal Finish

- B** Black
- S** Silver

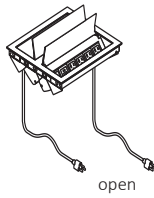
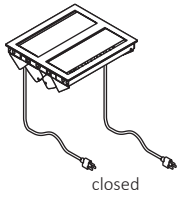

- two-Sided, In-Surface Aluminum frame with soft closing lid and cord routing slot
- each side has 6 ports with four power, one 20 watt USB A+C (10 watt each) and one open data port
- unit total is eight power, two 20 watt USB A+C (10 watt each), and two open data ports
- 12 pack data adapter kit included. Open ports accept TCP300 series Telecom ports ordered separately
- two 10' cord with 15 amp three-prong molded plug, one per side
- powdercoat Aluminum frame and lid
- inside face plate and power/data outlets are black
- UL Listed

| D | W | H | CTN WT | CU FT | ① Model | Description | List Price |
|------|------|-----|-----------|----------|----------------|---|----------------|
| 10 ¼ | 11 ¾ | 3 ½ | 9 | 1 | 9PCG82C | Ellora Double Electrical Single Unit, Two Sided Power + USB- Corded | \$1,701 |

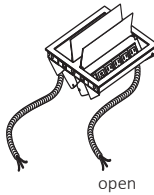
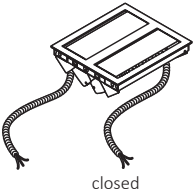

- two-Sided, In-Surface Aluminum frame with soft closing lid and cord routing slot
- each side has 6 ports with four power, one 20 watt USB A+C (10 watt each) and one open data port
- unit total is eight power, two 20 watt USB A+C (10 watt each) and two open data ports
- 12 pack data adapter kit included. Open ports accept TCP300 series Telecom ports ordered separately
- two 10' Chicago hardwire, one per side
- powdercoat Aluminum frame and lid
- inside face plate and power/data outlets are black
- UL Listed

| D | W | H | CTN WT | CU FT | ① Model | Description | List Price |
|------|------|-----|-----------|----------|----------------|---|----------------|
| 10 ¼ | 11 ¾ | 3 ½ | 12 | 1 | 9PCG82H | Ellora Double Electrical Single Unit, Two Sided Power + USB- Hardwire | \$1,714 |

Model | **Metal Finish**

- B** Black
- S** Silver

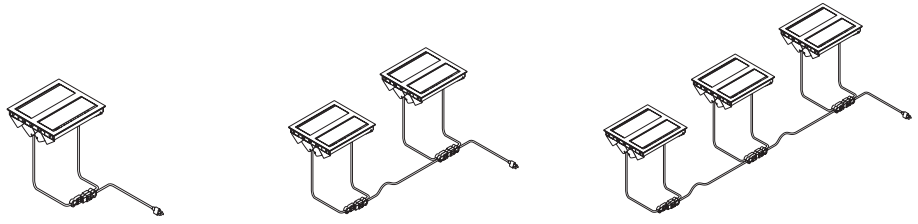

Pattern Modular Component System with Ellora Double Power Units

- available in 1-, 2- , and 3-unit kit models which include all components required: Ellora Double In-Surface Aluminum frame with soft closing lid and cord routing slot power units, single end power infeed, jumpers, distribution block, and mounting hardware
- Pattern Single Circuit Linking Power System is non-sequential and supports multiple Ellora Double units connected with one 10’ cord and 15 amp molded plug
- each individual power unit features eight power, two 20 watt USB A+C (10 watt each) and two open data port. 12 pack data adapter kit included. Open port accepts TCP300 series Telecom ports ordered separately
- powdercoat aluminum. Inside face plate and power/data outlets are black
- ETL Listed modular solution
- specify the model for number of kits, top width range and cutout locations to provide required jumper lengths and connection components lengths and connection components

| D | W | H | CTN WT | CU FT | ① Model | Description | List Price |
|-------------------------------|------|-----|-----------|----------|---------------------|---|----------------|
| Center Location | | | | | | | |
| 10 ¼ | 11 ¾ | 3 ½ | 9 | 1 | 9PCG82K1C | Ellora Double Electrical 1 Unit Kit, Two Sided Power + USB- Corded | \$2,465 |
| End Location | | | | | | | |
| 10 ¼ | 11 ¾ | 3 ½ | 9 | 1 | 9PCG82K2EBC | Ellora Double Electrical 2 Unit Kit, Two Sided Power + USB- Corded for 120- 174 Surfaces | \$4,127 |
| 10 ¼ | 11 ¾ | 3 ½ | 9 | 1 | 9PCG82K2ECC | Ellora Double Electrical 2 Unit Kit, Two Sided Power + USB- Corded for 180- 192 Surfaces | \$4,230 |
| 10 ¼ | 11 ¾ | 3 ½ | 9 | 1 | 9PCG82K2EDC | Ellora Double Electrical 2 Unit Kit, Two Sided Power + USB- Corded for 198- 240 Surfaces | \$4,333 |
| Mid Location | | | | | | | |
| 10 ¼ | 11 ¾ | 3 ½ | 9 | 1 | 9PCG82K2MBC | Ellora Double Electrical 2 Unit Kit, Two Sided Power + USB- Corded, for 120- 174 Surfaces | \$4,127 |
| 10 ¼ | 11 ¾ | 3 ½ | 9 | 1 | 9PCG82K2MCC | Ellora Double Electrical 2 Unit Kit, Two Sided Power + USB- Corded, for 180- 192 Surfaces | \$4,230 |
| 10 ¼ | 11 ¾ | 3 ½ | 9 | 1 | 9PCG82K2MDC | Ellora Double Electrical 2 Unit Kit, Two Sided Power + USB- Corded, for 198- 240 Surfaces | \$4,333 |
| Center + Ends Location | | | | | | | |
| 10 ¼ | 11 ¾ | 3 ½ | 9 | 1 | 9PCG82K3CEBC | Ellora Double Electrical 3 Unit Kit, Two Sided Power + USB- Corded, for 120- 174 Surfaces | \$6,498 |
| 10 ¼ | 11 ¾ | 3 ½ | 9 | 1 | 9PCG82K3CECC | Ellora Double Electrical 3 Unit Kit, Two Sided Power + USB- Corded, for 180- 192 Surfaces | \$6,527 |
| 10 ¼ | 11 ¾ | 3 ½ | 9 | 1 | 9PCG82K3CEDC | Ellora Double Electrical 3 Unit Kit, Two Sided Power + USB- Corded, for 198- 240 Surfaces | \$6,625 |
| Center + Mid Location | | | | | | | |
| 10 ¼ | 11 ¾ | 3 ½ | 9 | 1 | 9PCG82K3CMDC | Ellora Double Electrical 3 Unit Kit, Two Sided Power + USB- Corded, for 198- 240 Surfaces | \$6,491 |

Model Metal Finish

- B** Black
- S** Silver

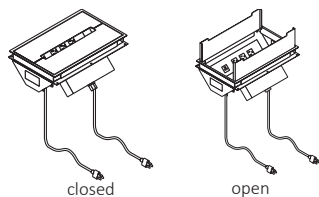

- In-Surface with metal hinged lids that flip up from center and cord routing slots when closed
- six power (three per face), two 72 watt USB A(12 watt) + C(60 watt). Two faceplate openings (one each end). Open ports accept TCP100 Telecom ports ordered separately. Data adapter kit included
- tamper resistant
- two 9' cords with 15 amp three-prong molded plug
- available in seven standard exterior trim finishes with interior and outlet faces in black
- UL Listed

| D | W | H | CTN WT | CU FT | ① Model | Description | List Price |
|---|--------|-------|-----------|----------|----------------|---|----------------|
| 9 | 14 3/8 | 5 1/8 | 9 | 1 | 9PCH62C | Oasis Electrical Single Unit, Two Sided Power + USB- Corded | \$1,764 |

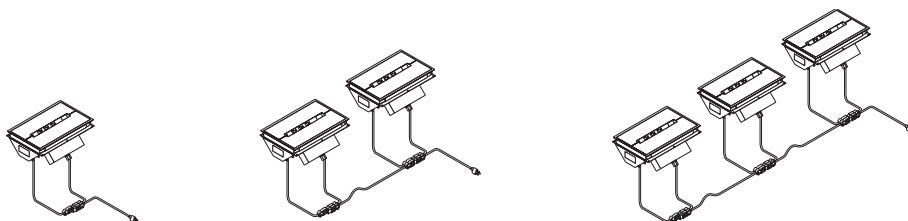

PURL Modular Component System with Oasis Power Units

- available in 1-, 2-, and 3-unit kit models which include all components required: Oasis In-Surface power units, single end power infeed, jumpers, splitters and mounting hardware
- PURL Single Circuit Linking Power System is non-sequential and supports multiple Oasis power units connected with one 9' cord and 15 amp molded plug
- each individual power unit features six power (three per face), two 72 watt USB A(12 watt) + C(60 watt). Two faceplate openings (one each end). Open ports accept TCP100 series Telecom ports ordered separately.
- available in seven standard exterior trim finishes with interior and outlet faces in black
- UL Listed modular solution
- specify the model for number of kits, top width range and cutout locations to provide required jumper lengths and connection components lengths and connection components

| D | W | H | CTN WT | CU FT | ① Model | Description | List Price |
|------------------------------|--------|-------|-----------|----------|---------------------|---|----------------|
| Center Location | | | | | | | |
| 9 | 14 3/8 | 5 1/8 | 9 | 1 | 9PCH62K1C | Oasis Electrical 1 Unit Kit, Two Sided Power + USB- Corded | \$1,932 |
| Mid Location | | | | | | | |
| 9 | 14 3/8 | 5 1/8 | 9 | 1 | 9PCH62K2MBC | Oasis Electrical 2 Unit Kit, Two Sided Power + USB- Corded, for 120- 174 Surfaces | \$3,495 |
| 9 | 14 3/8 | 5 1/8 | 9 | 1 | 9PCH62K2MCC | Oasis Electrical 2 Unit Kit, Two Sided Power + USB- Corded, for 180- 192 Surfaces | \$3,478 |
| 9 | 14 3/8 | 5 1/8 | 9 | 1 | 9PCH62K2MDC | Oasis Electrical 2 Unit Kit, Two Sided Power + USB- Corded, for 198- 240 Surfaces | \$3,497 |
| Center + Mid Location | | | | | | | |
| 9 | 14 3/8 | 5 1/8 | 9 | 1 | 9PCH62K3CMDC | Oasis Electrical 3 Unit Kit, Two Sided Power + USB- Corded, for 198- 240 Surfaces | \$4,803 |

Model | Metal Finish

| | |
|------------|---------------|
| ABZ | Aged Bronze |
| ASL | Arctic Silver |
| GLD | Gold |
| MBK | Matte Black |
| PEW | Pewter |
| SBZ | Soft Bronze |
| SNK | Soft Nickel |

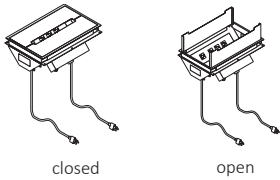

- In-Surface with metal hinged lids that flip up from center and cord routing slot when closed
- eight power (four per face), two faceplate openings (one each end). Open ports accept TCP100 series Telecom ports ordered separately. Data adapter kit included
- tamper resistant
- one 9' cord with 15 amp three-prong molded plug
- available in seven standard exterior trim finishes with interior and outlet faces in black
- UL Listed

| D | W | H | CTN WT | CU FT | ① Model | Description | List Price |
|---|--------|-------|-----------|----------|---------------|---|----------------|
| 9 | 14 3/8 | 5 1/8 | 9 | 1 | 9PCH8C | Oasis Electrical Single Unit, Two Sided Power - Corded | \$1,540 |

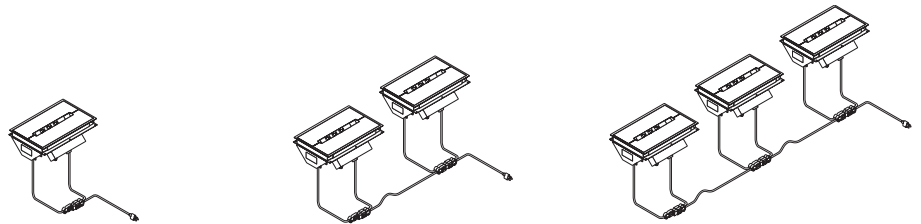

PURL Modular Component System with Oasis Power Units

- available in 1-, 2-, and 3-unit kit models which include all components required: Oasis In-Surface power units, single end power infeed, jumpers, splitters and mounting hardware.
- PURL Single Circuit Linking Power System is non-sequential and supports multiple Oasis power units connected with one 9' cord and 15 amp molded plug
- each individual power unit features eight power (four per face), two faceplate openings (one each end). Open ports accept TCP100 series Telecom ports ordered separately.
- available in seven standard exterior trim finishes with interior and outlet faces in black
- UL Listed modular solution
- specify the model for number of kits, top width range and cutout locations to provide required jumper lengths and connection components lengths and connection components

| D | W | H | CTN WT | CU FT | ① Model | Description | List Price |
|------------------------------|--------|-------|-----------|----------|--------------------|---|----------------|
| Center Location | | | | | | | |
| 9 | 14 3/8 | 5 1/8 | 9 | 1 | 9PCH8K1C | Oasis Electrical 1 Unit Kit, Two Sided Power- Corded | \$1,707 |
| Mid Location | | | | | | | |
| 9 | 14 3/8 | 5 1/8 | 9 | 1 | 9PCH8K2MBC | Oasis Electrical 2 Unit Kit, Two Sided Power- Corded, for 120- 174 Surfaces | \$2,972 |
| 9 | 14 3/8 | 5 1/8 | 9 | 1 | 9PCH8K2MCC | Oasis Electrical 2 Unit Kit, Two Sided Power- Corded, for 180- 192 Surfaces | \$3,122 |
| 9 | 14 3/8 | 5 1/8 | 9 | 1 | 9PCH8K2MDC | Oasis Electrical 2 Unit Kit, Two Sided Power- Corded, for 198-240 Surfaces | \$3,052 |
| Center + Mid Location | | | | | | | |
| 9 | 14 3/8 | 5 1/8 | 9 | 1 | 9PCH8K3CMDC | Oasis Electrical 3 Unit Kit, Two Sided Power- Corded, for 198- 240 Surfaces | \$4,131 |

Model | Metal Finish

- ABZ** Aged Bronze
- ASL** Arctic Silver
- GLD** Gold
- MBK** Matte Black
- PEW** Pewter
- SBZ** Soft Bronze
- SNK** Soft Nickel

| Description | D | W | H | CTN WT | CU FT | Model | List Price |
|---|-------|----|---|-----------|----------|-----------------|----------------|
| Vault BTC Electrical Single Unit, Rotating Power + USB + HDMI - Corded | 4 1/4 | 16 | 5 | 7 | 1 | 9PCJ321C | \$1,729 |

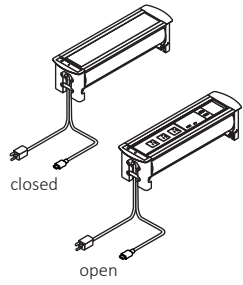

- In-Surface, one touch open to close mechanism, 180 degree motorized pivot rotation
- safety stop rotation sensors prevent closure when outlets in use or obstruction detected
- three power, one USB A (15 watt) + C (45 watt), one HDMI, plus one 15-watt USB-A
- 12' cord with 15 amp three-prong molded plug
- anodized aluminum with black outlet face
- UL Listed

Model

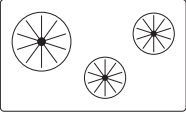
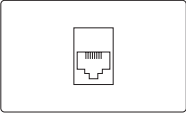
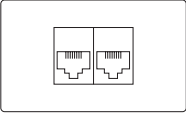
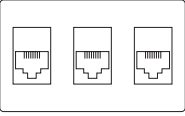
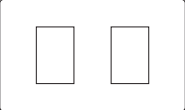
| Description | D | W | H | CTN WT | CU FT | Model | List Price |
|---|---|-------|-------|-----------|----------|---------------|--------------|
| Blank Cap Data Plate, Type 1  <ul style="list-style-type: none"> • blank data plate • black • for use with Oasis power units | | 1 3/4 | 3 1/8 | | | TCP101 | \$19 |
| Three Cord Bushing Data Plate, Type 1  <ul style="list-style-type: none"> • cord minder- three cord bushing • black • for use with Oasis power units | | 1 3/4 | 3 1/8 | | | TCP102 | \$86 |
| One Jack Data Plate, Type 1  <ul style="list-style-type: none"> • one RJ-45 CAT6 Jack • black • for use with Oasis power units | | 1 3/4 | 3 1/8 | | | TCP104 | \$108 |
| Two Jack Data Plate, Type 1  <ul style="list-style-type: none"> • two RJ-45 CAT6 Jacks • black • for use with Oasis power units | | 1 3/4 | 3 1/8 | | | TCP105 | \$181 |
| Three Jack Data Plate, Type 1  <ul style="list-style-type: none"> • three RJ-45 CAT6 Jacks • black • for use with Oasis power units | | 1 3/4 | 3 1/8 | | | TCP106 | \$254 |
| Two Open Data Ports, Type 1  <ul style="list-style-type: none"> • use with two Type 3 Telecom Jacks • black • for use with Oasis power units | | 1 3/4 | 3 1/8 | | | TCP110 | \$19 |

Model

| Description | D | W | H | CTN WT | CU FT | Model | List Price |
|--------------------------------|---|-------|-------|-----------|----------|---------------|--------------|
| HDMI Data Plate, Type 1 | | 1 3/4 | 3 1/8 | | | TCP107 | \$239 |

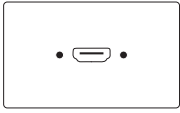

- one HDMI female to female connection with 36" cord
- black
- for use with Oasis power units

| | | | | | | | |
|---|--|-------|-------|--|--|---------------|--------------|
| HDMI and Data Jack Plate, Type 1 | | 1 3/4 | 3 1/8 | | | TCP113 | \$281 |
|---|--|-------|-------|--|--|---------------|--------------|

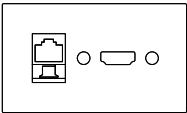

- one HDMI female to female connection with 36" cord one RJ45 CAT6 punch down jack
- black
- for use with Oasis power units

| | | | | | | | |
|---|--|--|--|--|--|---------------|--------------|
| HDMI Connector Accessory, Type 3 | | | | | | TCP301 | \$123 |
|---|--|--|--|--|--|---------------|--------------|

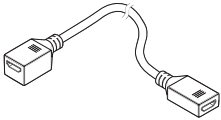

- one HDMI coupler female to female connection with 18" cord
- use 12 pack data adapter kit CCC adapter trim shaped with unit
- black
- for use with Node, Ellora, M2X, Ellora Double and Glenbeigh power units

| | | | | | | | |
|---------------------------------------|--|--|--|--|--|---------------|--------------|
| Network Jack Accessory, Type 3 | | | | | | TCP303 | \$114 |
|---------------------------------------|--|--|--|--|--|---------------|--------------|

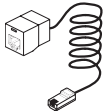

- one RJ45 CAT6 coupler female to female connection with 10' cord
- use 12 pack data adapter kit FFF adapter trim shipped with unit
- black
- for use with Node, Ellora, M2X, Ellora Double and Glenbeigh power units

Model

Data Adapter Applications

12 Pack Data Adapter Kit ships with Power Units: Node, Ellora, Ellora Double and M2X with open ports.

Black plastic adapter trims are marked on the back surface with letter designators that indicate the data jack manufacturer, series and style. Manufactures websites are listed below for quick reference to verify data jack series and style.

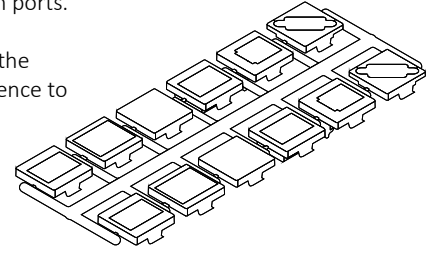

| Adapter | Manufacturer | Website |
|---------|--|--|
| BBB* | L-Com Keystone Modular | www.L-Com.com |
| BBB* | NETCONNECT, and 110 Connect Series Modular Jack | www.Anixter.com |
| BBB | Siemon ZMAX Style | www.Siemon.com |
| BBB* | Allen Tel Versa Tap Series | www.Graybar.com |
| BBB* | Leviton Quick Port® Series | www.Leviton.com |
| BBB* | Belden REVConnect | www.Belden.com |
| CCC | HDMI Adapter Cable | www.Byrne.com |
| CCC | Hubbell Nextspeed™ Keystone Series | www.Hubbell-premise.com |
| CCC | ADC Truenet series | www.Anixter.com |
| DDD | Blank (no coupler/jack) | |
| EEE | Ortronics TracJack Series | www.Ortronics.com |
| FFF | Panduit Mini-Com Series | www.Panduit.com |
| HHH | Video Monitor Jack/DB-15, panel mount solder style | www.Bryne.com |

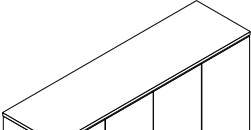
| Description | D | W | H | CTN WT | CU FT | ① Model | Laminate T | ESS Veneer V | ART Veneer V |
|--|----|----|----------|-----------|----------|---------------------|----------------|--------------------|--------------------|
|  | 20 | 36 | 35 15/16 | 139 | 21 | 65C203636CB_ | \$2,054 | \$2,737 | \$3,010 |
| | 20 | 60 | 35 15/16 | 224 | 33 | 65C206036CB_ | \$2,599 | \$3,520 | \$3,871 |
| | 20 | 72 | 35 15/16 | 266 | 39 | 65C207236CB_ | \$2,827 | \$3,694 | \$4,064 |
| | 20 | 90 | 35 15/16 | 342 | 49 | 65C209036CB_ | \$3,269 | \$4,275 | \$4,702 |

- 110° hinge doors
- touch latch doors
- one adjustable shelf per compartment
- unfinished back, includes cutout in back side for wire management pass through
- utility drawer 65C1727UD_ available on right and left sections of the credenza specify and order separately
- utility drawer will not fit in the middle section of the 90" units

Laminate

| Model | Top Surface TFL Laminate | Chassis Laminate | Door Laminate | Locking | Grommet | Electrical Cutout |
|-------|---|---|---|---|--|--|
| | see Anthology Top Surface TFL Laminate Finishes | see Anthology Chassis Laminate Finishes | see Anthology Laminate Finishes | NLK No Locking YLK Locking - add \$53 per door set ASL Arctic Silver MBK Matte Black | NGR No Grommet YGR Two Grommets - add \$116 ASL Arctic Silver MBK Matte Black | NECU No Electrical Cutout YECU Electrical Cutout - add \$34 |

Veneer

| Model | Top Surface/Chassis/Door Front | Locking | Grommet | Electrical Cutout |
|-------|---|---|--|--|
| | see Anthology Top Surface/Chassis/Door Front Finishes see Contrasting Painted Door Front Colors Painted Door Front Upcharge - add \$365 | NLK No Locking YLK Locking - add \$53 per door set ASL Arctic Silver MBK Matte Black | NGR No Grommet YGR Two Grommets - add \$116 ASL Arctic Silver MBK Matte Black | NECU No Electrical Cutout YECU Electrical Cutout - add \$34 |

| Description | D | W | H | CTN WT | CU FT | ① Model | Laminate T | ESS Veneer V | ART Veneer V |
|--------------------|----|----|----------|-----------|----------|---------------|---------------|--------------------|--------------------|
| Equipment Credenza | 24 | 48 | 35 15/16 | 223 | 32 | 65C244836CER_ | \$2,408 | \$3,119 | \$3,430 |
| | 24 | 48 | 35 15/16 | 295 | 32 | 65C244836CEL_ | \$2,408 | \$3,119 | \$3,430 |
| | 24 | 72 | 35 15/16 | 223 | 46 | 65C247236CER_ | \$3,286 | \$4,324 | \$4,757 |
| | 24 | 72 | 35 15/16 | 295 | 46 | 65C247236CEL_ | \$3,286 | \$4,324 | \$4,757 |

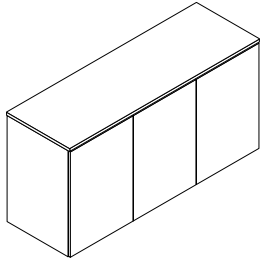

- 110° hinge doors
- touch latch doors
- one adjustable shelf per compartment
- unfinished back, includes cutout in back side for wire management pass through
- thermostat control fan 65C1019TCF available specify and order separately
- pull out rotating AV rack 65C19PAV available specify and order separately
- pull out dual waste, recycle unit 65C2214PDW available order separately

Laminate

| Model | Top Surface TFL Laminate | Chassis Laminate | Door Laminate | Locking | Grommet | Electrical Cutout | Accessories |
|-------|---|---|--|---|---|---|--|
| | see Anthology Top Surface TFL Laminate Finishes | see Anthology Chassis Laminate Finishes | see Anthology Door Laminate Finishes | NLK No Locking YLK Locking - add \$53 ASL Arctic Silver MBK Matte Black | NGR No Grommet YGR Two Grommets - add \$116 ASL Arctic Silver MBK Matte Black | NECU No Electrical Cutout YECU Electrical Cutout - add \$34 | Control Fan AV Rack Pull Out Dual Waste, Recycle Unit order separately |

Veneer

| Model | Top Surface/Chassis/Door Front | Locking | Grommet | Electrical Cutout | Accessories |
|-------|--|---|---|---|---|
| | see Anthology Top Surface/Chassis/Door Front Finishes see Contrasting Painted Door Front Colors Painted Door Front Upcharge - add \$365 | NLK No Locking YLK Locking - add \$53 ASL Arctic Silver MBK Matte Black | NGR No Grommet YGR Two Grommets - add \$116 ASL Arctic Silver MBK Matte Black | NECU No Electrical Cutout YECU Electrical Cutout - add \$34 | Control Fan AV Rack Pull Out Dual Waste, Recycle Unit order separately |

| Description | D | W | H | CTN WT | CU FT | ① Model | Laminate T | ESS Veneer V | ART Veneer V |
|----------------------------|----|----|----------------------------------|--------|-------|---------------------|------------|--------------|--------------|
| Conference Credenza | 20 | 36 | 28 ¹⁵ / ₁₆ | 123 | 17 | 65C203629CC_ | \$1,976 | \$2,646 | \$2,909 |
| | 20 | 60 | 28 ¹⁵ / ₁₆ | 205 | 27 | 65C206029CC_ | \$2,547 | \$3,429 | \$3,771 |
| | 20 | 72 | 28 ¹⁵ / ₁₆ | 237 | 32 | 65C207229CC_ | \$2,580 | \$3,447 | \$3,792 |
| | 20 | 90 | 28 ¹⁵ / ₁₆ | 308 | 40 | 65C209029CC_ | \$2,922 | \$3,658 | \$4,025 |

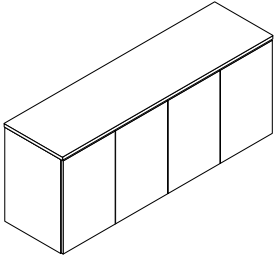

- 110° hinge doors
- touch latch doors
- one adjustable shelf per compartment
- unfinished back, includes cutout in back side for wire management pass through

| | | | | | | | | | |
|----------------------------|----|----|----------------------------------|-----|----|---------------------|---------|---------|---------|
| Low Height Credenza | 20 | 36 | 23 ¹⁵ / ₁₆ | 110 | 14 | 65C203624CL_ | \$1,857 | \$2,590 | \$2,848 |
| | 20 | 60 | 23 ¹⁵ / ₁₆ | 184 | 23 | 65C206024CL_ | \$2,442 | \$3,300 | \$3,629 |
| | 20 | 72 | 23 ¹⁵ / ₁₆ | 212 | 27 | 65C207224CL_ | \$2,487 | \$3,210 | \$3,531 |
| | 20 | 90 | 23 ¹⁵ / ₁₆ | 281 | 34 | 65C209024CL_ | \$2,832 | \$3,506 | \$3,857 |

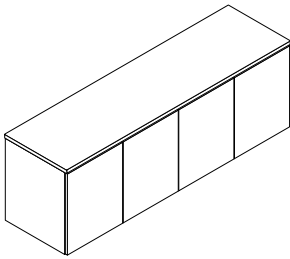

- 110° hinge doors
- touch latch doors
- one adjustable shelf per compartment
- unfinished back, includes cutout in back side for wire management pass through

| | | | | | | | | | |
|----------------------------|----|----|----|-----|----|---------------------|---------|---------|---------|
| Wall Mount Credenza | 20 | 36 | 17 | 73 | 11 | 65C203617CW_ | \$1,699 | \$2,342 | \$2,577 |
| | 20 | 60 | 17 | 123 | 17 | 65C206017CW_ | \$2,142 | \$2,874 | \$3,162 |
| | 20 | 72 | 17 | 145 | 20 | 65C207217CW_ | \$2,282 | \$3,098 | \$3,408 |
| | 20 | 90 | 17 | 186 | 25 | 65C209017CW_ | \$2,422 | \$3,484 | \$3,832 |

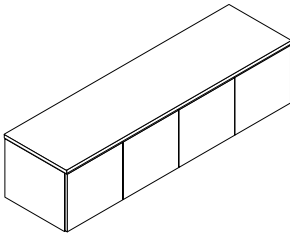

- 110° hinge doors
- touch latch doors
- unfinished back
- unfinished back, includes cutout in back side for wire management pass through

Laminate

| Model | Top Surface TFL Laminate | Chassis Laminate | Door Laminate | Locking | Grommet | Electrical Cutout |
|-------|---|---|---|---|--|--|
| | see Anthology Top Surface TFL Laminate Finishes | see Anthology Chassis Laminate Finishes | see Anthology Laminate Finishes | NLK No Locking YLK Locking - add \$53 per door set ASL Arctic Silver MBK Matte Black | NGR No Grommet YGR Two Grommets - add \$116 ASL Arctic Silver MBK Matte Black | NECU No Electrical Cutout YECU Electrical Cutout - add \$34 |

Veneer

| Model | Top Surface/Chassis/Door Front | Locking | Grommet | Electrical Cutout |
|-------|---|---|--|--|
| | see Anthology Top Surface/Chassis/Door Front Finishes see Contrasting Painted Door Front Colors Painted Door Front Upcharge - add \$365 | NLK No Locking YLK Locking - add \$53 per door set ASL Arctic Silver MBK Matte Black | NGR No Grommet YGR Two Grommets - add \$116 ASL Arctic Silver MBK Matte Black | NECU No Electrical Cutout YECU Electrical Cutout - add \$34 |

| Description | D | W | H | CTN WT | CU FT | ① Model | Laminate T | ESS Veneer V | ART Veneer V |
|--|----|----|----------|--------|-------|----------------------|------------|--------------|--------------|
| Buffet Credenza on Inset Panel Base | 20 | 36 | 35 15/16 | 137 | 21 | 65C203636CBP_ | \$2,158 | \$2,914 | \$3,205 |
| | 20 | 60 | 35 15/16 | 221 | 33 | 65C206036CBP_ | \$2,807 | \$3,729 | \$4,102 |
| | 20 | 72 | 35 15/16 | 262 | 39 | 65C207236CBP_ | \$2,910 | \$3,847 | \$4,232 |
| | 20 | 90 | 35 15/16 | 327 | 49 | 65C209036CBP_ | \$3,195 | \$4,202 | \$4,622 |

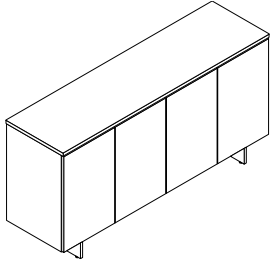

- 110° hinge doors
- touch latch doors
- one adjustable shelf per compartment
- unfinished back, includes cutout in back side for wire management pass through
- utility drawer 65C1727UD_ available order separately

| | | | | | | | | | |
|--|----|----|----------|-----|----|----------------------|---------|---------|---------|
| Conference Credenza on Inset Panel Base | 20 | 36 | 28 15/16 | 128 | 17 | 65C203629CCP_ | \$2,110 | \$2,859 | \$3,144 |
| | 20 | 60 | 28 15/16 | 195 | 27 | 65C206029CCP_ | \$2,701 | \$3,602 | \$3,963 |
| | 20 | 72 | 28 15/16 | 230 | 32 | 65C207229CCP_ | \$2,810 | \$3,752 | \$4,128 |
| | 20 | 90 | 28 15/16 | 287 | 40 | 65C209029CCP_ | \$3,096 | \$4,136 | \$4,549 |

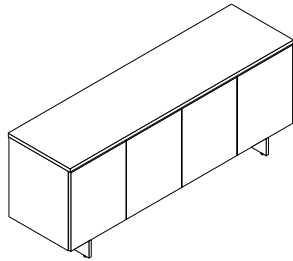

- 110° hinge doors
- touch latch doors
- one adjustable shelf per compartment
- unfinished back, includes cutout in back side for wire management pass through

| | | | | | | | | | |
|--|----|----|----------|-----|----|----------------------|---------|---------|---------|
| Low Height Credenza on Inset Panel Base | 20 | 36 | 23 15/16 | 107 | 14 | 65C203624CLP_ | \$2,009 | \$3,732 | \$4,105 |
| | 20 | 60 | 23 15/16 | 176 | 23 | 65C206024CLP_ | \$2,362 | \$3,138 | \$3,451 |
| | 20 | 72 | 23 15/16 | 205 | 27 | 65C207224CLP_ | \$2,494 | \$3,436 | \$3,780 |
| | 20 | 90 | 23 15/16 | 261 | 34 | 65C209024CLP_ | \$2,626 | \$3,735 | \$4,108 |

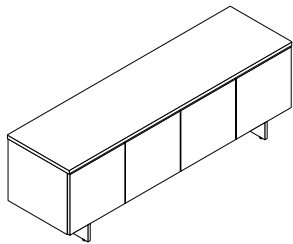

- 110° hinge doors
- touch latch doors
- unfinished back, includes cutout in back side for wire management pass through

Laminate

| Model | Top Surface TFL Laminate | Chassis Laminate | Door Laminate | Locking | Grommet | Electrical Cutout |
|-------|---|---|---|---|--|--|
| | see Anthology Top Surface TFL Laminate Finishes | see Anthology Chassis Laminate Finishes | see Anthology Laminate Finishes | NLK No Locking YLK Locking - add \$53 per door set ASL Arctic Silver MBK Matte Black | NGR No Grommet YGR Two Grommets - add \$116 ASL Arctic Silver MBK Matte Black | NECU No Electrical Cutout YECU Electrical Cutout - add \$34 |

Veneer

| Model | Top Surface/Chassis/Door Front | Locking | Grommet | Electrical Cutout |
|-------|---|---|--|--|
| | see Anthology Top Surface/Chassis/Door Front Finishes see Contrasting Painted Door Front Colors Painted Door Front Upcharge - add \$365 | NLK No Locking YLK Locking - add \$53 per door set ASL Arctic Silver MBK Matte Black | NGR No Grommet YGR Two Grommets - add \$116 ASL Arctic Silver MBK Matte Black | NECU No Electrical Cutout YECU Electrical Cutout - add \$34 |

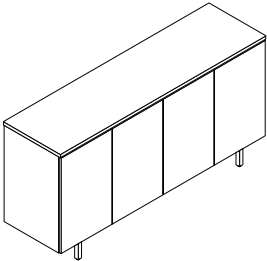
| Description | D | W | H | CTN WT | CU FT | ① Model | Laminate T | ESS Veneer V | ART Veneer V |
|--|----|----|----------|--------|-------|----------------------|----------------|----------------|----------------|
| Buffet Credenza on Inset Metal Base  | 20 | 36 | 35 15/16 | 143 | 21 | 65C203636CBM_ | \$3,679 | \$3,962 | \$4,358 |
| | 20 | 60 | 35 15/16 | 225 | 33 | 65C206036CBM_ | \$4,455 | \$5,377 | \$5,914 |
| | 20 | 72 | 35 15/16 | 264 | 39 | 65C207236CBM_ | \$4,690 | \$5,655 | \$6,221 |
| | 20 | 90 | 35 15/16 | 328 | 49 | 65C209036CBM_ | \$4,925 | \$5,934 | \$6,527 |

- 110° hinge doors
- touch latch doors
- one adjustable shelf per compartment
- unfinished back, includes cutout in back side for wire management pass through
- utility drawer 65C1727UD_ available order separately

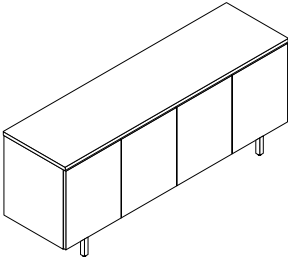
| | | | | | | | | | |
|--|----|----|----------|-----|----|----------------------|----------------|----------------|----------------|
| Conference Credenza on Inset Metal Base  | 20 | 36 | 28 15/16 | 134 | 17 | 65C203629CCM_ | \$3,630 | \$4,848 | \$5,333 |
| | 20 | 60 | 28 15/16 | 199 | 27 | 65C206029CCM_ | \$4,473 | \$5,251 | \$5,777 |
| | 20 | 72 | 28 15/16 | 232 | 32 | 65C207229CCM_ | \$4,587 | \$5,559 | \$6,116 |
| | 20 | 90 | 28 15/16 | 288 | 40 | 65C209029CCM_ | \$4,827 | \$5,867 | \$6,453 |

- 110° hinge doors
- touch latch doors
- one adjustable shelf per compartment
- unfinished back, includes cutout in back side for wire management pass through

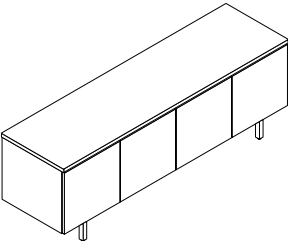
| | | | | | | | | | |
|--|----|----|----------|-----|----|----------------------|----------------|----------------|----------------|
| Low Height Credenza on Inset Metal Base  | 20 | 36 | 23 15/16 | 113 | 14 | 65C203624CLM_ | \$3,529 | \$4,313 | \$4,745 |
| | 20 | 60 | 23 15/16 | 180 | 23 | 65C206024CLM_ | \$4,011 | \$4,786 | \$5,265 |
| | 20 | 72 | 23 15/16 | 207 | 27 | 65C207224CLM_ | \$4,183 | \$5,126 | \$5,639 |
| | 20 | 90 | 23 15/16 | 262 | 34 | 65C209024CLM_ | \$4,793 | \$5,467 | \$6,013 |

- 110° hinge doors
- touch latch doors
- unfinished back, includes cutout in back side for wire management pass through

Laminate

| Model | Top Surface Laminate | Door Laminate | Locking | Metal Frame Colors | Grommet | Electrical Cutout |
|-------|---|---|---|---|--|--|
| | see Anthology Laminate Finishes | see Anthology Laminate Finishes | NLK No Locking YLK Locking - add \$53 per door set ASL Arctic Silver MBK Matte Black | Standard Metal Frame Colors see Anthology Standard Metal Frame Colors Additional Metal Frame Colors - add \$52 see Anthology Additional Metal Frame Colors Chrome Metal Base Upcharge - add \$773 | NGR No Grommet YGR Two Grommets - add \$116 ASL Arctic Silver MBK Matte Black | NECU No Electrical Cutout YECU Electrical Cutout - add \$34 |

Veneer

| Model | Top Surface/Chassis/Door Front | Locking | Metal Frame Colors | Grommet | Electrical Cutout |
|-------|---|---|---|--|--|
| | see Anthology Top Surface/Chassis/Door Front Finishes see Contrasting Painted Door Front Colors Painted Door Front Upcharge - add \$365 | NLK No Locking YLK Locking - add \$53 per door set ASL Arctic Silver MBK Matte Black | Standard Metal Frame Colors see Anthology Standard Metal Frame Colors Additional Metal Frame Colors - add \$52 see Anthology Additional Metal Frame Colors Chrome Metal Base Upcharge - add \$773 | NGR No Grommet YGR Two Grommets - add \$116 ASL Arctic Silver MBK Matte Black | NECU No Electrical Cutout YECU Electrical Cutout - add \$34 |

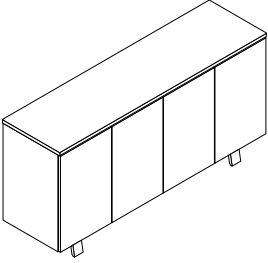
| Description | D | W | H | CTN WT | CU FT | Model | Laminate T | ESS Veneer V | ART Veneer V |
|---|----|----|--------|--------|-------|----------------------|------------|--------------|--------------|
| Buffet Credenza on Inset Wood Base  | 20 | 36 | 35 1/6 | 142 | 21 | 65C203636CBW_ | \$2,864 | \$3,700 | \$4,070 |
| | 20 | 60 | 35 1/6 | 224 | 33 | 65C206036CBW_ | \$3,512 | \$4,848 | \$5,333 |
| | 20 | 72 | 35 1/6 | 263 | 39 | 65C207236CBW_ | \$3,189 | \$4,057 | \$4,462 |
| | 20 | 90 | 35 1/6 | 326 | 49 | 65C209036CBW_ | \$3,899 | \$4,900 | \$5,389 |

- 110° hinge doors
- touch latch doors
- one adjustable shelf per compartment
- unfinished back, includes cutout in back side for wire management pass through
- utility drawer 65C1727UD_ available order separately

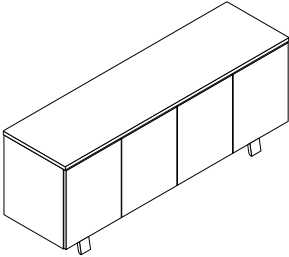
| | | | | | | | | | |
|---|----|----|--------|-----|----|----------------------|---------|---------|---------|
| Conference Credenza on Inset Wood Base  | 20 | 36 | 28 1/6 | 133 | 17 | 65C203629CCW_ | \$2,814 | \$3,644 | \$4,007 |
| | 20 | 60 | 28 1/6 | 198 | 27 | 65C206029CCW_ | \$3,406 | \$4,301 | \$4,730 |
| | 20 | 72 | 28 1/6 | 231 | 32 | 65C207229CCW_ | \$3,398 | \$4,568 | \$5,025 |
| | 20 | 90 | 28 1/6 | 286 | 40 | 65C209029CCW_ | \$3,800 | \$4,834 | \$5,318 |

- 110° hinge doors
- touch latch doors
- one adjustable shelf per compartment
- unfinished back, includes cutout in back side for wire management pass through

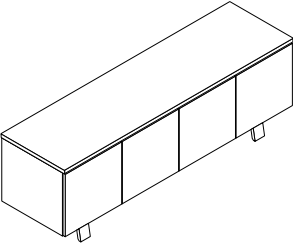
| | | | | | | | | | |
|---|----|----|--------|-----|----|----------------------|---------|---------|---------|
| Low Height Credenza on Inset Wood Base  | 20 | 36 | 23 1/6 | 112 | 14 | 65C203624CLW_ | \$2,715 | \$3,579 | \$3,937 |
| | 20 | 60 | 23 1/6 | 179 | 23 | 65C206024CLW_ | \$3,068 | \$3,836 | \$4,220 |
| | 20 | 72 | 23 1/6 | 206 | 27 | 65C207224CLW_ | \$3,105 | \$4,009 | \$4,411 |
| | 20 | 90 | 23 1/6 | 260 | 34 | 65C209024CLW_ | \$3,330 | \$4,985 | \$5,483 |

- 110° hinge doors
- touch latch doors
- unfinished back, includes cutout in back side for wire management pass through

Laminate

| Model | Top Surface Laminate | Door Laminate | Base Finish | Locking | Grommet | Electrical Cutout |
|-------|---------------------------------|---------------------------------|----------------------------------|---|--|--|
| | see Anthology Laminate Finishes | see Anthology Laminate Finishes | see Anthology Base Wood Finishes | NLK No Locking YLK Locking - add \$53 per door set ASL Arctic Silver MBK Matte Black | NGR No Grommet YGR Two Grommets - add \$116 ASL Arctic Silver MBK Matte Black | NECU No Electrical Cutout YECU Electrical Cutout - add \$34 |

Veneer

| Model | Top Surface/Chassis/Door Front | Base Finish | Locking | Grommet | Electrical Cutout |
|-------|---|----------------------------------|---|--|--|
| | see Anthology Top Surface/Chassis/Door Front Finishes see Contrasting Painted Door Front Colors Painted Door Front Upcharge - add \$365 | see Anthology Base Wood Finishes | NLK No Locking YLK Locking - add \$53 per door set ASL Arctic Silver MBK Matte Black | NGR No Grommet YGR Two Grommets - add \$116 ASL Arctic Silver MBK Matte Black | NECU No Electrical Cutout YECU Electrical Cutout - add \$34 |

| Description | D | W | H | CTN WT | CU FT | ① Model | List Price |
|---|-----|-----|-----|-----------|----------|---------------|--------------|
| Glenbeigh Electrical Single Unit Power + Open - Corded | 4 ¼ | 5 ¼ | 1 ⅞ | 3 | 1 | 9PCK1C | \$395 |

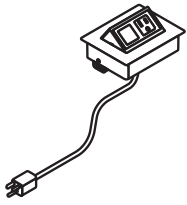

- In-Surface metal frame with retractable one touch doors
- one power and one open data port. Accepts TCP300 Telecom ports ordered separately. 12 pack data adapter kit included
- 10' cord with 15 amp three-prong molded plug
- powdercoat Silver or Black
- UL Listed

| | | | | | | | |
|--|-----|-----|-----|---|---|---------------|--------------|
| Glenbeigh Electrical Single Unit Power - Corded | 4 ¼ | 5 ¼ | 1 ⅞ | 3 | 1 | 9PCK2C | \$401 |
|--|-----|-----|-----|---|---|---------------|--------------|

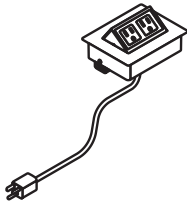

- In-Surface metal frame with retractable one touch doors
- two Power
- 10' cord with 15 amp three-prong molded plug
- powdercoat Silver or Black
- UL Listed

| | | | | | | | |
|--|-----|-----|-----|---|---|----------------|--------------|
| Glenbeigh Electrical Single Unit Power + USB - Corded | 4 ¼ | 5 ¼ | 1 ⅞ | 3 | 1 | 9PCK11C | \$473 |
|--|-----|-----|-----|---|---|----------------|--------------|

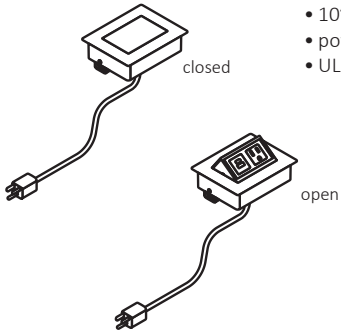

- In-Surface metal frame with retractable one touch doors
- one Power, one USB A + C (10 watt each)
- 10' cord with 15 amp three-prong molded plug
- powdercoat Silver or Black
- UL Listed

Model | Metal Finish

- B** Black
- S** Silver

| Description | D | W | H | CTN WT | CU FT | ① Model | List Price |
|-------------------------------|--------|----|-------|-----------|----------|-------------------|----------------|
| Thermostat Control Fan | 10 7/8 | 19 | 1 3/4 | 5 | 1 | 65C1019TCF | \$1,655 |

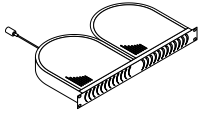

- black brushed and anodized
- quiet blower panel airflow: 100CFM
- current draw: 840mA
- sound level: 32dBA
- static pressure: 0.31 IN H2O
- includes UL Listed 12V DC power supply and temperature probe with a 9' cord
- blower panel activates at 87°F, full speed reach at 95°F, switch off at 85°F
- use with the Equipment Credenza models

| | | | | | | | |
|----------------------------------|--------|--------|----|----|---|-----------------|----------------|
| Rotating Pull Out AV Rack | 19 3/4 | 19 3/8 | 24 | 55 | 5 | 65C19PAV | \$3,222 |
|----------------------------------|--------|--------|----|----|---|-----------------|----------------|

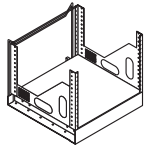

- black metal
- features slide out and rotating base
- recommended to use in conjunction with the thermostat control fan
- use with the Equipment Credenza models

| | | | | | | | |
|--|--------|--------|----|----|---|-------------------|--------------|
| Pull Out Dual Waste, Recycle Unit | 21 3/4 | 14 1/4 | 19 | 18 | 6 | 65C2214PDW | \$293 |
|--|--------|--------|----|----|---|-------------------|--------------|

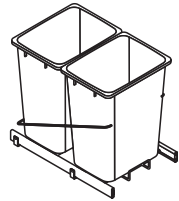

- dual 36 quart, plastic grey
- bottom mounted, soft close, steel, chrome
- use with the Equipment Credenza models

| | | | | | | | |
|--------------------------------|--------|----|-------|----|---|-------------------|--------------|
| Laminate Utility Drawer | 17 1/4 | 27 | 2 1/2 | 12 | 2 | 65C1727UDT | \$374 |
|--------------------------------|--------|----|-------|----|---|-------------------|--------------|

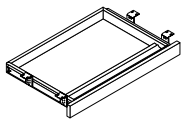

- use with Buffet Credenza models

| Description | D | W | H | CTN WT | CU FT | ① Model | Essentials Veneer | Artisan Veneer |
|------------------------------|--------|----|-------|-----------|----------|-------------------|----------------------|-------------------|
| Veneer Utility Drawer | 17 3/8 | 27 | 2 1/2 | 12 | 2 | 65C1727UDV | \$458 | \$504 |

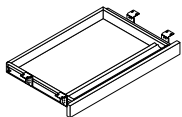

- use with Buffet Credenza models

| Model | Laminate for Utility Drawer | Veneer for Utility Drawer |
|-------|---|---|
| | see Anthology Laminate Finishes | see Anthology Veneer Finishes |