

Lok Teamwork Top Shapes

Lok offers 24 teamwork table top shapes. Tables are available in 29", 36" or 42" high and in laminate or veneer. Compatible bases are: T Base or X Base



Rectangular
29"h

- 36" x 60" Seats 4
- 36" x 66" Seats 6
- 36" x 72" Seats 6
- 42" x 72" Seats 6
- 48" x 72" Seats 6

- 36"h**
- 36" x 60" Seats 4
 - 36" x 66" Seats 6
 - 36" x 72" Seats 6
 - 42" x 72" Seats 6
 - 48" x 72" Seats 6

- 42"h**
- 36" x 60" Seats 4
 - 36" x 66" Seats 6
 - 36" x 72" Seats 6
 - 42" x 72" Seats 6
 - 48" x 72" Seats 6



Rounded Rectangular
29"h

- 36" x 60" Seats 4
- 36" x 66" Seats 6
- 36" x 72" Seats 6
- 42" x 72" Seats 6
- 48" x 72" Seats 6

- 36"h**
- 36" x 60" Seats 4
 - 36" x 66" Seats 6
 - 36" x 72" Seats 6
 - 42" x 72" Seats 6
 - 48" x 72" Seats 6

- 42"h**
- 36" x 60" Seats 4
 - 36" x 66" Seats 6
 - 36" x 72" Seats 6
 - 42" x 72" Seats 6
 - 48" x 72" Seats 6

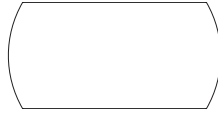

Arc Rectangular
29"h

- 36" x 60" Seats 4
- 36" x 66" Seats 6
- 36" x 72" Seats 6
- 42" x 72" Seats 6
- 48" x 72" Seats 6

- 36"h**
- 36" x 60" Seats 4
 - 36" x 66" Seats 6
 - 36" x 72" Seats 6
 - 42" x 72" Seats 6
 - 48" x 72" Seats 6

- 42"h**
- 36" x 60" Seats 4
 - 36" x 66" Seats 6
 - 36" x 72" Seats 6
 - 42" x 72" Seats 6
 - 48" x 72" Seats 6



Rounded Arc Rectangular
29"h

- 36" x 60" Seats 4
- 36" x 66" Seats 6
- 36" x 72" Seats 6
- 42" x 72" Seats 6
- 48" x 72" Seats 6

- 36"h**
- 36" x 60" Seats 4
 - 36" x 66" Seats 6
 - 36" x 72" Seats 6
 - 42" x 72" Seats 6
 - 48" x 72" Seats 6

- 42"h**
- 36" x 60" Seats 4
 - 36" x 66" Seats 6
 - 36" x 72" Seats 6
 - 42" x 72" Seats 6
 - 48" x 72" Seats 6



Racetrack
29"h

- 36" x 60" Seats 4
- 36" x 66" Seats 6
- 36" x 72" Seats 6
- 42" x 72" Seats 6
- 48" x 72" Seats 6

- 36"h**
- 36" x 60" Seats 4
 - 36" x 66" Seats 6
 - 36" x 72" Seats 6
 - 42" x 72" Seats 6
 - 48" x 72" Seats 6

- 42"h**
- 36" x 60" Seats 4
 - 36" x 66" Seats 6
 - 36" x 72" Seats 6
 - 42" x 72" Seats 6
 - 48" x 72" Seats 6

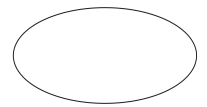

Oval
29"h

- 36" x 72" Seats 6

- 36"h**
- 36" x 72" Seats 6

- 42"h**
- 36" x 72" Seats 6



Boat
29"h

- 36" x 60" Seats 4
- 36" x 66" Seats 6
- 36" x 72" Seats 6
- 42" x 72" Seats 6
- 48" x 72" Seats 6

- 36"h**
- 36" x 60" Seats 4
 - 36" x 66" Seats 6
 - 36" x 72" Seats 6
 - 42" x 72" Seats 6
 - 48" x 72" Seats 6

- 42"h**
- 36" x 60" Seats 4
 - 36" x 66" Seats 6
 - 36" x 72" Seats 6
 - 42" x 72" Seats 6
 - 48" x 72" Seats 6



Rounded Boat
29"h

- 36" x 60" Seats 4
- 36" x 66" Seats 6
- 36" x 72" Seats 6
- 42" x 72" Seats 6
- 48" x 72" Seats 6

- 36"h**
- 36" x 60" Seats 4
 - 36" x 66" Seats 6
 - 36" x 72" Seats 6
 - 42" x 72" Seats 6
 - 48" x 72" Seats 6

- 42"h**
- 36" x 60" Seats 4
 - 36" x 66" Seats 6
 - 36" x 72" Seats 6
 - 42" x 72" Seats 6
 - 48" x 72" Seats 6

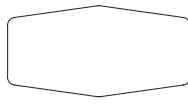

Rounded Double Chevron
29"h

- 36" x 60" Seats 4
- 36" x 72" Seats 6
- 42" x 72" Seats 6
- 48" x 72" Seats 6

- 36"h**
- 36" x 60" Seats 4
 - 36" x 72" Seats 6
 - 42" x 72" Seats 6
 - 48" x 72" Seats 6

- 42"h**
- 36" x 60" Seats 4
 - 36" x 72" Seats 6
 - 42" x 72" Seats 6
 - 48" x 72" Seats 6



Lok Teamwork Top Shapes

Lok offers 24 teamwork table top shapes. Tables are available in 29", 36" or 42" high and in laminate or veneer. Compatible bases are: T Base or X Base

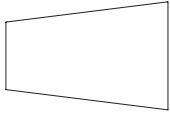

Taper
29"h
48" x 72" Seats 6

36"h
48" x 72" Seats 6

42"h
48" x 72" Seats 6

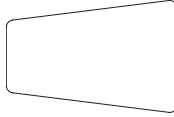

Rounded Taper
29"h
48" x 72" Seats 6

36"h
48" x 72" Seats 6

42"h
48" x 72" Seats 6

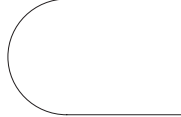

Bullet
29"h
48" x 72" Seats 6

36"h
48" x 72" Seats 6

42"h
48" x 72" Seats 6



Hive
29"h
48" x 72" Seats 6

36"h
48" x 72" Seats 6

42"h
48" x 72" Seats 6



Wedge
29"h
48" x 72" Seats 6

36"h
48" x 72" Seats 6

42"h
48" x 72" Seats 6



Rounded Wedge
29"h
48" x 72" Seats 6

36"h
48" x 72" Seats 6

42"h
48" x 72" Seats 6



Lok Teamwork Laminate Surface Materials

Laminate Tops

HPL tops are 1 3/8" thick, 3 ply balanced construction. The laminate face is horizontal grade high pressure laminate. Particle board core and a phenolic backer sheet complete the balanced construction.

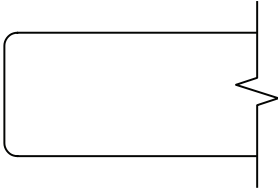

Eased Edge (R3)
PVC

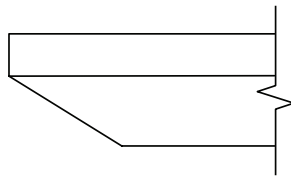

Reverse Bevel (K9)
PVC on painted top of painted MDF

Standard PVC Edge Colors

JSI supports 26 standard PVC edge colors listed below. These coordinate with our Standard (T1) Laminates.

When selecting a Standard (T1) Laminate, the coordinating PVC edge color is automatically applied. When selecting a Graded-In T2 Laminate, you will be prompted to choose one these 26 PVC edge colors to be applied; see web-site for updated Graded-In Laminate list.

ALB	Alabaster	MES	Mesa
BEL	Belair	MIN	Mineral
BLK	Black	MCH	Mocha
BRK	Brickdust	OBK	Outback
BBL	Bridal Blanco	PIL	Pilsner
CSK	Cask	PIN	Pinnacle Walnut
CLY	Clay	SHD	Shadow
DWH	Designer White	SLG	Slate Grey
EGR	Egret	UMB	Umber
FAW	Fawn	VAL	Valley
FLN	Flint	WAL	Walnut Heights
FLO	Florence Walnut	WEA	Weathered Ash
LOF	Loft	ZEN	Zen Grey

Standard Laminates

JSI Standard Laminate program consists of 26 solid and wood grain patterns, and establish our T1 laminate pricing. Each has a coordinating PVC edge color that is automatically used with the Standard Laminates.

Wood Grain Laminate

BEL	Belair	MIN	Mineral
BRK	Brickdust	MCH	Mocha
CSK	Cask	OBK	Outback
CLY	Clay	PIL	Pilsner
EGR	Egret	PIN	Pinnacle Walnut
FAW	Fawn	UMB	Umber
FLN	Flint	VAL	Valley
FLO	Florence Walnut	WLH	Walnut Heights
LOF	Loft	WEA	Weathered Ash
MES	Mesa		

Solid Laminate

ALB	Alabaster
BLK	Black
BBL	Bridal Blanco
DWH	Designer White
SHD	Shadow
SLG	Slate Grey
ZEN	Zen Grey



Lok Teamwork Veneer Surface Materials

Veneer Tops

Tops are 1 3/16" thick, 5 ply balanced construction with particle board core. Standard Tier 1 veneer is essentials, book matched for cherry, maple, walnut and black oak veneer. Standard Tier 2 veneer is Artisan.

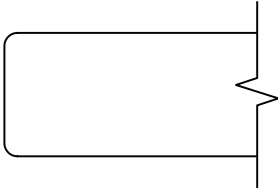

Eased Edge (R3)
Internal Lumber Band

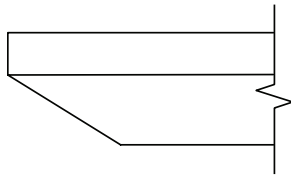

Reverse Bevel (K9)
Veneer Band on Stained MDF

Finish - Stain/Colors

ESS Essentials Veneer Collection

BRK	Brickdust	MIN	Mineral
CSK	Cask	MCH	Mocha
CLY	Clay	OBK	Outback
FAW	Fawn	PIL	Pilsner
FLX	Flax	SIE	Sienna
FLN	Flint	TRF	Truffle
LOF	Loft	UMB	Umber
MES	Mesa	VAL	Valley

ART Artisan Veneer Collection

BAR	Barrel	RAV	Raven
BUF	Buff	RYE	Rye
CND	Cinder	SAB	Sable
EGR	Egret	SAD	Saddle



Lok Teamwork Base Styles

Lok provides a choice selection of bases in both function and aesthetics to serve a variety of needs. The teamwork offering includes: T-base and X-base

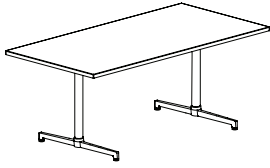

T-Base

- available in 29" with options of glide or caster
- available in 36"h and 42"h only in glides
- compatible with the following top shapes: arc rectangular, boat, bullet, double chevron, hive, racetrack, rectangular, taper, wedge
- base finish - select single metal finish or two-tone metal finish. See options listed below

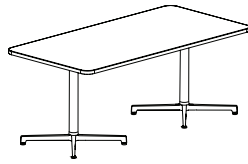

X-Base

- available in 16", 29"h, 36"h or 42"h only in glides
- compatible with the following top shapes: rectangular, round, square, squircle
- base finish - select single metal finish or two-tone metal finish. See options listed below

Single Metal Finish

- ABZ Aged Bronze Feet & Post
- ASL Arctic Silver Feet & Post
- GLD Gold Feet & Post
- PEW Pewter Feet & Post
- MBK Matte Black Feet & Post
- SBZ Soft Bronze Feet & Post
- SNK Soft Nickel Feet & Post

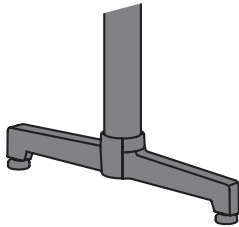

Two - Tone Metal Finish

Two-Tone Aesthetics can be achieved by specifying Polished Aluminum on the foot and a contrasting finish on the post

Polished Aluminum Feet

- ABZ Aged Bronze Post
- ASL Arctic Silver Post
- GLD Gold Post
- PEW Pewter Post
- MBK Matte Black Post
- SBZ Soft Bronze Post
- SNK Soft Nickel Post

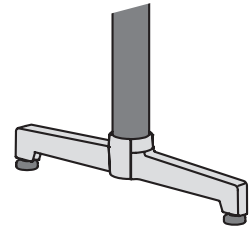

Power/Charging Options

Lok offers the ability to place power and charging options in the center of select tables. Select your choice of EC23 or EC24, available in black and white.

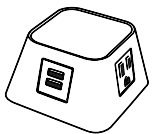

Moire - EC23

- Three 110 outlets
- Dual USB port with 72" power cord
- Black (B) or White (W)

select CTEC23 for cutout in worksurfaces



Node - EC24

- One 110 outlet
- Dual USB port with 72" power cord
- Black (B) or White (W)

select CTEC24 for cutout in worksurfaces

Cut outs are located in the center of each table. See below for representation or location.

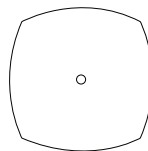
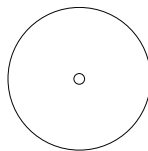
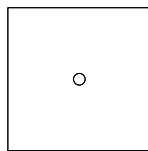
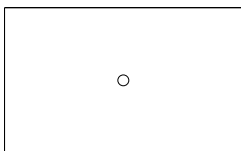

Lok Electrical

Overview

Lok provides several packages to choose from for your electrical needs. Choose solutions for top surface power, underneath outlets, wireless charging, or a combination.

Specifying an electrical package eliminates your need to calculate additional components, as all units and necessary jumpers will ship with your table. **You will only need to determine which power in-feed best suits your needs and order separately.**

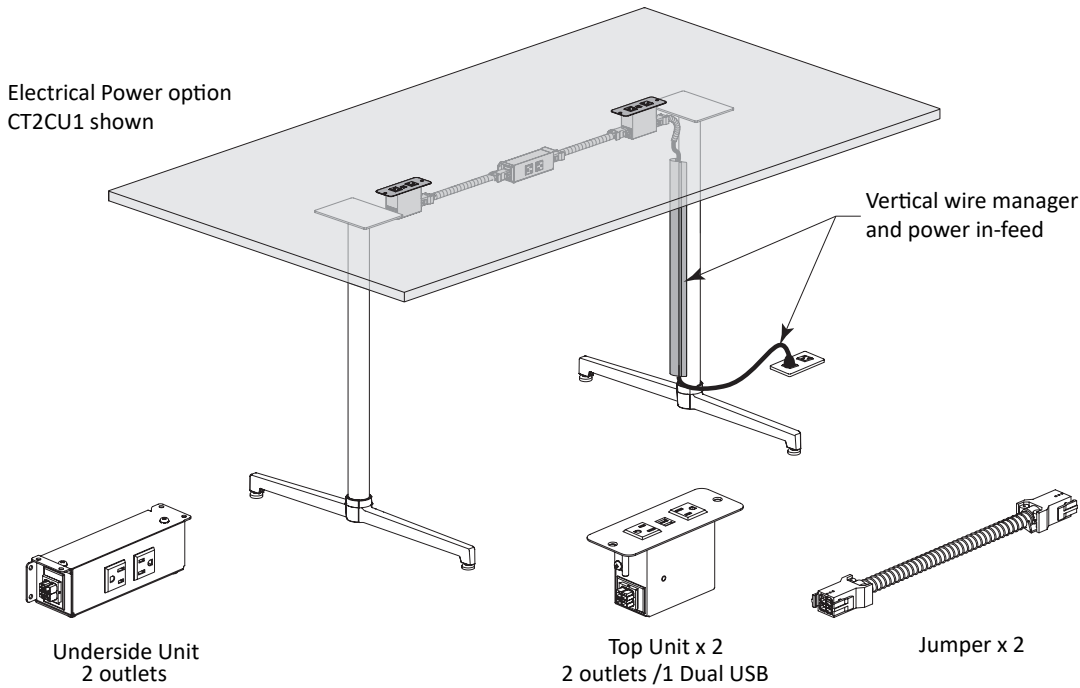

Electrical

Power and Charging Packages are measured and located out from the center of the table. Shown on rectangular tops, these dimensions are the same from center regardless of table shape. **Power in-feed is specified separately to support building electrical connection.**

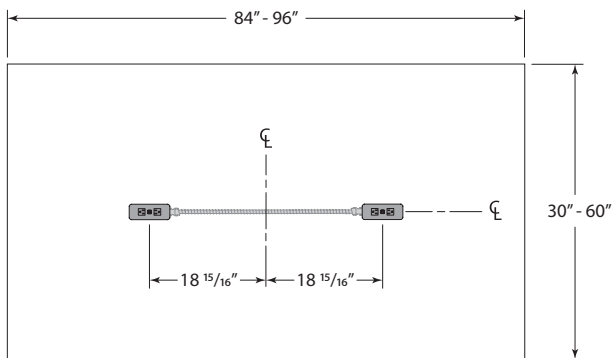

CT2 - Dual Power Top of Surface

