



Model # Shown 01144

OVERVIEW

Embrace the future of education with this affordable and adaptable activity table, designed to cultivate a dynamic and engaging classroom environment. This thoughtfully crafted table combines durability with functionality, providing an ideal solution for dynamic and collaborative educational environments. The Foresight line features a variety of fun shapes. Mix up collaborative spaces with stars, trapezoids, squares, moons, sprockets and interlocking Yin-Yang designs.

MATERIALS

The 1 1/4" thick work surface consists of a 45 lb density particle board core with a 0.030" high pressure laminated surface and a 0.020" melamine backer sheet. The edge of the tabletop features your choice of a 3/8" bumper t-mold or 4mm t-mold, which is then fastened to the underside of the work surface every 6 to 8 inches to assure a long lasting fit.

The Foresight line is available in a 15.6 -24.6"H leg and a 21.4 -30.4"H leg that will work from PreK all the way to higher ed learners.

TOP AND EDGE OPTIONS:

1 1/4" TOP W/ BUMPER T-MOLD
NO LETTER TO FOLLOW MODEL NO.

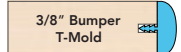

1 1/4" TOP W/ 3MM - 90° CORNERS
H

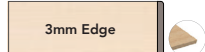

1 1/4" TOP W/ 4MM T-MOLD
D

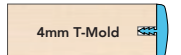

1 1/4" TOP W/ 3MM - ROUND CORNERS
F

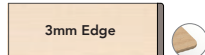

DIMENSIONS

Model	Description	D"	W"	H"	WT
01143	Foresight Kidney Activity Table <i>Standard Leg</i>	48	72	21.34 - 30.4	113.8
01144	Foresight Kidney Activity Table <i>Low Leg</i>	48	72	15.6 - 24.6	112.5

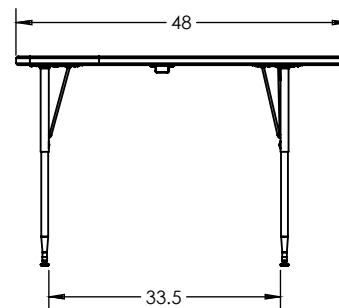
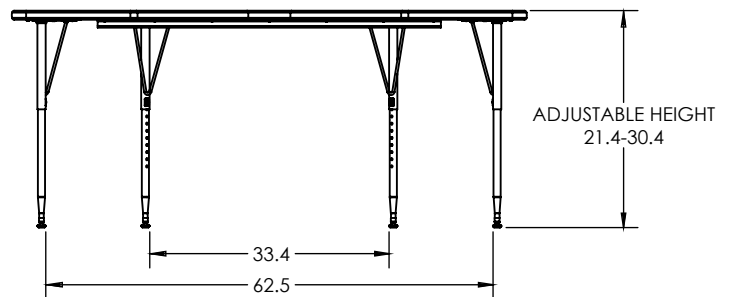
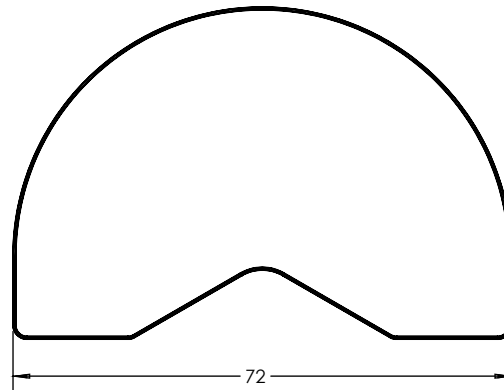

STANDARD LAMINATE OPTIONS

Want to specify a different laminate?

No problem. If you have 20 or more tops of the same color -60 or -38 there is no upcharge. Have 20 or less? We can quote for you with the Wilsonart code and – finish style. We can specify other laminates – call to inquire and get a quote.

SUGGESTED SURFACE LAMINATE OPTIONS



All 20 of the standard laminates are -60 finish, if you need to match a laminate from a previous year, please let us know on your order (example Pewter Mesh 4878-38, our standard is -60).

When the WilsonArt Laminate code includes a "Y", "K", "-12", "-78", "Aeon" etc, these are special laminates with an upcharge, even when it contains -38 or -60.

STANDARD EDGE COLOR OPTIONS



LEG COLOR OPTIONS



EDGE COLOR OPTIONS WITH ADDITIONAL LEAD TIME

