

# Coalesse Surface Materials Reference Guide April 2026

## Availability

Electronic price list updated with release 204.B (U.S.) and 158.B (Canada), dated April 20, 2026.

All specifications subject to change without notice. Reference the electronic catalog/Hedberg for current pricing.

Transitional products in this specification guide are **maintained for existing customers only** and are likely to be phased out over time. These products are indicated with a **†**. Products that are scheduled to be culled are indicated with an **X**, followed by the last order entry date.

► For a list of all trademarks, refer to the last page of this specification guide. © 2026 Steelcase Inc.

*Note: Actual colors will vary due to printing process.*

<b>What's New in Surface Materials</b>	2
<b>Upholstery</b>	4
Customer's Own Material	6
Fabric Matrix	8
Upholstery Palette	9
<b>Leather/Faux</b>	18
Cut Yardage Net Price List	20
Leather and Faux Leather Matrix	21
Leather Palette	22
Faux Leather Palette	24
<b>Wood</b>	28
Solid Wood Matrix	30
Solid Wood Stains Palette	32
Veneer Matrix	33
Veneer Palette	34
<b>Laminate</b>	39
High-Pressure Laminate Matrix	40
High-Pressure Laminate Palette	44
Laminate Edge Band Matrix	48
Recommended Worksurface 3 mm Edge Finishes	52
<b>Glass</b>	54
Glass Matrix	55
Glass Palette	56
<b>Metal/Paint</b>	57
Custom Paint	58
Metal/Paints Matrix	60
Metal/Paints Palette	64
<b>Miscellaneous</b>	68
Enea and Enea Lottus Plastic Matrix	69
Plastic and Miscellaneous Palette	70
Exponents, Potrero415, Potrero415 Light, Sistema, and SW_1 Exclusives	73
<b>Care and Maintenance</b>	74



## For Canadian Pricing

Canadian factor can be found at [steelcase.com/CADpricing](http://steelcase.com/CADpricing).

Calculate in the following order to avoid rounding errors:

- Multiply the base price and each option by the Canadian factor.
- Round each to the nearest dollar.
- Add base and options for total list price.

# What's New in Surface Materials

Visit the **Finish Library** at <https://finishlibrary.steelcase.com/all-surfaces/brand/coalesse.html> or view the finish matrices to see list of availability, by product line. Samples can be purchased via Steelcase Marketing Resources.

## Coalesse Fabrics—June 2025

Coalesse fabric price grades 6-14 are moving to align with Steelcase price groups 1-10.

## Coalesse Partners—June 2021

All Coalesse partners surface material information has been moved to the new *Coalesse Partners Specification Guide*. With EMU content being housed in one specification guide, finding information on these partner products is now easier than ever.

## Steelcase Back-Painted Finishes—February 2020

We are enhancing our back-painted glass portfolio through the addition of color. The colors range from a harmonious pink to a new neutral blue. By refreshing these color palettes, we are providing added value through the range and depth of our material offering.

## Foundation, Steelcase Surfaces—December 2019

New FR-free vinyl, Foundation launches. Free of harmful phthalates, Foundation is a non-woven, high-performing, bleach-cleanable material, and is perfect for our education and health environments. Foundation is available in 14 colors at Price Group 6.

## New Accent Paints, Steelcase Surfaces—December 2019

Six new trend driven paints have been added to the Steelcase accent paint palette.

## Coalesse Standard Color Paints—October 2019

Seven textured paints that draw from the Coalesse color point-of-view and its restorative tone of nature have been added as a Group 1 paint to many of our best-selling product lines.

## Refreshed LessThanFive Color Palette—October 2019

Eight new matte finishes have been added to LessThanFive that align with the Coalesse color point-of-view and its biophilic tones from nature.

## LessThanFive Essential—October 2019

Four new neutral matte finishes have been added to LessThanFive Essential, sold in multi-packs of two or four at a reduced price point per chair.

## PerfectMatch, Custom Paint—October 2019

Coalesse Color empowers more personal expression by expanding color choices through our custom capabilities program. For select, preset Coalesse products, we have improved the process to make it even easier to order. Once the color match process is complete and the special paint finish code has been assigned, order with a Group 3 paint upcharge. For more information, review *Custom Paints* on page 58.

## Lux Coatings, Steelcase Surfaces—October 2019

Steelcase Lux Coatings has been added to even more product lines and is now available as a Group 3 paint upcharge.

## Accent Paints, Steelcase Surfaces—October 2019

Trend driven Steelcase accent paints have been added to many of our best-selling product lines. Accent paints are now offered as a Group 3 paint upcharge.

## Coalesse Standard Glass Finishes—October 2019

Previously available on Potrero415 only, six back-painted glass finishes are now available as standard on all product lines with back-painted glass. Four nature inspired and two neutral finish additions complement the existing glass palette – bringing more choice.

In addition, new frosted glass finish 6511 Acid Etched is now available to order, replacing ACF Absolute Clear Frosted (culled in June 2020). For details, please refer to page 54.

# What's New in Surface Materials

# Upholstery Coalesse

## Upholstery

All Coalesse textiles are priced by groups. Some Coalesse fabrics can be treated for flame retardancy; contact Customer Service. All Coalesse products are handcrafted, making each unique. Certain fabrics and leathers will appear loose and may differ from like products due to comfort wrinkles when upholstered.

A contrasting welt is available on some products. Consult Customer Service for yardage or square feet requirements and prices. All stripes will be applied vertically unless customer specifies otherwise. Loose cushions on Coalesse products are not fully upholstered (not reversible).

Coalesse offers select fabrics from the following manufacturers grouped in our pricing:

- Designtex
- Maharam
- Kvadrat
- Camira
- Gabriel
- Conneaut
- Moore & Giles
- Steelcase

Simply select one of the above manufacturers and available fabric finishes during specification. Coalesse does not stock graded-in fabrics and can only respond based on availability and lead times from the above manufacturers. For current groups, fabric families, and product availability, refer to the Coalesse fabric database: [fabric.coalesse.com](http://fabric.coalesse.com).

## Special Fabric Applications\*

### Backing\*

- Backing information is found on each product page in the Coalesse Specification Guides. Select this option when ordering your product to have backing applied. Price varies by product according to yardage it requires.

\*Prices subject to change without notice and an additional two week lead time will apply for 54" wide fabrics. Wider fabrics will require four week additional lead time. \*Check fabric database to determine if backing is required at [www.Coalesse.com](http://www.Coalesse.com).

## Coalesse Upholstery

Coalesse fabrics are priced by groups from 1 through 10 and leathers 1 and 2. Fabrics and leathers may be purchased separately as cut yardage, see page 20. All products are handcrafted, making each unique. Certain fabrics and leathers will appear loose and may differ from like products due to wrinkles when upholstered. A contrasting welt is available on some products. Consult Customer Service for yardage or square feet requirements for pricing.

All stripes will be applied vertically unless customer specifies otherwise. Loose cushions on Coalesse products are not fully upholstered (not reversible). Any Select Surface or COM textile should be reviewed with supplier to verify availability. In some cases a textile supplier may require minimums that exceed your furniture order requirements. In these situations, you will be contacted with an option to select a different textile or continue with your original textile selection as a COM-DTP. If you choose to continue with your textile selection as COM-DTP to allow you to order the minimum required, please ship only the textile needed to Coalesse for your furniture order.

## SW\_1 Knit

### Applies to: SW\_1 Collection

- 5KG0 Sand
- 5KG1 Silver
- 5KG3 Black
- 5KG4 Ivory
- 5KG5 Coal
- 5KG6 Fire
- 5KG9 Pewter
- 5KH0 Ice
- 5KH1 Currant
- 5KH2 Ocean
- 5KH3 Silver Grey
- 5KH4 Olive
- 5KH5 Blue Ink
- 5KH6 Blue Bird
- 5KH7 Blush
- 5KH8 Goldenrod
- 5KH9 Leaf

## Lagunitas Knit

### Applies to: Lagunitas Focus nook and lounge system

- Group 1**
- 5K50 Sand
  - 5K51 Silver
  - 5K52 Pewter
  - 5K54 Black
  - 5K58 Ivory
  - 5K59 Coal
  - 5K70 Silver Grey

- Group 2**
- 5K55 Fire
  - 5K60 Ice
  - 5K61 Ocean
  - 5K63 Leaf
  - 5K67 Currant
  - 5K71 Olive
  - 5K72 Blue Ink
  - 5K73 Blue Bird
  - 5K74 Blush
  - 5K75 Goldenrod

## Hexa Upholstery

### Applies to: Hosu

- Group 4**
- CL50 Dark Grey
  - CL51 Light Grey
  - CL52 Blue
  - CL55 Yellow
  - CL70 Saffron
  - CL71 Rose Quartz
  - CL72 Lagoon
  - CL73 Sea Salt
  - CL74 Steam
  - CL75 Ocean
  - CL76 Sage

## Fusion Upholstery

### Applies to: Massaud work lounge

- Group 5**
- CL60 Caviar
  - CL62 Graphite
  - CL64 Steam\*
  - CL80 Terracotta
  - CL81 Copper
  - CL82 Sage
  - CL83 Blue Ink
  - CL84 Blue Steel

\* Not available on Hosu

# Upholstery Steelcase

## Steelcase Upholstery

Coalesse offers a select palette of Steelcase fabrics as standard. This provides the convenience of an integrated finish offering and ease of specification. See the Steelcase Standard Fabric Matrix for availability by product line.

### Group 1

#### Jacks **E**

- 5B61 Taupe
- 5B63 Camel
- 5B64 Pewter
- 5B70 Midnight

#### Link

- 5A24 Blue
- 5A25 Navy
- 5A27 Black

### Group 2

#### Cogent: Connect

- 5S15 Coconut
- 5S16 Turmeric/Honey
- 5S17 Tangerine
- 5S18 Scarlet
- 5S19 Concord
- 5S21 Blue Jay
- 5S23 Wasabi
- 5S24 Nickel
- 5S25 Graphite
- 5S26 Licorice
- 5S27 Malt
- 5S28 Root Beer
- 5S93 Indigo/Blueprint
- 5S94 Lizard/Jungle
- 5S95 Sailor
- 5S96 Quicksilver
- 5S99 Lipstick/Merlot
- 5SD0 Royal Blue
- 5SD1 Aubergine
- 5SD2 Peacock
- 5SD3 Lagoon
- 5SD4 Saffron
- 5SD5 Citrine
- 5SD6 Rose Quartz
- 5SD7 Sea Salt
- 5SF3 Storm Cloud
- 5SF4 Olivine

#### Dovetail by Designtex

- 5H39 Light Mocha
- 5H40 Pebble
- 5H41 Warm White
- 5H42 Sandstone
- 5H43 Honeycomb
- 5H44 Terra
- 5H45 Honeydew
- 5H46 Denim
- 5H47 Storm
- 5H48 Ice Blue
- 5H49 Aura
- 5H50 Darkest Grey

### Foundation

- 5875 Black
- 5876 Navy
- 5877 Foggy Night
- 5878 Sailor
- 5879 Ivory
- 5880 Seal
- 5881 Peat
- 5882 New Sand
- 5883 Cranberry
- 5884 Spring
- 5885 Honey
- 5886 Folkstone
- 5887 Pebble
- 5888 Oregano

### New Black

- 5J08 Jack
- 5J09 James
- 5J12 Harley

### SoftNext

- 5H27 Obsidian
- 5H28 Foggy Night
- 5H29 Greystone
- 5H30 Mocha
- 5H31 Clay
- 5H32 Sandstone
- 5H33 Chalk
- 5H34 Midnight
- 5H35 Blue Mica
- 5H36 Jade
- 5H37 Burnt Umber
- 5H38 Cinnabar

### Stand In

- 5621 Sleet
- 5622 Lunar
- 5623 Cyclone
- 5624 Eclipse
- 5625 Powder
- 5626 Chardonnay
- 5627 Graham
- 5628 Sediment
- 5629 Allspice
- 5630 Apple
- 5631 Lava
- 5632 Cayenne
- 5633 Plantain
- 5634 Parsley
- 5635 Scallion
- 5636 Atlantis
- 5691 Orca
- 5740 Burlap
- 5741 Porter
- 5742 Tusk
- 5743 Putty
- 5744 Blueberry
- 5745 Charteuse
- 5746 Mango
- 5747 Sedona
- 5748 Juniper
- 5749 Peanut

### Group 3

#### Billiard Multi-Use by Designtex

- 5H11 Poppy
- 5H12 Tangelo
- 5H13 Citrine/Citron
- 5H14 Avocado
- 5H16 Indigo
- 5H17 Mallard
- 5H18 Teak
- 5H19 Cumulus
- 5H20 Pewter
- 5H21 Gunmetal
- 5H22 Ink
- 5H23 Rose Quartz
- 5H24 Sea Salt
- 5H25 Storm Cloud
- 5H26 Olivine

### Group 5

#### Bo Peep

- 5G67 Bone
- 5G72 Honey Mustard
- 5G73 Marmalade
- 5G74 Picnic
- 5G75 Pinot
- 5G76 Bloom
- 5G77 Grapevine
- 5G79 Artichoke
- 5G80 Serpent
- 5G81 Carolina
- 5G82 Blue Bonnet
- 5G83 Nautical
- 5G84 Gravel
- 5G85 Sharkskin
- 5G86 Kohl

#### Remix

- RE01 Rust
- RE03 Pebble
- RE04 Dark Chocolate
- RE06 Linen Beige
- RE08 Concrete
- RE09 Sky Blue
- RE10 Blue Jean
- RE11 Ivy Green
- RE13 Night Blue

#### Silk

- 5L31 Dijon
- 5L32 Seaweed
- 5L33 Boysenberry
- 5L35 Marina
- 5L36 Heather Blue
- 5L37 Blue Raspberry
- 5L38 Cauldron
- 5L39 Flaxen

**E** = Excluded

# Customer's Own Material

## Customer's Own Material

Coalesse is pleased to cooperate with COM/COL selections. Prior to order placement for exact yardage requirements, a sample cutting of actual COM/COL must be submitted to Coalesse for approval only, if fabric approval is not found in Coalesse fabric database. Identify the name and number of units on which the fabric/leather is to be applied. If COM has a repeat, the sample should be large enough to show the entire repeat. Coalesse will not accept nor use any painted leathers. A painted leather is described as any suede or leather which is not aniline dyed with the same color throughout the thickness of the hide.

Even after preliminary approval, Coalesse reserves the right to reject COM/COL if necessary when the quality is not satisfactory for the item it is intended to be used on. Once COM/COL is accepted, Coalesse assumes no responsibility for its overall appearance, flammability, normal durability, colorfastness, or any other quality, after upholstered on a Coalesse product.

## Coalesse Standard to Buy Program

The Customer's Own Material (COM) Program offers the opportunity for customers to select fabrics that are not offered through the standard Coalesse surface materials program for use on our products. Through the COM program, Coalesse will test your materials for application on Coalesse products. Once approved, you can place your order. Coalesse will facilitate the entire ordering process and give you a production schedule. Coalesse will order the COM fabric directly from the textile manufacturer. For up-to-date information regarding fabric test results for all COM fabrics and details regarding yardage requirements for most Seating lines, visit the fabric database at [www.coalesse.com](http://www.coalesse.com).

## Customers to Buy Scheduling Policy/COM/COL Policy

COM/COL must be received at manufacturing location no later than 20 working days prior to the order scheduled delivery date. If COM/COL is not received in this time frame, scheduling will move the order's delivery date out to the best available ship date. Customer Service will notify the dealer via e-mail of the order's new scheduled delivery date. Project size order shipment may be affected due to size of order. If the COM/COL is received and the COM/COL requires backing, scheduling will move order out to best available ship date. Backing charges will apply. If COM/COL is received defective or short yardage/sq. ft., the replacement COM/COL order must be received within three days to maintain scheduled delivery date on order. It is the responsibility of the dealer to advise Coalesse on what to do with defective materials. In addition, customers may request Coalesse to order for COM/COL materials.

## Square Footage/Yardage Requirements

COM and COL price includes application of Customer's Own Material or Leather to frames. All COM and COL should be shipped freight prepaid to designated manufacturing location. Labels will be provided by your Customer Service representative to ensure clear textile identification.

Please have customers send COM/COL and add TAG: COM/COL.

COM and COL must be identified as follows to prevent order delays:

1. Name and address (should match purchase order)
2. Your furniture purchase order number/sales order
3. Style number to which fabric is to be applied
4. Supplier name and fabric name, number, and color

COL hides must be rolled for shipment to manufacturing location in a neat manner, avoiding creases and excessive roll marks. All leathers will be rejected if sent in a folded manner.

To determine COL square footage, see COL requirements for each product. Square footage requirements are based on an average hide size of 45-50 square feet of clean, usable leather. If the COL has a smaller average hide size, please consult Customer Service for quotation. Please note, leather is a natural product and all square footage requirements are estimations. The shape of the COL hides supplied and the usable, clean square footage may make it necessary for us to request more leather after COL is received.

Yardage requirements shown are based on 54" width plain material. If fabric design requires vertical/top out, Customer Service should be consulted for additional yards required. If fabric is under 54"W, refer to fabric database at [www.coalesse.com](http://www.coalesse.com).

## Excess COM/COL Policy

All excess COM/COL will be disposed of after order is completed unless prior arrangements have been made with Coalesse Customer Service. Fedex account number and address to ship to must be referenced. Excess WILL NOT be returned with shipment of furniture.

# Customer's Own Material

## Cutting Direction Guidelines

Cutting direction is based on the fabric width and the way the fabric is cut from the roll and applied to Coalesse products. There are two cutting directions: railroaded or horizontal.

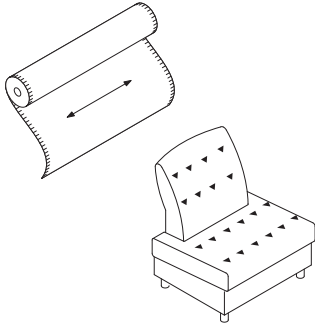

*Tip: Arrows on the above drawings indicate fabric direction.*

Horizontal or railroaded (across roll, warp horizontal) means fabric is cut across the roll; selvages are on the top and bottom.

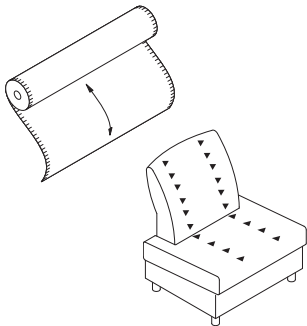

*Tip: Arrows on the above drawings indicate fabric direction.*

Vertical or top out (down roll, warp vertical) means fabric is cut in the same direction it is woven; selvages are on the left and right sides.

# Fabric Matrix Steelcase Standard Fabrics

*Note: Coalesse reserves the right to reject fabrics when necessary if the quality or construction is not satisfactory for intended use. For most up to date information on fabric usage please check the fabric database on [www.coalesse.com](http://www.coalesse.com).*

**Legend**

- = Not available
- = Available
- ▶ See specification pages in the *Coalesse Specification Guides* for details.

	Steelcase Fabrics											
	Jacks Group 1 E	Link Group 1	Cogent: Connect Group 2	Dovetail by DesignTex Group 2	Foundation Group 2	New Black Group 2	SoftNext Group 2	Stand In Group 2	Billiard Multi-Use by DesignTex Group 3	Bo Peep Group 5	Remix Group 5	Silk Group 5
Await	■	■	•	■	■	■	■	■	■	■	■	■
Bindu	■	■	■	■	■	■	■	■	■	■	■	■
Bob	■	■	■	■	■	■	■	■	■	■	■	■
Capa	■	■	■	■	■	■	■	■	■	■	■	■
Chord	■	■	■	■	■	■	■	■	■	■	■	■
Circa	■	■	•	■	■	■	■	■	■	■	■	■
Coalesse Ensemble Lounge	■	■	■	■	•	■	■	•	■	■	■	■
Coalesse Ensemble Screens	•	•	•	■	•	•	■	•	■	•	•	•
Coupe	■	■	■	■	■	■	■	■	■	■	■	■
Davos	■	■	■	■	■	■	■	■	■	■	■	■
Enea	■	■	■	■	■	■	■	■	■	■	■	■
Enea Lottus	■	■	■	■	■	■	■	■	■	■	■	■
Enea Altzo943	■	■	■	■	■	■	■	■	■	■	■	■
Exponents, Benches	■	■	■	■	■	■	■	■	■	■	■	■
Hosu	■	■	■	■	•	■	■	•	■	■	■	■
Joel	■	■	■	■	■	■	■	■	■	■	■	■
Kathryn	■	■	■	■	■	■	■	■	■	■	■	■
Lagunitas Cushion	■	■	■	■	■	■	■	■	■	■	■	■
Lox	■	■	•	■	■	■	■	■	■	■	■	■
Marien152	■	■	■	■	■	■	■	•	■	■	■	■
Massaud Lounge	■	■	■	■	■	■	■	■	■	■	■	■
Massaud Conference	■	■	■	■	■	■	■	■	■	■	■	■
Millbrae Contract	■	■	■	■	■	■	■	■	■	■	■	■
Millbrae Lifestyle	■	■	•	■	■	■	■	■	■	■	■	■
Montara650	■	■	■	■	■	■	■	■	■	■	■	■
Passerelle	■	■	■	■	■	■	■	■	■	■	■	■
Ripple	■	■	•	■	■	■	■	■	■	■	■	■
Sidewalk	■	■	■	■	■	■	■	■	■	■	■	■
Sistema Lounge System	■	■	•	■	■	■	■	■	■	■	■	■
SW_1	■	■	■	■	■	■	■	•	■	■	■	•
Switch	■	■	■	■	■	■	■	■	■	■	■	■
Thoughtful	■	■	■	■	■	■	■	■	■	■	■	■
Together	■	■	■	■	■	■	■	■	■	■	■	■
Visalia	■	■	■	■	■	■	■	■	■	■	■	■
Wrapp	■	■	•	■	■	■	■	■	■	■	■	■

■ = Excluded

*The above Steelcase fabrics are available as standard without a backer on select Coalesse product lines. For those product lines that are noted as unavailable, it may be specifiable with a backer as a Select Surface fabric. Additional Steelcase fabrics are available through the Select Surface program. Please consult the Coalesse Fabric Database for availability.*

Disclaimer: Coalesse is pleased to provide this information. However, even after preliminary approval, Coalesse reserves the right to reject fabrics/leathers when necessary if the quality or construction is not satisfactory for the item it is intended for use on. Coalesse reserves the right to evaluate data daily and make any necessary changes or improvements to the information provided. Textile recommendations do not imply a warranty for the textiles. The textile manufacturer provides all warranties for textiles. All trademarks and trade names are the property of the different manufacturers. All pricing quotes for product should be obtained from your local Sales Representative or a Coalesse Customer Service Representative. Recommendations such as backing and CAL 133 will require additional cost and may require additional lead-time. All specifications are subject to change without notice.

# Upholstery Palette Coalesse Knit

*Note: Coalesse reserves the right to reject fabrics when necessary if the quality or construction is not satisfactory for intended use. For most up to date information on fabric usage please check the fabric database on [www.coalesse.com](http://www.coalesse.com).*

## Group 1

SW\_1



Sand  
5KG0

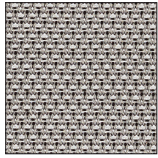

Silver  
5KG1



Black  
5KG3



Ivory  
5KG4



Coal  
5KG5

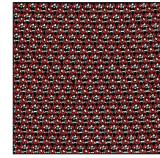

Fire  
5KG6

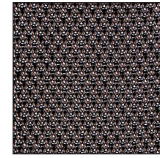

Pewter  
5KG9



Ice  
5KH0

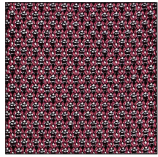

Currant  
5KH1

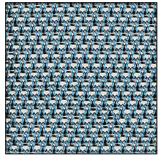

Ocean  
5KH2

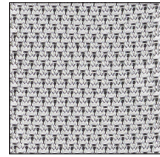

Silver Grey  
5KH3

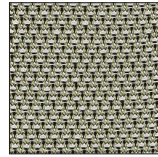

Olive  
5KH4

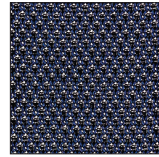

Blue Ink  
5KH5

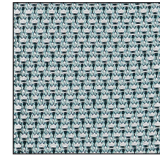

Blue Bird  
5KH6

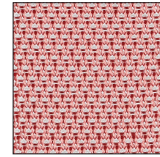

Blush  
5KH7



Goldenrod  
5KH8

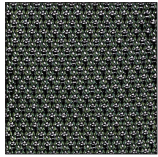

Leaf  
5KH9

## Lagunitas Focus Nook and Lounge System

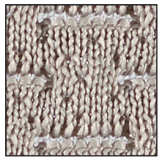

Sand  
5K50

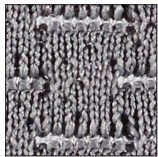

Silver  
5K51

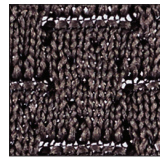

Pewter  
5K52

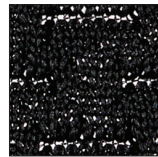

Black  
5K54

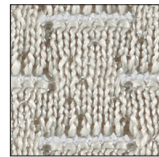

Ivory  
5K58

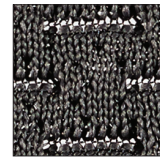

Coal  
5K59

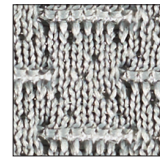

Silver Grey  
5K70

# Upholstery Palette Coalesse Knit *continued*

*Note: Coalesse reserves the right to reject fabrics when necessary if the quality or construction is not satisfactory for intended use. For most up to date information on fabric usage please check the fabric database on [www.coalesse.com](http://www.coalesse.com).*

---

## Group 2

---

### Lagunitas Focus Nook and Lounge System

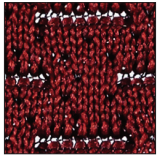

Fire  
5K55

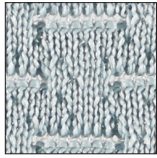

Ice  
5K60

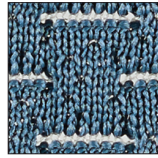

Ocean  
5K61

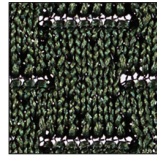

Leaf  
5K63

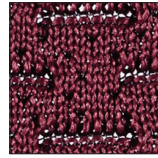

Currant  
5K67

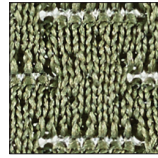

Olive  
5K71

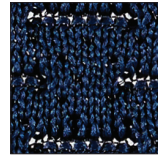

Blue Ink  
5K72

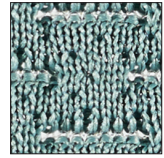

Blue Bird  
5K73

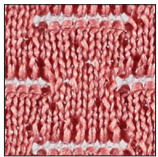

Blush  
5K74

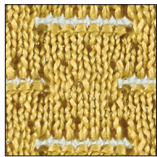

Goldenrod  
5K75

# Upholstery Palette Coalesse Fabric

*Note: Coalesse reserves the right to reject fabrics when necessary if the quality or construction is not satisfactory for intended use. For most up to date information on fabric usage please check the fabric database on [www.coalesse.com](http://www.coalesse.com).*

## Group 4

Hexa – For use on Hosu products only

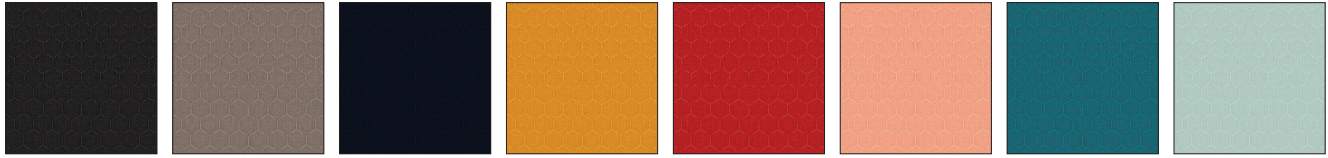

Dark Grey  
CL50

Light Grey  
CL51

Blue  
CL52

Yellow  
CL55

Saffron  
CL70

Rose Quartz  
CL71

Lagoon  
CL72

Sea Salt  
CL73

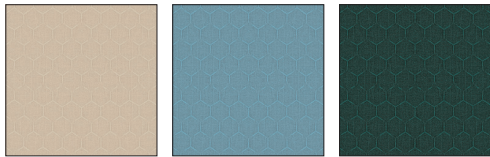

Steam  
CL74

Ocean  
CL75

Sage  
CL76

## Group 5

Fusion – For use on Massaud work lounge

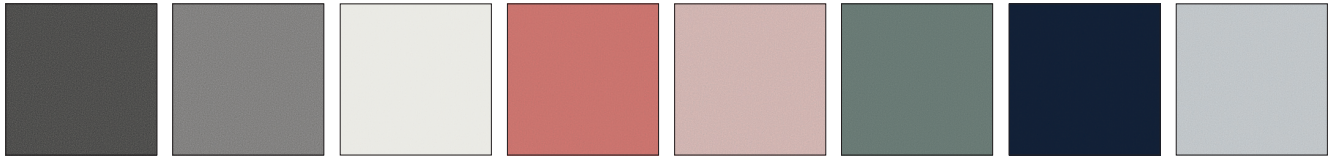

Caviar  
CL60

Graphite  
CL62

Steam\*  
CL64

Terracotta  
CL80

Copper  
CL81

Sage  
CL82

Blue Ink  
CL83

Blue Steel  
CL84

# Upholstery Palette Steelcase Fabric

---

## Group 1

---

### Jacks E

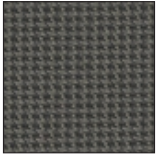

Taupe  
5B61



Camel  
5B63



Pewter  
5B64



Midnight  
5B70

---

### Link

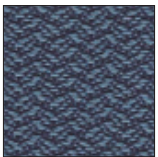

Blue  
5A24



Navy  
5A25

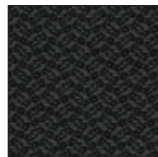

Black  
5A27

E = Excluded

# Upholstery Palette Steelcase Fabric

## Group 2

### Cogent: Connect



### Dovetail by Designtex



# Upholstery Palette Steelcase Fabric *continued*

---

## Group 2

---

### Foundation

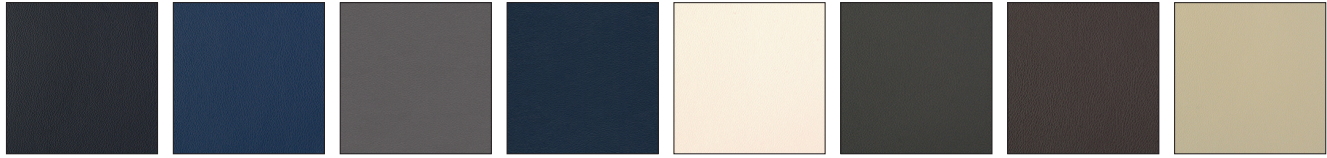

Black 5875	Navy 5876	Foggy Night 5877	Sailor 5878	Ivory 5879	Seal 5880	Peat 5881	New Sand 5882
---------------	--------------	---------------------	----------------	---------------	--------------	--------------	------------------

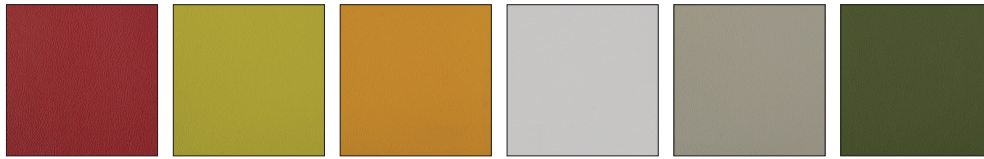

Cranberry 5883	Spring 5884	Honey 5885	Folkstone 5886	Pebble 5887	Oregano 5888
-------------------	----------------	---------------	-------------------	----------------	-----------------

---

### New Black



Jack 5J08	James 5J09	Harley 5J12
--------------	---------------	----------------

# Upholstery Palette Steelcase Fabric

## Group 2

### SoftNext



### Stand In

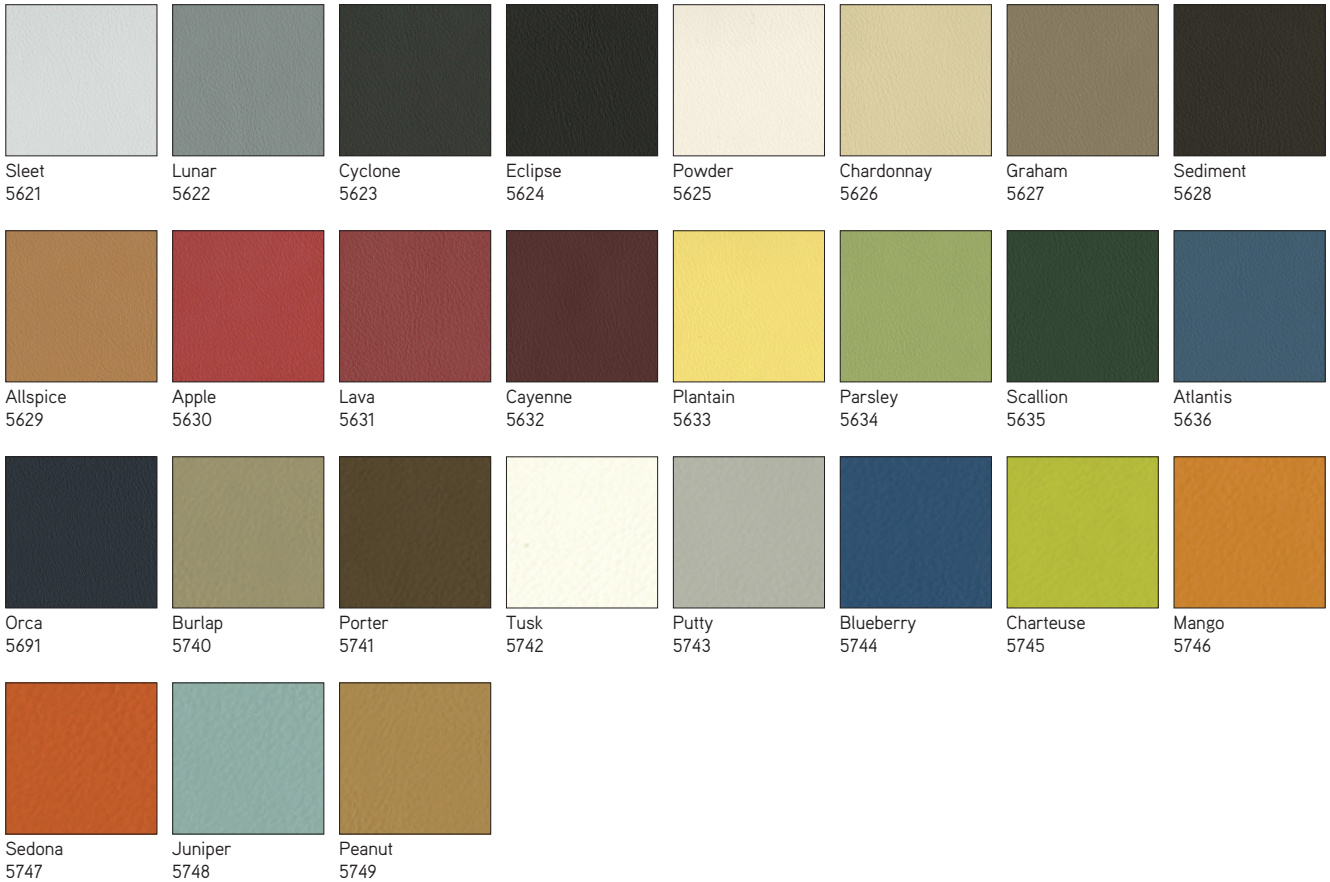

# Upholstery Palette Steelcase Fabric *continued*

---

## Group 3

### Billiard Multi-Use by Designtex

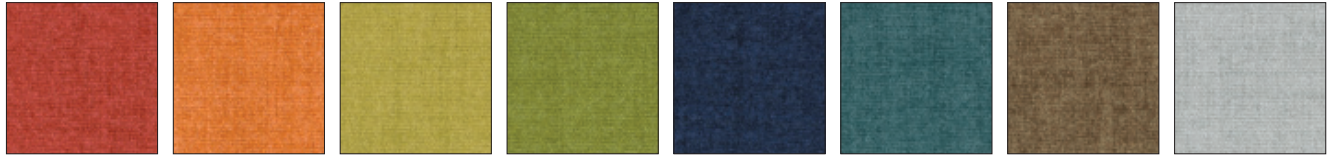

Poppy 5H11    Tangelo 5H12    Citrine/Citron 5H13    Avocado 5H14    Indigo 5H16    Mallard 5H17    Teak 5H18    Cumulus 5H19

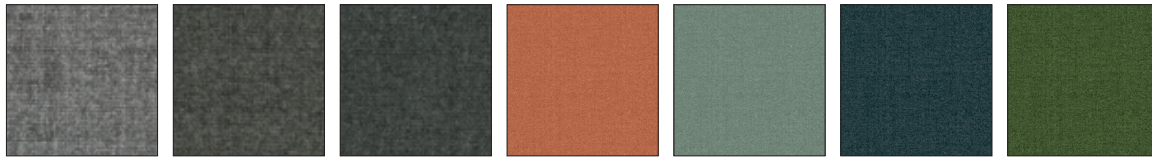

Pewter 5H20    Gunmetal 5H21    Ink 5H22    Rose Quartz 5H23    Sea Salt 5H24    Storm Cloud 5H25    Olivine 5H26

---

## Group 5

### Bo Peep

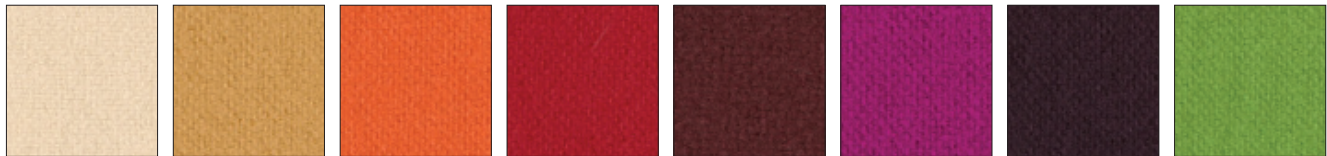

Bone 5G67    Honey Mustard 5G72    Marmalade 5G73    Picnic 5G74    Pinot 5G75    Bloom 5G76    Grapevine 5G77    Artichoke 5G79

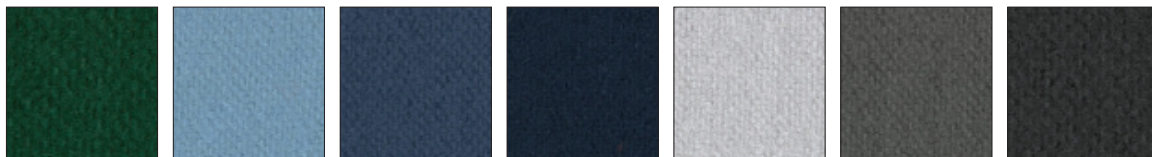

Serpent 5G80    Carolina 5G81    Blue Bonnet 5G82    Nautical 5G83    Gravel 5G84    Sharkskin 5G85    Kohl 5G86

# Upholstery Palette Steelcase Fabric

## Group 5

### Remix



Rust  
RE01



Pebble  
RE03

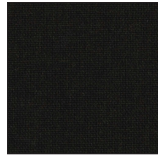

Dark Chocolate  
RE04



Linen Beige  
RE06

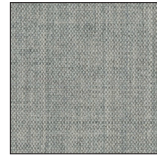

Concrete  
RE08



Sky Blue  
RE09

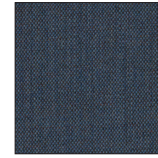

Blue Jean  
RE10

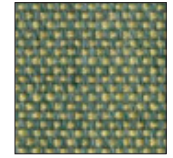

Ivy Green  
RE11



Night Blue  
RE13

### Silk

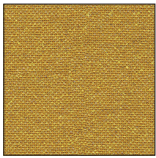

Dijon  
5L31

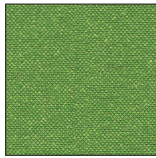

Seaweed  
5L32

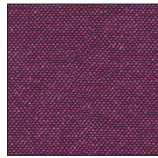

Boysenberry  
5L33

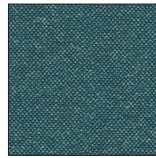

Marina  
5L35

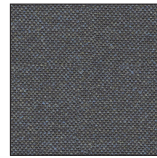

Heather Blue  
5L36

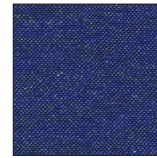

Blue Raspberry  
5L37

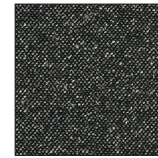

Cauldron  
5L38

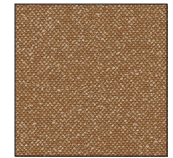

Flaxen  
5L39

# Leather/Faux

## Leather

### Elmosoft and Elmorustical Leather Care

Only the finest hides are used for Elmo leather. Expect some color variations from hide to hide due to the aniline state of the product. Color fading may occur if leather is exposed to direct or intense light. Care is required to allow this product to achieve the rich natural patina that beautiful natural leather develops. The hallmarks of this leather include some naturally occurring markings, such as healed scars, insect bites, stretch marks, and fat wrinkles. Elmorustical's leather treatment is very natural with little protection from spills or body oils. This rich leather will exhibit stains and oils through normal use. Coalesse is not responsible for discoloration, spotting, or staining on this leather.

### Special Color Match Leather

Coalesse can provide a special color match in its leather to any supplier's leather color, paint color, carpet color, wall-paper color, etc. Sample to match must be submitted to Coalesse with purchase order. Sample for approval can be supplied if requested.

*Note: Minimum order 2,500 sq. ft.*

### Special Fabric Applications\*

#### Backing\*

• Backing information is found on each product page in the Coalesse Specification Guides. Select this option when ordering your product to have backing applied. Price varies by product according to yardage it requires.

\*Prices subject to change without notice and an additional two week lead time will apply for 54" wide fabrics. Wider fabrics will require four weeks additional lead time.

## Elmo Leather

Coalesse uses leathers that are provided by Elmo of Sweden. Elmosoft is a full grain, aniline dyed, semi-aniline finish. With Elmosoft leather, now recyclable and chromium-free, you have the opportunity to bid on green projects when requested. Elmosoft leathers are never corrected, buffed, or altered in any way. Coalesse purchases only original full grain leathers. The quality of this genuine leather can be felt in the hand immediately. Other leathers are often stiff because of the amount of pigment needed to cover the imperfections of an inferior hide. Using leather of a low quality affects the overall quality of the furniture it is upholstered on. You can feel confident in leather purchased from Coalesse.

## Elmosoft

### Group 2

- L110 Maritime Blue
- L111 Midnight Blue
- L112 Ebony
- L113 Gunmetal
- L114 Mica
- L115 Dove Grey
- L116 Plum Pleasure
- L122 Truffle
- L128 Red Birch
- L133 Espresso
- L134 Ruby
- L139 Cinder
- L140 Garnet
- L143 Pecan
- L144 Chamois
- L146 Russet
- L147 Saddle
- L151 White
- L709 Sugar
- L711 Parchment
- L717 Cameo
- L723 Storm
- L730 Hunter
- L743 Forest Green
- L747 Cigar
- L749 Beaver
- L750 Bluffstone
- L755 Peanut Butter
- L758 Mustard
- L762 Canvas
- L763 Macadamia
- L770 Cadet
- L772 Timberwolf
- L773 Chalice
- L774 Oil
- L775 Coyote

## Elmorustical and Elmotique Leather

Elmorustical and Elmotique are a full-top grain, aniline dyed leather.

Elmorustical has a grain which varies in structure and offers outstanding comfort. It is an aniline leather with all the distinct features of the natural hide.

Elmotique is a thinner aniline leather with a batique-effect and displays all the features possessed by the original hide.

Only the finest hides are used for Elmorustical and Elmotique leathers. Expect some color variations from hide to hide due to the aniline state of the product. Color fading may occur if leather is exposed to direct or intense light. Care is required to allow this product to achieve the rich natural patina that beautiful leather develops. The hallmarks of this leather include some naturally occurring markings such as healed scars, insect bites, stretch marks, and fat wrinkles. Elmorustical and Elmotique's leather treatment is very natural with little protection from spills or body oils. This rich leather will exhibit stains and oils through normal use. Coalesse is not responsible for discoloration, spotting, or staining on this leather.

## Group 2

### Elmorustical

- L318 Loam
- L319 Ebony
- L321 Beige
- L323 Buff
- L325 Camel
- L326 Charbrown
- L330 Flame
- L332 Honey
- L334 Mist Green
- L337 Russet
- L338 Rust
- L363 Tendril
- L364 Fog
- L365 Sunflower
- L366 Terra Cotta
- L367 Cadet
- L368 Marine
- L369 Mallard
- L370 Smoke
- L371 Merlot
- LD54 Twilight

### Elmotique

- L311 Flaxen
- L312 Earth
- L313 Clay
- L314 Blue Mountain
- L315 Juniper

## Faux Leather

Coalesse offers a variety of faux leathers. Not all faux leathers are available on all products, check seating matrix on 21 to determine availability.

## Group 5

### Destiny

- DY01 Black
- DY02 Raisin
- DY03 Blueberry
- DY04 Chestnut
- DY05 Cedar
- DY06 Black Rose
- DY07 Wine
- DY08 Patine
- DY09 Dune
- DY10 Truffle
- DY11 Oak
- DY12 Newport
- DY13 Evergreen
- DY14 Storm
- DY15 Juniper
- DY16 Olive
- DY17 Mocha
- DY18 Ash
- DY21 Butter
- DY23 Deep Red
- DY24 Eggshell
- DY26 Parchment
- DY27 Periwinkle
- DY30 Royal Purple
- DY31 Saddle
- DY32 Cactus Green
- DY33 Cypress
- DY34 Mink
- DY35 Football
- DY36 Root

# Leather/Faux

**Finesse**

- : AM00 White Cloud
- : AM01 Gelato
- : AM02 Winter White
- : AM04 Mushroom
- : AM06 Charbrown
- : AM08 Iceberg
- : AM09 Gravel
- : AM10 Colonial Blue
- : AM25 Barley
- : AM26 Stucco
- : AM27 Beaver
- : AM28 Otter
- : AM65 Bordeaux
- : AM66 Navy
- : AM67 Cinder
- : AM80 Cameo
- : AM81 Oyster Grey
- : AM83 Taupe
- : AM85 Chestnut
- : AM87 Indigo
- : AM88 Bone
- : AM89 Jet Black
- : AM92 Burgundy
- : AM93 Hunter Green
- : AM98 Oxford Brown

**Ovation**

- : O500 Dark Brown
- : O501 Light Grey
- : O502 Sage
- : O503 Indigo
- : O504 Lilac
- : O505 Terra
- : O506 Moss
- : O507 Teal
- : O508 Stone
- : O509 Cappuccino

**Panache**

- : P800 Ebony
- : P801 Cactus
- : P802 Sherwood
- : P803 Teal Blue
- : P804 Sweet Sage
- : P805 Coffee
- : P806 True Taupe
- : P807 Cashew
- : P808 Acorn
- : P809 Redwood
- : P810 Exotic Orchid
- : P811 Maize
- : P812 Chartreuse
- : P813 Regal Blue

**Prestige**

- : AFA1 Onyx
- : AFB2 Soft White
- : AFC3 Saxe Blue
- : AFD3 Buff
- : AFDG Antique White
- : AFE1 Sandstone
- : AFH1 Pecan
- : AFH2 Buttercream
- : AF11 Havana
- : AF12 Brick
- : AFL8 French Grey
- : AFP1 Willow
- : AFP2 Boxwood Green
- : AFPA Tree Moss
- : AFPC Celadon
- : AFS3 Wild Plum

**Group 6**

**Brisa**

- : BR01 Black Onyx
- : BR04 Truffle
- : BR06 Ash
- : BR07 Sage
- : BR08 Celery
- : BR09 Sterling Blue
- : BR10 Night Navy
- : BR11 Cambridge Blue
- : BR12 Abyss
- : BR14 Pompeia
- : BR16 Cinnabar
- : BR18 New Sand
- : BR20 White
- : BR21 Moccasin
- : BR22 Buckskin
- : BR24 Mineral
- : BR25 Skyway
- : BR26 Iron
- : BR27 Stormy
- : BR28 Esmeralda
- : BR29 Seaweed
- : BR30 Bone
- : BR31 Caramel
- : BR32 Bridle
- : BR33 Moon

**Destiny Perforated**

- : DP01 Black
- : DP02 Raisin
- : DP03 Blueberry
- : DP04 Chestnut
- : DP05 Cedar
- : DP06 Black Rose
- : DP07 Wine
- : DP08 Patine
- : DP09 Dune
- : DP10 Truffle
- : DP11 Oak
- : DP12 Newport
- : DP13 Evergreen
- : DP14 Storm
- : DP15 Juniper
- : DP16 Olive
- : DP17 Mocha
- : DP21 Butter
- : DP23 Deep Red
- : DP24 Eggshell
- : DP26 Parchment
- : DP27 Periwinkle
- : DP30 Royal Purple
- : DP31 Saddle
- : DP32 Cactus Green
- : DP33 Cypress
- : DP34 Mink
- : DP35 Football
- : DP36 Root

**Elegance**

- : EL01 Ivory
- : EL02 Cream
- : EL03 Char
- : EL04 Saddle
- : EL05 Dune
- : EL06 Camel
- : EL07 Sage
- : EL08 Gray
- : EL09 Walnut
- : EL10 Burgundy
- : EL11 Green
- : EL12 Navy
- : EL13 Black

**Finesse Perforated**

- : AP00 White Cloud
- : AP01 Gelato
- : AP02 Winter White
- : AP04 Mushroom
- : AP06 Charbrown
- : AP08 Iceberg
- : AP09 Gravel
- : AP10 Colonial Blue
- : AP25 Barley
- : AP26 Stucco
- : AP27 Beaver
- : AP28 Otter
- : AP65 Bordeaux
- : AP66 Navy
- : AP67 Cinder
- : AP80 Cameo
- : AP81 Oyster Grey
- : AP83 Taupe
- : AP85 Chestnut
- : AP87 Indigo
- : AP88 Bone
- : AP89 Jet Black
- : AP92 Burgundy
- : AP93 Hunter Green
- : AP98 Oxford Brown

**Panache Perforated**

- : PR00 Ebony
- : PR01 Cactus
- : PR02 Sherwood
- : PR03 Teal Blue
- : PR04 Sweet Sage
- : PR05 Coffee
- : PR06 True Taupe
- : PR07 Cashew
- : PR08 Acorn
- : PR09 Redwood
- : PR10 Exotic Orchid
- : PR11 Maize
- : PR12 Chartreuse
- : PR13 Regal Blue

**Prestige Perforated**

- : APA1 Onyx
- : APB2 Soft White
- : APC3 Saxe Blue
- : APD3 Buff
- : APDG Antique White
- : APE1 Sandstone
- : APH1 Pecan
- : APH2 Buttercream
- : API1 Havana
- : API2 Brick
- : APL8 French Grey
- : APP1 Willow
- : APP2 Boxwood Green
- : APPA Tree Moss
- : APPC Celadon
- : APS3 Wild Plum

Leather/Faux

# Cut Yardage Net Price List

FABRIC NAME	Under 60 Yards	60 Yards & Over	
<b>Elegance®</b>	\$133.00/yd.	\$122.00/yd.	
<b>Finesse®</b>	\$80.00/yd.	\$79.00/yd.	
<b>Finesse® Perforated</b> (min. 5 yds)	\$96.00/yd.	\$95.00/yd.	
<b>Prestige®</b>	\$87.00/yd.	\$82.00/yd.	
<b>Prestige® Perforated</b> (min. 5 yds)	\$104.00/yd.	\$100.00/yd.	
<b>Destiny®</b>	\$88.00/yd.	\$84.00/yd.	
<b>Destiny® Perforated</b> (min. 5 yds)	\$106.00/yd.	\$101.00/yd.	
<b>Ovation</b>	\$88.00/yd.	\$82.00/yd.	
<b>Panache</b>	\$88.00/yd.	\$84.00/yd.	

LEATHER NAME	Under 500 sq. ft.	500-1000 sq. ft.	Over 1000 sq.ft.
<b>Elmosoft</b>	\$11.00/sq. ft.	\$9.00/sq. ft.	\$9.00/sq. ft.
<b>Elmorustical*</b>	\$17.00/sq. ft.	\$11.00/sq. ft.	\$10.00/sq. ft.

\*See page 18 for Elmorustical Leather care.

## ORDERING INFORMATION

- Minimum Order Requirements
  - Fabric: 1 yd. - 1/8 yd. increments.
  - Leather: 1 full hide (avg. sq. ft./hide - 50).
  - All orders will be filled in full hides only.
  - Overage will be invoiced accordingly.
  - Cancelled textile orders are subject to a 30% restocking fee. Order must be cancelled 5 days before ship date.
  - Special match leather: 2,500 sq. ft. minimum (Check delivery date)
  - The embossing techniques used on Novasuede Perforated, to achieve these looks involve very high temperatures. Color and shade may vary slightly based on the fiber density being embossed.
- Due to the natural processes of dying, sanding and embossing necessary to achieve these special looks, actual production may vary slightly in appearance from the swatches shown.

## COALESSE TEXTILE WARRANTY

Coalesse textile merchandise is produced in accordance with Coalesse high standards. Coalesse does not guarantee, warrant or accept any responsibility whatsoever by reason of its fabrics or leathers fading, wearing, cracking, shrinking, stretching, tearing, seam slippage, alteration in color due to any finish treatment (flameproofing, stain repellent, etc.) or discoloration from liquid contact. Printed textiles are not warranted against irregularity in register. Coalesse is not responsible for dye lot differences or discrepancies in widths of fabrics. Coalesse does not guarantee, warrant or represent an exact color match to cuttings, tabs, memos or sample cards. Coalesse does not warrant exact matching of color or grain of leather. Leather hides may contain certain natural marks, scars, scratches, wrinkles and shade variations within hides, etc., considered by leather tanneries and Coalesse to be inherent characteristics part of the natural beauty of leather and the size or location of such markings cannot be controlled. In any event, upon inspection, Coalesse's responsibility shall be limited to either replacement of merchandise or refund of purchase price at Coalesse's option. The foregoing constitutes the sole and exclusive remedy of the customer. Coalesse is not responsible for the application or installation of our products. In no event shall Coalesse be responsible for any consequential damages or any charges, costs, expenses, or obligations other than as expressly herein set forth. Coalesse makes no other warranties, expressed or implied, as to any product sold by Coalesse. All other warranties (including any warranty of merchantability or fitness for any particular purpose) are hereby excluded.



**For Canadian Pricing**  
 Multiply U.S. Price by the  
 Canadian price factor.  
 ▶ See page 1 for details.

# Leather and Faux Leather Matrix

Note: Coalesse reserves the right to reject fabrics when necessary if the quality or construction is not satisfactory for intended use. For most up to date information on fabric usage please check the fabric database on [www.coalesse.com](http://www.coalesse.com).

Legend	Elmosoft Group 2	Elmorustical Group 2	Elmotique Group 2	Destiny Group 5	Finesse Group 5	Ovation Group 5	Panache Group 5	Prestige Group 5	Brisa Group 6	Destiny Perforated Group 6	Elegance Group 6	Finesse Perforated Group 6	Panache Perforated Group 6	Prestige Perforated Group 6
• = Not available														
■ = Available														
▣ = Available but will have comfort wrinkles														
▶ See specification pages in the Coalesse Specification Guides for details.														
Await	■	■	•	■	■	■	■	■	■	■	■	■	■	■
Bindu	■	■	•	■	■	■	■	■	■	■	■	■	■	■
Bob	■	■	•	■	■	■	■	■	■	•	■	•	■	•
Capa	■	■	•	■	■	■	■	■	■	■	■	■	■	■
Chord	■	■	•	■	■	■	■	■	■	■	■	■	■	■
Circa	■	■	•	■	■	■	■	■	■	■	■	■	■	■
Coupe	■	■	•	■	■	■	■	■	■	■	■	■	■	■
Davos	■	■	•	■	■	■	■	■	■	•	■	•	•	•
Enea	■	■	•	■	■	■	■	■	■	■	■	■	■	■
Enea Lottus	■	■	■	■	■	■	■	■	■	•	■	•	•	•
Enea Café Wood Stool	■	■	■	■	■	■	■	■	■	■	■	■	■	■
Enea Altzo943	■	■	■	■	■	■	■	■	■	•	■	•	•	•
Exponents (Benches)	■	■	•	■	■	■	■	■	■	•	■	•	•	•
Joel	■	■	•	■	■	■	■	■	■	•	■	•	•	•
Kathryn	■	■	■	■	■	■	■	■	■	■	■	■	■	■
Lagunitas	■	■	•	■	■	■	■	■	■	■	■	■	■	■
Lox	■	■	■	■	■	■	■	■	■	•	■	•	•	•
Marien152	■	■	•	■	■	■	■	■	■	•	■	•	■	•
Massaud	■	■	•	•	■	■	■	■	■	•	■	■	■	■
Millbrae Contract	■	■	•	■	■	■	■	■	■	■	■	■	■	■
Millbrae Lifestyle	■	■	■	■	■	■	■	■	■	■	■	■	■	■
Montara650	■	■	•	■	■	■	■	■	■	•	■	•	■	•
Passerelle	■	■	•	■	■	■	■	■	■	■	■	■	■	■
Potrero 415 Light*	■	•	•	•	•	•	•	•	•	•	•	•	•	•
Ripple	■	■	•	■	■	■	■	■	■	■	■	■	■	■
Sidewalk	■	■	•	■	■	■	■	■	■	■	■	■	■	■
Sistema Lounge System	■	•	•	■	■	■	■	■	■	•	■	•	•	•
SW_1	■	•	■	■	■	■	■	■	■	•	■	•	•	•
Switch	■	■	•	■	■	■	■	■	■	■	■	■	■	■
Thoughtful	■	■	•	■	■	■	■	■	■	■	■	■	■	■
Together	▣	▣	•	▣	▣	■	▣	▣	▣	•	▣	•	•	•
Visalia	■	■	•	■	■	■	■	■	■	■	■	■	■	■
Wrapp	■	■	•	■	■	■	■	■	■	■	■	■	■	■

\*Curated palette of Elmosoft Leather is available.

Disclaimer: Coalesse is pleased to provide this information. However, even after preliminary approval, Coalesse reserves the right to reject fabrics/leathers when necessary if the quality or construction is not satisfactory for the item it is intended for use on. Coalesse reserves the right to evaluate data daily and make any necessary changes or improvements to the information provided. Textile recommendations do not imply a warranty for the textiles. The textile manufacturer provides all warranties for textiles. All trademarks and trade names are the property of the different manufacturers. All pricing quotes for product should be obtained from your local Sales Representative or a Coalesse Customer Service Representative. Recommendations such as backing and CAL 133 will require additional cost and may require additional lead-time. All specifications are subject to change without notice.

# Leather Palette

*Note: Coalesse reserves the right to reject fabrics when necessary if the quality or construction is not satisfactory for intended use. For most up to date information on fabric usage please check the fabric database on [www.coalesse.com](http://www.coalesse.com).*

▶ See *Leather and Faux Leather Matrix* for availability by product list, page 21.

## Group 2

### Elmosoft

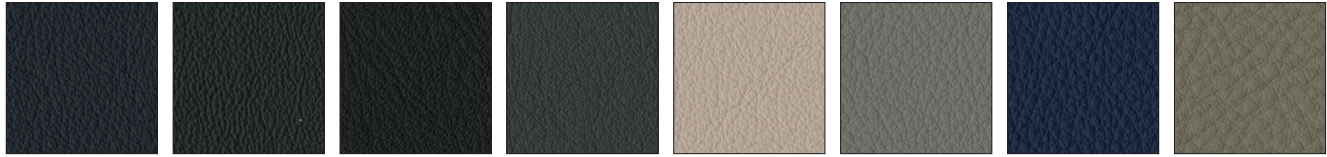

Maritime Blue L110    Midnight Blue L111    Ebony L112    Gunmetal L113    Mica L114    Dove Grey L115    Plum Pleasure L116    Truffle L122



Red Birch L128    Espresso L133    Ruby L134    Cinder L139    Garnet L140    Pecan L143    Chamois L144    Russet L146



Saddle L147    White L151    Sugar L709    Parchment L711    Cameo L717    Storm L723    Hunter L730    Forest Green L743

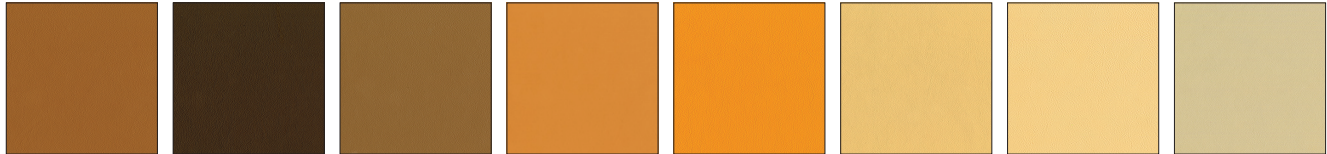

Cigar L747    Beaver L749    Bluffstone L750    Peanut Butter L755    Mustard L758    Canvas L762    Macadamia L763    Cadet L770

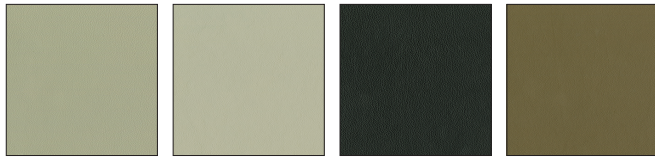

Timberwolf L772    Chalice L773    Oil L774    Coyote L775

# Leather Palette

*Note: Coalesse reserves the right to reject fabrics when necessary if the quality or construction is not satisfactory for intended use. For most up to date information on fabric usage please check the fabric database on [www.coalesse.com](http://www.coalesse.com).*

► See *Leather and Faux Leather Matrix* for availability by product list, page 21.

## Group 2

### Elmorustical

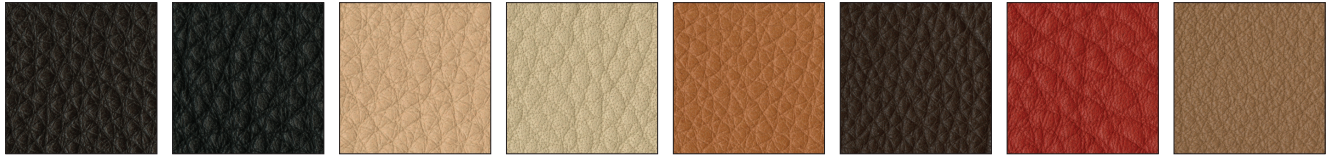

Loam L318    Ebony L319    Beige L321    Buff L323    Camel L325    Charbrown L326    Flame L330    Honey L332

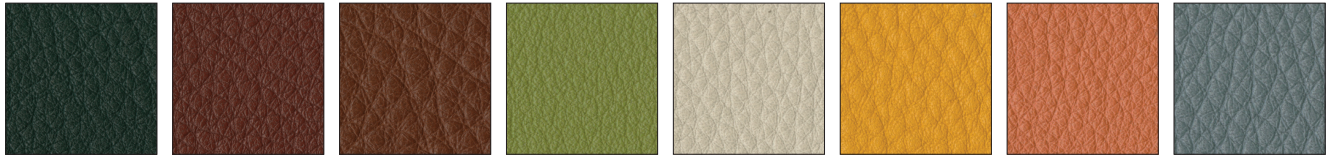

Mist Green L334    Russet L337    Rust L338    Tendril L363    Fog L364    Sunflower L365    Terra Cotta L366    Cadet L367



Marine L368    Mallard L369    Smoke L370    Merlot L371    Twilight LD54

### Elmotique



Flaxen L311    Earth L312    Clay L313    Blue Mountain L314    Juniper L315

# Faux Leather Palette

*Note: Coalesse reserves the right to reject fabrics when necessary if the quality or construction is not satisfactory for intended use. For most up to date information on fabric usage please check the fabric database on [www.coalesse.com](http://www.coalesse.com).*

► See *Leather and Faux Leather Matrix* for availability by product list, page 21.

## Group 5

### Destiny

							
Ash DY18	Black DY01	Black Rose DY06	Blueberry DY03	Butter DY21	Cactus Green DY32	Cedar DY05	Chestnut DY04
							
Cypress DY33	Deep Red DY23	Dune DY09	Eggshell DY24	Evergreen DY13	Football DY35	Juniper DY15	Mink DY34
							
Mocha DY17	Newport DY12	Oak DY11	Olive DY16	Parchment DY26	Patine DY08	Periwinkle DY27	Raisin DY02
							
Root DY36	Royal Purple DY30	Saddle DY31	Storm DY14	Truffle DY10	Wine DY07		

# Faux Leather Palette

*Note: Coalesse reserves the right to reject fabrics when necessary if the quality or construction is not satisfactory for intended use. For most up to date information on fabric usage please check the fabric database on [www.coalesse.com](http://www.coalesse.com).*

► See *Leather and Faux Leather Matrix* for availability by product list, page 21.

## Finesse



Leather/Faux

## Ovation



# Faux Leather Palette continued

*Note: Coalesse reserves the right to reject fabrics when necessary if the quality or construction is not satisfactory for intended use. For most up to date information on fabric usage please check the fabric database on [www.coalesse.com](http://www.coalesse.com).*

► See *Leather and Faux Leather Matrix* for availability by product list, page 21.

## Panache

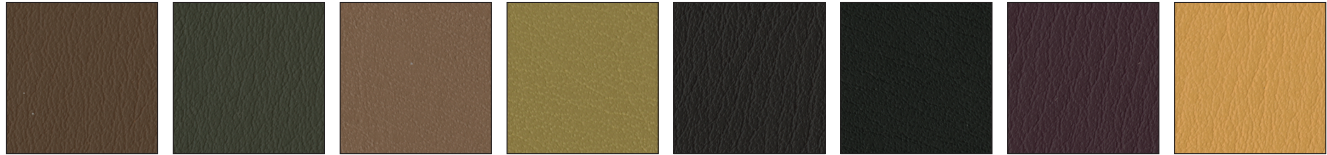

Acorn P808	Cactus P801	Cashew P807	Chartreuse P812	Coffee P805	Ebony P800	Exotic Orchid P810	Maize P811
---------------	----------------	----------------	--------------------	----------------	---------------	-----------------------	---------------



Redwood P809	Regal Blue P813	Sherwood P802	Sweet Sage P804	Teal Blue P803	True Taupe P806
-----------------	--------------------	------------------	--------------------	-------------------	--------------------

## Prestige

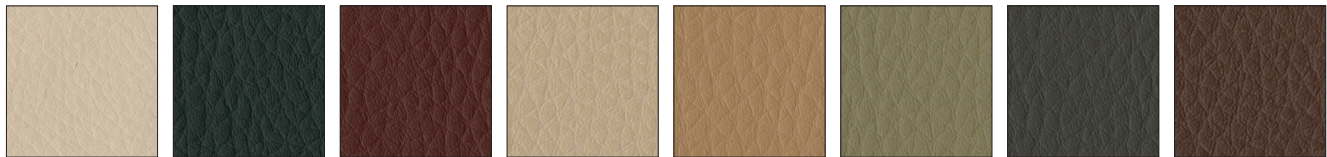

Antique White AFDG	Boxwood Green AFP2	Brick AFI2	Buff AFD3	Buttercreme AFH2	Celadon AFPC	French Grey AFL8	Havana AFI1
-----------------------	-----------------------	---------------	--------------	---------------------	-----------------	---------------------	----------------



Onyx AFA1	Pecan AFH1	Sandstone AFE1	Saxe Blue AFC3	Soft White AFB2	Tree Moss AFPA	Wild Plum AFS3	Willow AFP1
--------------	---------------	-------------------	-------------------	--------------------	-------------------	-------------------	----------------

# Faux Leather Palette

*Note: Coalesse reserves the right to reject fabrics when necessary if the quality or construction is not satisfactory for intended use. For most up to date information on fabric usage please check the fabric database on [www.coalesse.com](http://www.coalesse.com).*

► See *Leather and Faux Leather Matrix* for availability by product list, page 21.

## Group 6

### Brisa



Leather/Faux

### Elegance



# Wood

## Wood

### Standard Wood Finishes

Coalesse's primary wood finish, Clarity, is a water-borne UV topcoat, which protects the environment while providing exceptional durability and resistance to water and chemical stains. Contoured products, such as wood guest chairs and occasional tables, are finished with post-catalyzed vinyl, which provides similar properties and matches the sheen and color of Clarity. Due to natural variations in wood, finished products may vary from samples in color, texture, and grain.

Wood will develop a deep, rich patina over time as the wood ages. Mineral streaks, gum pockets, and pin knots are some of the unique characteristics that are visible in veneers and solids.

All wood products will darken with age and exposure to ultraviolet light. This is especially apparent with cherry and maple veneer.

When storing your wood furniture, please follow the following guidelines:

- Do not store products in trailers
- Store products in areas that simulate office temperatures (60°F to 90°F)
- Store products in areas that maintain constant, office-like humidity levels
- Keep product away from light. Cover products to make sure they are not exposed to light.

Samples contact Customer Service at 1.800.627.6770

### Steelcase Wood Finishes

Coalesse will match current Steelcase wood finishes at no upcharge. Finish matches are for color only and do not match the Steelcase finish in sheen.

Natural veneers celebrate the natural beauty of wood with neutral tones.

Plank veneers were intentionally designed to enhance the unique characteristics of wood with natural variations that include grain pattern, color, and texture that are meant to be celebrated.

### Steelcase Select Surfaces

In addition to the standard Steelcase veneer palette, Coalesse offers Steelcase Select Surfaces.

Composite veneers are engineered veneer intended to create consistent grain patterns and characteristics with minimal inconsistency within an order. Please note that because these finishes are part of Steelcase Select Surfaces, they may have additional lead times.

### Painted MDF

The painted medium density fiberboard (MDF) is utilizing molding grade MDF, therefore, the 45 lb density is consistent throughout the entire thickness of the board. This allows for a smooth edge when painted. Three coats of water reducible finish is applied to the board in a milk or black. The painted MDF has durability and care properties like a wood veneer, thus, must be treated as such.

### Wood Veneer Specifications

#### Cherry

- American Black Cherry
- Flat-cut, plain sliced/book matched
- Quarter-cut/book matched
- Narrow cathedrals, mild grain, minimal pitch
- 5-10" wide leaves of 1/42" thick veneer, balanced on panel
- No gaps between leaves
- PB (particle board) core
- Low sheen 15 or high sheen 35

#### Maple

- Eastern Hard White Maple
- Flat-cut, plain sliced/slip matched
- Quarter-cut/book matched
- Narrow cathedrals, mild grain, minimal pitch
- 5-10" wide leaves of 1/42" thick veneer, balanced on panel
- No gaps between leaves
- PB (particle board) core
- Low sheen 15 or high sheen 35

#### Oak

- White Oak
- Rift-cut
- Slip match
- Mild grain
- 4-8" wide leaves of 1/42" thick veneer, balanced on panel
- No gaps between leaves
- PB (particle board) core
- Low sheen 15 or high sheen 35

### Walnut

- American Black Walnut
- Flat-cut, plain sliced/book matched
- Quarter-cut/book matched
- Narrow cathedrals, mild grain
- 5-10" wide leaves of 1/42" thick veneer, balanced on panel
- No gaps between leaves
- PB (particle board) core
- Low sheen 15 or high sheen 35

Exclusive (by product)

#### Teak

- Quarter-cut/book match
- 15 sheen

#### Ash (Grey)

- Quarter-cut/book match
- 15 sheen

### Flat-Cut – High Sheen

#### Group 1

- V10C FC/HS Natural Cherry
- V11C FC/HS Clear Cherry
- V12C FC/HS Medium Amber Cherry
- V13C FC/HS Dark Cherry
- V10M FC/HS Clear Maple
- V11M FC/HS Natural Beech on Maple
- V12M FC/HS Medium Maple
- V10W FC/HS Natural Walnut
- V11W FC/HS Clear Walnut
- V12W FC/HS Medium Walnut
- V13W FC/HS Black Walnut
- V14W FC/HS Dark Walnut

### Flat-Cut – Low Sheen

#### Group 1

- V1AC FC/LS Natural Cherry
- V1BC FC/LS Clear Cherry
- V1CC FC/LS Medium Amber Cherry
- V1DC FC/LS Dark Cherry
- V1AM FC/LS Clear Maple
- V1BM FC/LS Natural Beech on Maple
- V1CM FC/LS Medium Maple
- V1AW FC/LS Natural Walnut
- V1BW FC/LS Clear Walnut
- V1CW FC/LS Medium Walnut
- V1EW FC/LS Dark Walnut

### Rift-Cut – High Sheen

#### Group 1

- V30K RC/HS Natural Oak
- V31K RC/HS Desert Oak
- V32K RC/HS Medium Brown Oak
- V33K RC/HS Medium Gray Oak
- V34K RC/HS Black Brown Oak

### Rift-Cut – Low Sheen

#### Group 1

- V3AK RC/LS Natural Oak
- V3BK RC/LS Desert Oak
- V3CK RC/LS Medium Brown Oak
- V3DK RC/LS Medium Gray Oak
- V3EK RC/LS Black Brown Oak

FC=Flat-Cut

RC=Rift-Cut

QC=Quarter-Cut

HS=High Sheen

LS=Low Sheen

# Wood

Applies to: Enea Altzo943, Montara650 Tables and Seating, and Sistema Lounge System

**Group 1**

- VP01 Light Oak
- VP03 Black Oak
- VP05 White Oak

**Group 2**

- VP02 Smoked Oak
- VP04 Grey Oak

**Quarter-Cut – High Sheen**

**Group 2**

- V20C QC/HS Natural Cherry
- V21C QC/HS Clear Cherry
- V22C QC/HS Medium Amber Cherry
- V23C QC/HS Dark Cherry
- V20M QC/HS Clear Maple
- V21M QC/HS Natural Beech on Maple
- V22M QC/HS Medium Maple
- V20W QC/HS Natural Walnut
- V21W QC/HS Clear Walnut
- V22W QC/HS Medium Walnut
- V23W QC/HS Black Walnut
- V24W QC/HS Dark Walnut

**Quarter-Cut – Low Sheen**

**Group 2**

- V2AA QC/LS Ash Natural FSC
- V2AC QC/LS Natural Cherry
- V2BC QC/LS Clear Cherry
- V2CC QC/LS Medium Amber Cherry
- V2DC QC/LS Dark Cherry
- V2AM QC/LS Clear Maple
- V2BM QC/LS Natural Beech on Maple
- V2CM QC/LS Medium Maple
- V2AW QC/LS Natural Walnut
- V2BW QC/LS Clear Walnut
- V2CW QC/LS Medium Walnut
- V2EW QC/LS Dark Walnut
- V2AT QC/LS Teak Natural Raw FSC

- FC = Flat-Cut
- RC = Rift-Cut
- QC = Quarter-Cut
- HS = High Sheen
- LS = Low Sheen
- OP = Open Pore
- Ⓔ = Excluded

**Steelcase Veneers, Open Pore Only**

**Group 1**

**Cherry, Flat-Cut**

- 3402 FC/OP Clear Cherry
- 3412 FC/OP Natural Cherry Ⓔ
- 3422 FC/OP Medium Cherry

**Maple, Flat-Cut**

- 3522 FC/OP Clear Maple
- 3592 FC/OP Blonde on Maple Ⓔ

**Maple, Quarter-Cut**

- 3222 QC/OP Clear Maple
- 3292 QC/OP Blonde on Maple Ⓔ

**Walnut, Flat-Cut**

- 3062 FC/OP Graphite Walnut
- 3342 FC/OP Black Walnut
- 3702 FC/OP Clear Walnut
- 3712 FC/OP Natural Walnut
- 3752 FC/OP Medium Walnut Ⓔ
- 3762 FC/OP Dark Walnut
- 3772 FC/OP Medium Mahogany on Walnut

**Walnut, Quarter-Cut**

- 3302 QC/OP Clear Walnut
- 3312 QC/OP Natural Walnut
- 3352 QC/OP Medium Walnut Ⓔ
- 3362 QC/OP Dark Walnut
- 3372 QC/OP Medium Mahogany on Walnut
- 3382 QC/OP Graphite Walnut
- 3392 QC/OP Black Walnut

**Oak, Rift-Cut**

- 3602 RC/OP Desert Oak

**Premium Wood, Quarter-Cut**

- 3832 QC/OP Figured Anegre

**Planked Veneer**

- 3P41 OP Planked Cherry
- 3P51 OP Planked Maple
- 3P61 OP Planked Oak
- 3P71 OP Planked Walnut
- 3VFX OP Unmarked Oak

**Natural Veneer, Flat-Cut**

- 35A2 FC/OP Blanch Maple
- 37A2 FC/OP Thunder Walnut

**Natural Veneer, Rift Cut**

- 36A2 RC/OP Volcanic Oak

**Group 2**

**Ash, Quarter-Cut**

- 3042 QC/OP Ash Ⓔ

**Natural Veneer, Flat-Cut**

- 3082 FC/OP Washed Walnut

**Natural Veneer, Quarter Cut**

- 32A2 QC/OP Blanch Maple
- 33A2 QC/OP Thunder Walnut

**Steelcase Select Surfaces Veneers, Open Pore Only**

**Group 1**

**Composite Veneer, Flat-Cut**

- 3JDX FC/OP Oak Composite
- 3JXX FC/OP Walnut Composite
- 3LAX FC/OP Graphite on Oak Composite
- 3LCX FC/OP Medium Cherry on Cherry Composite

**Group 2**

**Composite Veneer, Flat-Cut**

- 3LHX FC/OP Espresso on Walnut Composite

**Composite Veneer, Quarter-Cut**

- 3F8X QC/OP European Walnut Composite
- 3GGX QC/OP Zebrano Composite
- 3HGX QC/OP Oak Composite
- 3HVX QC/OP Walnut Composite
- 3LBX QC/OP Clear Walnut on Walnut Composite
- 3LDX QC/OP Natural Walnut on Walnut Composite
- 3LEX QC/OP Desert Oak on Oak Composite
- 3LGX QC/OP Chai on Walnut Composite
- 3LJX QC/OP Ebony on Walnut Composite
- 3ZNX QC/OP Dark Cerused Oak Composite

**Painted MDF**

Applies to: Exponents Whiteboard and Mobile Display

- V145 Milk
- V197 Black

# Solid Wood Matrix

For Solid Hardwood Components of Seating and Tables

**Legend**

- = Not available
- = Available
- = Stain color only on maple
- = Stain color on Beech
- ▶ See specification pages in the Coalesse Specification Guides for details.

	Maple Flat-Cut – High Sheen	Maple Flat-Cut – Low Sheen	Maple Quarter-Cut – High Sheen	Maple Quarter-Cut – Low Sheen	Cherry Flat-Cut – High Sheen	Cherry Flat-Cut – Low Sheen	Cherry Quarter-Cut – High Sheen	Cherry Quarter-Cut – Low Sheen	Oak Rift-Cut – High Sheen	Oak Rift-Cut – Low Sheen	Walnut Flat-Cut – High Sheen	Walnut Flat-Cut – Low Sheen	Walnut Quarter-Cut – High Sheen	Walnut Quarter-Cut – Low Sheen	Teak Quarter-Cut – High Sheen	Teak Quarter-Cut – Low Sheen	Grey Ash – High Sheen	Grey Ash – Low Sheen
<b>Seating</b>																		
Circa Cylinder Legs	•	•	•	•	•	•	•	•	■	■	•	•	•	•	•	•	•	•
Circa Tapered Legs	•	•	■	■	•	•	•	•	•	•	•	•	■	■	•	•	•	•
Coalesse Ensemble Feet	•	•	•	•	•	•	•	•	■	■	•	•	•	•	•	•	•	•
Coupe Lounge	■	■	•	•	■	■	•	•	■	■	■	■	•	•	•	•	•	•
Enea Altzo943	•	•	•	•	•	•	•	•	•	■	•	•	•	•	•	•	•	•
Enea Café Wood Stool*	•	•	•	•	•	•	•	•	•	■	•	•	•	•	•	•	•	•
Kathryn	■	■	•	•	■	■	•	•	■	■	■	■	•	•	•	•	•	•
Marien152	•	•	•	•	•	•	•	•	■	■	•	•	•	•	•	•	•	•
Passerelle	■	■	•	•	■	■	•	•	■	■	■	■	•	•	•	•	•	•
Sistema Lounge System**	•	•	•	•	•	•	•	•	•	■	•	•	•	•	•	•	•	•
Thoughtful	■	■	•	•	•	•	•	•	•	■	■	•	•	•	•	•	•	•

\* V3AK Natural Oak only.

\*\* Select colors only: VP01, VP02, VP03, VP04, and VP05

▶ Matrix, continued on next page

# Solid Wood Matrix

For Solid Hardwood Components of Seating and Tables

► Matrix, continued from previous page

Legend

- = Not available
- = Available
- ◻ = Stain color only on maple
- See specification pages in the Coalesse Specification Guides for details.

	Maple Flat-Cut – High Sheen	Maple Flat-Cut – Low Sheen	Maple Quarter-Cut – High Sheen	Maple Quarter-Cut – Low Sheen	Cherry Flat-Cut – High Sheen	Cherry Flat-Cut – Low Sheen	Cherry Quarter-Cut – High Sheen	Cherry Quarter-Cut – Low Sheen	Oak Rift-Cut – High Sheen	Oak Rift-Cut – Low Sheen	Walnut Flat-Cut – High Sheen	Walnut Flat-Cut – Low Sheen	Walnut Quarter-Cut – High Sheen	Walnut Quarter-Cut – Low Sheen	Teak Quarter-Cut – Low Sheen	Grey Ash – Low Sheen
<b>Occasional Tables</b>																
CG_1	•	•	•	•	•	•	•	•	■	■	■	■	•	•	•	•
Circa Cylinder Legs	•	•	•	•	•	•	•	•	■	■	•	•	•	•	•	•
Circa Tapered Legs	•	•	■	■	•	•	•	•	■	■	•	•	■	■	•	•
Passerelle	■	■	•	•	E	E	•	•	E	E	E	E	•	•	•	•
<b>Collaboration and Conference Tables</b>																
Potrero415 Light	•	•	•	•	•	•	•	•	■	■	•	•	•	•	•	•
Potrero415	•	•	•	•	•	•	•	•	■	■	•	•	•	•	•	•

# Solid Wood Stains Palette

For Solid Hardwood Components of Seating and Tables

► See *Solid Wood Matrix* for availability by product list, page 30.

## High Sheen



Clear Maple  
V10M

Natural Beech  
on Maple  
V11M

Medium Maple  
V12M

Natural Cherry  
V10C

Clear Cherry  
V11C

Medium Amber  
Cherry  
V12C

Dark Cherry  
V13C

Natural Walnut  
V10W

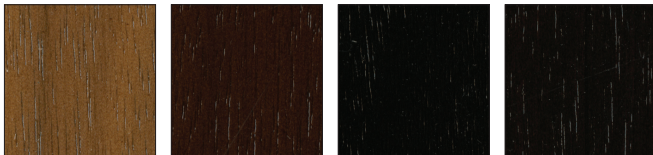

Clear Walnut  
V11W

Medium Walnut  
V12W

Black Walnut  
V13W

Dark Walnut  
V14W

Finish may be applied to different species.  
See Solid Wood Matrix for details.

## Low Sheen



Clear Maple  
V1AM

Natural Beech  
on Maple  
V1BM

Medium Maple  
V1CM

Natural Cherry  
V1AC

Clear Cherry  
V1BC

Medium Amber  
Cherry  
V1CC

Dark Cherry  
V1DC

Natural Walnut  
V1AW



Clear Walnut  
V1BW

Medium Walnut  
V1CW

Dark Walnut  
V1EW

Finish may be applied to different species.  
See Solid Wood Matrix for details.

## High Sheen



Natural Oak  
V30K

Desert Oak  
V31K

Medium Brown Oak  
V32K

Medium Gray Oak  
V33K

Black Brown Oak  
V34K

Finish may be applied to different species.  
See Solid Wood Matrix for details.

## Low Sheen



Natural Oak  
V3AK

Desert Oak  
V3BK

Medium Brown Oak  
V3CK

Medium Gray Oak  
V3DK

Black Brown Oak  
V3EK

Finish may be applied to different species.  
See Solid Wood Matrix for details.

# Veneer Matrix

For Conference and Café Tables, Storage, Casegoods, and Occasional Tables, and Seating

**Legend**

- = Not available
- = Available
- = Stain color only on maple
- = Stain color only
- ▶ See specification pages for details.

	Maple Flat-Cut – High Sheen	Maple Flat-Cut – Low Sheen	Maple Quarter-Cut – High Sheen	Maple Quarter-Cut – Low Sheen	Cherry Flat-Cut – High Sheen	Cherry Flat-Cut – Low Sheen	Cherry Quarter-Cut – High Sheen	Cherry Quarter-Cut – Low Sheen	Oak Rift-Cut – High Sheen	Oak Rift-Cut – Low Sheen	Walnut Flat-Cut – High Sheen	Walnut Flat-Cut – Low Sheen	Walnut Quarter-Cut – High Sheen	Walnut Quarter-Cut – Low Sheen	Teak Quarter-Cut – Low Sheen	Grey Ash – Low Sheen	Transolid – Solid Surface	Exclusive Finishes for Trees	Milk MDF	Black MDF	Composite Flat-Cut—Select Surfaces	Composite Quarter-Cut—Select Surfaces	Planked Veneers	Natural Veneers	Ash – Quarter-Cut	Premium Wood—Quarter-Cut
<b>Tables and Casegoods</b>																										
Bob	■	■	■	■	■	■	■	■	■	■	■	■	■	■	•	•	■	•	•	•	■	■	■	■	■	■
CG_1	■	■	■	■	■	■	■	■	■	■	■	■	■	■	•	•	■	•	•	•	■	■	■	■	■	■
Circa	•	•	■	■	•	•	•	•	■	■	•	•	■	■	•	•	•	•	•	•	•	•	•	•	•	•
Coalesse Ensemble In-line Tables and Planter	■	■	■	■	■	■	■	■	■	■	■	■	■	■	•	•	•	•	•	•	•	•	•	■	■	■
Diekman	■	■	•	•	■	■	•	•	■	■	■	■	■	■	•	•	•	•	•	•	•	•	•	•	•	•
E-Tables 2 Bases	■	■	■	■	■	■	■	■	■	■	■	■	■	■	•	•	•	•	•	•	•	■	■	■	■	■
E-Tables 2 Tops	■	■	■	■	■	■	■	■	■	■	■	■	■	■	•	•	•	•	•	•	•	■	■	■	■	■
Enea Lottus	■	■	■	■	■	■	■	■	■	■	■	■	■	■	•	•	•	•	•	•	•	■	■	■	■	■
Exponents Whiteboard and Mobile Display	■	■	■	■	■	■	■	■	■	■	■	■	■	■	•	•	■	•	■	■	■	■	■	■	■	■
Host Bases	■	■	■	■	■	■	■	■	■	■	■	■	■	■	•	•	•	•	•	•	•	•	•	■	■	■
Host Tops	■	■	■	■	■	■	■	■	■	■	■	■	■	■	•	•	•	•	•	•	•	•	■	■	■	■
Lagunitas Focus Nook	■	■	■	■	■	■	■	■	■	■	■	■	■	■	•	•	•	•	•	•	•	■	■	■	■	■
Lagunitas Tables	■	■	■	■	■	■	■	■	■	■	■	■	■	■	•	•	•	•	•	•	•	■	■	■	■	■
Montara650	■	■	■	■	■	■	■	■	■	■	■	■	■	■	•	•	•	•	•	•	•	■	■	■	■	■
Potrero415	■	■	■	■	■	■	■	■	■	■	■	■	■	■	•	•	■	•	•	•	•	■	■	■	■	■
Potrero415 Light	■	■	■	■	■	■	■	■	■	■	■	■	■	■	•	•	■	•	•	•	•	■	■	■	■	■
Sebastopol	■	■	■	■	■	■	■	■	■	■	■	■	■	■	•	•	•	•	•	•	•	■	■	■	■	■
Sistema**	•	•	•	•	•	•	•	•	•	■	•	•	•	•	•	•	•	•	•	•	•	•	•	•	•	•
Storage, Bench, and Lectern	■	■	■	■	■	■	■	■	■	■	■	■	■	■	•	•	■	•	•	•	•	■	■	■	■	■
SW_1	■	■	■	■	■	■	■	■	■	■	■	■	■	■	•	•	■	•	•	•	•	■	■	■	■	■
Trees	•	•	•	•	•	•	•	•	•	•	•	•	•	•	•	•	■	•	•	•	•	•	•	•	•	•
<b>Seating</b>																										
Enea	■	■	•	•	■	■	•	•	■	■	■	■	■	•	•	•	•	•	•	•	•	•	•	•	•	•
Enea Café Wood Stool*	•	•	•	•	•	•	•	•	•	■	•	•	•	•	•	•	•	•	•	•	•	•	•	•	•	•
Montara650**	•	•	•	•	•	•	•	•	•	■	•	•	•	•	•	•	•	•	•	•	•	•	•	•	•	•
Sistema Lounge System **	•	•	•	•	•	•	•	•	•	■	•	•	•	•	•	•	•	•	•	•	•	•	•	•	•	•

\* V3AK Natural Oak only

\*\* Select colors only: VP01, VP02, VP03, VP04, and VP05

# Veneer Palette

For Conference and Multipurpose Tables, Storage, Casegoods, Occasional Tables, and Seating

► See *Veneer Matrix* for availability by product list, page 33.

## Flat-Cut – High Sheen



Clear Maple  
V10M

Natural Beech  
on Maple  
V11M

Medium Maple  
V12M

Natural Cherry  
V10C

Clear Cherry  
V11C

Medium Amber  
Cherry  
V12C

Dark Cherry  
V13C

Natural Walnut  
V10W

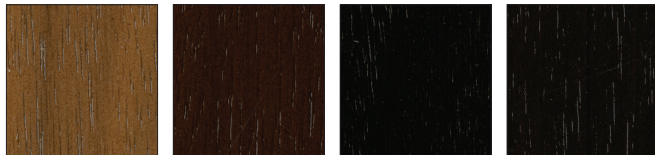

Clear Walnut  
V11W

Medium Walnut  
V12W

Black Walnut  
V13W

Dark Walnut  
V14W

## Flat-Cut – Low Sheen



Clear Maple  
V1AM

Natural Beech  
on Maple  
V1BM

Medium Maple  
V1CM

Natural Cherry  
V10C

Clear Cherry  
V1BC

Medium Amber  
Cherry  
V1CC

Dark Cherry  
V1DC

Natural Walnut  
V1AW

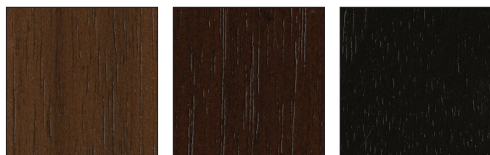

Clear Walnut  
V1BW

Medium Walnut  
V1CW

Dark Walnut  
V1EW

## Rift-Cut – High Sheen



Natural Oak  
V30K

Desert Oak  
V31K

Medium Brown Oak  
V32K

Medium Gray Oak  
V33K

Black Brown Oak  
V34K

## Rift-Cut – Low Sheen



Natural Oak  
V3AK

Desert Oak  
V3BK

Medium Brown Oak  
V3CK

Medium Gray Oak  
V3DK

Black Brown Oak  
V3EK

# Veneer Palette

For Conference and Multipurpose Tables, Storage, Casegoods, Occasional Tables, and Seating

► See *Veneer Matrix* for availability by product list, page 33.

## Quarter-Cut – High Sheen



Clear Maple  
V20M

Natural Beech  
on Maple  
V21M

Medium Maple  
V22M

Natural Cherry  
V20C

Clear Cherry  
V21C

Medium Amber  
Cherry  
V22C

Dark Cherry  
V23C

Natural Walnut  
V20W

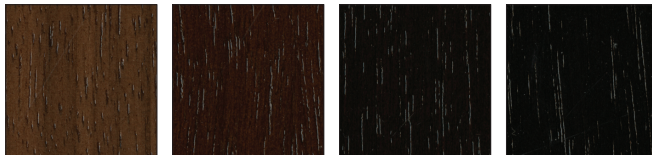

Clear Walnut  
V21W

Medium Walnut  
V22W

Dark Walnut  
V24W

Black Walnut  
V23W

## Quarter-Cut – Low Sheen

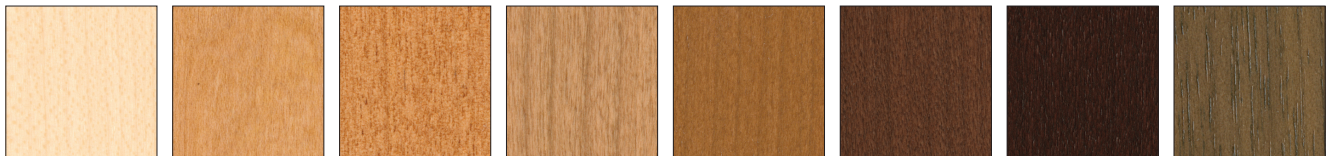

Clear Maple  
V2AM

Natural Beech  
on Maple  
V2BM

Medium Maple  
V2CM

Natural Cherry  
V2AC

Clear Cherry  
V2BC

Medium Amber  
Cherry  
V2CC

Dark Cherry  
V2DC

Natural Walnut  
V2AW



Clear Walnut  
V2BW

Medium Walnut  
V2CW

Dark Walnut  
V2EW

# Veneer Palette continued

For Conference and Multipurpose Tables, Storage, Casegoods, Occasional Tables, and Seating

▶ See *Veneer Matrix* for availability by product list, page 33.

---

## Steelcase Veneers (open pore only)

---

### Ash – Quarter-Cut



Ash **E**  
3042

### Cherry – Flat-Cut

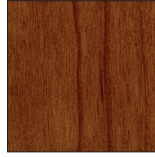

Clear Cherry  
3402

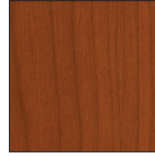

Natural Cherry **E**  
3412

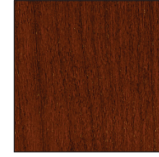

Medium Cherry  
3422

---

### Maple – Flat-Cut



Clear Maple  
3522



Blonde on Maple **E**  
3592

---

### Maple – Quarter-Cut



Clear Maple  
3222



Blonde on Maple **E**  
3292

---

### Walnut – Flat-Cut



Graphite Walnut  
3062

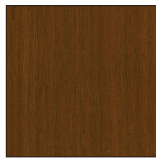

Clear Walnut  
3702



Natural Walnut  
3712



Medium Walnut **E**  
3752

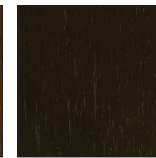

Dark Walnut  
3762



Medium Mahogany  
on Walnut  
3772

---

### Walnut – Quarter-Cut



Clear Walnut  
3302



Natural Walnut  
3312

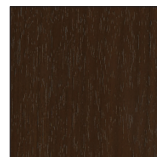

Medium Walnut **E**  
3352



Dark Walnut  
3362



Medium Mahogany  
on Walnut  
3372



Graphite Walnut  
3382

**E** = Excluded

# Veneer Palette

For Conference and Multipurpose Tables, Storage, Casegoods, Occasional Tables, and Seating

► See *Veneer Matrix* for availability by product list, page 33.

---

## Steelcase Veneers (open pore only)

---

### Premium Wood – Quarter-Cut



Figured Anegre  
3832

### Oak – Rift-Cut



Desert Oak  
3602



Medium Cherry  
3422

---

## Planked Veneer



Planked Cherry  
3P41



Planked Maple  
3P51



Planked Oak  
3P61



Planked Walnut  
3P71

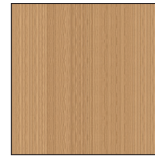

Unmarked Oak  
3VFX

---

## Natural Veneer



Quarter-Cut Blanch  
Maple  
32A2

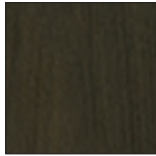

Quarter-Cut  
Thunder Walnut  
33A2



Flat-Cut Blanch  
Maple  
35A2



Rift-Cut Volcanic  
Oak  
36A2



Flat-Cut Thunder  
Walnut  
37A2

---

## Composite, Flat-Cut—Select Surfaces



Oak  
3JDX



Walnut  
3JJX



Graphite  
3LAX



Medium Cherry  
3LCX



Espresso  
3LHX

# Veneer Palette *continued*

For Conference and Multipurpose Tables, Storage, Casegoods, Occasional Tables, and Seating

▶ See *Veneer Matrix* for availability by product list, page 33.

## Composite, Quarter-Cut—Select Surfaces



European Walnut  
3F8X

Zebrano  
3GGX

Oak  
3HGX

Walnut  
3HVX

Clear Walnut  
3LBX

Natural Walnut  
3LDX

Desert Oak  
3LEX

Chai  
3LGX

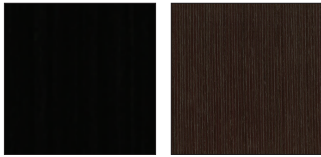

Ebony  
3LJX

Night Cerused Oak  
3ZNX

## Exponents Whiteboard and Mobile Display Painted MDF



Milk  
V145

Black  
V197

## Enea Altzo943, Montara650 Tables and Seating, and Sistema Lounge System

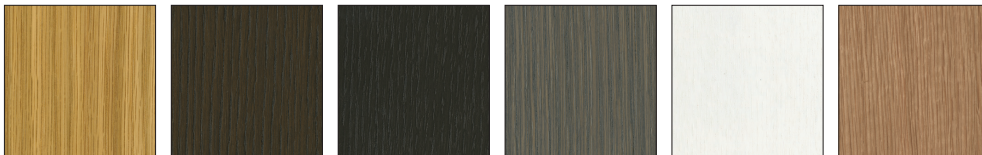

Light Oak  
VP01

Smoked Oak  
VP02

Black Oak\*  
VP03

Grey Oak  
VP04

White Oak  
VP05

Rift-Cut Oak\*\*  
V3AK

\* VP03 Black Oak is equivalent in color to Steelcase finish 36A2 Volcanic Ash.

\*\* V3AK Rift-Cut Oak is only available on Enea Altzo943.

## Trees Embossed Wood



Medium Brown  
EWMB

Natural  
EWNT

# Laminate

## Laminate

Coalesse's grouped laminate program includes our standard laminates, Steelcase High-Pressure Laminates, and standard High-Pressure Laminates from Nevamar, Wilsonart, Formica, and Pionite.

### Standard Coalesse Laminate

#### Group 1

Coalesse High-Pressure Laminates are priced as Group 1.

High-Pressure Laminates listed below are not available on all products, check laminate matrix for availability.

- 2730 Arctic White
- 2746 Black
- 2826 White Nebula
- 2829 Poppyseed
- 2830 Charcoal
- 2884 Milk
- 2886 Maple
- 2887 Amber Cherry
- 2890 Folkstone BMW
- 2891 Ingot
- 2892 Ash
- 2895 Natural Walnut
- 2896 Dark Cork
- 2897 Desert Oak
- 2898 Satin Stainless

### Standard Steelcase Laminate

#### Group 1

All Steelcase High-Pressure Laminates may be specified on Coalesse products with exception (must be ordered as Special): Await tables and Enea Lottus tables. The use of Steelcase High-Pressure Laminate may be subject to extended lead times.

#### Fiber Laminate

- 2850 Vanadium Fiber
- 2852 Tungsten Fiber **E**
- 2854 Vellum Fiber **E**
- 2860 Granite Fiber
- 2862 Stucco Fiber **E**

#### Micro Laminate

- 2920 Marl Micro
- 2921 Gypsum Micro
- 2922 Clay Micro

#### Patina Laminate

- 2870 Blonde Bronze Patina
- 2873 Instant Iron Patina

#### Solid Laminate

- 2722 Cream **E**
- 2730 Arctic White
- 2746 Black
- 2759 Warm White
- 2811 Mist **E**
- 2883 Seagull
- 2884 Milk
- 2885 Dune
- 2HAA Persian Salt
- 2HAB Rose
- 2HAC Indigo
- 2HAD Green Citrine **E**
- 2HAE Dark Olivine
- 2HAF Cloudy
- 2HMG Merle

#### Speckle Laminate

- 2820 Coffee Speckle **E**
- 2823 Driftwood Speckle
- 2824 Smoke Speckle
- 2825 Vanadium Speckle

#### Woodgrain Laminate

- 2406 Clear Cherry **E**
- 2409 Clear Maple
- 2410 Graphite Walnut
- 2412 Natural Cherry
- 2422 Medium Cherry **E**
- 2511 Winter on Maple **E**
- 2535 Virginia Walnut
- 2536 Blackwood
- 2538 Clear Walnut
- 2592 Blonde on Maple **E**
- 2714 Natural Walnut **E**
- 2HAK Clear Oak
- 2HAN Ash Noce
- 2HAT Acacia
- 2HAW Ash Wenge
- 2HBN Bisque Noce
- 2HBW Bisque Wenge
- 2HCN Clay Noce
- 2HCW Clay Wenge
- 2HSN Storm Noce
- 2HSW Storm Wenge
- 2HWA Grey Kingswood
- 2HWB Planked Walnut
- 2HWD Resolute Walnut
- 2HWE Natural Recon
- 2HWF Smoked Walnut **E**
- 2HWU Clay
- 2HWV Chalk
- 2HZA Waxed Maple
- 2HZB Natural Ash
- 2HZC Aged Ash
- 2HZD Ashwood Oak
- 2HZE Ashwood Beige
- 2HZF White Washed Birchply

#### Group 2

##### Textured Laminate

- 2TH2 Fawn Cypress
- 2TH4 Saddle Oak
- 2TH5 Veranda Teak
- 2TH7 Walnut Heights
- 2UH1 Reclaimed Aggregate
- 2UH2 Reclaimed Gravel
- 2UH4 Cement\*
- 2UH6 Sheetrock

\*2UH4 Cement has limited availability, determined by product sizing and/or options.

#### Group 3

##### Solid Laminate

- 24H1 Satin White
- 24H2 Satin Black
- 24H3 Satin Stone
- 24H4 Satin Mocha

#### Open Line Laminates

Customers can select laminates that are not offered as standard from select suppliers. Standard grade High-Pressure laminates can be specified in Group 1 (290A) or Group 2 (290B) as indicated below (subject to availability). Group 2 laminates will have extended lead time. Select from any Coalesse or Steelcase standard edge band finish.

**Contact Customer Service at 1.800.627.6770 to verify that your laminate selection falls within the categories noted below.**

Directional patterns and woodgrains may be used on freestanding systems products, but will not be patterned matched.

Some standard High-Pressure Laminates, may not be available in the appropriate size to produce large products.

Wilsonart (Group 1)  
Standards (matte finish)  
Exceptions: High definition which must be quoted as a special. Marker board which is group 2.

Nevamar (Group 2)  
Solids (textured finish)  
Patterns (textured finish)

Formica (Group 2)  
Color portfolio (matte finish)  
Patterns (matte finish)  
Formations (matte finish)

Pionite (Group 2)  
Decorative surfaces (suede finish)

Non-Standard Laminates  
Coalesse can supply additional laminates for an upcharge. Contact your Coalesse sales consultant for a custom quotation. Custom upcharges will vary based upon the cost of the material specified and additional labor required to manufacture the products. Some non-standard laminates will not be available in the appropriate size to produce large Coalesse products. A sample of the laminate may be requested for approval. Some non-standard laminates may be subject to extended lead times.

**E** = Excluded

# High-Pressure Laminate Matrix

**Legend**

- = Not available
- = Available
- ▶ See specification pages for details.

	Standard Coalesse High-Pressure Laminate														Standard Steelcase High-Pressure Laminate														
	2730 Arctic White	2746 Black	2759 Warm White	2826 White Nebula	2829 Poppyseed	2830 Charcoal	2884 Milk	2886 Maple	2887 Amber Cherry	2890 Folkstone	2891 Ingot	2892 Ash	2895 Natural Walnut	2896 Dark Cork	2897 Desert Oak	2898 Satin Stainless	290N North Sea	2406 Clear Cherry <sup>E</sup>	2409 Clear Maple	2410 Graphite Walnut	2412 Natural Cherry	2422 Medium Cherry <sup>E</sup>	24H1 Satin White	24H2 Satin Black	24H3 Satin Stone	24H4 Satin Mocha	2511 Winter on Maple <sup>E</sup>		
<b>Seating</b>																													
Await	■	■	■	•	•	•	•	•	•	•	•	•	•	•	•	•	■	•	•	•	•	•	•	•	•	•	•	•	•
Coupe	■	■	■	•	•	•	■	•	•	■	■	■	•	•	•	•	•	•	•	•	•	•	•	•	•	•	•	•	•
Sidewalk Tablet	■	■	■	■	■	■	■	■	■	■	■	■	■	■	■	■	■	■	■	■	■	■	■	•	•	•	•	•	■
<b>Occasional Tables</b>																													
Await	■	■	■	•	•	•	•	•	•	•	•	•	•	•	•	•	■	•	•	•	•	•	•	•	•	•	•	•	•
Bob Tables	■	■	■	■	■	■	■	■	■	■	■	■	■	■	■	■	•	■	■	■	■	■	■	■	■	■	■	■	■
CG_1	■	■	■	■	■	■	■	■	■	■	■	■	■	■	■	■	•	■	■	■	■	■	■	■	■	■	■	■	■
Circa Tables	■	■	■	■	■	■	■	■	■	■	■	■	■	■	■	■	•	■	■	■	■	■	■	•	•	•	•	■	
Coalesse Ensemble In-line Tables and Planters	■	■	■	■	■	■	■	■	■	■	■	■	■	■	■	■	•	■	■	■	■	■	■	■	■	■	■	■	■
Enea Lottus	■	■	■	■	■	■	■	■	■	■	■	■	■	■	■	■	•	■	■	■	■	■	■	■	■	■	■	■	■
Lagunitas Tables	■	■	■	■	■	■	■	■	■	■	■	■	■	■	■	■	•	■	■	■	■	■	■	■	■	■	■	■	■
Lagunitas Focus Nook	■	■	■	■	■	■	■	■	■	■	■	■	■	■	■	■	•	■	■	■	■	■	■	■	■	■	■	■	■
Montara650	■	■	■	■	■	■	■	■	■	■	■	■	■	■	■	■	•	■	■	■	■	■	■	■	■	■	■	■	■
SW_1	■	■	■	■	■	■	■	■	■	■	■	■	■	■	■	■	•	■	■	■	■	■	■	■	■	■	■	■	■
<b>Tables and Casegoods</b>																													
Ballet	■	■	■	■	■	■	■	■	■	■	■	■	■	■	■	■	•	■	■	■	■	■	■	■	■	■	■	■	■
Bob Tables	■	■	■	■	■	■	■	■	■	■	■	■	■	■	■	■	•	■	■	■	■	■	■	■	■	■	■	■	■
E-Table 2 Top	■	■	■	■	■	■	■	■	■	■	■	■	■	■	■	■	•	■	■	■	■	■	■	■	■	■	■	■	■
E-Table 2 Laminate Base	■	■	■	•	•	•	■	•	•	•	•	•	•	•	■	•	•	•	■	■	■	■	■	•	•	•	•	■	
Enea Lottus	■	■	■	■	■	■	■	■	■	■	■	■	■	■	■	■	•	■	■	■	■	■	■	■	■	■	■	■	■
Host Collection	■	■	■	■	■	■	■	■	■	■	■	■	■	■	■	■	•	■	■	■	■	■	■	■	■	■	■	■	■
Montara650	■	■	■	■	■	■	■	■	■	■	■	■	■	■	■	■	•	■	■	■	■	■	■	■	■	■	■	■	■
MoreThanFive	•	•	•	•	•	•	•	•	•	•	•	•	•	•	•	•	•	•	•	•	•	•	■	■	■	■	•	■	
Potrero415	■	■	■	■	■	■	■	■	■	■	■	■	■	■	■	■	•	■	■	■	■	■	■	■	■	■	■	■	■
Potrero415 Light	■	■	■	■	■	■	■	■	■	■	■	■	■	■	■	■	•	■	■	■	■	■	■	■	■	■	■	■	■
SW_1	■	■	■	■	■	■	■	■	■	■	■	■	■	■	■	■	•	■	■	■	■	■	■	■	■	■	■	■	■
Train	■	■	■	■	■	■	■	■	■	■	■	■	■	■	■	■	•	■	■	■	■	■	■	■	■	■	■	■	■

<sup>E</sup> = Excluded

# High-Pressure Laminate Matrix

**Legend**

- = Not available
- = Available
- ▶ See specification pages for details.

Standard Steelcase High-Pressure Laminate (continued)	2535 Virginia Walnut	2536 Blackwood	2538 Clear Walnut	2592 Blonde on Maple <b>E</b>	2714 Natural Walnut <b>E</b>	2722 Cream <b>E</b>	2811 Mist <b>E</b>	2820 Coffee Speckle <b>E</b>	2823 Driftwood Speckle	2824 Smoke Speckle	2825 Vanadium Speckle	2850 Vanadium Fiber	2852 Tungsten Fiber <b>E</b>	2854 Vellum Fiber <b>E</b>	2860 Granite Fiber	2862 Stucco Fiber <b>E</b>	2870 Blonde Bronze Patina	2873 Instant Iron Patina	2883 Seagull	2885 Dune	2920 Marl Micro	2921 Gypsum Micro	2922 Clay Micro
<b>Seating</b>																							
Await	•	•	•	•	•	•	•	•	•	•	•	•	•	•	•	•	•	•	•	•	•	•	•
Coupe	•	•	•	•	•	•	•	•	•	•	•	•	•	•	•	•	•	•	•	•	•	•	•
Sidewalk Tablet	•	•	■	■	■	■	■	■	■	■	■	■	■	■	■	■	■	■	■	■	■	■	■
<b>Occasional Tables</b>																							
Await	•	•	•	•	•	•	•	•	•	•	•	•	•	•	•	•	•	•	•	•	•	•	•
Bob Tables	■	■	■	■	■	■	■	■	■	■	■	■	■	■	■	■	■	■	■	■	■	■	■
CG_1	■	■	■	■	■	■	■	■	■	■	■	■	■	■	■	■	■	■	■	■	■	■	■
Circa Tables	■	■	■	■	■	■	■	■	■	■	■	■	■	■	■	■	■	■	■	■	■	■	■
Coalesse Ensemble In-line Tables and Planters	■	■	■	■	■	■	■	■	■	■	■	■	■	■	■	■	■	■	■	■	■	■	■
Enea Lottus	■	■	■	■	■	■	■	■	■	■	■	■	■	■	■	■	■	■	■	■	■	■	■
Lagunitas Tables	■	■	■	■	■	■	■	■	■	■	■	■	■	■	■	■	■	■	■	■	■	■	■
Lagunitas Focus Nook	■	■	■	■	■	■	■	■	■	■	■	■	■	■	■	■	■	■	■	■	■	■	■
Montara650	■	■	■	■	■	■	■	■	■	■	■	■	■	■	■	■	■	■	■	■	■	■	■
SW_1	■	■	■	■	■	■	■	■	■	■	■	■	■	■	■	■	■	■	■	■	■	■	■
<b>Tables and Casegoods</b>																							
Ballet	■	■	■	■	■	■	■	■	■	■	■	■	■	■	■	■	■	■	■	■	■	■	■
Bob Tables	■	■	■	■	■	■	■	■	■	■	■	■	■	■	■	■	■	■	■	■	■	■	■
E-Table 2 Top	■	■	■	■	■	■	■	■	■	■	■	■	■	■	■	■	■	■	■	■	■	■	■
E-Table 2 Laminate Base	■	■	■	•	•	•	•	•	•	•	•	•	•	•	•	•	•	•	•	•	•	•	•
Enea Lottus	■	■	■	■	■	■	■	■	■	■	■	■	■	■	■	■	■	■	■	■	■	■	■
Host Collection	■	■	■	■	■	■	■	■	■	■	■	■	■	■	■	■	■	■	■	■	■	■	■
Montara650	■	■	■	■	■	■	■	■	■	■	■	■	■	■	■	■	■	■	■	■	■	■	■
Potrero415	■	■	■	■	■	■	■	■	■	■	■	■	■	■	■	■	■	■	■	■	■	■	■
Potrero415 Light	■	■	■	■	■	■	■	■	■	■	■	■	■	■	■	■	■	■	■	■	■	■	■
SW_1	■	■	■	■	■	■	■	■	■	■	■	■	■	■	■	■	■	■	■	■	■	■	■
Train	■	■	■	■	■	■	■	■	■	■	■	■	■	■	■	■	■	■	■	■	■	■	■

**E** = Excluded





# High-Pressure Laminate Palette *continued*

▶ See *High-Pressure Laminate Matrix* for availability by product list, page 40.

## Standard Coalesse High-Pressure Laminate



\*Available on Await only.

## Standard Steelcase High-Pressure Laminate

### Laminate

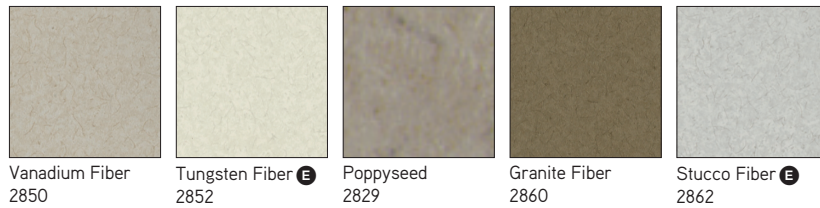

### Micro Laminate

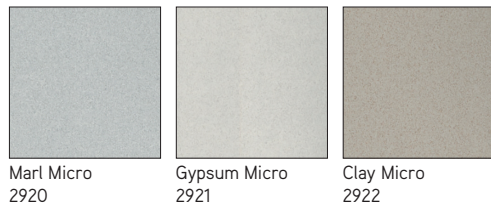

### Speckle Laminate



**E** = Excluded

# High-Pressure Laminate Palette

► See *High-Pressure Laminate Matrix* for availability by product list, page 40.

---

## Standard Steelcase High-Pressure Laminate, continued

---

### Micro Laminate

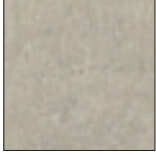

Blonde Bronze  
Patina  
2870



Instant Iron Patina  
2873

---

### Solid Laminate

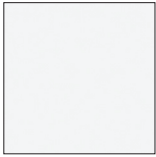

Satin White  
24H1



Satin Black  
24H2



Satin Stone  
24H3



Satin Mocha  
24H4



Cream <sup>E</sup>  
2722



Mist <sup>E</sup>  
2811

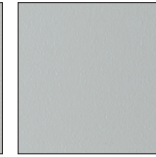

Seagull  
2883



Dune  
2885

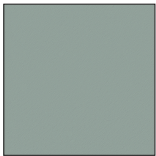

Persian Salt  
2HAA

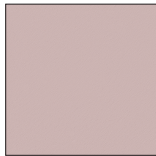

Rose  
2HAB



Indigo  
2HAC



Green Citrine <sup>E</sup>  
2HAD



Dark Olivine  
2HAE

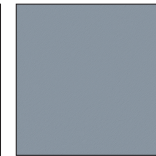

Cloudy  
2HAF



Merle  
2HMG

Laminate

<sup>E</sup> = Excluded

# High-Pressure Laminate Palette *continued*

► See *High-Pressure Laminate Matrix* for availability by product list, page 40.

## Woodgrain Laminate



## Textured Laminate



<sup>E</sup> = Excluded

Coalesse

# High-Pressure Laminate Palette

Laminate





# Laminate Edge Band Matrix *continued*

**Legend**

- = Not available
- = Available
- ▶ See specification pages for details.

6710 Storm Noce
6D10 Silver Metallic
6D11 Black
6D12 White
6T02 Fawn Cypress
6T04 Saddle Oak
6T05 Veranda Teak
6T07 Walnut Heights
2UH1 Reclaimed Aggregate
2UH2 Reclaimed Gravel
2UH4 Cement
2UH6 Sheetrock

**Occasional Tables**

Await Table 3 mm Edge	•	•	•	•	•	•	•	•	•	•	•	•
Enea Lottus	•	•	•	•	•	•	•	•	•	•	•	•
Montara650	■	•	•	•	■	■	■	■	■	■	■	■

**Tables and Casegoods**

Await Table 3 mm Edge	•	•	•	•	•	•	•	•	•	•	•	•
Ballet Ribbed Vinyl Edge	•	•	•	•	•	•	•	•	•	•	•	•
Bob Tables	■	•	•	•	■	■	■	■	■	■	■	■
Coalesse Ensemble In-line Tables and Planters	■	•	•	•	■	■	■	■	■	■	■	■
E-Table 2 Convex Vinyl Edge	•	•	•	•	•	•	•	•	•	•	•	•
E-Table 2 3 mm Edge	■	•	•	•	■	■	■	■	■	■	•	■
Enea Lottus Phenolic Edge	•	•	•	•	•	•	•	•	•	•	•	•
Host Collection	•	•	•	•	•	•	•	•	•	•	•	•
Lagunitas Table 3 mm Edge	■	•	•	•	■	■	■	■	■	■	■	■
Lagunitas Focus Nook	■	•	•	•	■	■	■	■	■	■	■	■
Montara650	■	•	•	•	■	■	■	■	■	■	■	■
Potrero415	■	•	•	•	■	■	■	■	■	■	•	■
Potrero415 Light	■	•	•	•	■	■	■	■	■	■	■	■
SW_1	■	•	•	•	■	■	■	■	■	■	■	■
Train Signature Edge	•	•	•	•	•	•	•	•	•	•	•	•

Coalesse

# Laminate Edge Band Matrix

Laminate

# Recommended Worksurface 3 mm Edge Finishes

For E-Table2, Lagunitas, Montara650, Potrero415, and SW\_1

## Recommended Edge Colors—Coalesse and Steelcase High-Pressure Laminate

### Edges

The recommended edge color will complement the laminate color you specify. Edge color is specified separately.

Laminate Color	Recommended 3 mm Edge Color
<b>Solid Laminate</b>	
Coalesse:	
2830 Charcoal	6000 Black
2890 Folkstone	6086 Folkstone
2891 Ingot	6012 Ingot
2892 Ash	6011 Ash
<b>Pattern Laminate</b>	
Coalesse:	
2826 White Nebula	6635 Dawn <b>E</b>
2829 Poppyseed	6249 Platinum Solid
2896 Dark Cork	6695 Midnight Solid
2898 Satin Stainless	6093 Dove Grey
<b>Woodgrain Laminate</b>	
Coalesse:	
2886 Maple	6091 Fusion Maple
2887 Amber Cherry	6090 Amber Cherry
2895 Natural Walnut	6012 Ingot
2897 Desert Oak	6128 Taupe
<b>Solid Laminate</b>	
Steelcase:	
24H1 Satin White	6009 Arctic White
24H2 Satin Black	6000 Black
24H3 Satin Stone	6169 Stone
24H4 Satin Mocha	6170 Mocha
2722 Cream <b>E</b>	6631 Cream <b>E</b>
2730 Arctic White	6009 Arctic White
2746 Black	6000 Black
2759 Warm White	6655 Warm White
2811 Mist <b>E</b>	6636 Mist
2883 Seagull	6053 Seagull
2884 Milk	6052 Milk
2885 Dune	6654 Sand
2HAA Persian Salt	61AA Persian Salt
2HAB Rose	61AB Rose
2HAC Indigo	61AC Indigo
2HAD Green Citrine <b>E</b>	61AD Green Citrine <b>E</b>
2HAE Dark Olivine	61AE Dark Olivine
2HAF Cloudy	61AF Cloudy
2HMG Merle	6527 Merle
2HWU Clay	66WU Clay
2HWV Chalk	66WV Chalk
<b>Woodgrain Laminate</b>	
Steelcase:	
2406 Clear Cherry <b>E</b>	6234 Clear Cherry
2409 Clear Maple	6237 Clear Maple
2410 Graphite Walnut	6231 Graphite Walnut
2412 Natural Cherry	6034 Natural Cherry
2422 Medium Cherry <b>E</b>	6036 Medium Cherry
2511 Winter on Maple <b>E</b>	6037 Winter on Maple
2535 Virginia Walnut	6242 Virginia Walnut
2536 Blackwood	6243 Blackwood
2538 Clear Walnut	6245 Clear Walnut
2592 Blonde on Maple <b>E</b>	6038 Blonde on Maple <b>E</b>
2714 Natural Walnut <b>E</b>	6041 Natural Walnut <b>E</b>

**E** = Excluded

# Recommended Worksurface 3 mm Edge Finishes

For E-Table2, Lagunitas, Montara650, Potrero415, and SW\_1

## Recommended Edge Colors—Coalesse and Steelcase High-Pressure Laminate, continued

### Edges

The recommended edge color will complement the laminate color you specify. Edge color is specified separately

Laminate Color	Recommended 3 mm Edge Color
<b>Woodgrain Laminate, continued</b>	
Steelcase:	
2HAK Clear Oak	6219 Clear Oak
2HAN Ash Noce	6707 Ash Noce
2HAT Acacia	6213 Acacia
2HAW Ash Wenge	6703 Ash Wenge
2HBN Bisque Noce	6708 Bisque Noce
2HBW Bisque Wenge	6705 Bisque Wenge
2HCN Clay Noce	6709 Clay Noce
2HCW Clay Wenge	6706 Clay Wenge
2HSN Storm Noce	6710 Storm Noce
2HSW Storm Wenge	6704 Storm Wenge
2HZA Waxed Maple	6X50 Waxed Maple
2HZB Natural Ash	6X51 Natural Ash
2HZC Aged Ash	6X10 Aged Ash
2HZD Ashwood Oak	6X52 Ashwood Oak
2HZE Ashwood Beige	6X53 Ashwood Beige
2HZF White Washed Birchply	6X54 White Washed Birchply
<b>Fiber Laminate</b>	
Steelcase:	
2850 Vanadium Fiber	6654 Sand
2854 Vellum Fiber <b>E</b>	6655 Warm White
2860 Granite Fiber	6000 Black
2862 Stucco Fiber <b>E</b>	6053 Seagull
<b>Micro Laminate</b>	
Steelcase:	
2920 Marl Micro	6053 Seagull
2921 Gypsum Micro	6654 Sand
2922 Clay Micro	6654 Sand
<b>Patina Laminate</b>	
Steelcase:	
2870 Blonde Bronze Patina	6654 Sand
2873 Instant Iron Patina	6527 Merle
<b>Speckle Laminate</b>	
Steelcase:	
2820 Coffee Speckle <b>E</b>	6631 Cream <b>E</b>
2823 Driftwood Speckle	6631 Cream <b>E</b>
2824 Smoke Speckle	6636 Mist
2825 Vanadium Speckle	6619 Ice <b>E</b>
<b>Textured Laminate</b>	
Steelcase:	
2TH2 Fawn Cypress	6T02 Fawn Cypress
2TH4 Saddle Oak	6T04 Saddle Oak
2TH5 Veranda Teak	6T05 Veranda Teak
2TH7 Walnut Heights	6T07 Walnut Heights
2UH1 Reclaimed Aggregate	6T08 Reclaimed Aggregate
2UH2 Reclaimed Gravel	6T09 Reclaimed Gravel
2UH4 Cement	6T10 Cement
2UH6 Sheetrock	6T12 Sheetrock

**E** = Excluded

# Glass

## Glass

Not all glass selections are available on every product. Refer to glass matrix for availability by product.

### Coalesse Back-Painted Glass

- 6720 Sand
- 6721 Pewter
- 6722 Mojave
- 6723 Terra
- 6724 Jade
- 6725 Ocean
- ACM Moonlight
- ACS Sage
- ACP Poppy
- ACG Goldenrod
- ACB Black
- ACC Sea Salt/Crystal Spring

### Steelcase Back-Painted Glass

- 6586 Green Citrine
- 6BB1 Cloud
- 6BB2 Rose Quartz
- 6BB3 Olivine
- 6BB4 Electric Indigo

### Glass

- 6511 Acid Etched
- 651A Acid Etched Smoked
- AC Absolute Clear
- CG Clear Green



# Glass Palette

► See *Glass Matrix* for availability by product list, page 55.

## Coalesse Back-Painted Glass

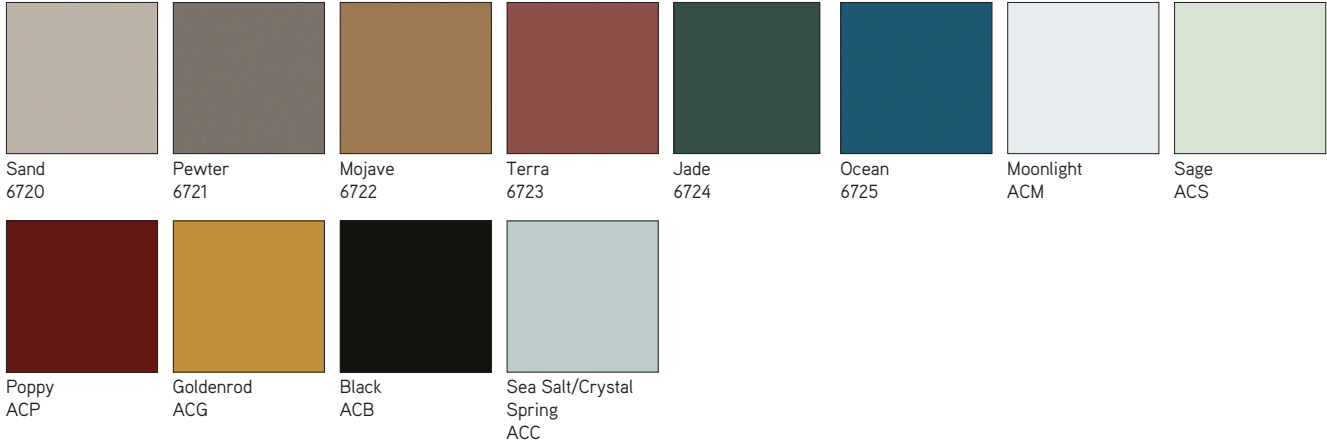

## Steelcase Back-Painted Glass

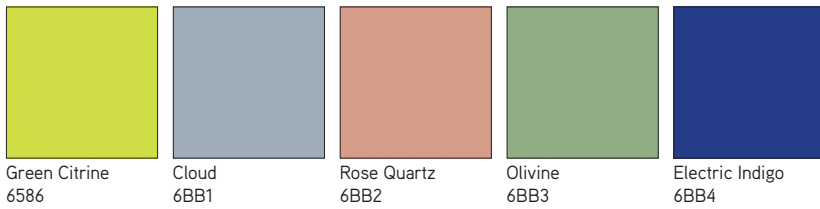

## Glass

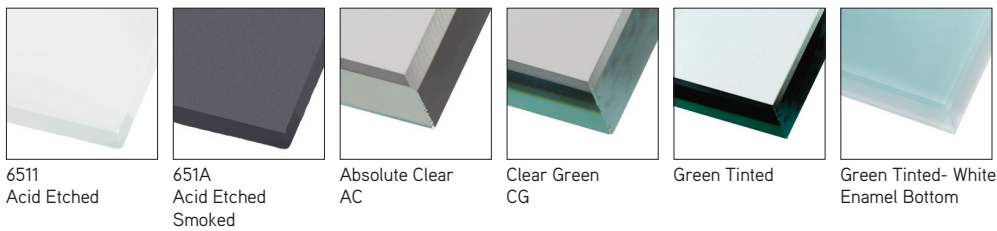

# Metal/Paint

## Metal/Paint

Coalesse powder coats all painted metal components for an exceptionally durable, environmentally responsible finish — eliminating VOC's (volatile organic compounds) from being released into the environment. Electrostatically charged powder coat material is applied to an exacting thickness and then temperature baked, resulting in a smooth, flawless finish that is abrasion and impact resistant. The following Coalesse metal finishes are available:

## Paint

### Coalesse Standard Paint—Neutrals

#### Group 1

4138	Graphite Gloss
4140	Arctic White Gloss
4141	Platinum Matte
4142	Platinum Gloss
4144	Black Gloss (formerly anthracite gloss)
4145	Milk Gloss
4146	Champagne Matte
4147	Champagne Gloss
4180	Graphite Matte
4242	Milk Matte
4710	Low Gloss Black
7196	Midnight Brown Textured
7197	Anthracite Textured

### Coalesse Standard Paint—Colors

#### Group 1

4065	Blue Ink Textured
4066	Ocean Textured
4067	Ice Textured
4068	Olive Textured
4069	Honey Textured
4070	Currant Textured
4071	Saffron Textured

### Steelcase Paint

#### Accent Paints

##### Group 3

1ATG	Rose Quartz
4AV3	Blue Jay
4AV4	Baltic
4AX1	Citron
4AY2	Chili
4AZ5	Marlin
4CZ5	Honey
4CZ6	Lagoon
4CZ8	Light Peacock

## Lux Coatings

### Group 3

4B20	Obsidian
4B22	Matte Brass
4B23	Burnished Bronze
4B24	Night Bronze
4B25	Matte Copper
4B26	Smoked Mica
4B29	Cast Iron

#### Applies to: Enea Lottus

4062	Anthracite Grey Textured
4063	Cool Grey Textured
4064	Sand Textured
4218	Platinum Silver
7207	Black Textured
7241	Arctic White Textured

#### Applies to: Enea café wood stool

(Available on seat casting only)

4062	Anthracite Grey Textured
7207	Black
7241	Arctic White

#### Applies to: Exponents (Base, Accent Ribbon, Handle, and Grommet)

4135	Black Matte
4141	Platinum Matte

#### Applies to: Exponents mobile displays (Base, Handle, and Inner Frame)

4135	Black Matte
4145	Milk Gloss

#### Applies to: LessThanFive Essential Series

4283	Cloud Matte
4284	Sand Matte
4285	Black Matte
4286	Ice Matte

#### Applies to: LessThanFive

4287	Slate Blue Matte
4288	Fern Matte
4289	Lemongrass Matte
4290	Coral Matte
4291	Poppy Matte
4292	Currant Matte
4293	Black Fade Matte
4294	White Fade Matte

#### Applies to: MoreThanFive

7207	Black Textured
------	----------------

## Metal

### Polished Aluminum

Applies to: Lox chair, Potrero415, and Bindu conference bases

8046	Polished Aluminum
------	-------------------

Applies to: Bob, SW\_1, and Massaud conference bases

8040	Aluminum Matte Polished
------	-------------------------

### Chrome

9201	Chrome
9207	Polished trivalent chrome
9208	Etched trivalent chrome

### Potrero415 and Potrero415 Light Leg Rings

9201	Chrome
9260	Black Chrome
9261	Copper

## Carbon Weave

### LessThanFive Woven Carbon Fiber

4233 Carbon Weave\*

\*4233 Carbon Weave has a clear coat finish over woven carbon fiber.

# Custom Paint

## PerfectMatch

### Group 3

#### Custom Capabilities

PerfectMatch Custom Color empowers more personal expression by expanding your color choices through our custom capabilities. Choose any standard paint color or any color to match on select, preset Coalesse products, through a Group 3 paint upcharge. Consult the paint matrix for eligible products and the Coalesse specification guides for pricing.

*Tip: Other Coalesse product lines can be quoted through Specials.*

#### Gloss Levels

Custom color requests can be matched in a smooth, non-metallic finish with a gloss (40% gloss level) or matte (12% gloss level) finish. Metallic paints are not available through the custom color program, but can be matched in an opaque, non-metallic finish.

#### Strike-off Sample

Strike-off samples are not required for standard Coalesse or Steelcase finishes. Pantone® color matches do not require approval, but may be requested at the cost listed below. All other color match requests require a strike-off and customer approval of the strike-off. Strike-offs are produced within 2 weeks and are \$500 net per color matched. A dealer PO number is required to initiate the process. We have the following Pantone color books to reference: solid colors (coated and uncoated), home interiors (lacquered on paper), neon/pastel (coated and uncoated), and metallic (coated). For all other matches, a 2" x 2" representation of the color to be matched is needed. A color card/chip is recommended, but fabrics, carpets, accessories, or other samples can be used.

#### Commercially Accepted Tolerances

The color match from the custom color sample to actual production will be within commercially accepted tolerances. Custom paint colors are formulated to minimize shifts under different lighting conditions. Particular care should be taken if high-intensity discharge light is used at the installation because it can give the appearance of a mismatch between color sample and product.

#### Custom Color Request Process

1. Initiate a custom color request through our Concierge Specials team:  
1.800.627.6770  
specialorders@coalesse.com
  - Include Pantone reference number
  - If sending in a physical sample to be matched, please contact our Concierge Specials team for the ship-to address.
  - If strike-off is required or requested, include dealer PO number to charge \$500 net fee.
  - Color match requests are processed within two weeks of request, or receipt of physical samples.
2. Upon completion of match or strike-off approval, a special paint finish code will be made available for order entry.
3. Use the custom color finish code to place your order:
  - Group 3 paint upcharge will apply
  - Select custom paint finish 4990 (Group 3 paint) and then enter custom color finish code that has been provided.
  - If a Steelcase PerfectMatch paint has already been approved with ID number, this code can be used to place an order.
  - Additional lead time of 20 working days added to standard published lead time after order is received.

Coalesse

# Custom Paint



# Metal/Paints Matrix

**Legend**

- = Not available
- = Available
- ▶ See specification pages for details.

	Coalesse Metals										Custom Paint		Steelcase Paint	
	8040 Aluminum Matte Polished	8046 Polished Aluminum	9201 Chrome	9207 Polished Trivalent Chrome	9208 Etched Trivalent Chrome	9238 Brushed Nickel	9251 Brushed Aluminum	9260 Black Chrome	9261 Copper	Potrero415 Exclusives	PerfectMatch Custom Color	Accent Paints	Lux Coatings*	
<b>Seating</b>														
Bindu Conference	•	■	•	•	•	•	•	•	•	•	•	•	•	
Bindu Guest	•	•	•	•	•	•	•	•	•	•	•	•	•	
Bob	■	•	•	•	•	•	•	•	•	•	■	■	•	
Capa	•	•	•	■	■	•	•	•	•	•	•	•	•	
Chord	•	■	•	•	•	•	•	•	•	•	•	•	•	
Circa	•	•	•	•	•	•	•	•	•	•	■	■	•	
Coalesse Ensemble	•	•	•	•	•	•	•	•	•	•	■	■	•	
Coupe	•	•	•	•	•	•	•	•	•	•	•	•	•	
Enea	•	•	•	•	•	•	•	•	•	•	•	•	•	
Enea Café Wood Stool	•	•	■	•	•	•	•	•	•	•	■	■	•	
Enea Lottus	•	•	•	•	•	•	•	•	•	•	■	■	•	
Lagunitas	•	•	•	•	•	•	•	•	•	•	•	•	•	
LessThanFive	•	•	•	•	•	•	•	•	•	•	•	•	•	
LessThanFive Essential	•	•	•	•	•	•	•	•	•	•	•	•	•	
Lox Chair	•	■	•	•	•	•	•	•	•	•	•	•	•	
Marien152	•	•	■	•	•	•	•	•	•	•	■	■	•	
Massaud Conference	■	•	•	•	•	•	•	•	•	•	■	■	•	
Massaud Lounge	•	•	•	•	•	•	•	•	•	•	■	■	•	
Millbrae	•	•	•	•	•	•	•	•	•	•	■	■	•	
Montara650	•	•	■	•	•	•	•	•	•	•	■	■	•	
Sistema Lounge System	•	•	•	•	•	•	•	•	•	•	■	■	•	
SW_1	■	•	•	•	•	•	•	•	•	•	•	•	•	
Switch	•	•	•	■	■	•	•	•	•	•	•	•	•	
Visalia	•	•	•	•	•	•	•	•	•	•	■	■	•	
Wrapp	•	•	•	■	•	•	•	•	•	•	•	•	•	
<b>Occasional Tables</b>														
Bob	■	•	•	•	•	•	•	•	•	•	■	■	•	
Circa	•	•	•	•	•	•	•	•	•	•	•	•	•	
Enea Lottus	•	•	•	•	•	•	•	•	•	•	■	■	•	
Lagunitas	•	•	•	•	•	•	•	•	•	•	■	■	•	
Millbrae	•	•	•	•	•	•	•	•	•	•	■	■	•	
Montara650	•	•	•	•	•	•	•	•	•	•	■	■	•	
Switch	•	•	•	■	■	•	•	•	•	•	•	•	•	
SW_1	■	•	•	•	•	•	•	•	•	•	•	•	•	

\* Lux Coatings are not available on Montara650 54" or 60" round work-height tables.

# Metal/Paints Matrix *continued*

**Legend**

- = Not available
- = Available
- ▶ See specification pages for details.

**Tables and Casegoods**

	Coalesse Standard Paint—Neutrals														Coalesse Standard Paint—Colors										Product Line Exclusives				
	4135 Black Matte	4138 Graphite Gloss	4140 Arctic White Gloss	4141 Platinum Matte	4142 Platinum Gloss	4144 Black Gloss	4145 Milk Gloss	4146 Champagne Matte	4147 Champagne Gloss	4148 Midnight Brown Gloss	4180 Graphite Matte	4193 Midnight Brown Matte	4242 Milk Matte	4710 Low Gloss Black	7196 Midnight Brown Textured	7197 Anthracite Textured	4065 Blue Ink Textured	4066 Ocean Textured	4067 Ice Textured	4068 Olive Textured	4069 Honey Textured	4070 Currant Textured	4071 Saffron Textured	LessThanFive Exclusive Finishes	LessThanFive Essential Exclusive Finishes	Enea Exclusive Finishes	Enea Café Wood Exclusive Finishes	MoreThanFive Exclusive Finishes	
Ballet	•	■	■	■	■	■	■	■	■	■	•	•	•	•	■	■	•	•	•	•	•	•	•	•	•	•	•	•	
Bob	•	■	•	■	■	■	■	■	■	■	■	■	■	■	■	■	■	■	■	■	■	■	■	■	•	•	•	•	
CG_1	•	•	•	■	•	•	•	•	•	■	■	■	■	■	•	•	•	•	•	•	•	•	•	•	•	•	•	•	
E-Table 2	•	■	■	■	■	■	■	■	■	■	•	•	•	■	■	■	•	•	•	•	•	•	•	•	•	•	•	•	
Enea Lottus	•	•	■	•	■	■	■	•	■	•	•	•	•	•	•	•	■	■	■	■	■	■	■	•	•	•	•	■	
Exponents	■	•	•	■	•	•	•	•	•	•	•	•	•	•	•	•	•	•	•	•	•	•	•	•	•	•	•	•	
Exponents Mobile Display	■	•	•	•	•	•	■	•	•	•	•	•	•	•	•	•	•	•	•	•	•	•	•	•	•	•	•	•	
Lagunitas	•	■	■	■	■	■	■	■	■	■	■	■	■	■	■	■	■	■	■	■	■	■	■	•	•	•	•	•	
Lagunitas Focus Nook	•	•	•	•	•	•	•	•	•	■	•	■	■	■	•	•	•	•	•	•	•	•	•	•	•	•	•	•	
Millbrae	•	■	•	■	•	■	■	•	■	■	■	■	■	■	■	■	■	■	■	■	■	■	■	•	•	•	•	•	
Montara650*	•	■	•	•	•	■	■	•	■	•	■	■	■	■	■	■	■	■	■	■	■	■	■	•	•	•	•	•	
MoreThanFive	•	•	•	•	•	•	•	•	•	•	•	•	•	•	•	•	•	•	•	•	•	•	•	•	•	•	•	■	
Potrero415	•	■	•	•	■	■	■	•	■	■	■	■	■	■	■	■	■	■	■	■	■	■	■	•	•	•	•	•	
Potrero415 Light	•	■	•	•	■	■	■	•	■	■	■	■	■	■	■	■	■	■	■	■	■	■	■	•	•	•	•	•	
SW_1	•	•	•	•	•	•	•	•	•	•	•	•	•	•	•	•	•	•	•	•	•	•	•	•	•	•	•	•	
Train	•	■	■	■	■	■	■	■	■	■	■	■	■	■	■	■	■	■	■	■	■	■	■	•	•	•	•	•	

\*Lux Coatings, Steelcase accent paints, and PerfectMatch Custom Color are not available on 54" or 60" round tables.

# Metal/Paints Matrix

**Legend**

- = Not available
- = Available
- ▶ See specification pages for details.

Tables and Casegoods	Coalesse Metals										Custom Paint		Steelcase Paint	
	8040 Aluminum Matte Polished	8046 Polished Aluminum	9201 Chrome	9207 Polished Trivalent Chrome	9208 Etched Trivalent Chrome	9238 Brushed Nickel	9251 Brushed Aluminum	9260 Black Chrome	9261 Copper	Potrero415 Exclusives	PerfectMatch Custom Color	Accent Paints	Lux Coatings	
Ballet	•	•	•	•	•	•	•	•	•	•	•	•		
Bob	■	•	•	•	•	•	•	•	•	•	■	■		
CG_1	•	•	•	•	•	•	•	•	•	•	•	■		
E-Table 2	•	•	•	•	•	•	•	•	•	•	•	•		
Enea Lottus	•	•	•	•	•	•	•	•	•	•	■	■		
Exponents	•	•	•	•	•	•	•	•	•	•	•	•		
Exponents Mobile Display	•	•	•	•	•	•	•	•	•	•	•	•		
Lagunitas	•	•	•	•	•	•	•	•	•	•	•	■		
Lagunitas Focus Nook	•	•	•	•	•	•	•	•	•	•	•	•		
Millbrae	•	•	•	•	•	•	•	•	•	•	•	■		
Montara650*	•	•	•	•	•	•	•	•	•	•	■	■		
Potrero415	•	■	■	•	•	•	•	■	■	■	■	■		
Potrero415 Light	•	■	■	•	•	•	•	■	■	■	■	■		
SW_1	■	•	•	•	•	•	•	•	•	•	•	•		
Train	•	•	•	•	•	•	•	•	•	•	•	•		

\*Lux Coatings, Steelcase accent paints, and PerfectMatch Custom Color are not available on 54" or 60" round tables.

# Metal/Paints Palette

► See *Metal/Paints Matrix* for availability by product list, page 60.

## Coalesse Standard Powder Coat Paint—Neutral

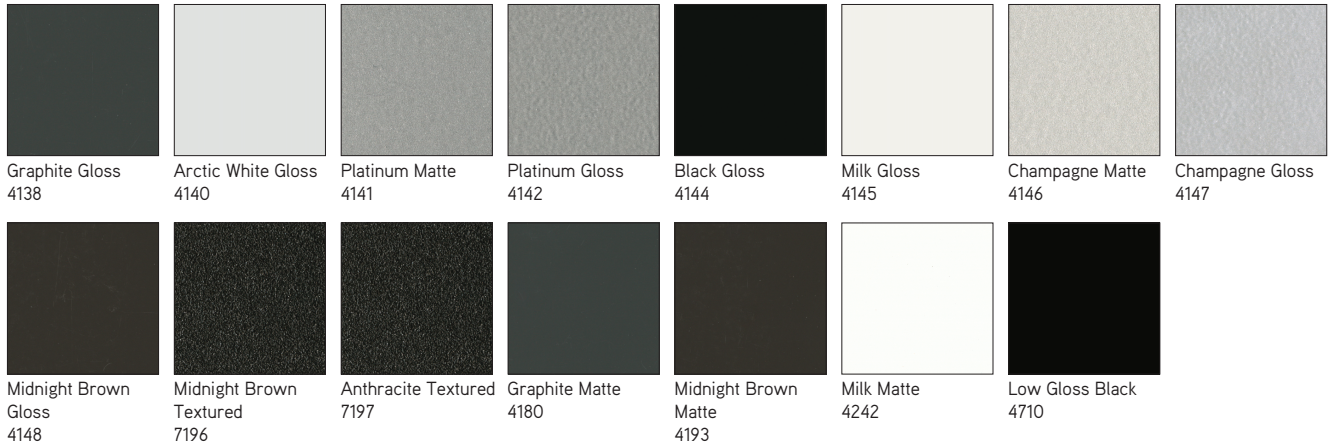

## Coalesse Standard Powder Coat Paint—Color

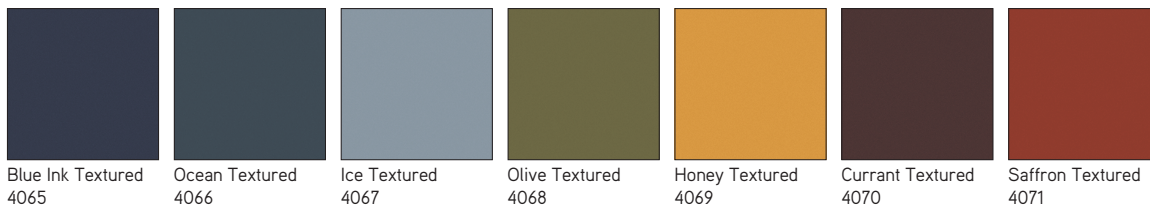

## Steelcase Accent Paints

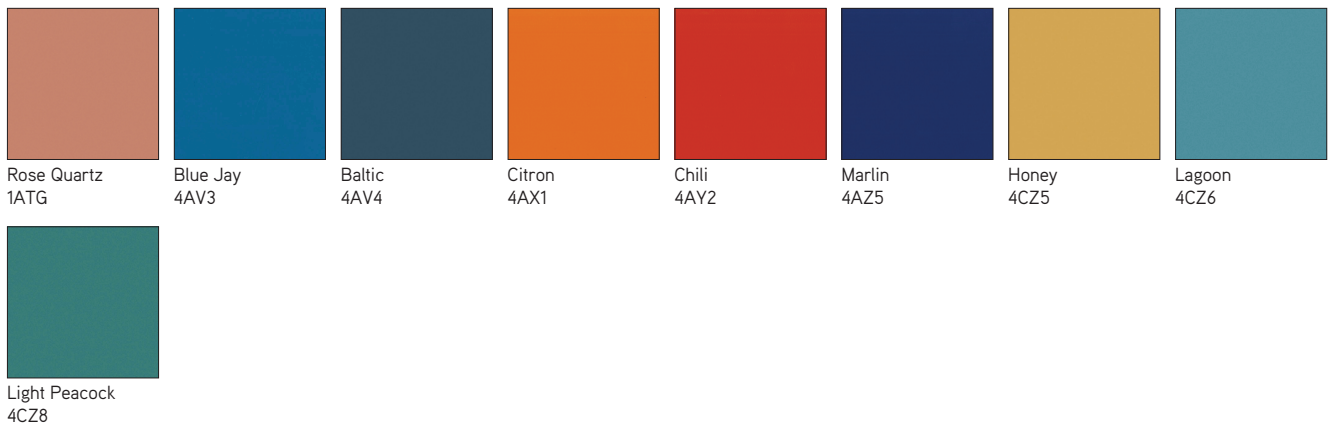

# Metal/Paints Palette

---

## Steelcase Lux Coatings

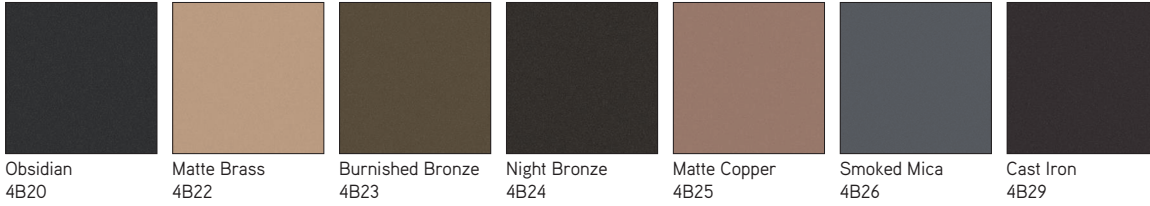

---

## Enea Paint



---

## Enea Café Wood Stool Paint (available on seat casting only)

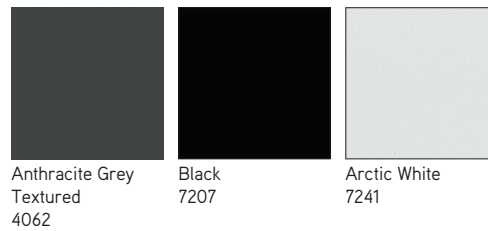

---

## Enea Lottus Exclusive Paint Finishes

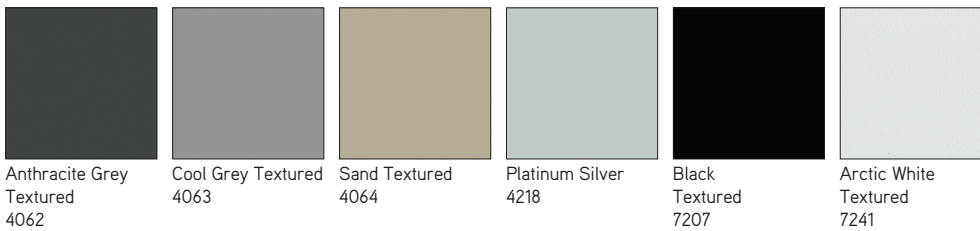

*\*Not available on Enea Lottus Tables.*

---

## Exponents Paint Colors

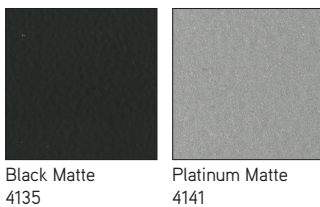

---

## Exponents Mobile Display Paint Colors



# Metal/Paints Palette *continued*

► See *Metal/Paints Matrix* for availability by product list, page 60.

## Potrero415 and Potrero415 Light Metal Leg Ring Color



Chrome  
9201

Black Chrome  
9260

Copper  
9261

## LessThanFive Essential Series Smooth Paint

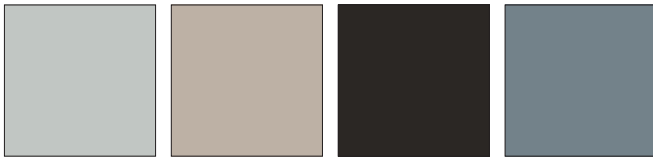

Cloud Matte  
4283

Sand Matte  
4284

Black Matte  
4285

Ice Matte  
4286

## MoreThanFive Exclusive Paint Finishes



Black Textured  
7207

## LessThanFive Smooth Paint

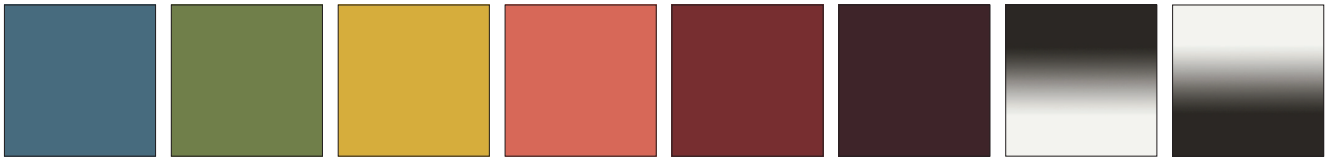

Slate Blue Matte  
4287

Fern Matte  
4288

Lemongrass Matte  
4289

Coral Matte  
4290

Poppy Matte  
4291

Currant Matte  
4292

Black Fade Matte  
4293

White Fade Matte  
4294

## LessThanFive Woven Carbon Fiber

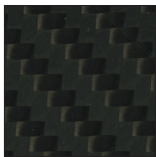

Carbon Weave  
4233\*

\*4233 Carbon Weave has a clear coat finish over woven carbon fiber.

Coalesse

# Metal/Paints Palette

# Miscellaneous

## Convex Vinyl Edge Band

Applies to:

- E-Table vinyl
- 6000 Black
- 6607 Woodrose **E**
- 6609 Smoke **E**
- 6655 Warm White
- 66WU Clay
- 66WV Chalk

## Plastic

Applies to:

- Enea
- 003 White
- 0015 Sand
- 0017 Cool Grey
- 0400 Black
- 0405 Periwinkle
- 0406 Alabaster
- 0414 Anthracite Grey

Applies to:

- Enea Altoz943, Enea café wood and Enea Lottus
- 003 White
- 0015 Sand
- 0017 Cool Grey
- 0400 Black
- 0409 Red
- 0414 Anthracite Grey
- 0421 Blue
- 0422 Blue Ink
- 0423 Ocean
- 0424 Ice
- 0425 Olive
- 0426 Honey
- 0427 Currant
- 0428 Saffron

*Tip: Not all colors available on all products. Consult the Enea plastic matrix for product line availability.*

Applies to:

- Enea café wood stool shell
- 003 White
- 0017 Cool Grey
- 0400 Black
- 0414 Anthracite Grey

Applies to:

- Exponents mobile display casters
- 6000 Black
- 6009 Arctic White

Applies to:

- Lox chairs
- 6345 Black
- 6346 White
- 6349 Greige

Applies to:

- SW\_1 grommet, barrier, wire manager, sub-structure, and lounge tablet
- Sebastopol grommet
- Sistema lounge system box table cylinder
- Potrero415 and Potrero415 Light PowerPod grommet, substructure for glass and solid surface tops
- 6000 Black
- 6052 Milk

Applies to:

- Lagunitas focus nook light grommet and Potrero415 Light power modules
- 6000 Black
- 6052 Milk
- 6D03 Graphite

Applies to:

- Grommet, spheres, flex-gangers, Mini-Port, Interport, casters, horizontal wire manager, and vertical wire manager
- Black plastic

## TAP Power Module Door Finishes

### Brushed Anodized Aluminum

Applies to:

- Host
- 8044 Black
- 8047 Silver

## Utility Bay

Applies to:

- E-Table 2
- 4137 Matte Black
- 4745 Nickel Mica
- 4746 Silver Mica
- 4747 Charcoal Mica

## Glass Doors

Applies to:

- Host credenzas
- Frosted glass

## Locks

Applies to:

- Exponents
- 9211 Nickel
- 9250 Ember Chrome

## Interior and Plinth

Applies to:

- Host credenzas
- Black Melamine

## Solid

Applies to:

- CG\_1, Exponents, Potrero415, and SW\_1 tables
- 2801 Glacier White

Applies to:

- CG\_1 leg inserts
- 2010 Black
- 2011 Midnight Black
- 2801 Glacier White

## Grommet

Applies to:

- Exponents
- 4135 Black Matte
- 4141 Platinum Black

## Power, Voice Data Modules

Applies to:

- Exponents
- 4140 Arctic White Gloss
- 4141 Black Gloss

## Soft Surface Worksurface

Applies to:

- Free Stand
- 4433 Black

## Glossy Laminate

Applies to:

- Sebastopol
- 2001 Smoky White Glossy
- 2002 Studio Gray Glossy
- 2003 Wrought Iron Glossy
- 2004 Black Pearl Glossy
- 2005 Liberty Red Glossy

## Power Module Finishes

### Brushed Anodized Aluminum

Applies to:

- Potrero415
- 8044 Black
- 8047 Silver

### Braided Cotton Power Cord

Applies to:

- MoreThanFive
- 9005 White
- 9006 Chili
- 9007 Sterling
- 9008 Honey
- 9009 Black
- 9011 Seagull
- 9014 Black/White Stripe
- 9015 White/Seagull Stripe
- 9018 Seagull/Chili Stripe
- 9019 Seagull/Honey Stripe
- 9020 Seagull/Sterling Stripe
- 9021 Seagull/White Stripe

**E** = Excluded

# Enea and Enea Lottus Plastic Matrix

Legend

- = Not available
- = Available
- ▶ See specification pages for details.

	003 White	0013 Sunset Orange	0014 Clover Green	0015 Sand	0016 Walnut Brown	0017 Cool Grey	0400 Black	0405 Periwinkle	0406 Alabaster	0409 Red	0414 Anthracite Grey	0421 Blue	0422 Blue Ink	0423 Ocean	0424 Ice	0425 Olive	0426 Honey	0427 Currant	0428 Saffron
Enea Shell	■	■	■	■	■	■	■	■	■	■	■	■	•	•	•	•	•	•	•
Enea Lottus Shell and Insert	■	•	•	■	■	■	■	•	•	•	■	•	■	■	■	■	■	■	■
Enea Café Wood Stool Seat	■	•	•	•	•	■	•	•	•	•	■	•	■	■	■	■	■	■	■
Enea Altzo943 Shell	■	•	•	■	•	■	■	•	•	•	■	•	■	■	■	■	■	■	■

# Plastic and Miscellaneous Palette

---

## E-Table Utility Bay

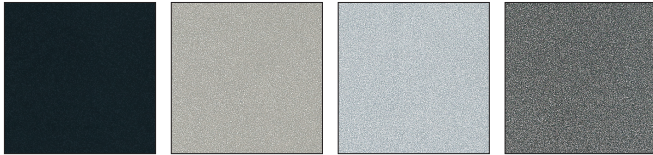

Matte Black  
4137

Nickel Mica  
4745

Silver Mica  
4746

Charcoal Mica  
4747

---

## CG\_1 - Solid Surface colors for the leg insert



Black  
2010

Midnight Brown  
2011

Glacier White  
2801

---

## Enea Plastic



White Gloss  
003

Sunset Orange  
0013

Clover Green  
0014

Sand  
0015

Walnut Brown  
0016

Cool Grey  
0017

Black  
0400

Periwinkle  
0405



Alabaster  
0406

Red  
0409

Anthracite Grey  
0414

Blue  
0421

# Plastic and Miscellaneous Palette

► See *Enea and Enea Lottus Plastic Matrix* for availability by product list, page 69.

## Enea Altzo943, Enea Cafe Wood and Enea Lottus Plastic

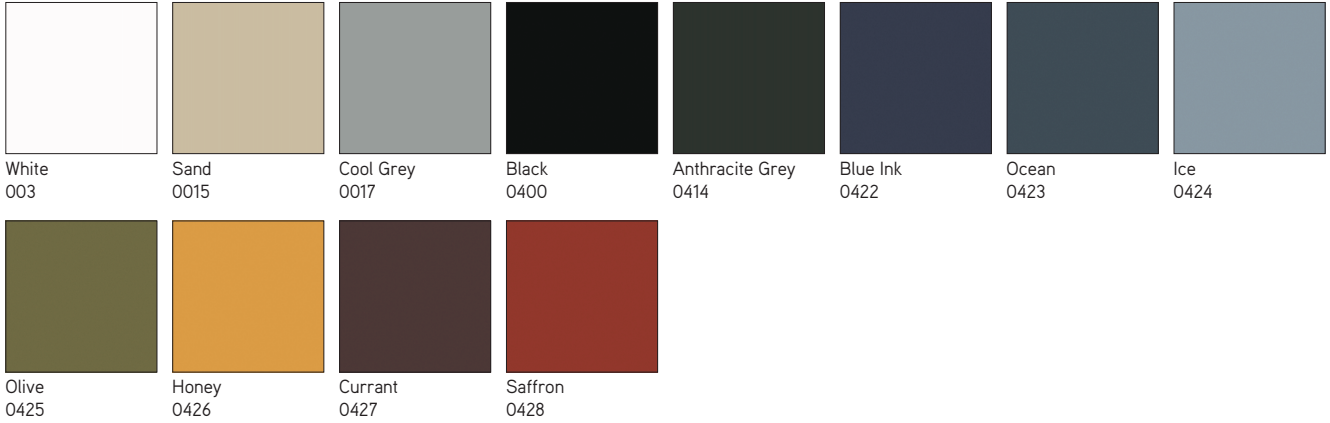

\*Available on Enea Lottus only.

*Tip: Not all colors available on all products. Consult the Enea plastic matrix for product line availability*

# Plastic and Miscellaneous Palette *continued*

---

## Hosu – Ottoman Pull Tab

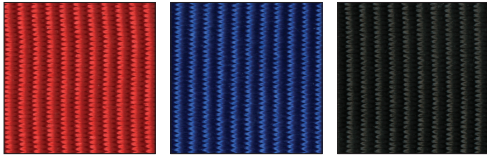

Red  
CL40

Blue  
CL41

Black  
CL42

---

## Lox Chair Plastic

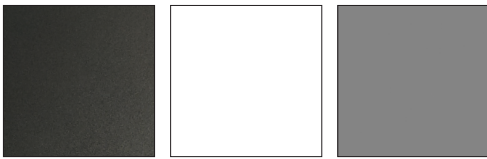

Black  
6345

White  
6346

Greige  
6349

---

## Sebastopol - Glossy laminate colors for interior surface



Smoky White  
Glossy  
2001

Studio Gray  
Glossy  
2002

Wrought Iron  
Glossy  
2003

Black Pearl  
Glossy  
2004

Liberty Red  
Glossy  
2005

---

## MoreThanFive - Braided Cotton Power Cord

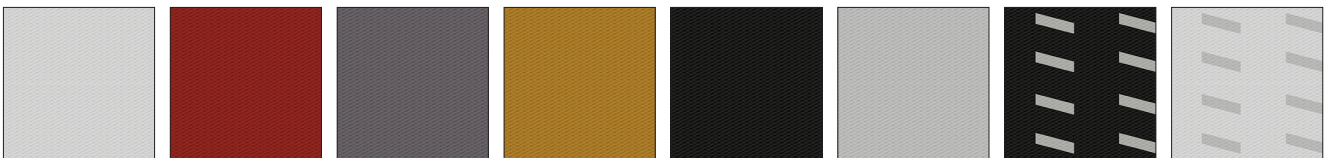

White  
9005

Chili  
9006

Sterling  
9007

Honey  
9008

Black  
9009

Seagull  
9011

Black/White  
Stripe  
9014

White/Seagull  
Stripe  
9015

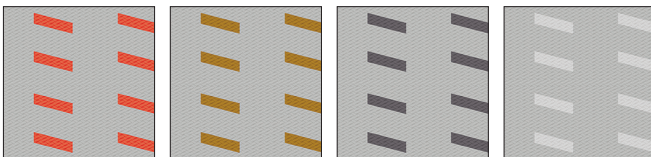

Seagull/Chili  
Stripe  
9018

Seagull/Honey  
Stripe  
9019

Seagull/Sterling  
Stripe  
9020

Seagull/White  
Stripe  
9021

# Exponents, Potrero415, Potrero415 Light, Sistema, and SW\_1 Exclusives

---

Potrero415 and Potrero415 Light PowerPod Grommet and Sub-structure, Sistema Lounge System Box Table Cylinder, Grommet, Barrier, Wire Manager, Sub-structure, and Sebastopol Grommet

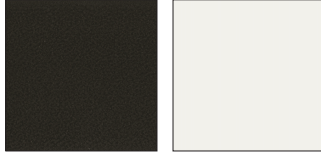

Black  
6000

Milk  
6052

---

Bob, Exponents, Potrero415, Potrero415 Light, and SW\_1 Solid Exclusive



Glacier White  
Solid Surface  
2801

---

Lagunitas Focus Nook Light Grommet and Potrero415 Light Power Modules



Black  
6000

Milk  
6052

Granite  
6D03

# Care and Maintenance

## Chrome

Use commercial cleanser and polish, according to manufacturer's directions.

## Fabric

Under normal use, clean with soft cloth dampened with water. For spots and spills, we recommend professional cleaning. For COM, refer to the specific cleaning instructions recommended by the fabric supplier.

## SW\_1 Knit:

Clean with warm water and soap. Wet sponge and wipe fabric. Household cleaners such as Windex may be used. Do NOT use cleaners containing bleach.

Laminate and solid phenolic should be cleaned with soap and water. For stubborn stains, use a non-abrasive household cleaner.

## Cleaning Laminate

### Markerboard Surface

Use dry erase markers only. Remove dry-erase markings with a markerboard eraser or soft cloth as often as possible. Change erasers, as they become dirty. Dirty erasers will leave ink residue on the surface.

For daily cleaning, or as needed, use a dry erase cleaner, or a non-abrasive household cleaner, such as glass cleaner. This may be done with a soft cloth or sponge. Dry the surface with a soft cloth prior to writing. All markings should be removed weekly.

### Caution:

- Do not use permanent markers on markerboard surfaces. In the event a permanent marker is used, removal of markings may be attempted by using dry erase cleaner, or by writing over the marking with a dry erase marker and erasing with a markerboard eraser or soft cloth.
- Do not use abrasive cleaners or solvent type cleaning solutions, such as Ketones (Acetone, MEK, etc.) lacquer thinner, nail polish remover, etc. because they may remove the finish from the markerboard surface.

### Cleaning e<sup>3</sup> CeramicSteel Markerboard Surface

- Wipe board with a clean cloth moistened by a liquid markerboard cleaner or a solution of 50% water and 50% isopropyl alcohol.
- Rinse with clear water.
- Wipe dry with a clean cloth. If your board is used daily, the cleaning should be performed at least 2-3 times a week.

More thorough cleaning may be required if writing is left on the board for more than two days.

## Markers

Use any high-quality dry erase marker.

**CAUTION!** The use of Low Odor markers may cause ghosting to occur. If Low Odor markers have been used, the surface can be completely cleaned by following the cleaning instructions above. Remember to discard eraser if used with Low Odor markers.

### Removing Permanent Marker

- Option 1:
- Write over the top of the permanent marker ink with a dry-erase marker
  - Simply erase

### Option 2:

- Moisten a clean, dry cloth with isopropyl alcohol
- Wipe the board in a circular motion to loosen marker residue
- Rinse with clear water
- Dry the board with a clean cloth
- Repeat these steps as necessary

### Installer's Instructions for Initial Cleaning at Time of Installation

NOTE: These initial cleaning instructions are shipped with every board.

- For initial cleaning, wipe your board with a clean cloth moistened by a mild, alcohol-based cleaner.
- Rinse with clear water. This step is simple, but very important.
- Wipe dry with a clean cloth.

## Leather

Under normal use, regular dusting and vacuum cleaning are all that is necessary. For spots and spills, wipe excess liquid immediately. If necessary, use lukewarm water cleaning the entire area where spot occurred and air dry. For stubborn spots or stains, use a solution of mild non-detergent soap and air dry. For butter, oil, or grease, wipe excess with dry cloth and then leave alone. The spot will dissipate into the leather. Do not apply water.

## Faux Leather

Under normal use, clean with soft cloth dampened with water. For spots and stains, use the recommended mixture of Woolite and water. Rinse with clean water and air dry.

## Granite/Glass

Under normal use, clean with Windex and soft cotton cloth.

### Powder coat finishes on chairs and table bases

should be cleaned with a liquid detergent and water. Remove stubborn stains with liquid cleanser, such as Formula 409.

### Polished Aluminum finishes on table bases and chair arms

should be cleaned with a commercial powder, liquid, or paste metal cleaner and polish. Follow the manufacturer's directions.

### Veneers and painted MDF

should be cleaned regularly with mild soap and water and dried with a soft cloth. Tip: Never use ammonia-based cleaners or wax on wood surfaces.

## Protecting Wood Surfaces

Use desk pads and coasters to help protect the finish against dents, scratches, moisture and hot and cold liquids. Do not use desk pads that have plastic backing. Use felt or leather pads on the bottoms of office equipment and accessories.

Periodically move desk accessories and other objects kept on the worksurface to ensure even aging.

Lift objects when you move them, instead of pulling or pushing them across the surface, to avoid scratching the surface. Avoid leaving vinyl binders on worksurface for long periods.

If you use a protective glass top, insert felt pads between the glass and the worksurface, to create an air space and allow the wood to breathe.

Keep your furniture away from direct sunlight. Avoid extreme temperatures and humidity. Maintain temperatures between 60 and 80 degrees Fahrenheit and humidity levels between 30 and 50 percent.

### Cleaning Wood Surfaces

Keep a supply of soft, clean, absorbent cloths handy for wiping up spills and regular dusting.

To dust, wipe with a slightly damp, soft cloth, using another soft cloth to dry. Always wipe the surface in the direction of the woodgrain.

Use a quality cleaner or flax soap formulated especially for use on wood surfaces. Do not use oils or ammonia. Dilute the cleaner as directed by the manufacturer. Dampen but do not saturate a soft cloth with the diluted cleaning solution. Wipe the surface in the direction of the woodgrain to remove dirt and fingerprints. Wipe the surface clean with a soft, dry cloth.

# Care and Maintenance

**For LessThanFive Chair**

**Finishes:**

- To clean a chair, start with water and a soft cloth, like microfiber (do not use abrasive cleaners or materials like paper towel)
- If water does not clean the chair, use a common solution, like Formula 409 or window cleaner, with a soft cloth
- For removal of indigo from denim, use isopropyl alcohol (rubbing alcohol) with a soft cloth
- To remove small scratches on the high gloss Carbon Weave chair, only wax-based paste, like SC Johnson Paste Wax or Trewax Clear Paste Wax, can be used. Waxing is not recommended for matte chairs, as this will change the matte finish of the chair.

**For Fusion Fabric:**

- Following these guidelines will help to extend the life of the fabric:
- Clean regularly with soap and water
  - Wipe up spills as soon as they occur
  - Use alcohol based cleaners, such as Fantastik® and Formula 409®
  - Sanitize using disinfectants such as: bleach (20%) water solution, hydrogen peroxide based, or quaternary based
  - For stubborn stains, wipe the stain off with isopropyl alcohol (rubbing alcohol) as soon as possible
  - Thoroughly rinse all solution residue with clean water
  - Air dry

**For Free Stand:**

- Clean the aluminum frame and worksurface frequently by applying a household cleaner (such as Formula 409 or Green Works®), and wiping dry with a clean, soft cloth.
- Avoid using Clorox disinfecting wipes, hand sanitizer, Mr. Clean Magic Erasers, or ethyl alcohol, as these can lead to severe staining, discoloration, or peeling of paint.
- Exercise caution with the worksurface in proximity to sharp objects and when setting a unit down on an abrasive surface, such as pavement or concrete. Contact with sharp objects or abrasive surfaces can cause scuffing and scratching of the work surface.

# Trademark List

™/® The following is a non-exhaustive list of trademarks and registered trademarks for products of Steelcase Inc. or one of its related corporate entities: Agree, Airtouch, Aisla, Alight, Amia, Answer, Apprise, Aspekt, Avenir, Await, B-Free, Ballet, Bassline, Bindu, Bivi, Bix, Bottomline, Brody, Buoy, Cachet, Campfire, Capa, CF Series, CG\_1, Chord, Circa, Clipper, Cobi, Collaboration, Convene, Coupe, Cura, Currency, dash, Divisio, Duo, E-Table 2, Edge Series, Elbrook, Elective Elements, Embold, Empath, Everwall, Exponents, Folio, FrameOne, Gesture, Groupwork, Host, Hosu, i2i, Jenny, Kart, Kathryn, Kick, Lagunitas, Leap, Leela, LessThanFive, LiveBack, LiveSeat, Mackinac, Marien152, Max-Stacker, media:scape, Migration, Millbrae, Mineral, Mitra, Montage, Montara650, MoreThanFive, Move, Node, Ocular, Ology, Opus, Paperflo, Passerelle, Player, Pocket, Potrero415, QiVi, Radia, Regard, Relay, Reply, Ripple, Roam, Sarto, Scoop, Sebastopol, Senti Series, Senza, Shortcut, Sidewalk, Siento, Sieste, SILQ, Soffio, Sorrel, SOTO, Steelcase Eclipse, Steelcase Flex, Steelcase Karman, Steelcase Relay, Steelcase Rise, Steelcase Series, Surround, SW\_1, Switch, Sync, Tava, Tenor, Think, Thoughtful, Thread, Together, Train, Trees, Turnstone, Umami, Underscore, V.I.A., Verb, Verge, Verlay, Victor2, Visalia, WorkValet, and X-tenz.

™/® The following are trademarks or registered trademarks of AMQ Solutions, LLC: 3F, Activ, Amobi, Bixby, Bodi, Cluvo, Concur, Embank, FL-X, Iline, Jaku, Kinex, Personality Plus, Revi, S-Series, Siya, Tektis, Tizu, Uptake, and Zilo.

™/® The following are trademarks or registered trademarks of Orangebox Ltd., Cardiff, UK: Air3, Aspect, Avi, Away from the Desk, Border, Campers & Dens, Coppice, Cubb, Kirm, On the QT, Ramsey, Skomer, Sully, Track-B, and Vale.

™/® The following are trademarks or registered trademarks of Viccarbe Habitat, S.L.: Aleta, Cambio, Designed in The Sun, Foro, Funda, Holy Day, Kelly, Last Minute, Noha, Savina, Sistema, Sistema, Viable, and Wrapp.

® The following are registered brands of Steelcase Inc. and its family of companies: Steelcase, AMQ, Coalesse, Designtex, Halcon, Orangebox, Smith System, and Viccarbe.

® The following registered trademarks are under license from AWI Licensing Company, Dover, DE: SoundScapes, DuraBrite, BioBlock, and Armstrong.

® The following registered trademarks are under license from Byrne Electrical, Rockford, MI: Interport, Mini-Port, Axil Z, and Ellora.

® The following is a registered trademark of DuPont, Wilmington, DE: Corian.

® The following is a registered trademark of Genlyte Thomas Company, Louisville, KY: Lightolier.

® The following is a registered trademark of Hilti Corporation, FL-9494 Schaan, Principality of Liechtenstein: Hilti.

® The following is a registered trademark of Leviton Manufacturing Company, Little Neck, NY: Decora.

® The following is a registered trademark of Mechanical Plastics Corp, Elmsford, NY: Toggler.

® The following is a registered trademark of Microsoft Corporation, Redmond, WA: Microsoft.

® The following are registered trademarks of Orangebox Ltd., Cardiff, UK: Orangebox.

® The following is a registered trademark of Panduit Corporation, Lockport, IL: Panduit.

® The following is a registered trademark of Trav (Press), Cuneo, Italy: Assisa.

® The following is a registered trademark of Virtual Ink, Boston, MA: mimioActive.

® The following registered trademarks are under license from Wilkhahn Furniture Products: Avera, Senzo, Versal, and Wilkhahn FS.

® The following are registered trademarks of Polyvision Corp: Flow, Motif, Polyvision, Sans, and Serif.

® The following is a registered trademark of Wilsonart International, Temple, TX: Chemsurf.

® The following is a registered trademark of Wiremold, West Hartford, CT: Wiremold.

® The following is a registered trademark of EMU Group S.P.A., Perugia, Italy: EMU.

® The following is a registered trademark of Security People, Inc.: Digilock.

® The following are registered trademarks of Natural Capital Partners Europe Limited: CarbonNeutral and the CarbonNeutral Certified logo.

™ The following is a trademark of Microsoft Corporation, Redmond, WA: Windows.

™ The following is a trademark of Rodman Industries, Inc., Oconomowoc, WI: ResinCore1.

™ The following is a trademark of Ultrafabrics, LLC, Elmsford, NY: Ultraleather.

™ The following trademarks are under license from Wilkhahn Furniture products: Cana, Linus, Logon, Picto, Range, Stitz, Thema, Timetable, and Tubis.

™ The following trademarks are under license from Walter Knoll: Andoo, Bob, Lazlo, Lox, Ribbon, and Together.

™ The following trademarks are under license from PP Mobler: Bar and Flag Halyard.

™ The following trademarks are under license from Carl Hansen: Elbow, Paddle, Shell, Wing, and Wishbone.

™ The following trademarks are under license from Cambridge Sound Management, LLC Cambridge, MA: QtPro Soundmasking, Qt Quiet Technology, and Sonet Qt.

™ The following is a trademark of Electri-Cable Assemblies, Shelton, CT: Interact.

™ The following is a trademark of Clestra Hauserman: IRYS.

™ The following is a trademark of Wiesner-Hager Möbel GmbH: Nooi.

™ The following are trademarks of Polyvision: Accord, a3, e3, Boundri, and Nota.

™ The following is a trademark of Bostock Company, Inc: SnapCab.

™ The following is a trademark of Williams-Sonoma, Inc: West Elm.

™ The following is a trademark of Elena Marquina Testor: nanimarquina.

™ The following is a trademark of Forbo International SA: Forbo.

Trademarks used herein are the property of Steelcase Inc. or their respective owners.