

METALWORKS™ Linear – Classics

Standard Wall Planks
smooth texture



FAST134
Select Items Ship Fast
armstrongceilings.com/fast134



MetalWorks™ Linear – Classics wall system in Sequels™ La Jolla Oak

CAD/Revit® drawings at:
armstrongceilings.com/cadrevit

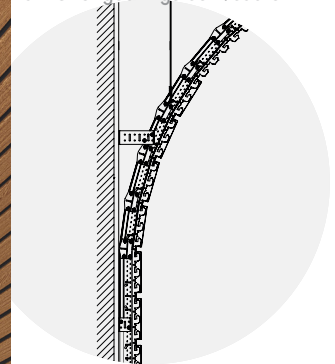

plus capabilities
to do more



armstrongceilings.com/capabilities
See more photos at:
armstrongceilings.com/photogallery

Durable, metal panels in more widths for a variety of flexible and unique acoustical interior solutions.

KEY SELECTION ATTRIBUTES

- Four new Sequels™ pre-coat, wood-look finishes are part of the Sustain™ portfolio and FAST134 program
- MetalWorks™ FASTPeel™ panels feature an easier-to-remove protective film
- Universal suspension system enables easy installation and a clean finished visual
- Nominal 2", 4", 6", 8", 10", and 12" wide panels, including nominal 1" reveal (contact ASQuote for custom capabilities at asquote@armstrongceilings.com)
- Available in 17 Effects™ wood-look finishes
- MetalWorks™ Linear – Classics panels are part of the Sustain™ portfolio, and meet the most stringent industry sustainability compliance standards today
- Mix and match widths for a striated visual
- CleanAssure™ family of products – includes disinfectable panels, suspension systems, and trim
- Select products included in the FAST134 program – ready to ship in 4 weeks or less
- Install on wall horizontally
- Create 90° angled or curved ceiling-to-wall transitions
- Acoustical options with microperforated panels
- Fast and easy installation



This product can be adjusted to comply with Build America, Buy America (BABA) requirements. Modifications to pricing and lead times may apply. Contact your local sales representative for additional information.

METALWORKS™ Linear – Classics

Standard Wall Planks
smooth texture



RECYCLED
CONTENT

UP TO
35%

LEED V5

COMMON MATERIALS FRAMEWORK		Climate Health	EPD
Human Health	Declare Label HPD	Ecosystem Health	EPD
	3rd Party CDPH	Circular Economy	✓
OCCUPANT EXPERIENCE		Acoustics	✓



MetalWorks™ Linear – Classics Ceiling System with 4" Perforated and Unperforated panels in White

STANDARD COLORS & FINISHES

Painted

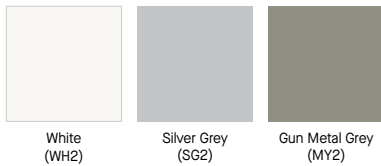

Sequels™ Pre-coated Coil, Fast Lead Time



Effects™ Classic Dye-Sublimation

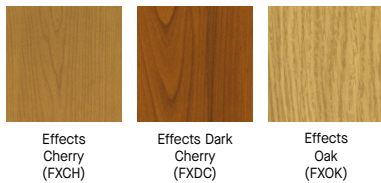

Effects™ Bold Dye-Sublimation



Effects™ Subtle Dye-Sublimation

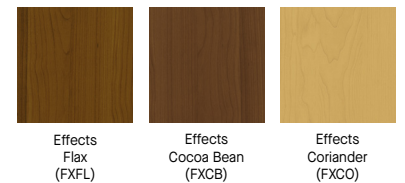
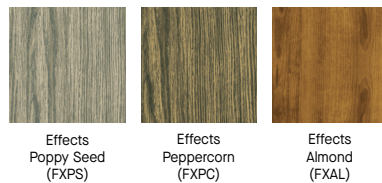
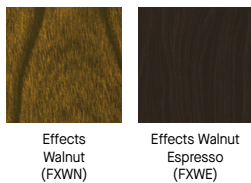
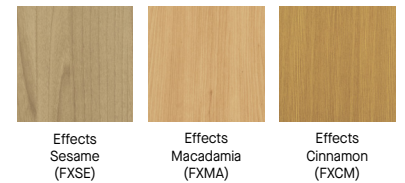

Due to printing limitations, shade may vary from actual product.

CUSTOM COLORS & FINISHES



For custom options contact ASQuote,
ASQuote@armstrongceilings.com

PERFORATION OPTIONS (1:2 scale shown)

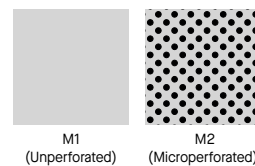

METALWORKS™ Linear – Classics

Standard Wall Planks
smooth texture



Declare.

RECYCLED CONTENT

UP TO
35%

LEED V5

COMMON MATERIALS FRAMEWORK		Climate Health	EPD
Human Health	Declare Label HPD	Ecosystem Health	EPD
	3rd Party CDPH	Circular Economy	✓
OCCUPANT EXPERIENCE		Acoustics	✓

VISUAL SELECTION

Item No. ♦	Description	Dimensions Nominal W × L × H (Inches)	Custom Sizes Available
METALWORKS™ Linear – Classics Planks			
8120_ _ _ _	2" Unperforated	96 × 2 × 5/8"	
5490_ _ _ _	4" Unperforated	96 × 4 × 5/8"	
Interior Only			
7160_ _ _ _	6" Unperforated	96 × 6 × 5/8"	
5491_ _ _ _	8" Unperforated	96 × 8 × 5/8"	
8122_ _ _ _	10" Unperforated	96 × 10 × 5/8"	
5570_ _ _ _	12" Unperforated	96 × 12 × 5/8"	
METALWORKS Linear – Classics Planks			
8121_ _ _ _	2" Microperforated (with plain border and acoustical fleece)	96 × 2 × 5/8"	
Interior Only			
5492_ _ _ _	4" Microperforated (with plain border and acoustical fleece)	96 × 4 × 5/8"	
7161_ _ _ _	6" Microperforated (with plain border and acoustical fleece)	96 × 6 × 5/8"	
5493_ _ _ _	8" Microperforated (with plain border and acoustical fleece)	96 × 8 × 5/8"	
8123_ _ _ _	10" Microperforated (with plain border and acoustical fleece)	96 × 10 × 5/8"	
5571_ _ _ _	12" Microperforated (with plain border and acoustical fleece)	96 × 12 × 5/8"	

PERFORMANCE

Dots represent high level of performance.

Fire Performance	Light Reflect (White only)	CleanAssure™ Disinfectable Panels			DURABILITY					Acoustics
		Fog	Spray	Wipe	Wash	Scrub	Impact	Scratch	Soil	
Class A	0.73	*	*	*	*	*	*	*	*	N/A
Class A	0.73	*	*	*	*	*	*	*	*	N/A
Class A	0.73	*	*	*	*	*	*	*	*	N/A
Class A	0.73	*	*	*	*	*	*	*	*	N/A
Class A	0.73	*	*	*	*	*	*	*	*	N/A
Class A	0.73	*	*	*	*	*	*	*	*	N/A
Class A	N/A	*	*	*	*	*	*	*	*	N/A
Class A	N/A	*	*	*	*	*	*	*	*	0.70 0.85*
Class A	N/A	*	*	*	*	*	*	*	*	0.70 0.85*
Class A	N/A	*	*	*	*	*	*	*	*	0.70 0.85*
Class A	N/A	*	*	*	*	*	*	*	*	0.70 0.85*
Class A	N/A	*	*	*	*	*	*	*	*	0.70 0.85*

FAST
4 WEEKS
or Less

FAST134 program items ready to ship from manufacturer in 4 weeks or less.
Up-to-date lead times and product options (sizes and colors) at armstrongceilings.com/fast134

♦ When specifying or ordering, include the appropriate 3- or 4-letter color suffix (e.g., 5492 W H 2, 5570 E X C H 2).
When specifying or ordering exterior finishes, place a "2" after the item color suffix (e.g., 5491 E X C H 2).
NOTE: Exterior finishes are only available on M1 planks.
* NRC 0.85 with optional fiberglass infill.
** Sequels™ Finishes are for interior use only

INSTALLATION DETAILS – WALLS

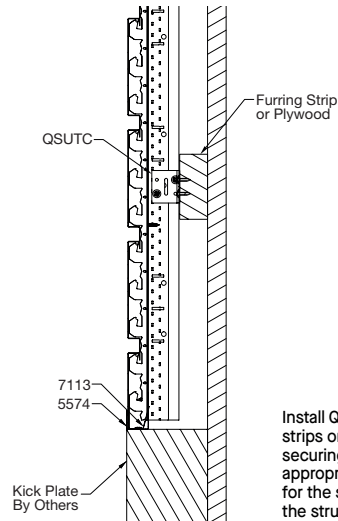
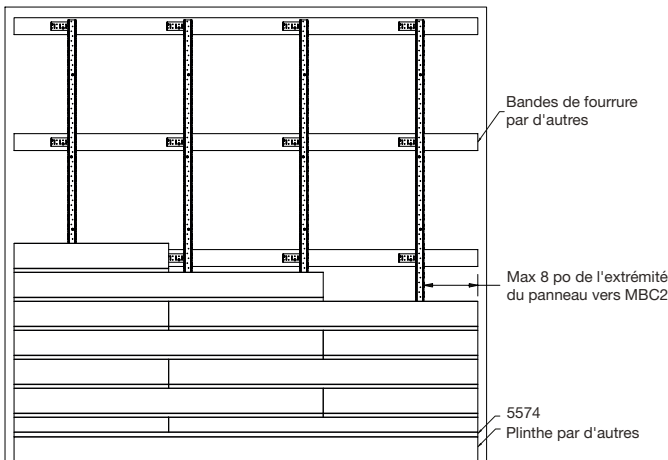

Install QSUTC to furring strips or 5/8" plywood, securing them with appropriate fasteners for the substrate to the structure

Main Beam Carrier 2 (MBC2) installs on the wall perpendicular to desired plank length direction

TechLine 877 276-7876
armstrongceilings.com/metalworkslinear

Armstrong®
World Industries



METALWORKS™ Linear – Classics

Standard Wall Planks
smooth texture



Declare.

RECYCLED CONTENT

UP TO
35%

LEED V5

COMMON MATERIALS FRAMEWORK		Climate Health	EPD
Human Health	Declare Label HPD	Ecosystem Health	EPD
	3rd Party CDPH	Circular Economy	✓
OCCUPANT EXPERIENCE		Acoustics	✓

SUSPENSION SYSTEM & ACCESSORIES

	Item No. ♦	Description	Dimensions (Inches) Nominal W × L × H	Color	Pieces/Carton
Suspension Systems Interior Only	7177	FrameAll® Main Beam Carrier Assembly – G90 Mill Finish	144 × 1-3/4 × 2-3/4"	N/A	10
	XL8945P	4' FrameAll Drywall Cross Tee – Interior Only	48 × 1-1/2 × 1-1/2"	N/A	36
	XL8945G90	4' FrameAll Drywall Cross Tee	48 × 1-1/2 × 1-1/2"	N/A	36
	XL7936G90	3' FrameAll Drywall Cross Tee – Exterior	36 × 1-1/2 × 1-1/2"	N/A	36
	XL8926G90	2' FrameAll Drywall I Cross Tee – Exterior	24 × 1-1/2 × 1-1/2"	N/A	36
Wall-to-Wall Installations	8161	Pressure Spring	3/4 × 3/4 × 1-1/8"	N/A	50
	BERC2	Beam End Retaining Clip	N/A	N/A	200
	5574_ _ _ _ _	Carrier Molding Molding – Exterior Available	120 × 1 × 1"	WH, SG, MY, BL and all Effects Wood Looks	10
	7800_ _ _ _ _	Hemmed Angle Molding	144 × 7/8 × 7/8"	WH, BL	30
	HD7801G90_ _	10' Hemmed Angle Molding – Exterior	120 × 7/8 × 7/8"	N/A	30
Other Accessories	7237	Cut Plank Support Bracket	2-1/2 × 2-1/2 × 1-1/4"	N/A	50
	5494	Contrast Filler Strip	96 × 1-1/4 × 1/16"	50	Black

* Items with the same finish name will coordinate but may not be an exact color match.

♦ When specifying or ordering, include the appropriate 4- or 5-letter color suffix (e.g., 5583 F X C H, 5583 F X C H 2).

NOTE: Due to the non-standard suspension system of this product, call TechLine at 1 877 276 7876 to place an order.

ACCESSORIES

	Item No. ♦	Description	Pieces/ Carton	Finish Selection
Splice Plates	8159	2" Panel Splice	50	N/A
	5495	4" Panel Splice	50	N/A
	7163	6" Panel Splice	50	N/A
	5496	8" Panel Splice	50	N/A
End Caps	8138_ _ _ _ _	2" End Cap	50	WH, SG, MY, BL2 and all Effects Wood Looks
	5581_ _ _ _ _	4" End Cap	50	WH, SG, MY, BL2 and all Effects Wood Looks
	7162_ _ _ _ _	6" End Cap	50	WH, SG, MY, BL2 and all Effects Wood Looks
	5582_ _ _ _ _	8" End Cap	50	WH, SG, MY, BL2 and all Effects Wood Looks
	8139_ _ _ _ _	10" End Cap	50	WH, SG, MY, BL2 and all Effects Wood Looks
	5583_ _ _ _ _	12" End Cap	50	WH, SG, MY, BL2 and all Effects Wood Looks

♦ When specifying or ordering, include the appropriate 4- or 5-letter color suffix (e.g., 5583 F X C H, 5583 F X C H 2).

PHYSICAL DATA

Material

Electrogalvanized Steel – thickness 0.028"

Surface Finish

White, Silver Grey, Gun Metal Grey: Powder Coated Effects™; Powder Coated, dye sublimation post-production Sequels™; Pre-coated coil.
Natural Reflections finishes and other colors are available as custom. Contact ASQuote@armstrongceilings.

Edge Detail

Square with extended flange. To create contrast visual, flange is covered with 1-1/4" Black Contrast Filler Strip Item 5494.

Fire Performance

Class A: ASTM E84 and CAN/ULC S102.
Flame Spread Index 25 or less. Smoke Developed Index 50 or less.

ASTM E1264 Classification

Fire Class – Class A
Unperforated – Type XX, Pattern G
Perforated – Type XX, Pattern C

Design Considerations

While we strive to ensure exact color matches, various factors such as differences in materials and painting processes can affect how colors appear on ceiling and wall

panels, suspension systems, and trim products. Due to these and other differences, items with the same finish name will coordinate but may not be an exact color match.

Installation Considerations

Panels with certain product finishes, e.g., Effects™ and Natural Reflections, are not MetalWorks™ FASTPeel™ panels and will be protected by other means for packaging and handling purposes.

Seismic Restraint

MetalWorks Linear panels have been engineered, tested, and approved for application in all seismic areas when installed per Armstrong Ceilings installation instructions.

Wind Uplift Performance

All panels tested for wind uplift Classes 30, 60, and 90. Specific installation recommendations to meet these wind classes are available. There is no acoustical fleece on exterior panels. For more information, contact TechLine at 1 877 276 7876.

FAST134 Program Considerations

Size of Job Matters: Big jobs, over 2500 SF or 50 pieces for shapes/vertical elements will have longer lead times.

Location Matters: Transit time not included. We are ready to ship in 1 week on FAST1 items. However, transit to the states west of Wyoming may add time.

Distributor Truck Schedule Matters: We rely on distribution to help move products around the country. When speed matters, work with your local distributor to ensure FAST134 service.

Stock vs Made-to-Order Matters: FAST3 & FAST4 items are made-to-order and will ship direct to distributor. FAST1 (stocked items) will go through distribution and depend on distributor truck schedules.

Cleaning and Disinfecting

Cleaning and CDC approved disinfecting options available on armstrongceilings.com/cleaning

Warranty

Details at armstrongceilings.com/warranty

Weight; Square Feet/Carton

8120 – 1.61 lbs/SF; 24 pcs/ctn or 192 LF/ctn; 32.00 SF/ctn
5491 – 1.61 lbs/SF; 16 pcs/ctn or 128 LF/ctn; 42.66 SF/ctn
7160 – 1.61 lbs/SF; 12 pcs/ctn or 96 LF/ctn; 48.00 SF/ctn
5491 – 1.61 lbs/SF; 10 pcs/ctn or 80 LF/ctn; 53.33 SF/ctn
8122 – 1.61 lbs/SF; 8 pcs/ctn or 64 LF/ctn; 53.33 SF/ctn
5570 – 1.61 lbs/SF; 6 pcs/ctn or 48 LF/ctn; 48.00 SF/ctn
8121 – 1.61 lbs/SF; 24 pcs/ctn or 192 LF/ctn; 32 SF/ctn
5492 – 1.61 lbs/SF; 16 pcs/ctn or 128 LF/ctn; 42.66 SF/ctn
7161 – 1.61 lbs/SF; 12 pcs/ctn or 96 LF/ctn; 48.00 SF/ctn
5493 – 1.61 lbs/SF; 10 pcs/ctn or 80 LF/ctn; 53.33 SF/ctn
8123 – 1.61 lbs/SF; 8 pcs/ctn or 64 LF/ctn; 53.33 SF/ctn
5571 – 1.61 lbs/SF; 6 pcs/ctn or 48 LF/ctn; 48.00 SF/ctn

