

DARRAN®

Occasional Tables

Effective May 2026



Effective July 14th 2025 a tariff surcharge of 4% will be charged on all occasional table orders.

Refine your space. Design your culture.

Price List Revisions

Date	Page	Modification
05.01.2026		Zum table dropped
05.05.2026	12	Adjustment made to Around Town glass top pricing



Price List Index

- Statement of Line 4
- Finishes 5
- Finish Matrix 9
- Edges | Pulls 11
- Around Town Tables 12
- Cell Tables 13
- Fluted Post Tables 14
- Grove Tables 16
- Jackson Tables 19
- Trade Street Tables 22
- Power & Data 26

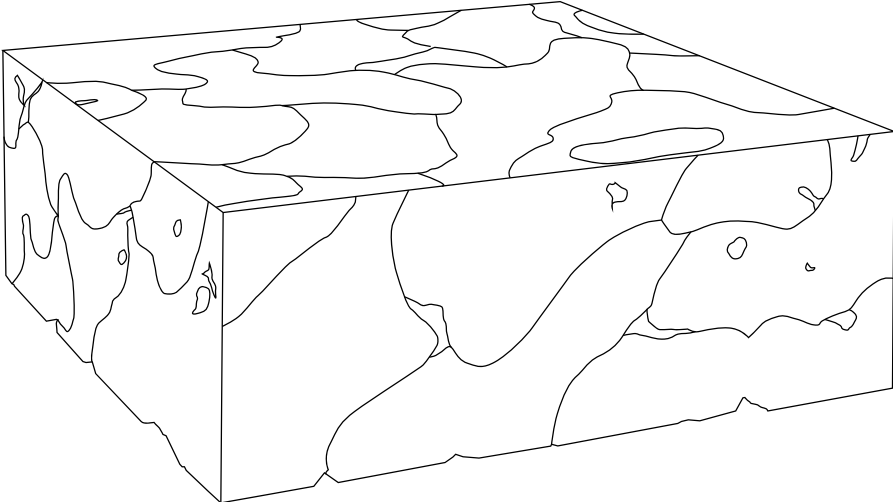

Statement of Line

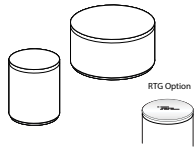

Page 12
Around Town Tables
Plinthe Table

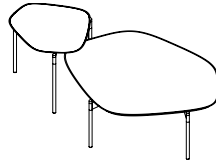

Page 13
Cell Tables
Cocktail Table And End
Table



Page 14
Fluted Post Tables
Cocktail Table



Page 15
Fluted Post Tables
Console Table



Page 16
Grove Small Round Table
Acacia Stool/Round Table



Page 17
Grove Square Table
Acacia Stool/Square Table



Page 18
Teak Square
Cocktail/Coffee/Side Table

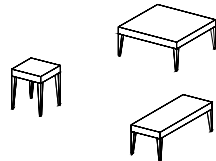

Page 19
Jackson Tables
Square End Table/Cocktail
Table

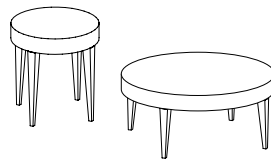

Page 20
Jackson Tables
Round Table

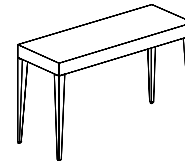

Page 21
Jackson Tables
Console Tables



Page 22
Trade Street Tables
Square Table



Page 23
Trade Street Tables
Round Table



Page 24
Trade Street Tables
Cocktail Table

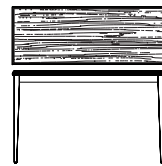

Page 25
Trade Street Tables
Console Table

Finish & Powdercoating Information

Veneer provides the warmth, richness, and authenticity of real wood, making it a premium choice for high-end furniture and architectural interiors. Because it is made from thin slices of actual wood, it can be stained, finished, or even lightly refinished over time, offering design flexibility while using less solid wood overall.

WellTech finish delivers a superior furniture coating with exceptional performance that can withstand stringent cleaning agents and possesses unparalleled durability, allowing DARRAN to provide lasting sustainable products to our customers.

HPL (High-Pressure Laminate) is known for its exceptional durability, making it ideal for heavy-use environments such as countertops, desks, and work surfaces. It offers strong resistance to scratches, impact, heat, and chemicals, and comes in an extensive range of designs and textures—including wood looks, solids, and specialty patterns. The manufacturing process ensures consistent, predictable results, giving designers reliability along with performance.

Powdercoating provides a durable, long-lasting finish that resists chipping, scratching, corrosion, and fading, even in demanding environments. The process creates a uniform, high-quality surface with excellent color consistency, enhancing both performance and aesthetics. Because it produces minimal waste and requires no solvents, powdercoating is also an environmentally responsible choice that supports sustainable manufacturing.



Finishes: Tables

Note: Finish availability differs on each product. Please see Finish Matrix pages for specific availability.

Veneer Finishes

5% Matte Sheen



WAF Narvik



WCM Clear Maple



WLF Lofty Oak



WFF Fawn Cypress



WNF Natural Oak

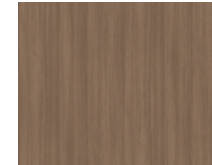

WEF Neo

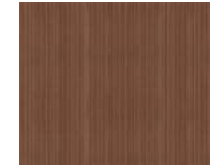

WOW Clear Walnut



WGW Gunstock Walnut



WMF Mocha Oak

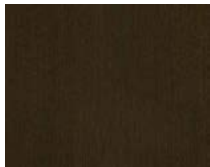

WBW Henna Walnut



WEC Ebony Cherry



WSW Smokey Walnut

25% Satin Sheen

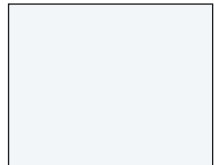

WWP Designer White



WBC Biltmore Cherry



WAC Amber Cherry



WNW Natural Walnut



WEW Executive Walnut



WIC Crimson Cherry

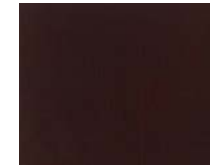

WOC Koko Cherry

**Sheen as indicated unless one of the following options is specified: \$95 upcharge | \$25 Change sheen from 5 to 25 | \$5 Change sheen from 25 to 5

Finishes: Tables

Note: Finish availability differs on each product. Please see Finish Matrix pages for specific availability.

Premium Veneer Finishes

5% Matte Sheen



WRF Aureon



WLO Lofty Oak



TBCO Baby's Cheek



WFO Fawn Cypress



WNO Natural Oak



WQF Quarry



WDF Cortado

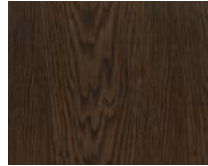

WOF Loam



WMO Mocha Oak



WPF Espresso

25% Satin Sheen

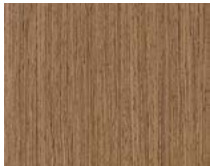

TOBW Organic Brown



TBSW Brown Sugar



TSTV Studio Teak



TSLV Skyline Walnut

**Sheen as indicated unless one of the following options is specified: \$95 upcharge | \$25 Change sheen from 5 to 25 | \$5 Change sheen from 25 to 5

Finishes

Note: Finish availability differs on each product. Please see Finish Matrix pages for specific availability.

High Pressure Laminates

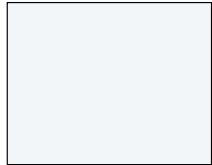

GWL Designer White



GNA Narvik



LW02 Fawn Cypress

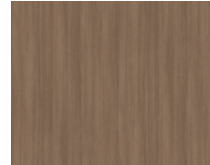

LW01 Neo



GSTV Studio Teak



GSLV Skyline Walnut



GBC Biltmore Cherry



GAC Amber Cherry



GNW Natural Walnut



GEW Executive Walnut

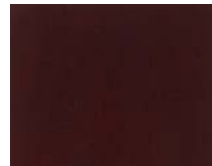

GIC Crimson Cherry

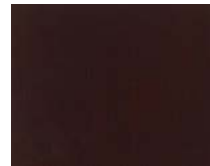

GOC KoKo Cherry



GEC Ebony

Powdercoat Finishes

Standard

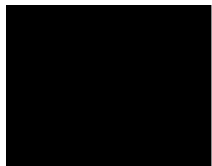

MFB Black

Premium

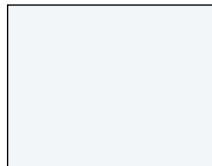

MFW White



MFS Silver

Finish Matrix

	Around Town	Cell	Fluted Post	Jackson	Trade Street
Amber Cherry 		W G	W G	W G	W G
Aureon 		P			
Baby's Cheek 		P			
Biltmore Cherry 		W G	W G	W G	W G
Brown Sugar 		P			
Clear Maple 		W		W	W
Clear Walnut 	W	W			
Cortado 		P			
Crimson Cherry 		W G	W G	W G	W G
Designer White 		W G			
Ebony Cherry 		W G		W	
Espresso 		P			
Executive Walnut 	W G	W G	W G	W G	W G
Fawn Cypress 	W G	W P G			
Gunstock Walnut 	W	W	W	W	W
Henna Walnut 	W	W	W	W	W
KoKo Cherry 		W G	W G	W G	W G

FINISH CODES

W - Available as a standard veneer
P - Available as a premium veneer
G - Available as a high pressure laminate (HPL)

Finish Matrix

		Around Town	Cell	Fluted Post	Jackson	Trade Street
Loam			P			
Lofty Oak		W	W P			
Mocha Oak		W	W P			
Narvik		W	W G			
Natural Oak		W	W P			
Natural Walnut		W G	W G	W G	W G	W G
Neo		W G	W G			
Organic Brown			P			
Quarry			P			
Skyline Walnut			P G			
Smokey Walnut		W	W	W	W	W
Studio Teak			P G			

FINISH CODES

W - Available as a standard veneer

P - Available as a premium veneer

G - Available as a high pressure laminate (HPL)

Edges | Pulls

Edges

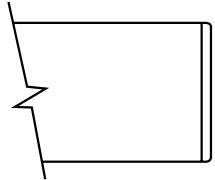

Flat

"W" 2mm solid hardwood band
"P" 2mm solid hardwood band
Available on: Trade Street

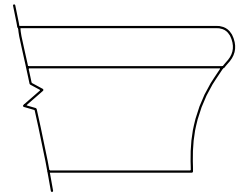

Knife

Available on: Trade Street

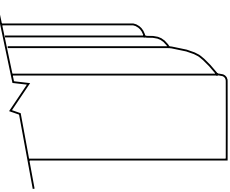

Traditional

Available on: Fluted Post

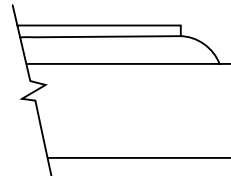

Classic

2mm solid hardwood band
Available on: Fluted Post
Trade Street

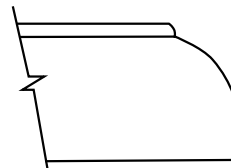

Waterfall

Available on: Trade Street

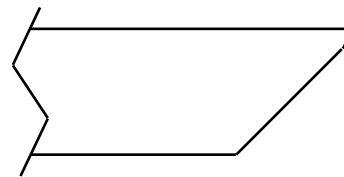

Lamina | Cell

Available on: Cell

Pulls

Factory Installed

Available on: Fluted Post console tables

PL-5 Antique Brass
PL-50 Brushed Pewter



PL-4 Antique Brass



Occasional

Around Town Tables | Plinthe Table

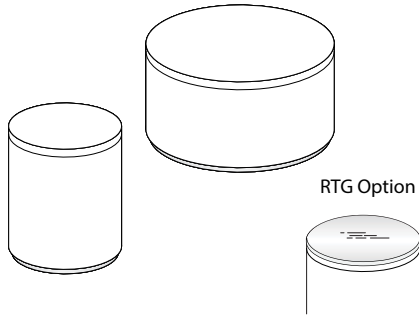

Product features

- 1" Top with 3mm wood edge
- Plinthe base with black accent
- Glides

Notes

- Contact Customer Service for Stone/Solid Surface accent tops.
- Finish availability differs on each product. Please see Finish Matrix page for finishes available on Around Town tables.

Options

Frosted Glass Top

- RTG28: 35" dia Frosted glass top - \$1267
- RTG26: 29" dia Frosted glass top - \$952
- RTG24: 23" dia Frosted glass top - \$690
- RTG22: 17" dia Frosted glass top - \$480

Clear Glass Top

- RTG18: 35" dia Clear glass top - \$1220
- RTG16: 29" dia Clear glass top - \$920
- RTG14: 23" dia Clear glass top - \$669
- RTG12: 17" dia Clear glass top - \$470

STEP 1: Select Model

See table for sizing & pricing

STEP 2: Select Finish

[Click to view options](#)

MODEL	w" x d" x h"	Wt.	Standard Veneer Top Standard Veneer	Premium Veneer Top Premium Veneer Chassis	HPL Top Veneer Chassis	TFL Top TFL Chassis
Cocktail Table	36 dia x 16	70	DBO3636RT372W 3035	"P" Option N/A	DBO3636RT372G 3035	"M" Option N/A
	30 dia x 16	55	DBO3030RT372W 2807	"P" Option N/A	DBO3030RT372G 2807	"M" Option N/A
End Table	24 dia x 22	45	DBO2424RT372W 2044	"P" Option N/A	DBO2424RT372G 2044	"M" Option N/A
	18 dia x 22	40	DBO1818RT372W 1963	"P" Option N/A	DBO1818RT372G 1963	"M" Option N/A

[Click to view Statement of Line](#)

SIN: 33721

Occasional

Cell Tables | Cocktail Table And End Table

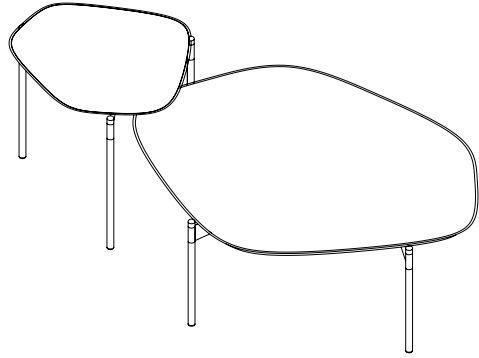

Product features

- 1" Thick top
- Black Metal Finish standard
- Shipped KD

Notes

- Finish availability differs on each product. Please see Finish Matrix page for finishes available on Cell tables.

Options

Premium Metal Finishes

- Legs standard in MFB Black
- Premium powdercoat options. End table - \$80 upcharge. Cocktail table - \$100 upcharge.
- Premium options: MFW White, MFS Silver

STEP 1: Select Model

See table for sizing & pricing

STEP 2: Select Finish

[Click to view options](#)

STEP 3: Select Edge

[Click to view options](#)

MODEL	w" x d" x h"	Wt.	Standard Veneer Top Black Metal Base		Premium Veneer Top Black Metal Base		HPL Top Black Metal Base		TFL Top Black Metal Base
End Table	23 x 19 x 17.75	60	CEL2319MT366W	1468	CEL2319MT366P	1615	CEL2319MT366G	1468	"M" Option N/A
Cocktail Table	42 x 32 x 14.25	85	CEL4232MT369W	2039	CEL4232MT369P	2243	CEL4232MT369G	2039	"M" Option N/A

[Click to view Statement of Line](#)

SIN: 33721

Occasional

Fluted Post Tables | Cocktail Table

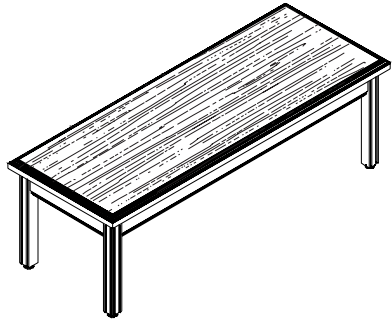

Product features

- 1-5/16" Thick top
- Floor levelers (adjustable 1/2")
- Solid hardwood base legs

Notes

- Tables are available in Cherry and Walnut Finishes
- Finish availability differs on each product. Please see Finish Matrix page for finishes available on Fluted Post tables.

STEP 1: Select Model
See table for sizing & pricing

STEP 2: Select Finish
[Click to view options](#)

STEP 3: Select Edge
[Click to view options](#)

MODEL	w" x d" x h"	Wt.	Standard Veneer Top Standard Hardwood Base	Premium Veneer Top Premium Hardwood Base	HPL Top Standard Hardwood Base	TFL Top Standard Hardwood Base
Cocktail Table	18 x 48 x 16	50	DBO1848FT351W 1815	"P" Option N/A	DBO1848FT351G 1815	"M" Option N/A
	36 x 36 x 16	60	DBO3636FT351W 1859	"P" Option N/A	DBO3636FT351G 1859	"M" Option N/A
End Table	24 x 24 x 20	40	DBO2424FT351W 1488	"P" Option N/A	DBO2424FT351G 1488	"M" Option N/A
	18 x 18 x 20	30	DBO1818FT351W 1200	"P" Option N/A	DBO1818FT351G 1200	"M" Option N/A

[Click to view Statement of Line](#)

SIN: 33721

Occasional

Fluted Post Tables | Console Table

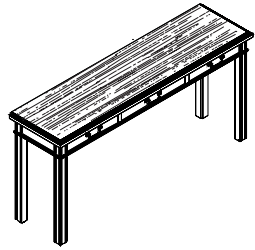

Product features

- 1-5/16" Thick top
- Floor levelers (adjustable 1/2")
- Solid hardwood base legs

Notes

- Tables are available in Cherry and Walnut Finishes
- Finish availability differs on each product. Please see Finish Matrix page for finishes available on Fluted Post tables.

STEP 1: Select Model
See table for sizing & pricing

STEP 2: Select Finish
[Click to view options](#)

STEP 3: Select Edge
[Click to view options](#)

STEP 4: Select Hardware
[Click to view options](#)

MODEL	w" x d" x h"	Wt.	Standard Veneer Top Standard Hardwood Base	Premium Veneer Top Premium Hardwood Base	HPL Top Standard Hardwood Base	TFL Top Standard Hardwood Base
Console Table	16 x 60 x 29	85	DBO1660JW361W 2392	"P" Option N/A	DBO1660JW361G 2392	"M" Option N/A
	16 x 48 x 29	75	DBO1648JW361W 2205	"P" Option N/A	DBO1648JW361G 2205	"M" Option N/A

[Click to view Statement of Line](#)

SIN: 33721

Occasional

Grove Small Round Table | Acacia Stool/Round Table

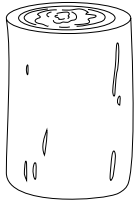

Product features

- Clear coat finish

Notes

- Butterflies are hand-placed based on the table's natural characteristics
- Every stool is unique with live edge detailing
- Natural cracks in the wood are considered normal and enhance the beauty of the stool

STEP 1: Select Model

See table for sizing & pricing

MODEL	w" x d" x h"	Wt.	Live Edge			
Round Table	16 dia x 21	140	GRO1621AS372W	1309		
* Stool/Table depth varies	12 dia x 17	50	GRO1217AS372W	1009		

[Click to view Statement of Line](#)

SIN: 33721

Occasional

Grove Square Table | Acacia Stool/Square Table

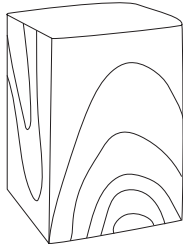

Product features

- Clear coat finish

Notes

- Butterflies are hand-placed based on the table's natural characteristics
- Every stool is unique with live edge detailing
- Natural cracks in the wood are considered normal and enhance the beauty of the stool
- Stools are cut from the Acacia Tree and has figured grain with distinct sap line edges

Options

PDS01-G: Salt (Powered USB) - \$527

- See Power & Data section for additional information

STEP 1: Select Model

See table for sizing & pricing

MODEL	w" x d" x h"	Wt.	Live Edge			
Square Table * Stool/Table depth varies	12 x 12 x 18	60	GRO1212CM373W 968			

[Click to view Statement of Line](#)

SIN: 33721

Occasional

Teak Square | Cocktail/Coffee/Side Table

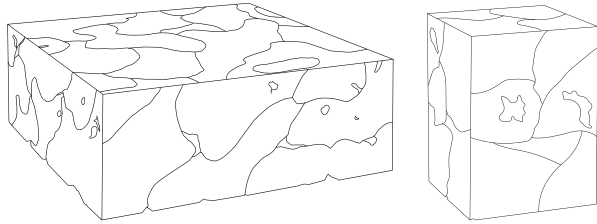

Product features

- Clear coat finish

Notes

- Crafted from scrap pieces of teak wood that are hand assembled.
- Color and character of wood grain may vary.
- Natural cracks and holes will be present.
- Tables are hollow, reducing weight.

STEP 1: Select Model

See table for sizing & pricing

MODEL	w" x d" x h"	Wt.	Natural Brown Finish			
Cocktail/Coffee Table	39 x 39 x 15	85	DBO3939TK369W	3331		
	47 x 31 x 15	85	DBO4731TK369W	3331		
Side Table	14 x 14 x 19	40	DBO1414TK366W	993		

[Click to view Statement of Line](#)

Occasional

Jackson Tables | Square End Table/Cocktail

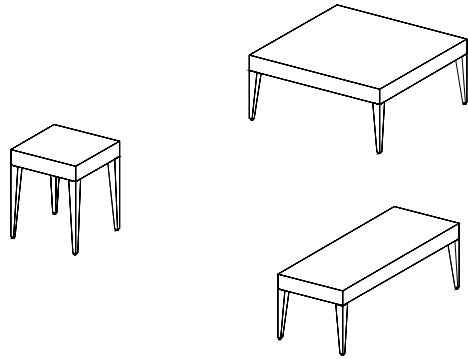

Product features

- 3-3/4" Thick top
- Flat-cut w/ reverse slip-matched veneer
- Glides
- Tapered solid hardwood legs

Notes

- Finish availability differs on each product. Please see Finish Matrix page for finishes available on Jackson tables.

STEP 1: Select Model

See table for sizing & pricing

STEP 2: Select Finish

[Click to view options](#)

MODEL	w" x d" x h"	Wt.	Standard Veneer Top Standard Hardwood Base	Premium Veneer Top Premium Hardwood Base	HPL Top Standard Hardwood Base	TFL Top Standard Hardwood Base
End Table	24 x 24 x 22	40	DBO2424JK366W 1531	"P" Option N/A	DBO2424JK366G 1531	"M" Option N/A
	18 x 18 x 22	35	DBO1818JK366W 1436	"P" Option N/A	DBO1818JK366G 1436	"M" Option N/A
Cocktail Table	48 x 18 x 16	50	DBO4818JK369W 2077	"P" Option N/A	DBO4818JK369G 2077	"M" Option N/A
	42 x 42 x 16	65	DBO4242JK369W 2312	"P" Option N/A	DBO4242JK369G 2312	"M" Option N/A
	36 x 36 x 16	55	DBO3636JK369W 2172	"P" Option N/A	DBO3636JK369G 2172	"M" Option N/A

[Click to view Statement of Line](#)

SIN: 33721

Occasional

Jackson Tables | Round Table

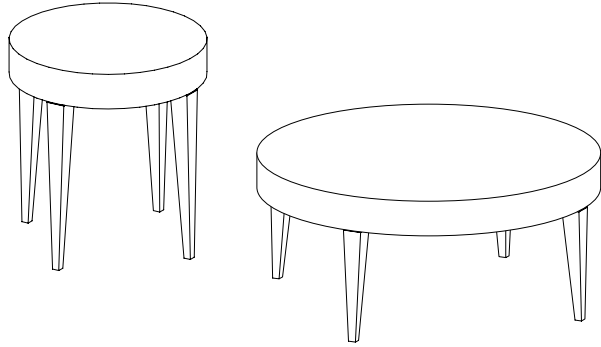

Product features

- 3-3/4" Thick top
- Flat-cut w/ reverse slip-matched veneer
- Glides
- Tapered solid hardwood legs

Notes

- Finish availability differs on each product. Please see Finish Matrix page for finishes available on Jackson tables.

STEP 1: Select Model

See table for sizing & pricing

STEP 2: Select Finish

[Click to view options](#)

MODEL	w" x d" x h"	Wt.	Standard Veneer Top Standard Hardwood Base	Premium Veneer Top Premium Hardwood Base	HPL Top Standard Hardwood Base	TFL Top Standard Hardwood Base
End Table	24 dia x 22	40	DBO2424JK367W 1811	"P" Option N/A	DBO2424JK367G 1811	"M" Option N/A
	18 dia x 22	35	DBO1818JK367W 1537	"P" Option N/A	DBO1818JK367G 1537	"M" Option N/A
Cocktail Table	42 dia x 16	65	DBO4242JK367W 2608	"P" Option N/A	DBO4242JK367G 2608	"M" Option N/A
	36 dia x 16	55	DBO3636JK367W 2283	"P" Option N/A	DBO3636JK367G 2283	"M" Option N/A

[Click to view Statement of Line](#)

SIN: 33721

Occasional

Jackson Tables | Console Tables

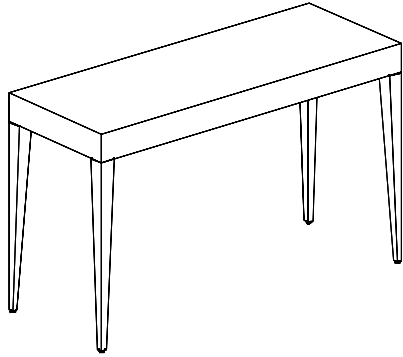

Product features

- 3-3/4" Thick top
- Flat-cut w/ reverse slip-matched veneer
- Glides
- Tapered solid hardwood legs

Notes

- Finish availability differs on each product. Please see Finish Matrix page for finishes available on Jackson tables.

STEP 1: Select Model

See table for sizing & pricing

STEP 2: Select Finish

[Click to view options](#)

MODEL	w" x d" x h"	Wt.	Standard Veneer Top Standard Hardwood Base	Premium Veneer Top Premium Hardwood Base	HPL Top Standard Hardwood Base	TFL Top Standard Hardwood Base
Console Table	48 x 18 x 29	60	DBO4818JK361W 2219	"P" Option N/A	DBO4818JK361G 2219	"M" Option N/A

[Click to view Statement of Line](#)

SIN: 33721

Occasional

Trade Street Tables | Square Table

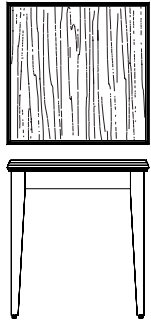

Product features

- 1-5/16" Thick top
- Glides
- Solid hardwood base and legs

Notes

- Tables are available in Cherry, Maple, and Walnut Finishes
- Finish availability differs on each product. Please see Finish Matrix page for finishes available on Trade Street tables.

STEP 1: Select Model
See table for sizing & pricing

STEP 2: Select Finish
[Click to view options](#)

STEP 3: Select Edge
[Click to view options](#)

MODEL	w" x d" x h"	Wt.	Standard Veneer Top Standard Hardwood Base		Premium Veneer Top Premium Hardwood Base	HPL Top Standard Hardwood Base		TFL Top Standard Hardwood Base
Cocktail Table	36 x 36 x 16	57	DBO3636TT366W	1623	"P" Option N/A	DBO3636TT366G	1623	"M" Option N/A
End Table	24 x 24 x 20	40	DBO2424TT366W	1425	"P" Option N/A	DBO2424TT366G	1425	"M" Option N/A
	18 x 18 x 20	35	DBO1818TT366W	1337	"P" Option N/A	DBO1818TT366G	1337	"M" Option N/A

[Click to view Statement of Line](#)

SIN: 33721

Occasional

Trade Street Tables | Round Table

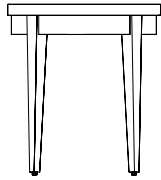

Product features

- 1-5/16" Thick top
- Glides
- Solid hardwood base and legs

Notes

- Tables are available in Cherry, Maple, and Walnut Finishes
- Finish availability differs on each product. Please see Finish Matrix page for finishes available on Trade Street tables.

STEP 1: Select Model
See table for sizing & pricing

STEP 2: Select Finish
[Click to view options](#)

STEP 3: Select Edge
[Click to view options](#)

MODEL	w" x d" x h"	Wt.	Standard Veneer Top Standard Hardwood Base		Premium Veneer Top Premium Hardwood Base	HPL Top Standard Hardwood Base		TFL Top Standard Hardwood Base
Cocktail Table	36 dia x 16	45	DBO3636TT367W	1808	"P" Option N/A	DBO3636TT367G	1808	"M" Option N/A
End Table	24 dia x 20	35	DBO2424TT367W	1583	"P" Option N/A	DBO2424TT367G	1583	"M" Option N/A
	18 dia x 20	30	DBO1818TT367W	1479	"P" Option N/A	DBO1818TT367G	1479	"M" Option N/A

[Click to view Statement of Line](#)

SIN: 33721

Occasional

Trade Street Tables | Cocktail Table



Product features

- 1-5/16" Thick top
- Glides
- Solid hardwood base and legs

Notes

- Tables are available in Cherry, Maple, and Walnut Finishes
- Finish availability differs on each product. Please see Finish Matrix page for finishes available on Trade Street tables.

STEP 1: Select Model

See table for sizing & pricing

STEP 2: Select Finish

[Click to view options](#)

STEP 3: Select Edge

[Click to view options](#)

MODEL	w" x d" x h"	Wt.	Standard Veneer Top Standard Hardwood Base	Premium Veneer Top Premium Hardwood Base	HPL Top Standard Hardwood Base	TFL Top Standard Hardwood Base
Cocktail Table	18 x 48 x 16	50	DBO1848TT369W 1876	"P" Option N/A	DBO1848TT369G 1876	"M" Option N/A

[Click to view Statement of Line](#)

SIN: 33721

Occasional

Trade Street Tables | Console Table

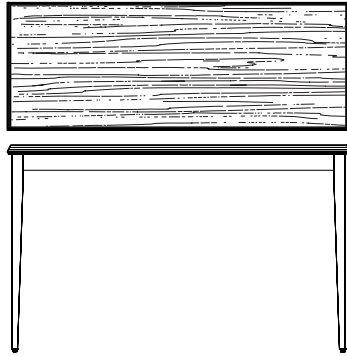

Product features

- 1-5/16” Thick top
- Glides
- Solid hardwood base and legs

Notes

- Tables are available in Cherry, Maple, and Walnut Finishes
- Finish availability differs on each product. Please see Finish Matrix page for finishes available on Trade Street tables.

STEP 1: Select Model

See table for sizing & pricing

STEP 2: Select Finish

[Click to view options](#)

STEP 3: Select Edge

[Click to view options](#)

MODEL	w” x d” x h”	Wt.	Standard Veneer Top Standard Hardwood Base	Premium Veneer Top Premium Hardwood Base	HPL Top Standard Hardwood Base	TFL Top Standard Hardwood Base
Console Table	18 x 60 x 29	70	DBO1860TT361W 2445	“P” Option N/A	DBO1860TT361G 2445	“M” Option N/A
	18 x 48 x 29	60	DBO1848TT361W 2064	“P” Option N/A	DBO1848TT361G 2064	“M” Option N/A

[Click to view Statement of Line](#)

SIN: 33721

Power & Data Options

Salt & Pepper Power Ports

Style Number	List Price
PDS01 Salt (powered USB)	\$527

Specifications

- Size: 1-3/4" Diameter
- When Salt is used with Grove Square Stool an additional \$200 LIST will apply for the special cutout required. List price above is reflective of the additional \$200 charge.
- Pepper port includes 1 power plug
- Salt ports include power USB-A and USB-C
- 72" Cord
- Spill-proof technology
- Available in Black, White, Fog, or Storm finish

Note: Available on Grove Square Stool only



Salt Powered USB



Additional colors available upon request. Contact Customer Service for additional color options.