

Homeowners Guide

Bath Whirlpool

K-702

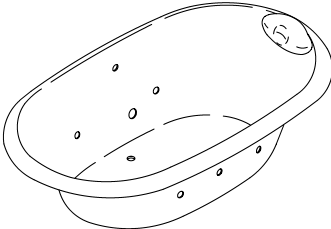

THE BOLD LOOK
OF **KOHLER**®

Operating Instructions

INSTRUCTIONS PERTAINING TO A RISK OF FIRE, ELECTRIC SHOCK, OR INJURY TO PERSONS READ AND FOLLOW ALL INSTRUCTIONS

 **WARNING:** When using electrical products, basic precautions should always be followed, including the following:

 **DANGER: Risk of personal injury.** To reduce the risk of injury, do not permit children to use this unit unless they are closely supervised at all times.

 **WARNING: Risk of personal injury.** To avoid injury, exercise care when entering or exiting the whirlpool.

 **WARNING: Risk of electric shock.** Do not permit electric appliances (such as a hair dryer, lamp, telephone, radio, or television) within 5' (1.5m) of this whirlpool.

 **WARNING: Risk of hyperthermia.** People using medications and/or having an adverse medical history should consult a physician before using a whirlpool equipped with a heater.

An equipment grounding terminal is provided in the field wiring compartment. To reduce the risk of electric shock, this terminal must be connected to the grounding means provided in the electric supply panel with a conductor equivalent in size to the circuit conductors supplying this whirlpool.

A pressure wire connector is provided on the exterior of the pump or control within this unit to permit connection of a bonding conductor between this unit and all other exposed metal in the vicinity, as needed to comply with local requirements.

Use this whirlpool only for its intended purpose as described in this manual. Do not use attachments not recommended by the manufacturer.

Never drop or insert any object into any opening.

Do not operate this unit without the guard (cover) over the suction fitting.

The whirlpool must be connected only to a supply circuit that is protected by a Ground-Fault Circuit-Interrupter (GFCI) or Earth-Leakage Circuit-Breaker (ELCB). Such a GFCI or ELCB should be provided by the installer and should be tested on a routine basis. To test the GFCI or ELCB, press the test button. The GFCI or ELCB should interrupt power. Press the reset button. Power should be restored. If the GFCI or ELCB fails to operate in this manner, the GFCI or ELCB is defective. If the GFCI or ELCB interrupts power to the bath without the test button being pressed, a ground current is flowing, indicating the possibility of an electric shock. Do not use this whirlpool bath. Disconnect the whirlpool and have the problem corrected by a qualified service representative before using.

SAVE THESE INSTRUCTIONS

 **WARNING: The use of alcohol, drugs, or medication can greatly increase the risk of fatal hyperthermia.**

Prolonged immersion in hot water may induce hyperthermia. Hyperthermia occurs when the internal temperature of the body reaches a level several degrees above the normal body temperature of 98.6°F (37°C). The symptoms of hyperthermia include an increase in the internal temperature of the body, dizziness, lethargy, drowsiness, and fainting. The effects of hyperthermia include: (a) failure to perceive heat, (b) failure to recognize the need to exit the bath, (c) unawareness of impending hazard, (d) fetal damage in pregnant women, (e) physical inability to exit the bath, and (f) unconsciousness resulting in the danger of drowning.

IMPORTANT! Flush your whirlpool system twice a month or more depending upon usage, as described on Page 6.

Do not allow the water temperature in the whirlpool to exceed 104°F (40°C).

Keep small objects such as bath toys and bathing accessories out of the whirlpool while the unit is running. Repeated use of personal care products containing oils can damage plastic whirlpool components. Do not use heavy, vegetable-based shampoos or bath oils.

Whirlpool hydro-massage action can cause even a small amount of bubble bath, bath soap, shampoo, or bath oil to foam excessively. For this reason, please don't use these products during whirlpool operation.

Table of Contents

Thank You	4
Your Kohler Whirlpool	4
User Keypad & Whirlpool Modes/Features	5
Optional Remote Control	5
Operating Your Whirlpool	5
Care and Cleaning	6
Warranties - U.S.A. and Canada	7
One-Year Warranty - Mexico	9
Troubleshooting	10
Service Parts	12

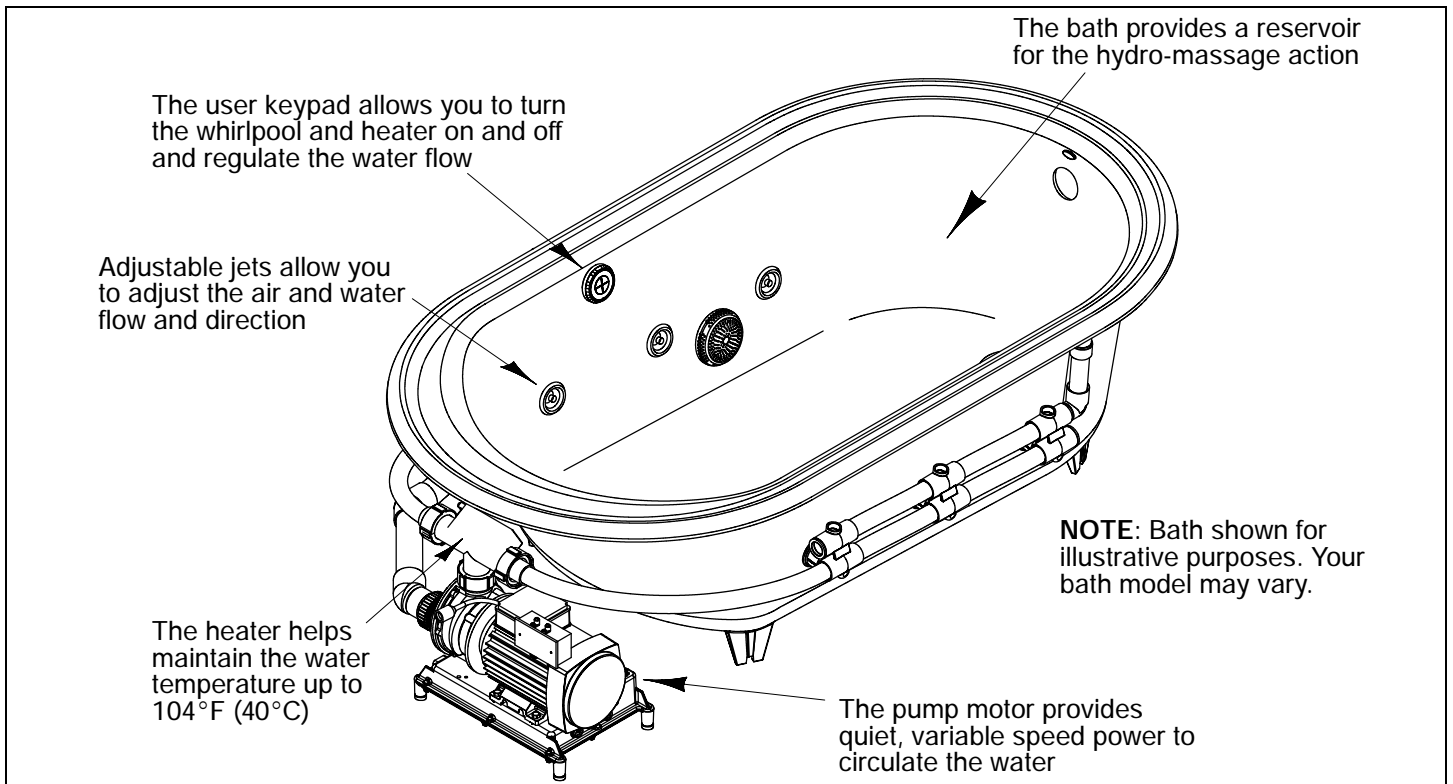

Thank You For Choosing Kohler

Thank you for choosing The Bold Look of Kohler. Kohler craftsmanship offers you a rare combination of proven performance and graceful sophistication that will satisfy you for years to come. The dependability and beauty of your new whirlpool will surpass your highest expectations. We're proud of our whirlpools here at Kohler, and we know you will be too.

Please take a few minutes to study this Homeowners Guide before you use your whirlpool. Pay special attention to the Care and Cleaning instructions on Page 6.

All information in this manual is based upon the latest product information available at the time of publication. At Kohler, we constantly strive to improve the quality of our products. We reserve the right to make changes in product characteristics, packaging, or availability at any time without notice.

Your Kohler Whirlpool

Your new whirlpool is designed to stimulate, invigorate, and energize your body with comforting hydro-massage therapy. The whirlpool consists of the following components:

- **Bath** - acts as a reservoir for water, and provides a location for the hydro-massage action.
- **User Keypad** - located within easy reach, the keypad allows you to turn the whirlpool and heater on and off and regulate the water flow through the jets.
- **Pump Motor** - provides quiet, variable speed power to circulate the water and create the soothing hydro-massage action.
- **Adjustable Jets** - positioned to optimize their hydro-massage effect, the jets allow you to adjust the air and water flow and control the flow direction as you desire.
- **Heater** - designed to automatically help maintain the temperature of the water up to 104°F (40°C) to enhance your hydro-massage experience. The heater turns on automatically when the whirlpool is operating, and turns off when the pump motor is turned off. The heater may be turned off, through the keypad, at any time while the pump is operating.

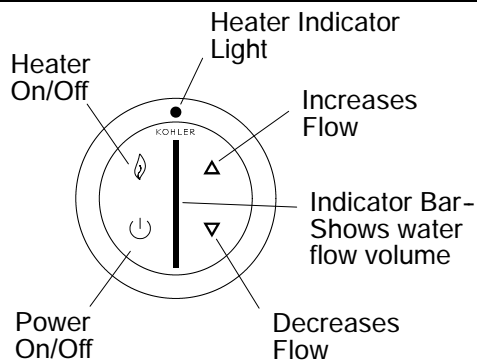

Lighted User Keypad

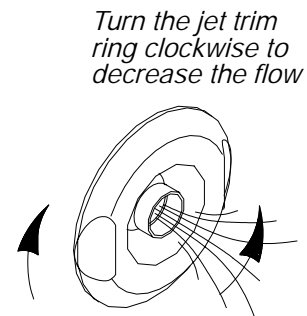

Turn the jet trim ring counterclockwise to increase the flow

User Keypad and Whirlpool Modes/Features

- **Power-** Turns the whirlpool pump on and off.
- **Up Arrow-** Increases the water flow.
- **Down Arrow-** Decreases the water flow.
- **Heater-** The heater automatically engages when the whirlpool is turned on. You may turn the heater off by pressing the heater button. Press the button a second time to turn the heater back on.
- **Indicator Bar-** Shows the water flow volume.

Optional Remote Control

If you purchased a remote control, please refer to the Homeowners Guide packed with your remote control for detailed information.

Operating Your Whirlpool

- Turn the jet trim fully counterclockwise. Position the jet nozzles so they face down toward the basin.
NOTE: The water temperature in the whirlpool should never exceed 104°F (40°C). A built-in heater automatically maintains the water temperature when the whirlpool is running, as long as the water temperature does not exceed 104°F (40°C). The heater will disengage at higher temperatures.
- Close the drain, and fill the whirlpool to a level at least 2" (5cm) above the top of the highest jet. Use your hand to test the water temperature for comfort and safety, then carefully enter the bath.
- Press Power to turn on the whirlpool. The whirlpool will start at medium volume. The heater will also turn on and the heater icon will illuminate.
- Increase or decrease the water flow by pressing the up or down arrows on the keypad. An indicator bar in the center of the keypad shows the water flow volume.
- Adjust the jets for optimum air/water mixture. Turn the jet trim clockwise to reduce the flow, and counterclockwise to increase the flow. Position the jet nozzles to direct the water flow as desired to maximize your hydro-massage experience.
- The heater automatically engages when the whirlpool is turned on. You may turn the heater off by pressing the heater button on the keypad. Press the button a second time to turn the heater back on.
- Press Power a second time to turn off the whirlpool.
NOTE: Your whirlpool will automatically stop after approximately 20 minutes of continuous operation. You can restart the whirlpool, if you desire, by pressing Power.
- Carefully exit the bath, and open the drain to empty the whirlpool.
NOTE: If the whirlpool does not function properly, please refer to Troubleshooting on Page 10.

Care and Cleaning Instructions

Cleaning Your Kohler Cast Iron Whirlpool

- Rinse the whirlpool thoroughly after each use and use a soft cloth to wipe it dry. If the surface becomes dirty, use a general purpose cleaner such as Scrub Free® Mildew Stain Remover, Clorox Clean-Up®, Glass Plus®, Windex® Original, Fantastic® All Purpose, Mr. Clean Top Job, Formula 409® All Purpose, Lysol® Basin, Tub & Tile Cleaner or Scrubbing Bubbles® Bathroom Cleaner.

IMPORTANT! Use water soluble cleaners (dissolve 100% in water). Cream-based cleaners may have a tendency to build up, reducing the friction on slip-resistant surfaces.

- BCD Rog 3 Non-Acid Bathroom Cleaner may be used on the Safeguard surface or whirlpool. It is not sold commercially. Call 1-800-470-8337 to order. A soft nylon brush may be used on the Safeguard surface.
- Do not use steel wool, wire brushes or abrasive sponge pads. In the rare occurrence of stubborn stains, use abrasives or abrasive cleaners sparingly, but not on the Safeguard surface on the bottom of the whirlpool.
- For occasional rust removal you may use Whink® Rust & Iron Stain Remover or Muriatic Acid.

Cleaning Your User Keypad and Remote Control

- Use a soft cloth to wipe the keypad and remote control after each use. If the surface becomes dirty, use a non-abrasive soap and warm water to clean.

Flushing Your Whirlpool System

Flush your whirlpool system twice a month or more, depending upon usage. Use the following sequence:

- Turn the jet trim rings fully clockwise to remove air induction.
- Fill the whirlpool with warm water to a level at least 2" (5cm) above the highest jets, or leave water in the whirlpool after using.
- Add 2 tablespoons (30 ml) of a low-foaming dishwasher detergent and 20 ounces (590 ml) of household bleach (5% - 6% sodium hypochlorite) to the water.
- Run the whirlpool for 5 to 10 minutes. Turn off the whirlpool and drain.
- If desired, rinse the bath surfaces with water.
- Rinse the surfaces of the jets, faucet, handrails, drain, etc. and wipe them dry with a soft cloth.

Limited One-Year Warranty - USA and Canada

KOHLER® plumbing fixtures, faucets and fittings are warranted to be free of defects in material and workmanship for one year from date of installation.

Kohler Co. will, at its election, repair, replace or make appropriate adjustment where Kohler Co. inspection discloses any such defects occurring in normal usage within one year after installation. Kohler Co. is not responsible for removal or installation costs.

To obtain warranty service, contact Kohler Co. either through your Dealer, Plumbing Contractor, Home Center or E-tailer, or by writing Kohler Co., Attn: Customer Service Department, 444 Highland Drive, Kohler, WI 53044, USA, or by calling 1-800-4-KOHLER from within the USA, 1-800-964-5590 from within Canada and 001-877-680-1310 from within Mexico.

Implied warranties including that of merchantability and fitness for a particular purpose are expressly limited in duration to the duration of this warranty. Kohler Co. disclaims any liability for special, incidental or consequential damages. Some states/provinces do not allow limitations on how long an implied warranty lasts, or the exclusion or limitation of special, incidental or consequential damages so these limitations and exclusions may not apply to you. This warranty gives you specific legal rights. You may also have other rights which vary from state/province to state/province.

This is our exclusive written warranty.

Notes:

1. There may be variation in color fidelity between catalog images and actual plumbing fixtures.
2. Kohler Co. reserves the right to make changes in product characteristics, packaging or availability at any time without notice.

COPYRIGHT © 1999, 2000, 2001, 2002 BY KOHLER CO.

Lifetime Limited Warranty - USA and Canada

Kohler warrants the cast iron components of this product manufactured after February 10, 2000, to be free of defects in material and workmanship during normal residential use for as long as the original consumer purchaser owns his/her home. Gloss reduction, scratching, staining and alkaline etching, of the finish over time due to use, cleaning practices or water or atmospheric conditions are not manufacturing defects but are indicative of normal wear and tear. This warranty applies only for KOHLER Cast Iron product installed in the United States of America, Canada and Mexico.

If a defect is found in normal residential use, Kohler Co. will, at its election, repair, replace or make appropriate adjustment. Damage caused by accident, misuse, or abuse is not covered by this warranty. Improper care and cleaning will void the warranty. Proof of purchase (original sales receipt) must be provided to Kohler with all warranty claims. Kohler Co. is not responsible for labor charges, installation, or other incidental or consequential costs. In no event shall the liability of Kohler exceed the purchase price of the product.

If the cast iron product is used commercially or is installed outside of North America, Kohler warrants the cast iron product to be free from defects in material and workmanship for one (1) year from the date the product is installed, with all other terms of this warranty applying except duration. All other components other than the enameled cast iron carry Kohler's one-year limited warranty unless otherwise specified.

If you believe that you have a warranty claim, contact Kohler Co., either through your Dealer, Plumbing Contractor, Home Center or E-tailer, or by writing: Kohler Co., Attn.: Customer Service Department, 444 Highland Drive, Kohler, WI 53044, USA. Please be sure to provide all pertinent information regarding your claim, including a complete description of the problem, the product, model number, color, finish, the date the product was purchased and from whom the product was purchased. Also include your original invoice. For other information, or to obtain the name and address of the service and repair facility nearest you call 1-800-4-KOHLER from within the USA, 1-800-964-5590 from within Canada, and 001-877-680-1310 from within Mexico.

The foregoing warranties are in lieu of all other warranties, express or implied, including but not limited to the implied warranties of merchantability and fitness for a particular purpose.

Seller disclaims any liability for special, incidental or consequential damages. Some states/provinces do not allow limitations on how long an implied warranty lasts, or the exclusion or limitation of special, incidental or consequential damages, so these limitations and exclusions may not apply to you. This warranty gives you specific legal rights. You may also have other rights, which vary, from state/province to state/province.

This is our exclusive written warranty.

One-Year Warranty - For Mexico

KOHLER CO.

It is recommended that at the time of purchase, you verify that all accessories and components are complete in this package.

This Kohler product is warranted to be free of defects in material and workmanship for one (1) year from the date of purchase as shown on the invoice or receipt.

1. Kohler Co. will only service its commercialized products through its authorized distributors.
2. To obtain warranty service, please present the invoice and corresponding warranty.
3. Through its authorized distributors, Kohler Co. promises to repair the defective product or provide a new replacement or an equivalent model (in those cases that the model has been discontinued) when the product is beyond repair, without any charge to the consumer.
4. The time of repair will not exceed six (6) weeks commencing on the date the product is received.
5. It is recommended that the consumer save the invoice or receipt as additional protection, as it may substitute the warranty in the case that there is a discrepancy in the validity of the warranty.

EXCEPTIONS & RESTRICTIONS

The Warranty will not be valid in the following cases:

1. When the product is not operated in accordance with the instructions concerning use and operation set forth in the owner's manual or installation instructions, and when the recommendations and warnings included are not observed.
2. When the product has been modified or dismantled partially or totally; or has been used in a negligent fashion and as a consequence has suffered damages attributable to the consumer, individual, or hardware not authorized by Kohler Co.
3. This warranty does not cover the damages as a result of disaster such as fire or acts of God, including flooding, earthquake, or electric storms, etc.

To obtain a list of distributors in your area where you can exercise your rights under this warranty, please call 001-877-680-1310.

KOHLER CO., KOHLER, WI 53044 U.S.A.

IMPORTER:

INTERNACIONAL DE CERÁMICA, S.A. DE C.V.

AV. CARLOS PACHECO NO. 7200

Troubleshooting Procedures

This troubleshooting guide is for general aid only. A Kohler Authorized Service Representative or qualified electrician should correct all electrical problems. For warranty service, contact your dealer or wholesale distributor.

Troubleshooting the Whirlpool System

Symptoms	Probable Causes	Recommended Action
1. User keypad does not illuminate when power button is pressed or outer ring is rotated.	A. No power to control.	A. Check wiring and connect power. If problem persists, refer to installer/dealer.
	B. GFCI or ELCB tripped.	B. Reset GFCI or ELCB.
	C. Wiring harness from user keypad to control is loose, disconnected or damaged.	C. Check wiring for proper connections. Replace wiring harness if necessary. Refer to installer/dealer.
	D. Faulty user keypad.	D. Replace user keypad. Refer to installer/dealer.
	E. Faulty control.	E. Replace control. Refer to installer/dealer.
2. Motor starts, but all jets are not functioning.	A. Jet is closed.	A. Rotate jet trim counterclockwise to open.
	B. Jet not installed correctly.	B. Reinstall jet; check for O-ring damage.
	C. Jets are blocked.	C. Remove blockage.
3. User keypad is illuminated, but does not respond to buttons or ring.	A. Control program is locked.	A. Reset GFCI or ELCB.
	B. Wiring harness from user keypad to control is loose, disconnected or damaged.	B. Check wiring for proper connections. Replace wiring harness if necessary. Refer to installer/dealer.
	C. Faulty user keypad.	C. Replace user keypad. Refer to installer/dealer.
	D. Faulty control.	D. Replace control. Refer to installer/dealer.
4. User keypad indicator bar keeps scanning at power-up.	A. Control program is locked.	A. Reset GFCI or ELCB.
	B. Wiring harness from user keypad to control is loose, disconnected or damaged.	B. Check wiring for proper connections. Replace wiring harness if necessary. Refer to installer/dealer.
	C. Faulty user keypad.	C. Replace user keypad. Refer to installer/dealer.
	D. Faulty control.	D. Replace control. Refer to installer/dealer.
5. User keypad is illuminated, but pump won't start.	A. Power cord from pump to control is loose, disconnected or damaged.	A. Check wiring for proper connections. If problem persists, refer to installer/dealer.
	B. Faulty pump.	B. Replace pump. Refer to installer/dealer.
	C. Faulty control.	C. Replace control. Refer to installer/dealer.
6. Motor runs but pump won't prime (cavitates).	A. Pump is shimmed too high.	A. Lower pump/control to subfloor level.
	B. Small air leak at pump inlet.	B. Securely tighten nut(s) on intake side of pump.
	C. Faulty motor/pump.	C. Replace motor/pump. Refer to installer/dealer.
	D. Faulty control.	D. Replace control. Refer to installer/dealer.

Troubleshooting *continued*

7. Pump stops before 18 minutes.	A. GFCI or ELCB tripped.	A. Identify source of fault, and correct. Reset GFCI or ELCB.
	B. Suction is blocked.	B. Remove obstruction.
	C. Jets are blocked.	C. Remove blockage.
	D. Motor overheated and protection device activated.	D. Check for blockage at suction and/or jets. Remove blockage and allow motor to cool.
8. Pump does not automatically stop after 22 minutes.	A. 20-minute timer inadvertently disabled.	A. See service manual.
9. Pump won't turn off when the power button on user keypad is pressed.	A. Faulty user keypad.	A. Replace user keypad. Refer to installer/dealer.
	B. Faulty control.	B. Replace control. Refer to installer/dealer.
10. Pump operates but variable speed feature does not work.	A. Faulty motor/pump.	A. Replace motor/pump. Refer to installer/dealer.
	B. Faulty control.	B. Replace control. Refer to installer/dealer.
11. Bath water cools while pump is operating.	A. Water temperature above 104°F (40°C).	A. Allow bath water to cool.
	B. Heater is turned off on user keypad.	B. Turn heater on.
	C. Wiring from heater to control is loose, disconnected or damaged.	C. Check wiring for proper connections. Refer to installer/dealer.
	D. Faulty heater.	D. Replace heater. Refer to installer/dealer.
	E. Faulty control.	E. Replace control. Refer to installer/dealer.
12. Noisy operation.	A. Pump banding straps have not been cut.	A. Cut pump banding straps with tin snips.
	B. Dry or dislodged jet O-ring (squeal).	B. Remove jet, replace and lubricate O-ring, and reinstall jet.
13. Remote control (if equipped) does not work.	A. Batteries improperly installed or dead.	A. Replace batteries.
	B. Antenna on wiring harness is damaged.	B. Replace wiring harness. Refer to installer/dealer.
	C. Remote control not programmed correctly.	C. See homeowners guide or service manual.
	D. Faulty remote control.	D. Replace remote control.
	E. Faulty control.	E. Replace control. Refer to installer/dealer.

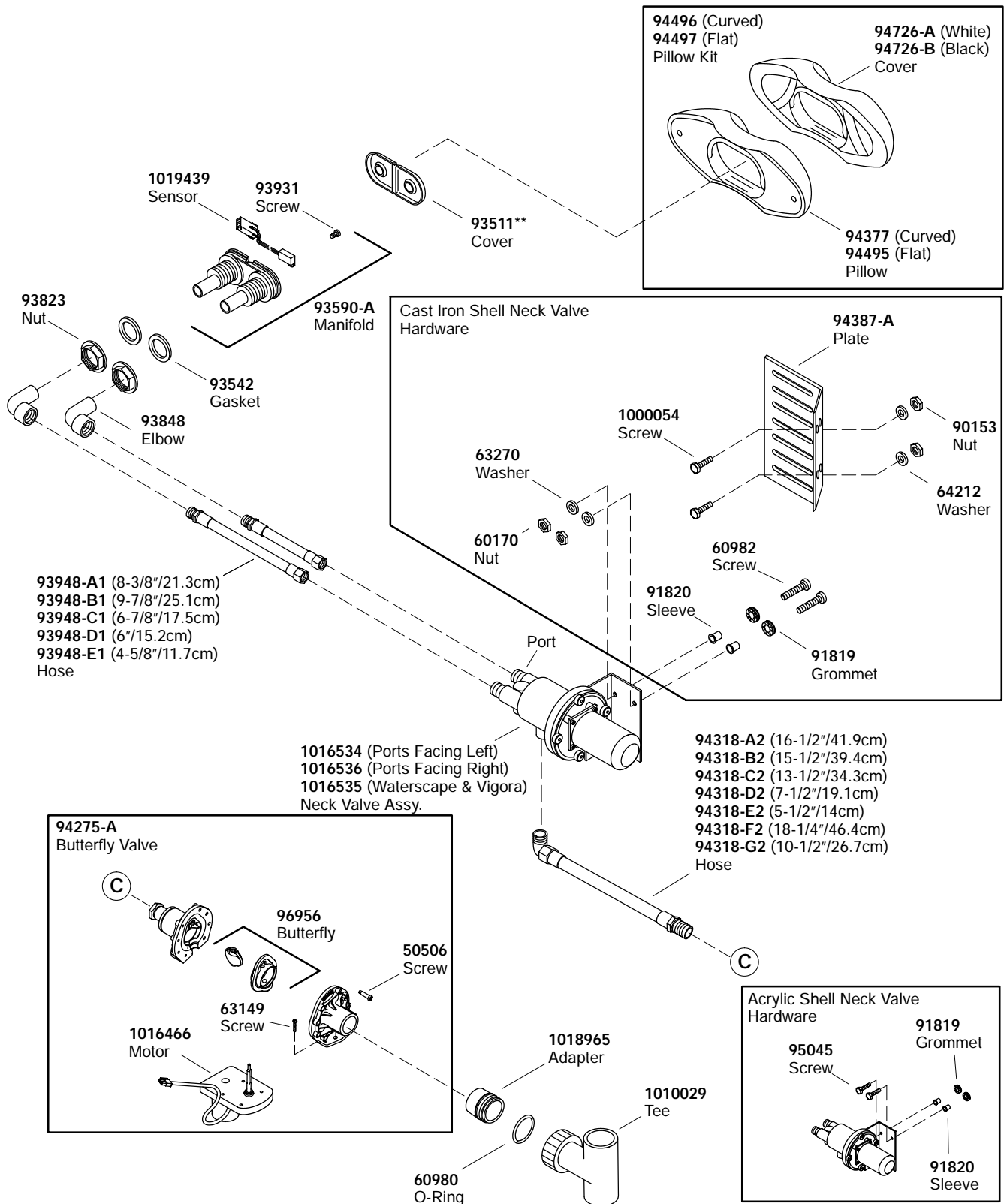

**Finish/color code must be specified when ordering.

Service Parts

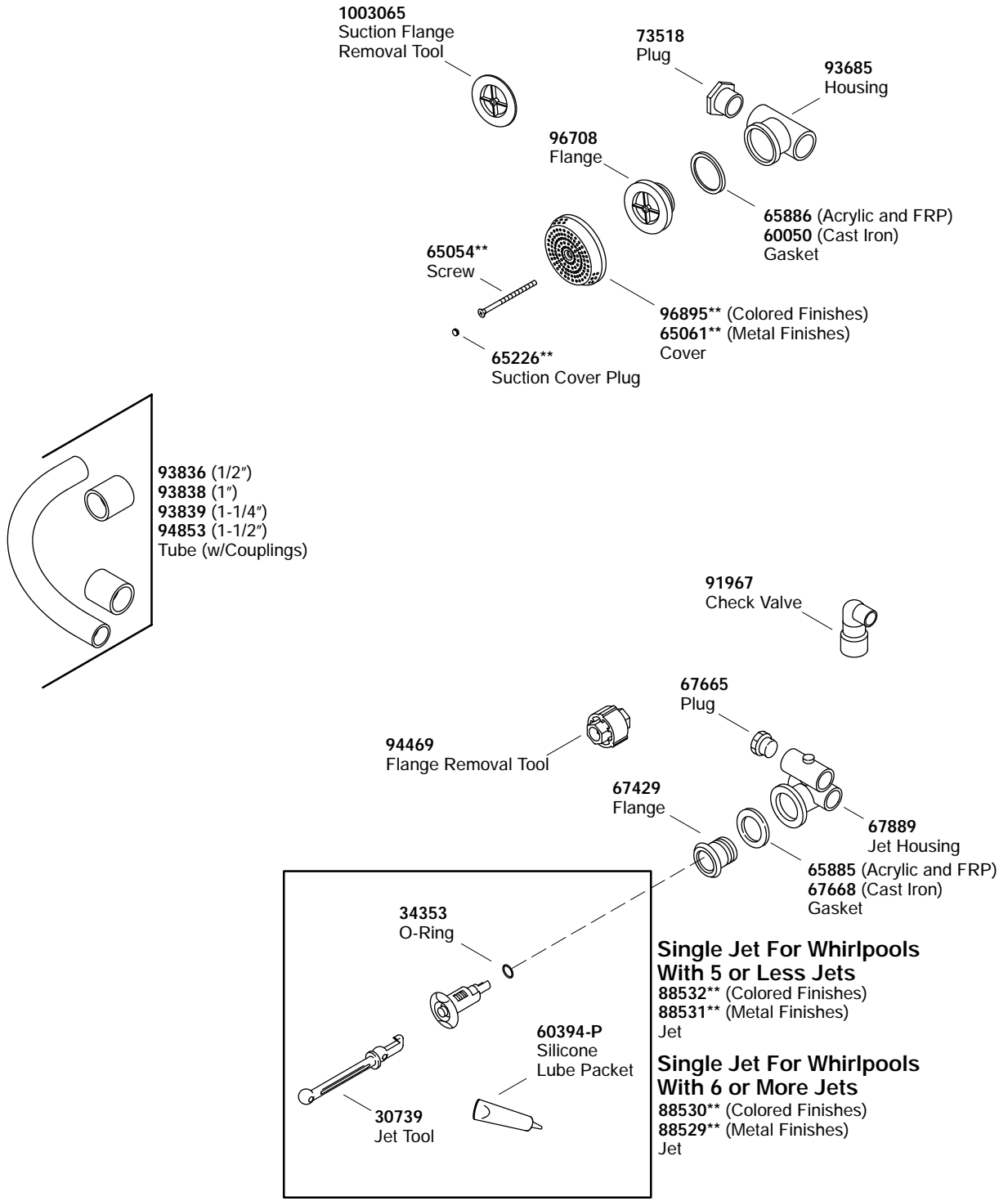

****Finish/color code must be specified when ordering.**

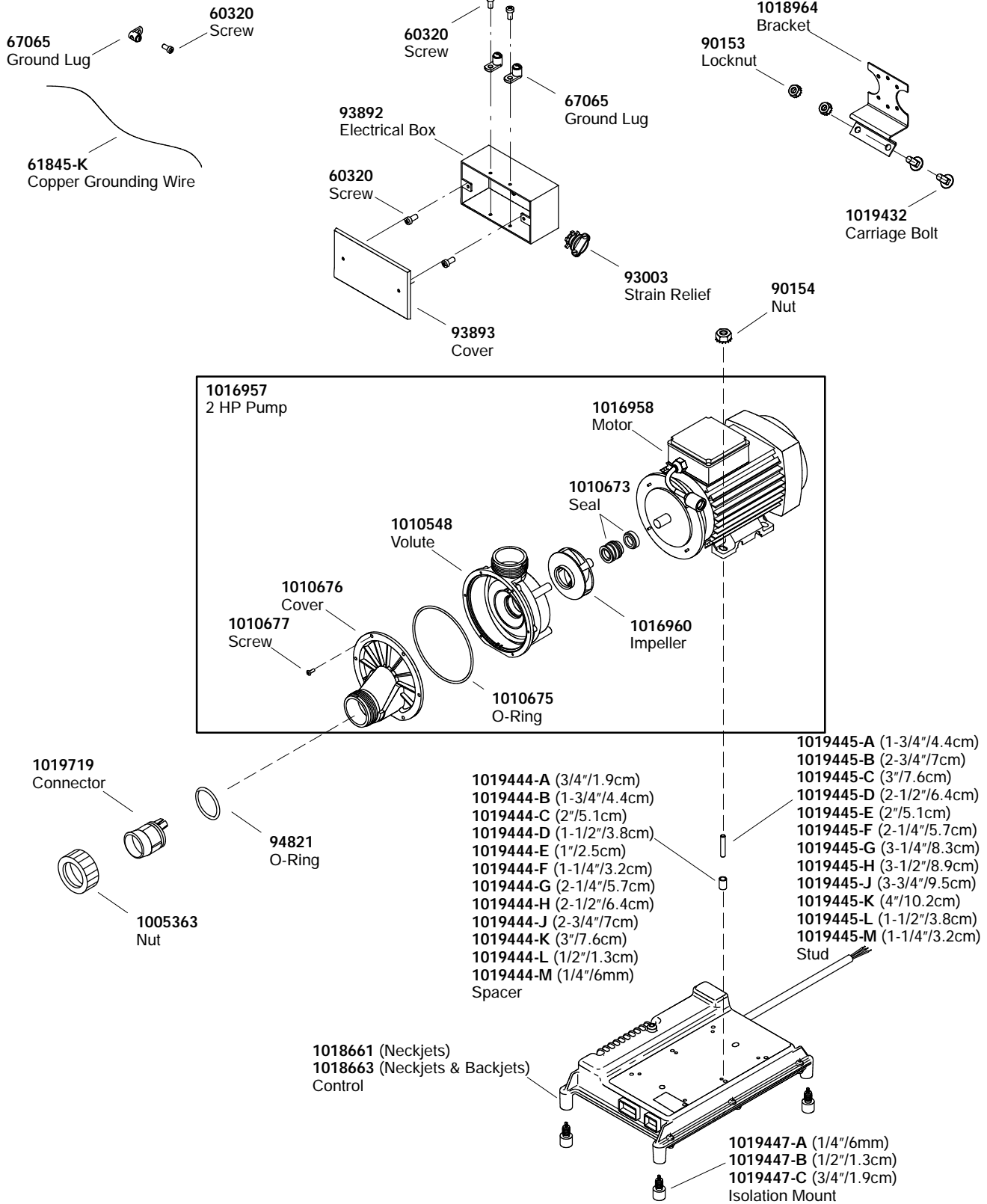

****Finish/color code must be specified when ordering.**

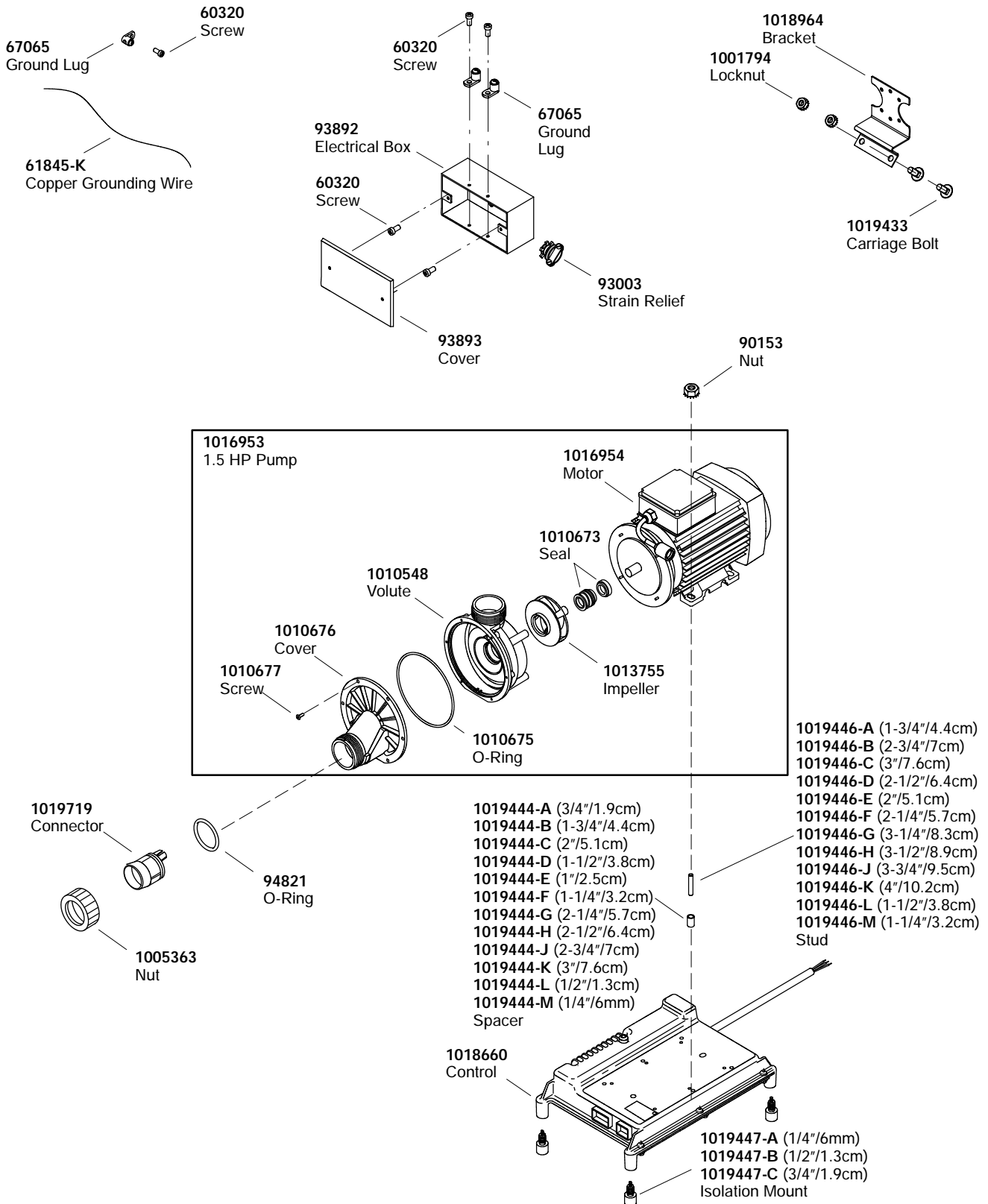

****Finish/color code must be specified when ordering.**

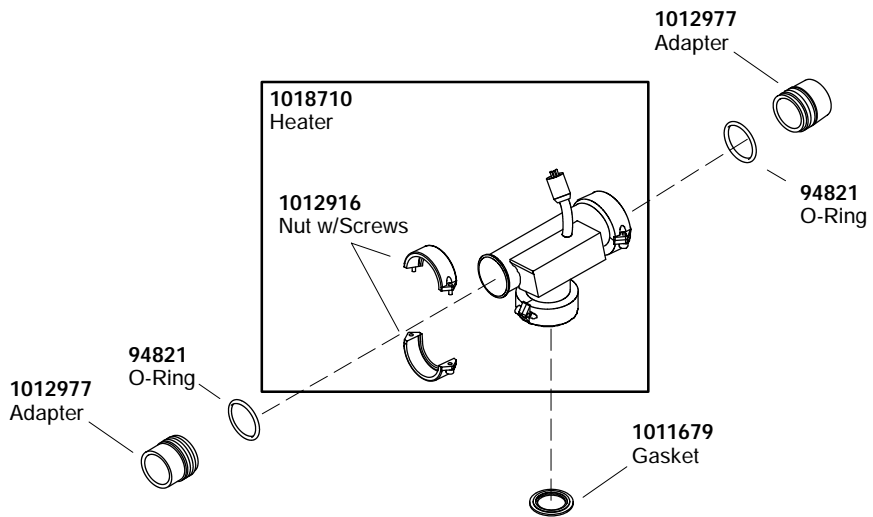
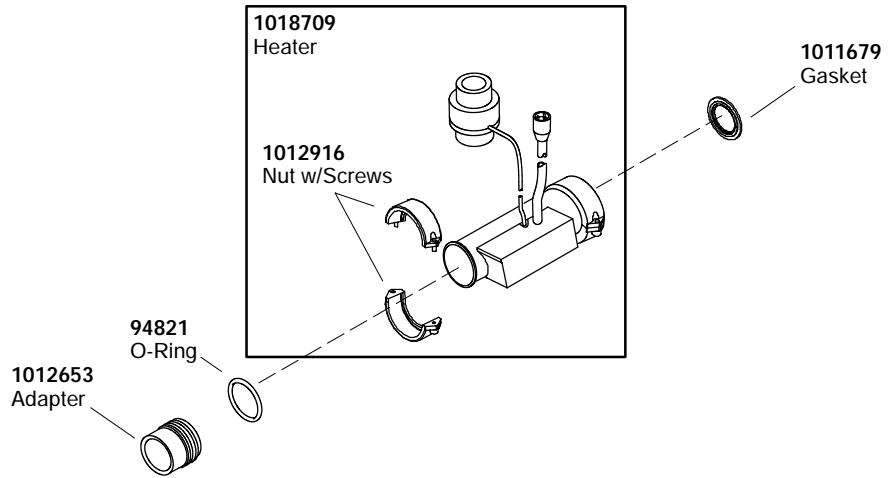

****Finish/color code must be specified when ordering.**

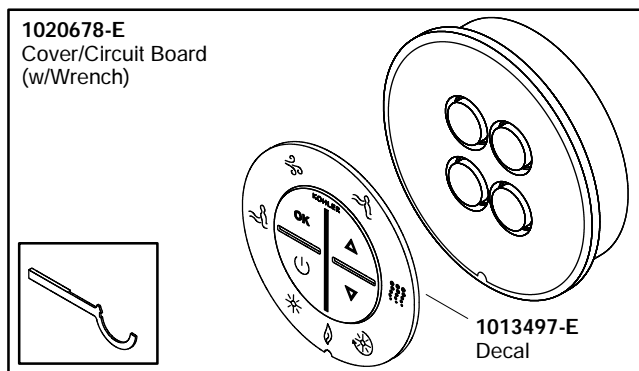
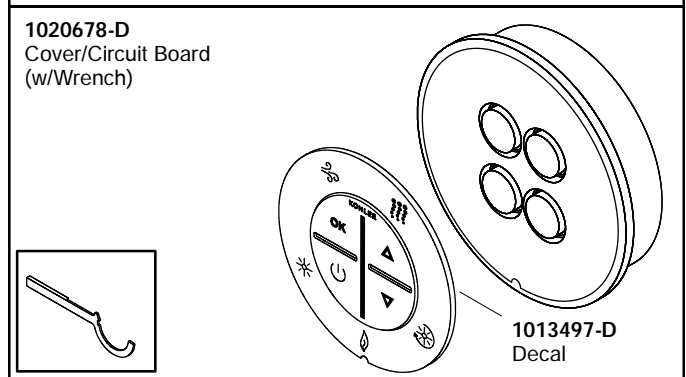
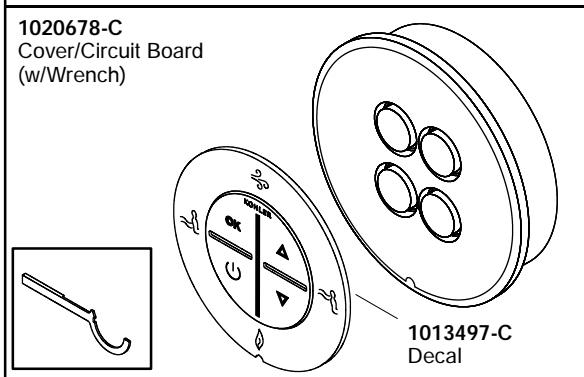
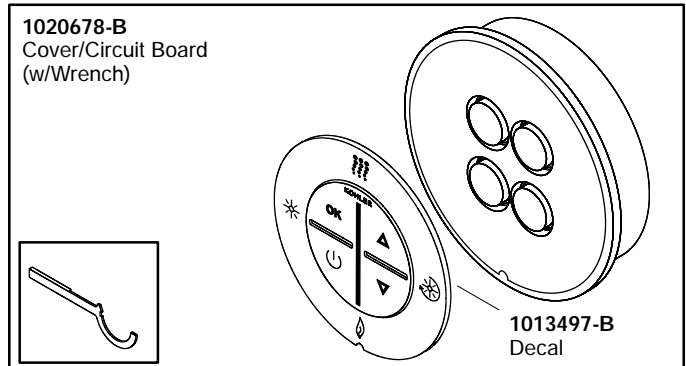
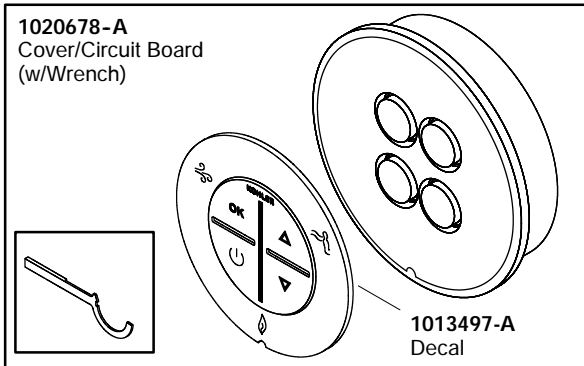
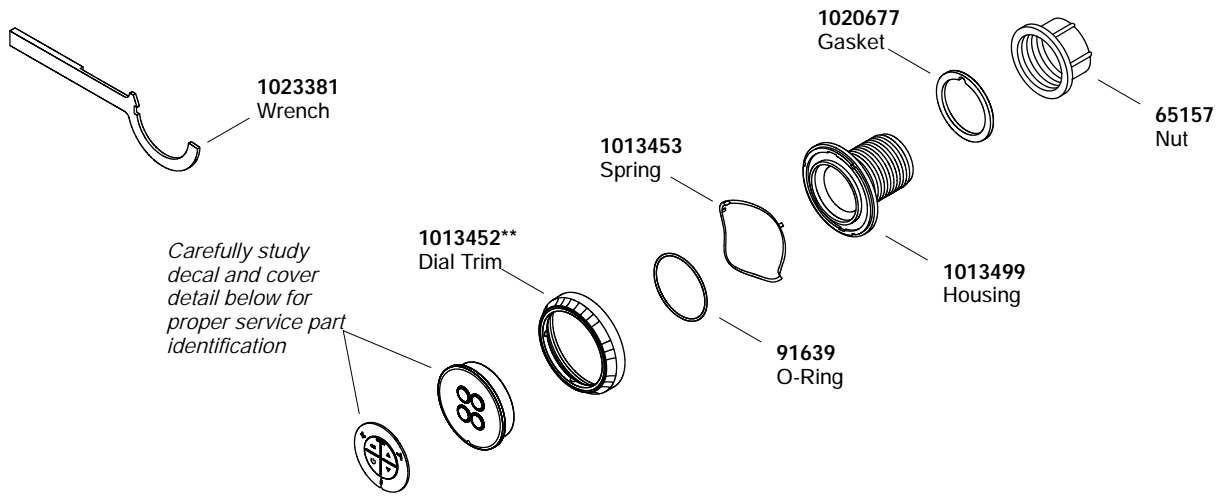

****Finish/color code must be specified when ordering.**

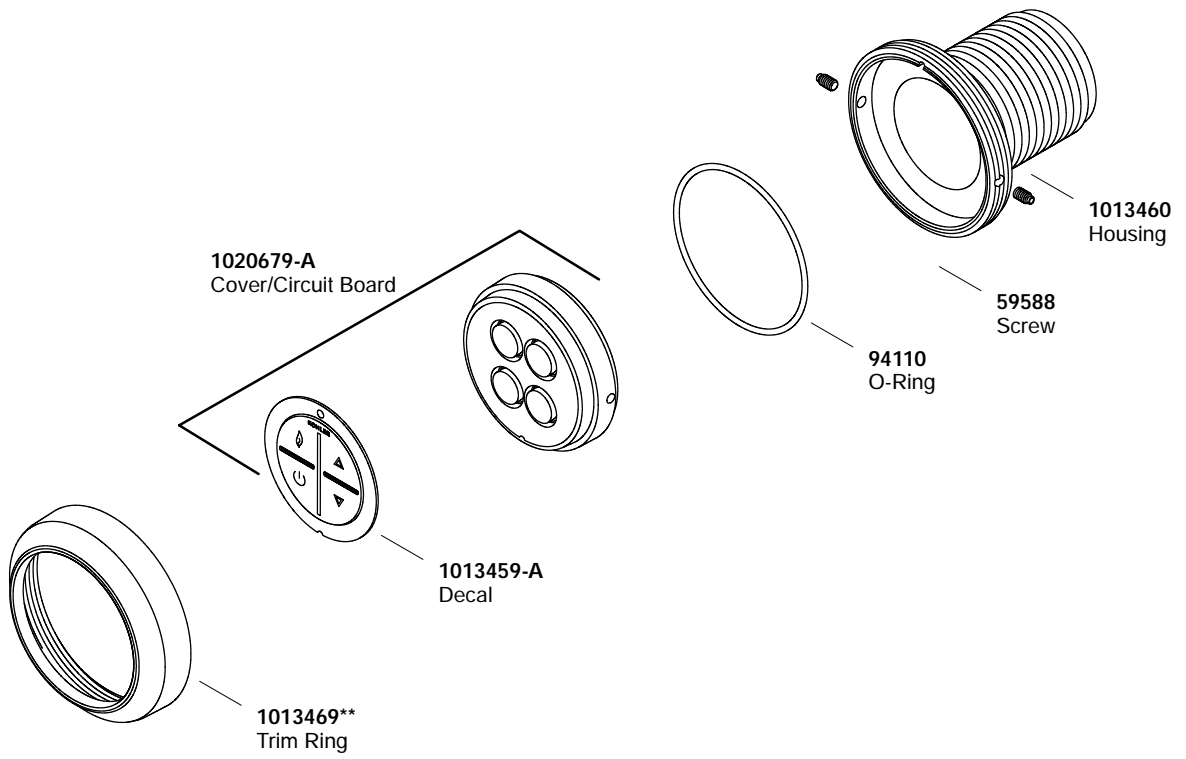

****Finish/color code must be specified when ordering.**

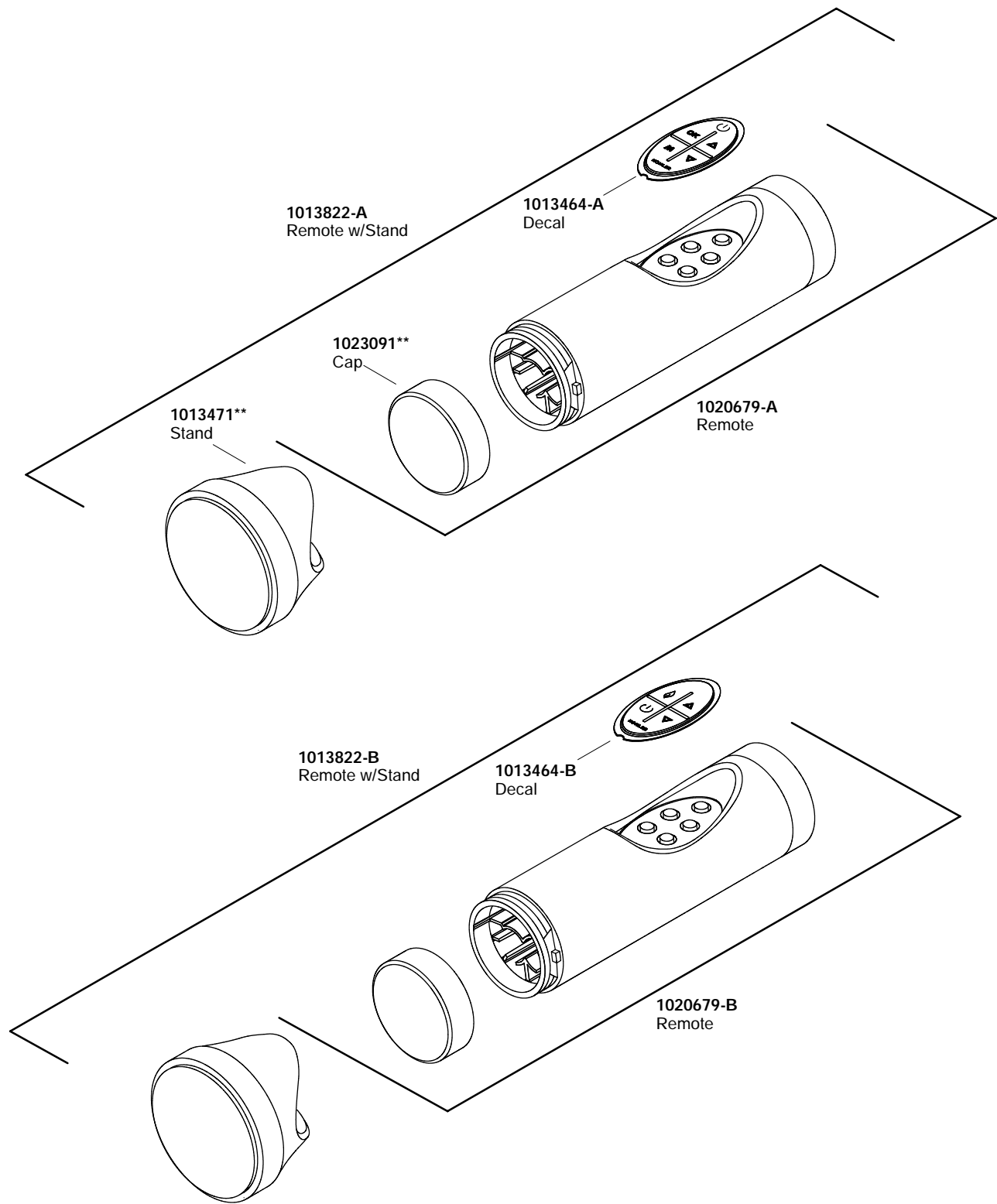

****Finish/color code must be specified when ordering.**

USA: 1-800-4-KOHLER
Canada: 1-800-964-5590
Mexico: 001-877-680-1310
kohler.com

THE BOLD LOOK
OF **KOHLER**®

©2003 Kohler Co.

1019473-5-A